



US00D830495S

(12) **United States Design Patent**  
**Covington**

(10) **Patent No.:** **US D830,495 S**  
(45) **Date of Patent:** **\*\* Oct. 9, 2018**

- (54) **HOOK**
- (71) Applicant: **MARSH TACKY COMPOSITES, LLC**, Murrells Inlet, SC (US)
- (72) Inventor: **Wesley Adair Covington**, Orangeburg, SC (US)
- (73) Assignee: **MARSH TACKY COMPOSITES, LLC**, Murrells Inlet, SC (US)
- (\*\*) Term: **15 Years**
- (21) Appl. No.: **29/582,220**
- (22) Filed: **Oct. 26, 2016**
- (51) **LOC (11) Cl.** ..... **22-05**
- (52) **U.S. Cl.**  
USPC ..... **D22/144**
- (58) **Field of Classification Search**  
USPC ..... D22/144, 149-150; 43/4-5, 17.2, 44.4, 43/44.81, 44.8, 43.16  
CPC ..... A01K 83/00; A01K 83/06; A01K 91/04  
See application file for complete search history.

- 5,097,622 A \* 3/1992 James ..... A01K 83/00 43/43.16
- D532,074 S \* 11/2006 Travis, Sr. .... D22/149
- D676,107 S \* 2/2013 Malcarne ..... D22/149
- D797,884 S \* 9/2017 Lee ..... D22/144

\* cited by examiner

*Primary Examiner* — Catherine R Oliver-Garcia  
(74) *Attorney, Agent, or Firm* — Moore & Van Allen PLLC; Nicholas C. Russell

(57) **CLAIM**

The ornamental design for a hook, as shown and described.

**DESCRIPTION**

FIG. 1 is a perspective view of a hook showing my new design;  
FIG. 2 is a front view of the hook of FIG. 1;  
FIG. 3 is a rear view of the hook of FIG. 1;  
FIG. 4 is a left side view of the hook of FIG. 1;  
FIG. 5 is a right side view of the hook of FIG. 1;  
FIG. 6 is a top view of the hook of FIG. 1;  
FIG. 7 is a bottom view of the hook of FIG. 1;  
FIG. 8 is a perspective view of the hook of FIG. 1; and,  
FIG. 9 is an enlarged view of the tip of the hook of FIG. 1.  
The broken line drawings of the images, text, and other elements shown in the figure are shown for illustrative purposes only and form no part of the claimed design. In addition, the surface shading, if any, illustrated in the drawings is provided merely to highlight the contour of the design; it is not intended to be illustrative of texture or gloss.

**1 Claim, 7 Drawing Sheets**

(56) **References Cited**

U.S. PATENT DOCUMENTS

- 2,841,914 A \* 7/1958 Butler ..... A01K 83/00 43/43.16
- 4,715,142 A \* 12/1987 Richard ..... A01K 83/00 43/43.16

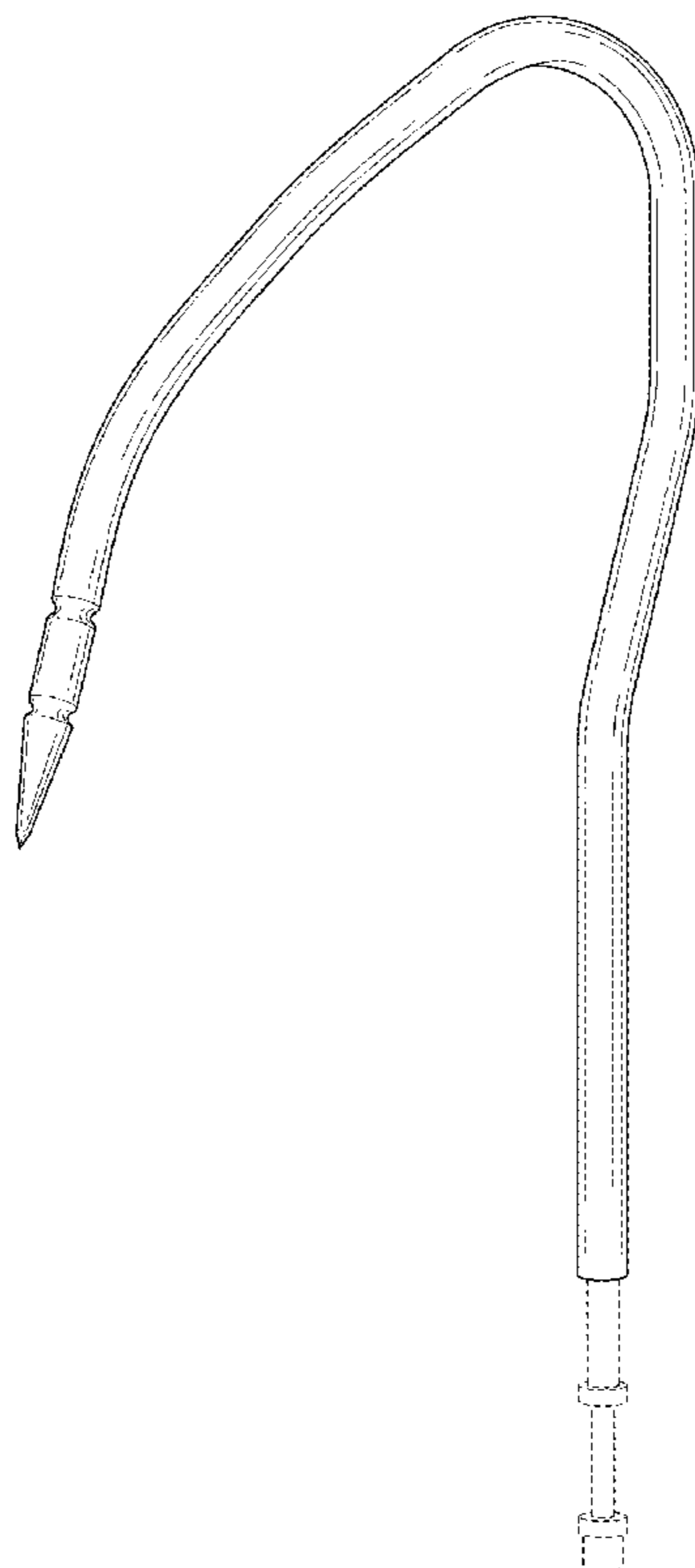

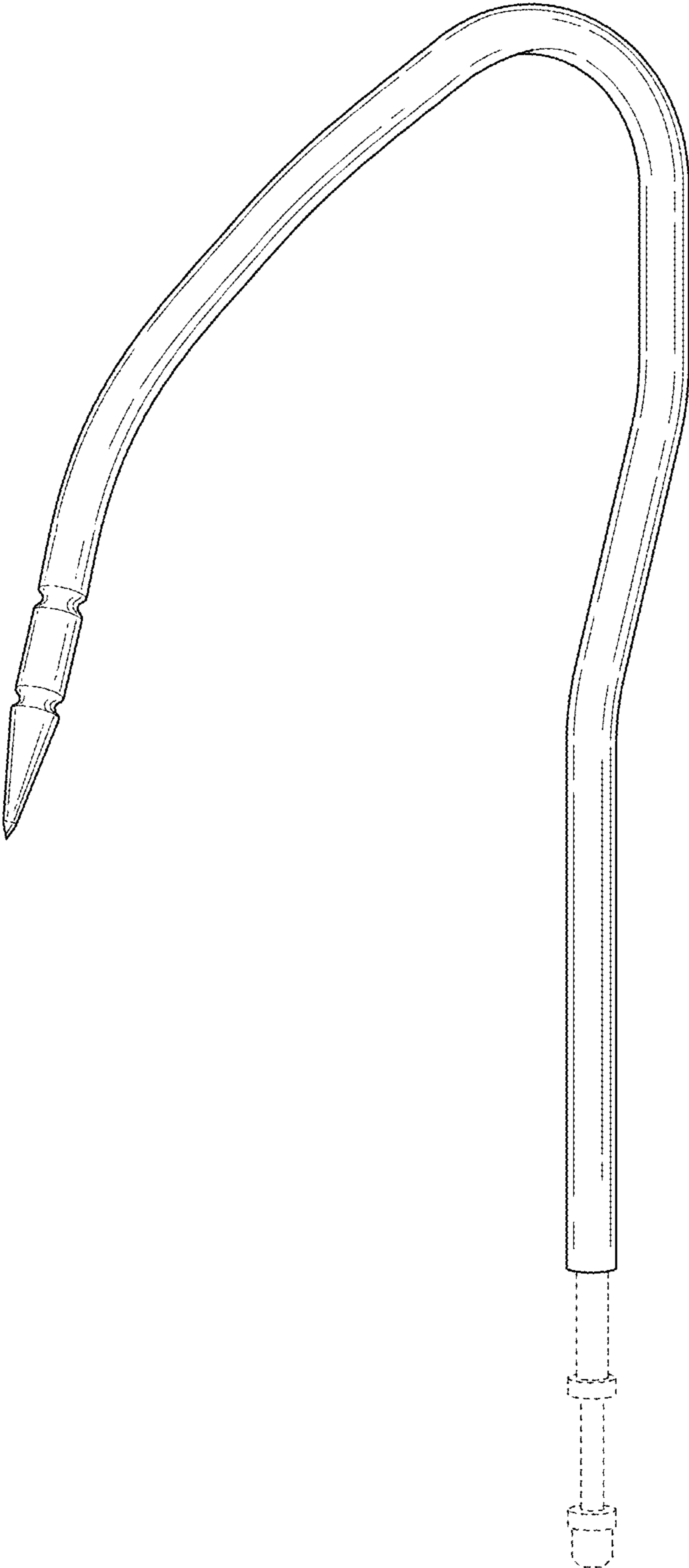
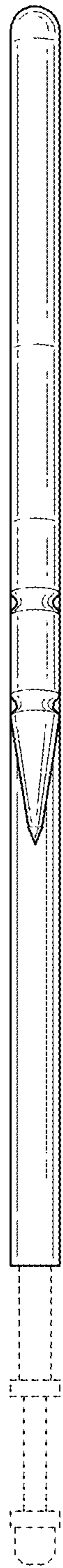
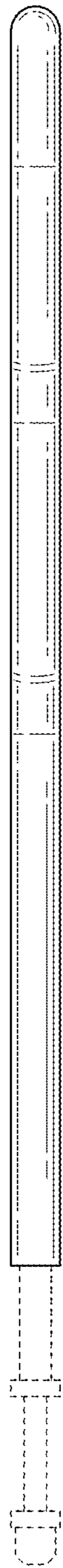

FIG. 1



**FIG. 2**



**FIG. 3**

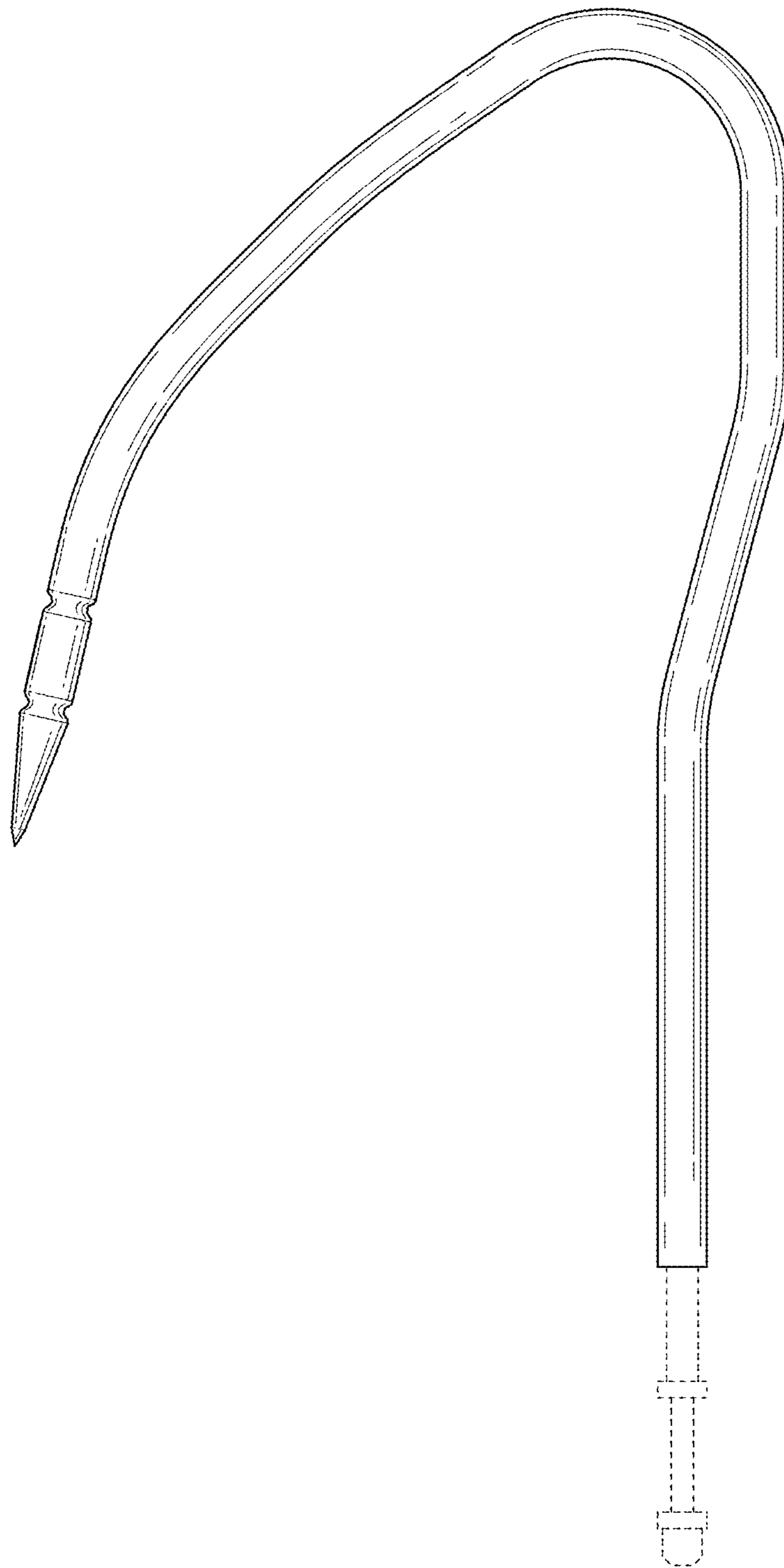

FIG. 4

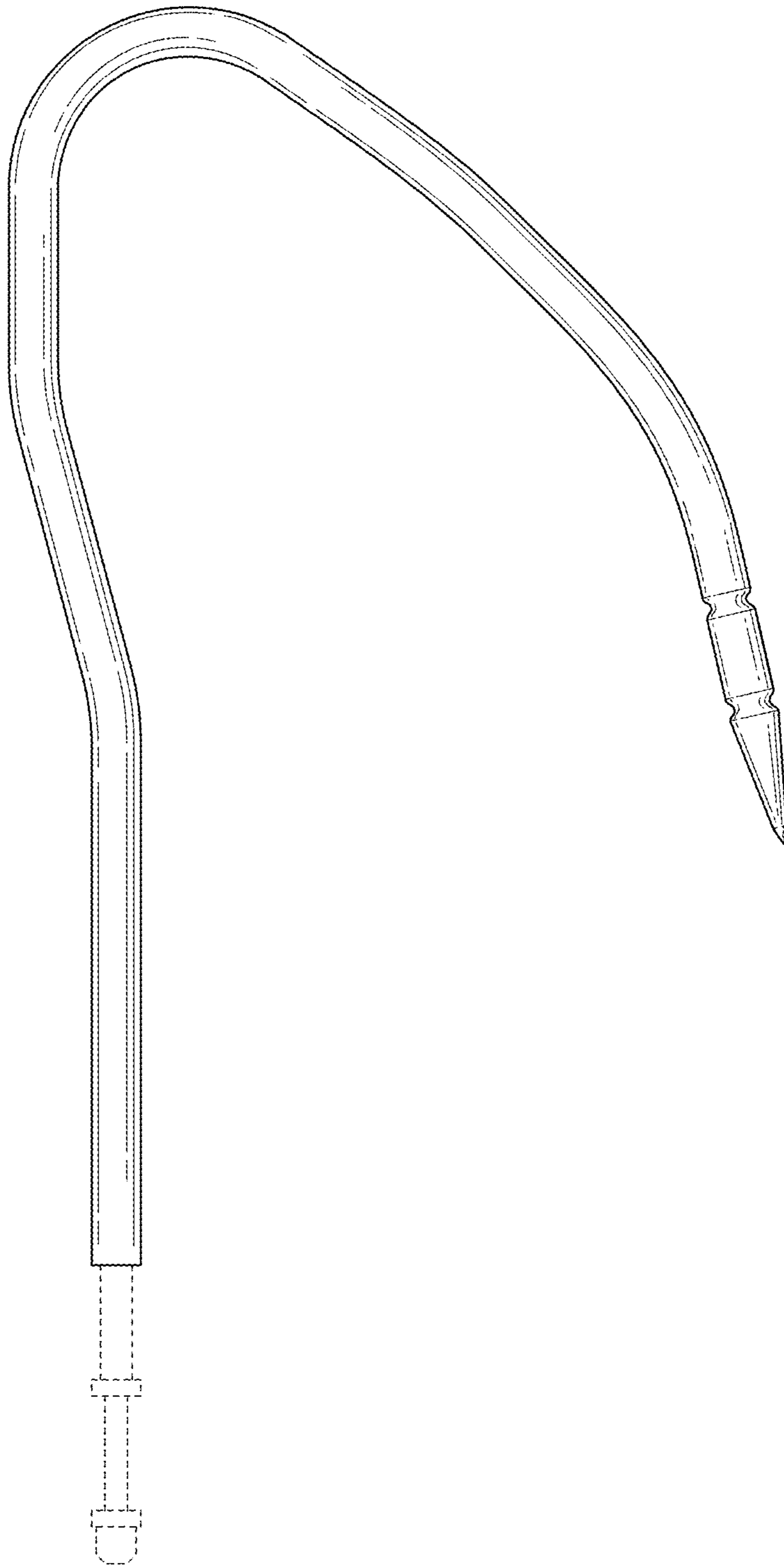
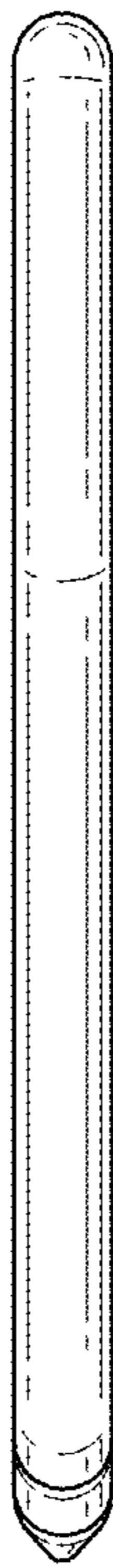
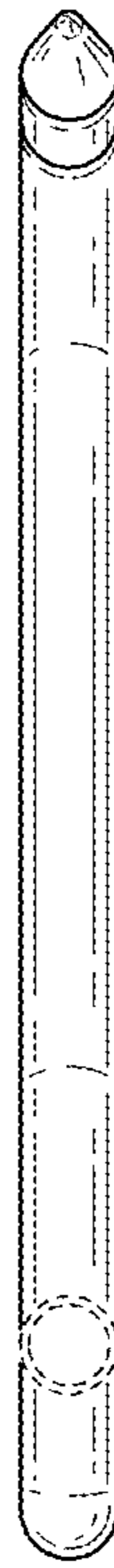

FIG. 5



**FIG. 6**



**FIG. 7**

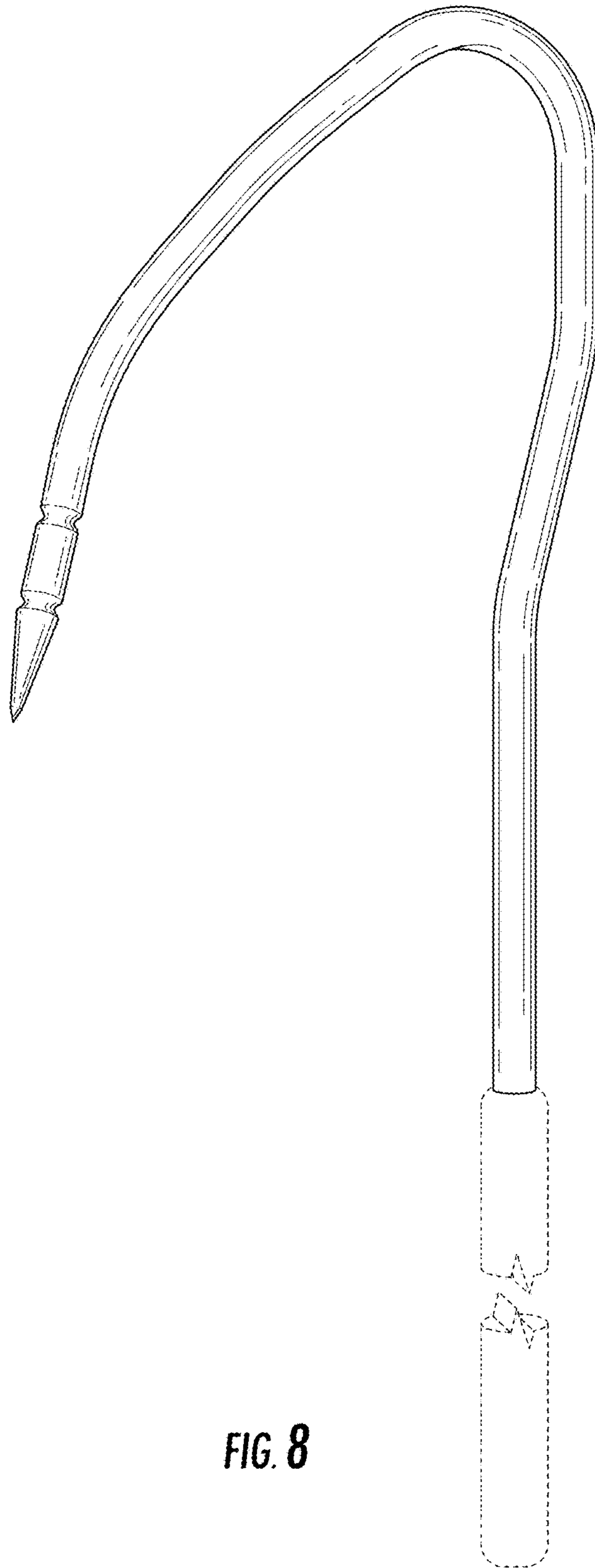
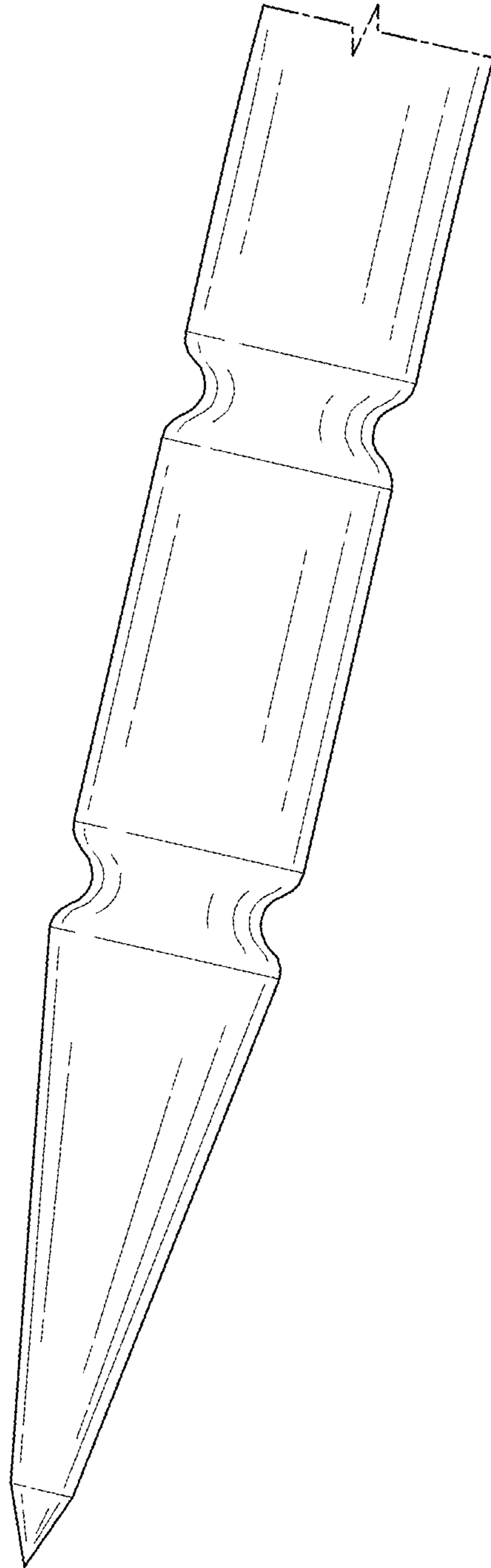

FIG. 8



**FIG. 9**