



US00D830456S

(12) **United States Design Patent** (10) **Patent No.:** **US D830,456 S**
Costas (45) **Date of Patent:** **** Oct. 9, 2018**

(54) **DRY ERASE BOARD WITH NOTE HOLDER**

D586,396 S 2/2009 Kang
D589,089 S 3/2009 Loerakker et al.
D589,560 S 3/2009 Beno et al.

(71) Applicant: **Trophius Pty Ltd.**, Cremorne (AU)

(Continued)

(72) Inventor: **Eric Costas**, Cremorne (AU)

FOREIGN PATENT DOCUMENTS

(73) Assignee: **Trophius Pty Ltd.**, Cremorne (AU)

AU 346443 1/2013
AU 346543 1/2013

(**) Term: **15 Years**

OTHER PUBLICATIONS

(21) Appl. No.: **29/584,509**

(22) Filed: **Nov. 15, 2016**

(51) **LOC (11) Cl.** **19-06**

(52) **U.S. Cl.**
USPC **D19/113**

(58) **Field of Classification Search**

USPC D8/349, 394, 395; D19/113, 114, 75, 77,
D19/20, 21, 22, 1, 2, 100, 101, 102, 65,
D19/86, 88, 90, 91; D20/10, 19, 27, 39,
D20/41; D6/300; D14/448
CPC B43L 1/00; B43L 1/04; B43L 1/06; B43L
1/10; B43L 3/00; B43L 3/008; B43L
5/00; G06F 15/00; G06F 15/0006; G06F
15/0018; G06F 15/0056; G09F 15/00;
G09F 15/0018; F16B 5/121

See application file for complete search history.

“Office Depot Brand 4-Piece Stainless Steel Magnet Hook Set, Assorted Shapes (No Shape Choice)”; Office Depot; disclosure date unknown but prior to date of filing the present application; URL: <<http://www.officedepot.com/a/products/352108/Office-Depot-Brand-4-Piece-Stainless/>>.

Primary Examiner — Derrick Holland

Assistant Examiner — Andrew Kerr

(74) *Attorney, Agent, or Firm* — Banner & Witcoff, Ltd.

(57) **CLAIM**

The ornamental design for a dry erase board with note holder, as shown and described.

DESCRIPTION

FIG. 1 is a front perspective view of a dry erase board with note holder showing my new design; FIG. 2 is a front view thereof; FIG. 3 is a right side view thereof; FIG. 4 is a left side view thereof; FIG. 5 is a top view thereof; and, FIG. 6 is a bottom view thereof.

The broken lines immediately adjacent to the shaded areas of the dry erase board with note holder define the bounds of the claimed design and form no part thereof. All other broken lines represent environmental structure and form no part of the claimed design. The dry erase board with note holder is shown with a symbolic break in its length. The appearance of any portion of the article between the break lines forms no part of the claimed design.

1 Claim, 4 Drawing Sheets

(56) **References Cited**

U.S. PATENT DOCUMENTS

D251,124 S 2/1979 Takeuchi
D327,095 S 6/1992 Meyer
5,176,522 A * 1/1993 Robertson, Jr. B43L 1/00
434/408
D451,134 S 11/2001 Fonfeder
D487,289 S 3/2004 Richter
D496,068 S 9/2004 Mandel
D507,302 S 7/2005 Chen et al.
D507,812 S * 7/2005 Cesaroni D19/113
D521,068 S 5/2006 Newbould
7,040,051 B2 5/2006 Windorski

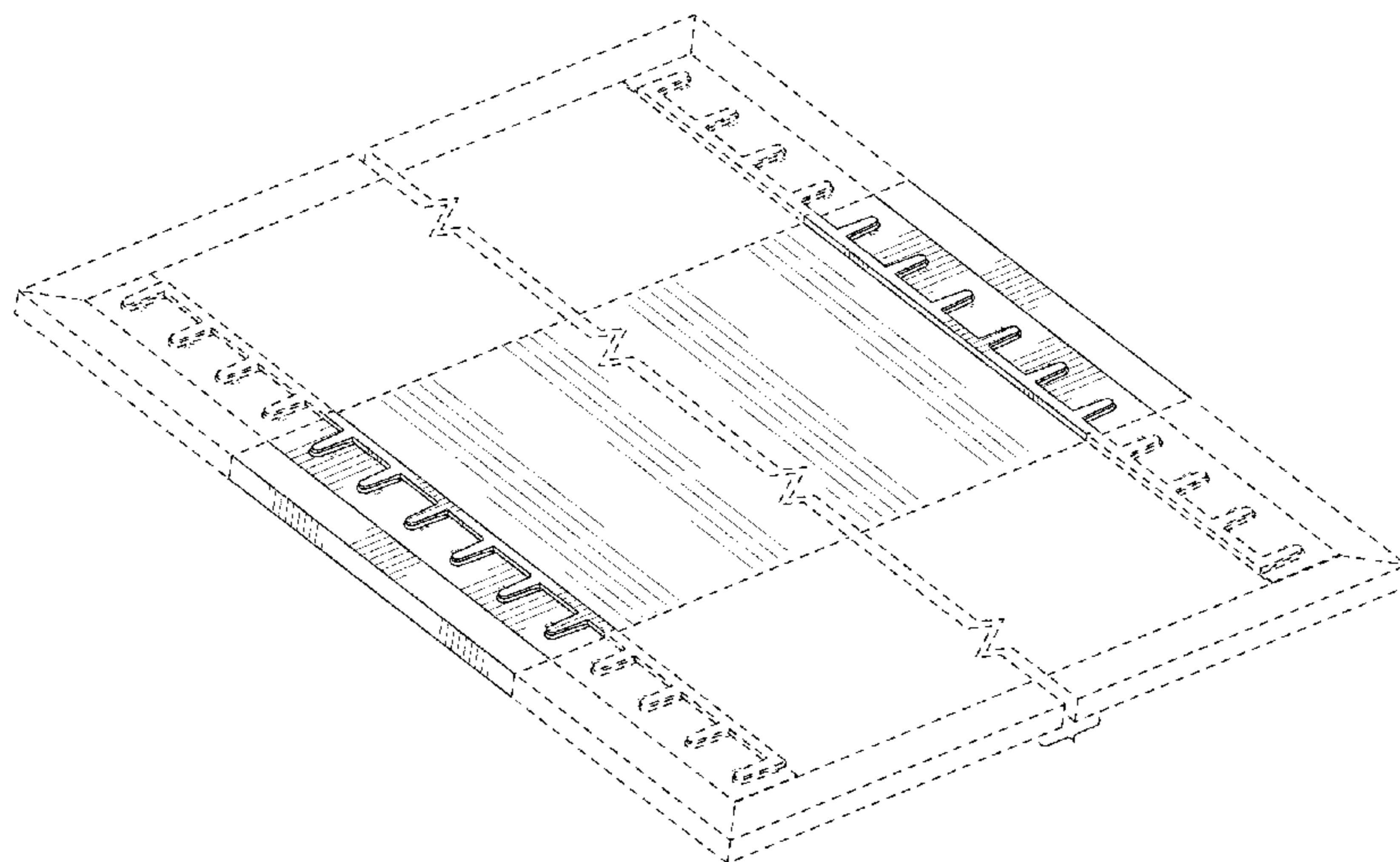

(56)

References Cited

U.S. PATENT DOCUMENTS

D607,058	S	*	12/2009	Kim	D19/86
D617,565	S	*	6/2010	Mischel, Jr.	D6/300
D623,227	S	*	9/2010	Hoch	D19/113
D623,693	S	*	9/2010	Hoch	D19/113
7,874,842	B2		1/2011	Beno	
D645,515	S		9/2011	Williams, Sr.	
D667,413	S	*	9/2012	Song	D14/448
D669,532	S		10/2012	Killian	
D715,859	S		10/2014	Costas	
D715,860	S		10/2014	Costas	
D715,861	S		10/2014	Costas	
D716,377	S		10/2014	Costas	
D719,217	S		12/2014	Costas	
D719,218	S		12/2014	Costas	
9,090,116	B2	*	7/2015	Tunis	F41H 5/08
D752,145	S		3/2016	Killian	
D753,222	S		4/2016	Costas	
D755,892	S		5/2016	Costas	
D776,759	S		1/2017	Costas	
D778,356	S		2/2017	Costas	
D794,121	S		8/2017	Costas	
D794,122	S		8/2017	Costas	
D794,123	S		8/2017	Costas	
D794,124	S		8/2017	Costas	
D794,125	S		8/2017	Costas	
D809,599	S	*	2/2018	Costas	D19/113
D811,478	S	*	2/2018	Costas	D19/86
D818,357	S	*	5/2018	Cummings	D8/394
2013/0200228	A1		8/2013	Costas	

* cited by examiner

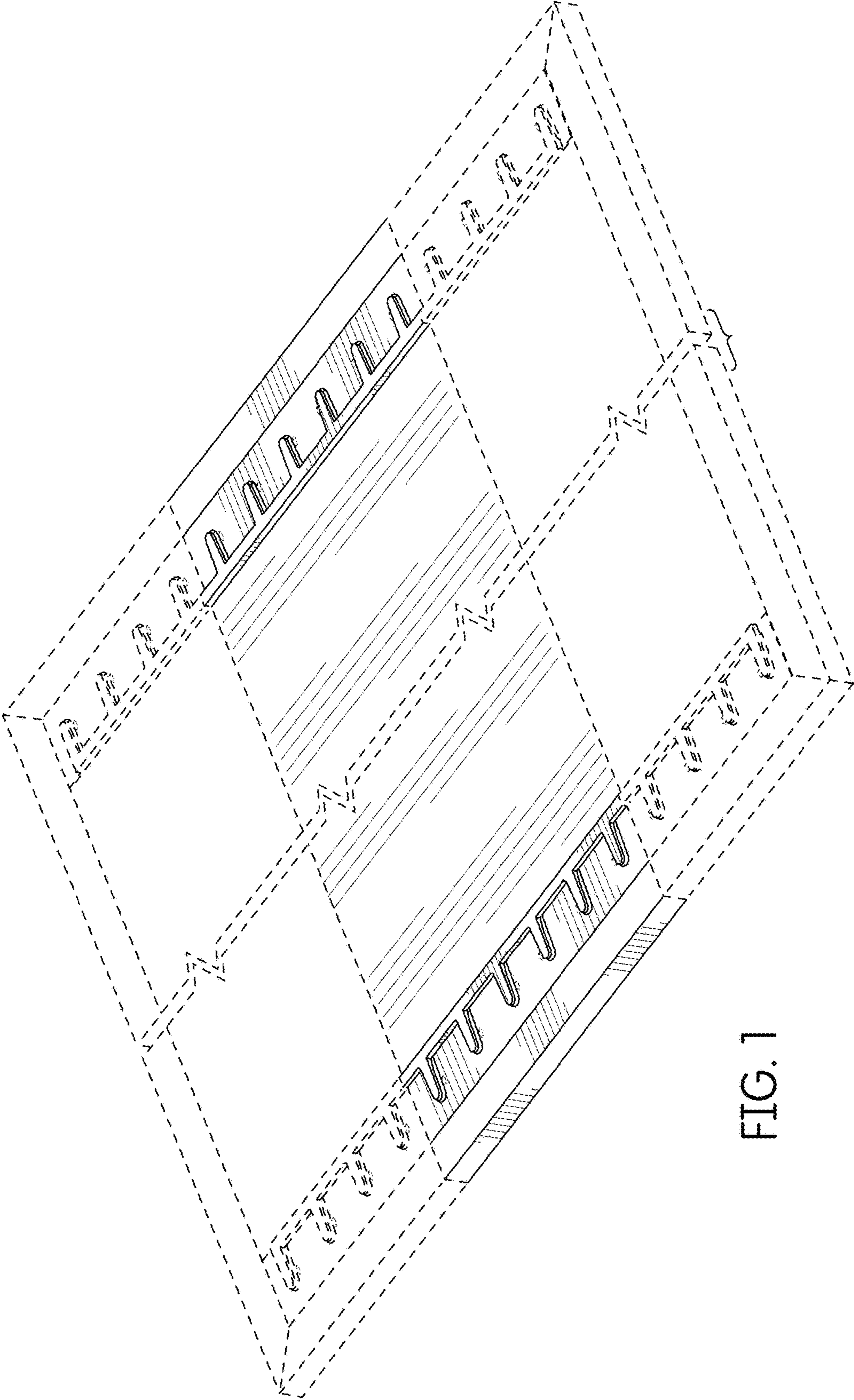

FIG. 1

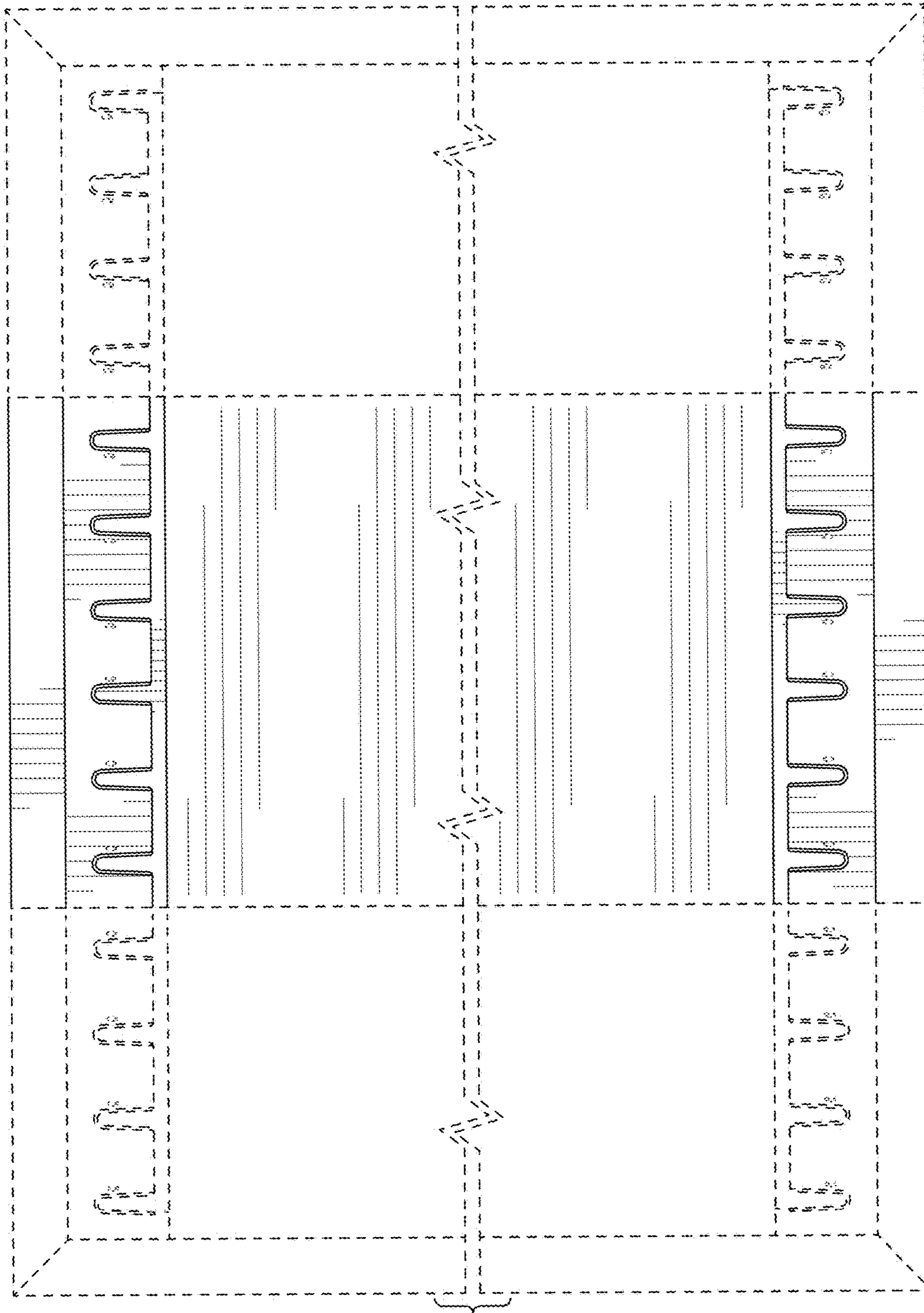

FIG. 2

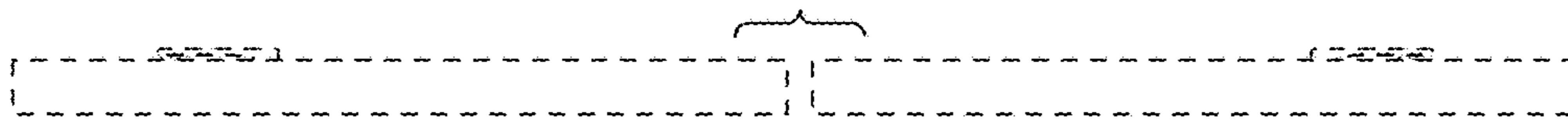

FIG. 4

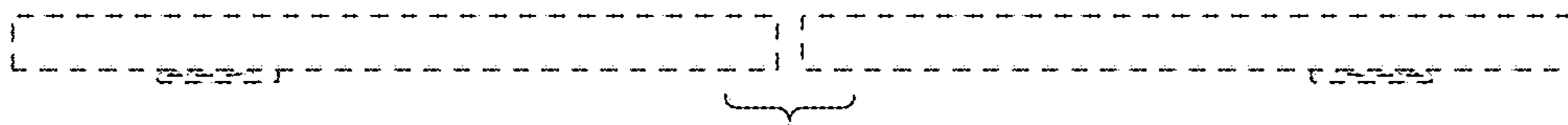

FIG. 3

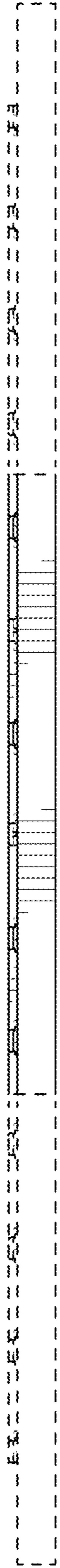

FIG. 5

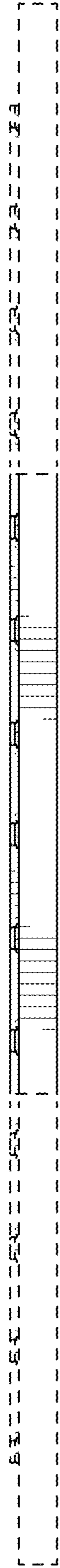

FIG. 6