



US00D830455S

(12) **United States Design Patent** (10) **Patent No.:** **US D830,455 S**  
**Costas** (45) **Date of Patent:** **\*\* Oct. 9, 2018**

(54) **DRY ERASE BOARD WITH NOTE HOLDER**

FOREIGN PATENT DOCUMENTS

(71) Applicant: **Trophius Pty Ltd.**, Cremorne (AU)

AU 346443 1/2013  
AU 346543 1/2013

(72) Inventor: **Eric Costas**, Cremorne (AU)

(73) Assignee: **Trophius Pty Ltd.**, Cremorne (AU)

(\*\*) Term: **15 Years**

(21) Appl. No.: **29/584,503**

(22) Filed: **Nov. 15, 2016**

(51) **LOC (11) Cl.** ..... **19-06**

(52) **U.S. Cl.**  
USPC ..... **D19/113**

(58) **Field of Classification Search**  
USPC .... D8/349, 394, 395; D19/113, 114, 75, 77,  
D19/20, 21, 22, 1, 2, 100, 101, 102, 65,  
D19/86, 88, 90, 91; D20/10, 19, 27, 39,  
D20/41; D6/300; D14/448  
CPC ..... B43L 1/00; B43L 1/04; B43L 1/06; B43L  
1/10; B43L 3/00; B43L 3/008; B43L  
5/00; G06F 15/00; G06F 15/0006; G06F  
15/0018; G06F 15/0056; G09F 15/00;  
G09F 15/0018; F16B 5/121  
See application file for complete search history.

(56) **References Cited**

U.S. PATENT DOCUMENTS

D251,124 S 2/1979 Takeuchi  
D327,095 S 6/1992 Meyer  
5,176,522 A \* 1/1993 Robertson, Jr. .... B43L 1/00  
434/408  
D451,134 S 11/2001 Fonfeder  
D487,289 S 3/2004 Richter  
D496,068 S 9/2004 Mandel  
D507,302 S 7/2005 Chen et al.  
D507,812 S \* 7/2005 Cesaroni ..... D19/113  
D521,068 S 5/2006 Newbould  
7,040,051 B2 5/2006 Windorski  
D586,396 S 2/2009 Kang  
D589,089 S 3/2009 Loerakker et al.  
D589,560 S 3/2009 Beno et al.

(Continued)

OTHER PUBLICATIONS

“Office Depot Brand 4-Piece Stainless Steel Magnet Hook Set, Assorted Shapes (No Shape Choice)”; Office Depot; disclosure date unknown but prior to date of filing the present application; URL: <<http://www.officedepot.com/a/products/352108/Office-Depot-Brand-4-Piece-Stainless/>>.

*Primary Examiner* — Derrick Holland

*Assistant Examiner* — Andrew Kerr

(74) *Attorney, Agent, or Firm* — Banner & Witcoff, Ltd.

(57) **CLAIM**

The ornamental design for a dry erase board with note holder, as shown and described.

**DESCRIPTION**

FIG. 1 is a front perspective view of a dry erase board with note holder showing my new design; FIG. 2 is a front view thereof; FIG. 3 is a bottom view thereof; FIG. 4 is a top view thereof; FIG. 5 is a right side view thereof; and, FIG. 6 is a left side view thereof.

The broken lines immediately adjacent to the shaded areas of the dry erase board with note holder define the bounds of the claimed design and form no part thereof. All other broken lines represent environmental structure and form no part of the claimed design.

The dry erase board with note holder is shown with a symbolic break in its length and width. The appearance of any portion of the article between the break lines forms no part of the claimed design.

**1 Claim, 4 Drawing Sheets**

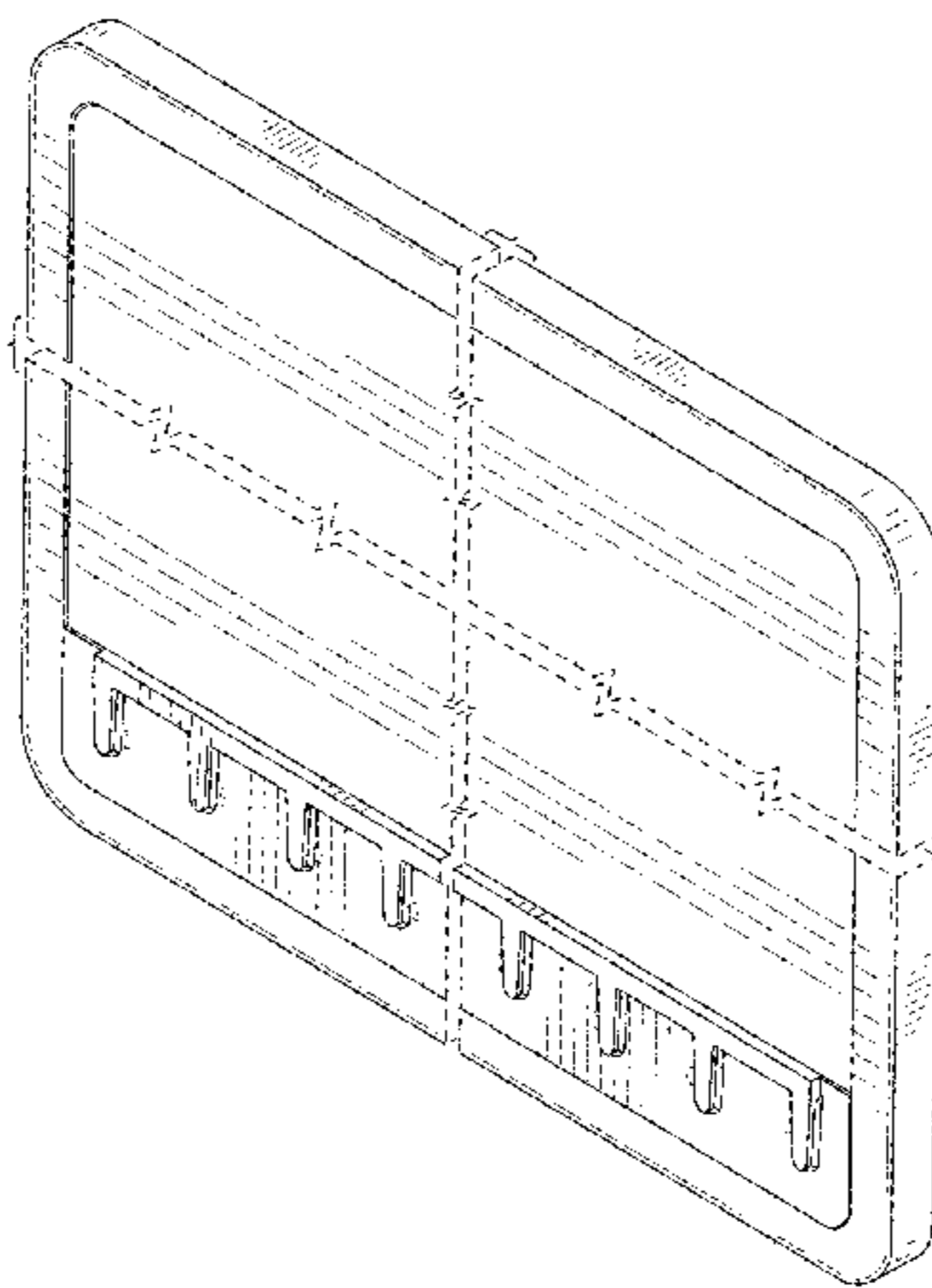

(56)

**References Cited**

U.S. PATENT DOCUMENTS

D607,058	S	*	12/2009	Kim .....	D19/86
D617,565	S	*	6/2010	Mischel, Jr. ....	D6/300
D623,227	S	*	9/2010	Hoch .....	D19/113
D623,693	S	*	9/2010	Hoch .....	D19/113
7,874,842	B2		1/2011	Beno	
D645,515	S		9/2011	Williams, Sr.	
D667,413	S	*	9/2012	Song .....	D14/448
D669,532	S		10/2012	Killian	
D715,859	S		10/2014	Costas	
D715,860	S		10/2014	Costas	
D715,861	S		10/2014	Costas	
D716,377	S		10/2014	Costas	
D719,217	S		12/2014	Costas	
D719,218	S		12/2014	Costas	
9,090,116	B2	*	7/2015	Tunis .....	F41H 5/08
D752,145	S		3/2016	Killian	
D753,222	S		4/2016	Costas	
D755,892	S		5/2016	Costas	
D776,759	S		1/2017	Costas	
D778,356	S		2/2017	Costas	
D794,121	S		8/2017	Costas	
D794,122	S		8/2017	Costas	
D794,123	S		8/2017	Costas	
D794,124	S		8/2017	Costas	
D794,125	S		8/2017	Costas	
D809,599	S	*	2/2018	Costas .....	D19/113
D811,478	S	*	2/2018	Costas .....	D19/86
D818,357	S	*	5/2018	Cummings .....	D8/394
2013/0200228	A1		8/2013	Costas	

\* cited by examiner

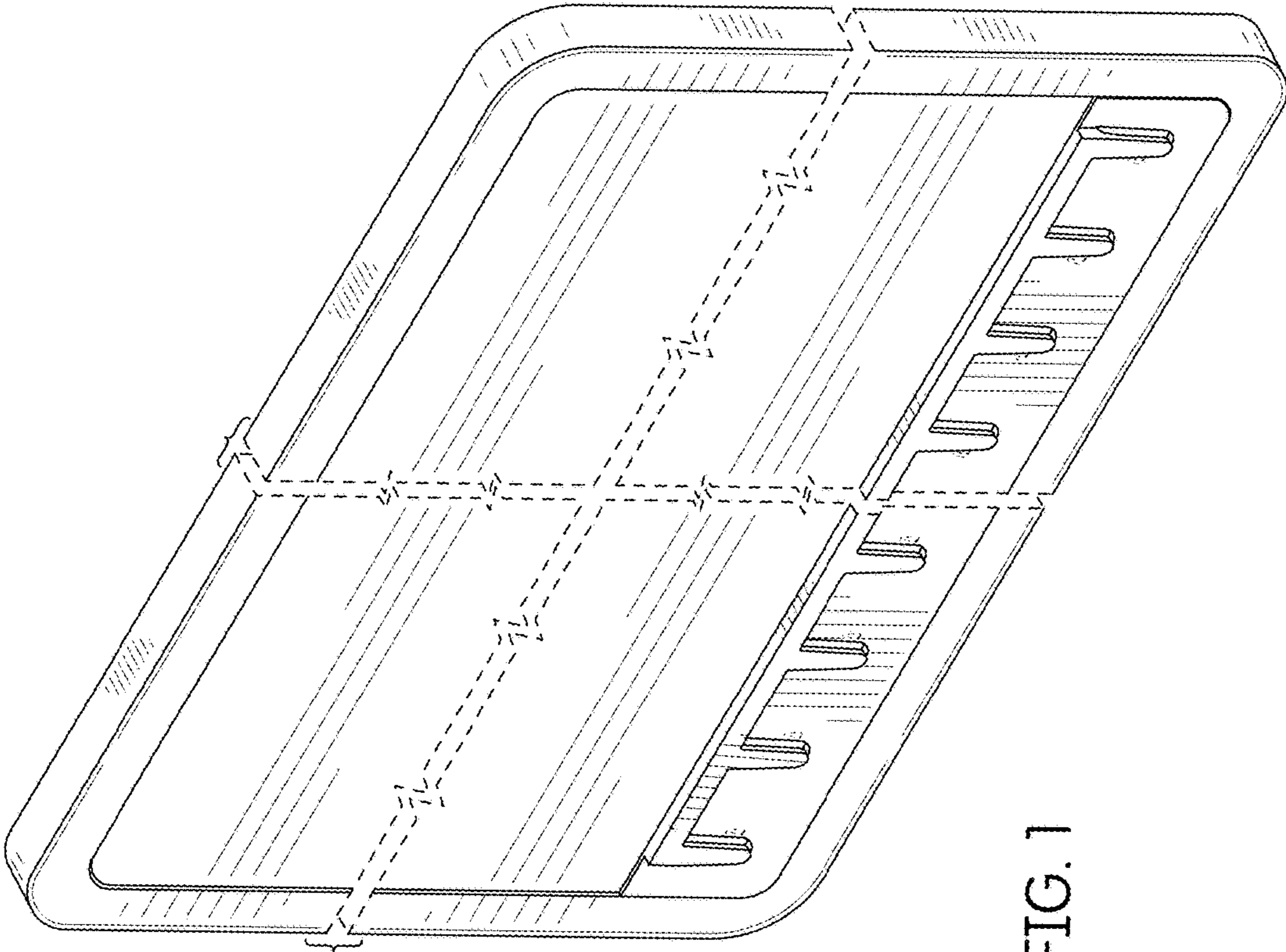

FIG. 1

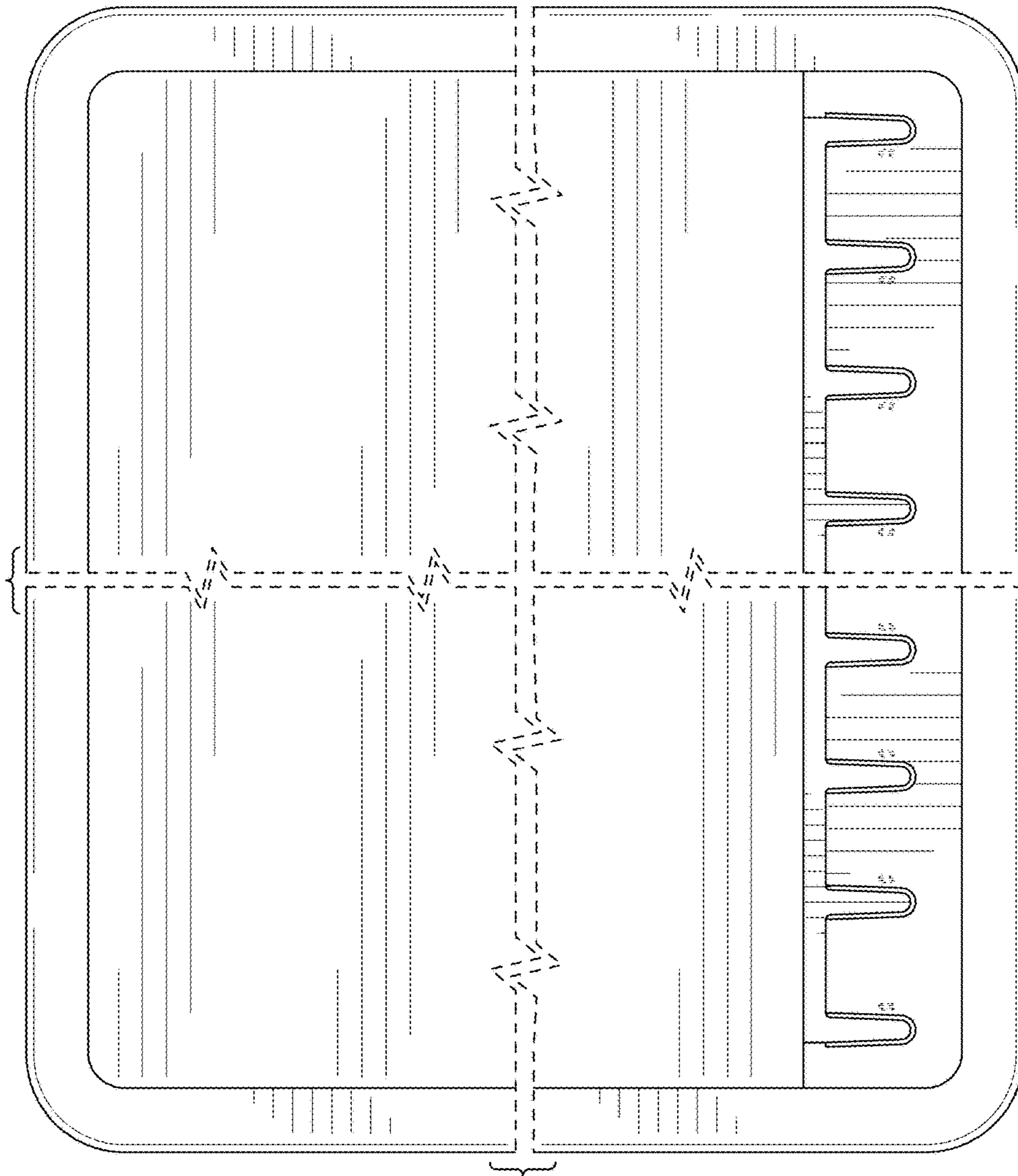

FIG. 2

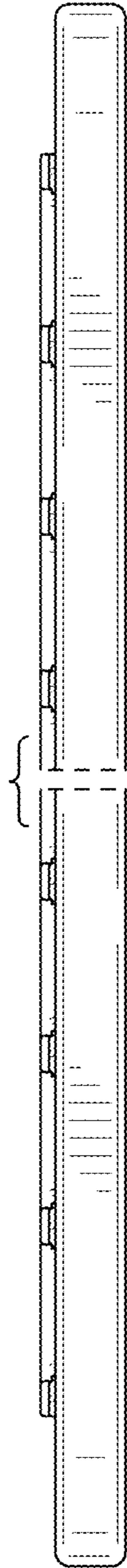

FIG. 3

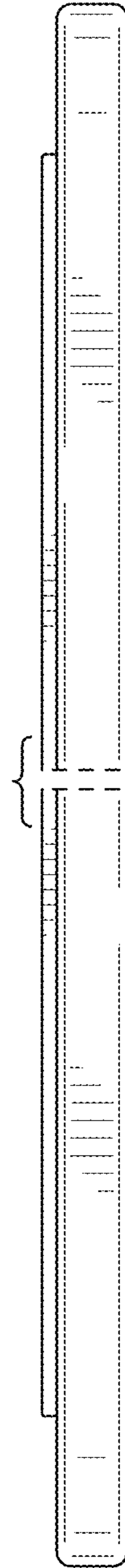

FIG. 4

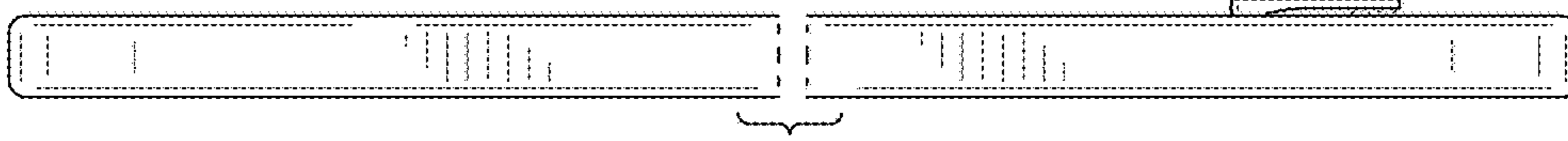

FIG. 6

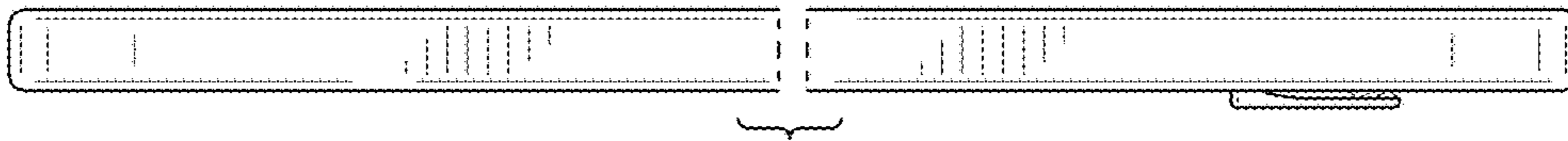

FIG. 5