



US00D830323S

(12) **United States Design Patent**
Huang

(10) **Patent No.:** **US D830,323 S**

(45) **Date of Patent:** **** *Oct. 9, 2018**

(54) **MULTIMEDIA DISPLAY**

(71) Applicant: **Fu-Lung Huang**, Tainan (TW)

(72) Inventor: **Fu-Lung Huang**, Tainan (TW)

(73) Assignee: **LWO Technology Co. Ltd.**, Tainan (TW)

(*) Notice: This patent is subject to a terminal disclaimer.

(**) Term: **15 Years**

(21) Appl. No.: **29/545,214**

(22) Filed: **Nov. 10, 2015**

(30) **Foreign Application Priority Data**

May 29, 2015 (TW) 104302882

(51) **LOC (11) Cl.** **14-03**

(52) **U.S. Cl.**
USPC **D14/127; D14/126**

(58) **Field of Classification Search**
USPC D14/125-134, 239, 371, 136, 374-377, D14/440, 450, 448, 336, 342, 159; 312/7.2; 348/836, 838, 180, 184, 325, 348/739; 248/917-924, 465; 345/104, 345/133, 156, 168, 87, 173; D21/329, D21/515, 577, 622, 333, 433, 448, 452, D21/450, 331, 505; D10/15, 26; 446/484, 175, 356; D6/477, 479, 300; D20/10, 19, 39; D16/203, 241; 160/24
CPC ... G06F 1/1601; G06F 1/1643; H05K 5/0004; H05K 5/0017; H05K 5/02; H05K 5/0217; H04N 13/0459

See application file for complete search history.

(56) **References Cited**

U.S. PATENT DOCUMENTS

D627,749 S *	11/2010	Mitsubishi	D14/126
D630,599 S *	1/2011	Lim	D14/126
D677,637 S *	3/2013	Kubota	D14/126
D680,088 S *	4/2013	Park	D14/126
D730,852 S *	6/2015	Park	D14/126
D737,234 S *	8/2015	Kim	D14/126
D742,375 S *	11/2015	Kang	D14/126
D756,945 S *	5/2016	Kim	D14/126
D761,222 S *	7/2016	Yoo	D14/126

* cited by examiner

Primary Examiner — Raphael Barkai

(74) *Attorney, Agent, or Firm* — Che-Yang Chen; Law Offices of Scott Warmuth

(57) **CLAIM**

The ornamental design for a multimedia display, as shown and described.

DESCRIPTION

FIG. 1 is a perspective view of a multimedia display showing my new design;

FIG. 2 is a front elevational view thereof;

FIG. 3 is a rear elevational view thereof;

FIG. 4 is a left side elevational view thereof;

FIG. 5 is a right side elevational view thereof;

FIG. 6 is a top plan view thereof; and,

FIG. 7 is a bottom plan view thereof.

1 Claim, 6 Drawing Sheets

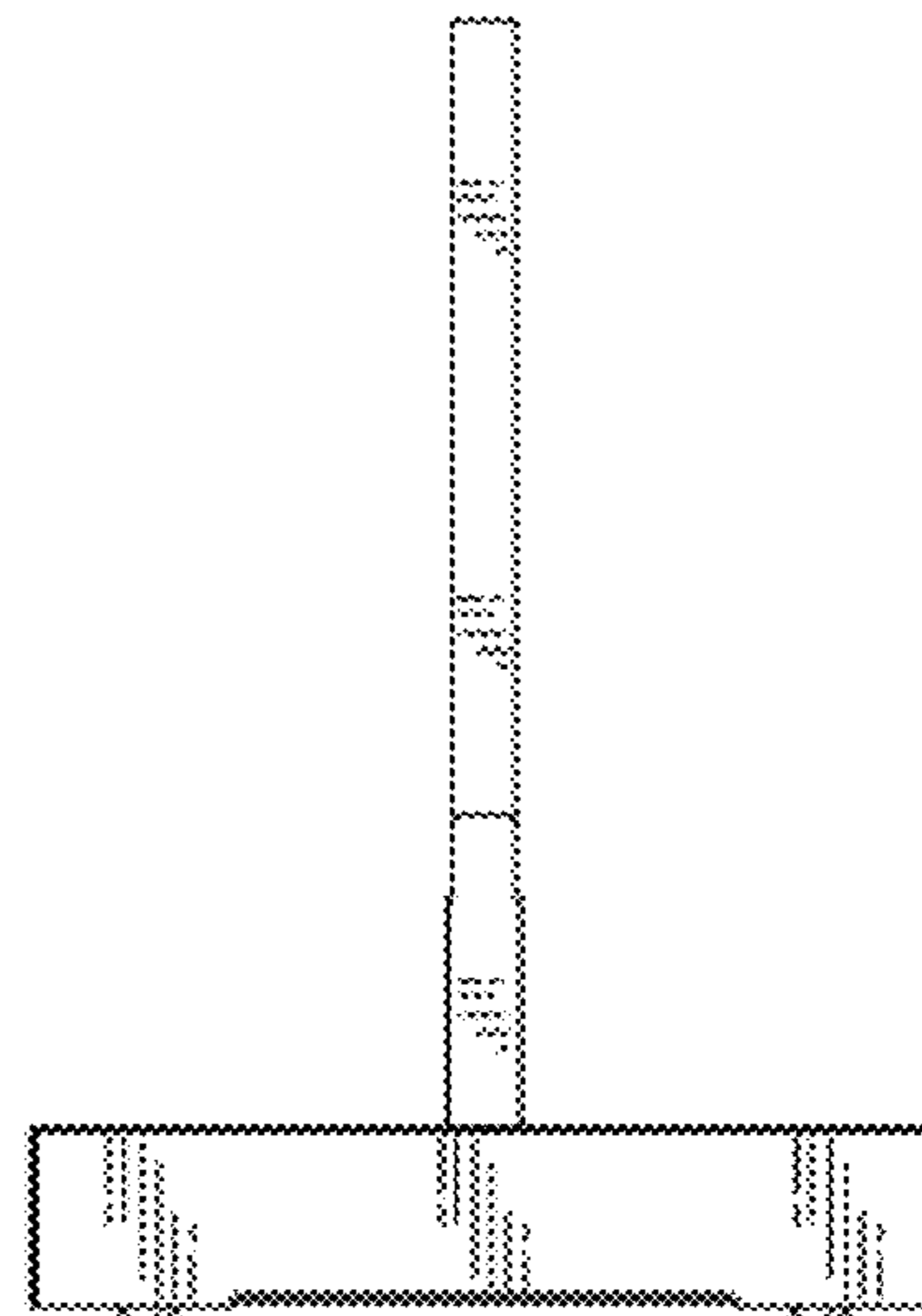
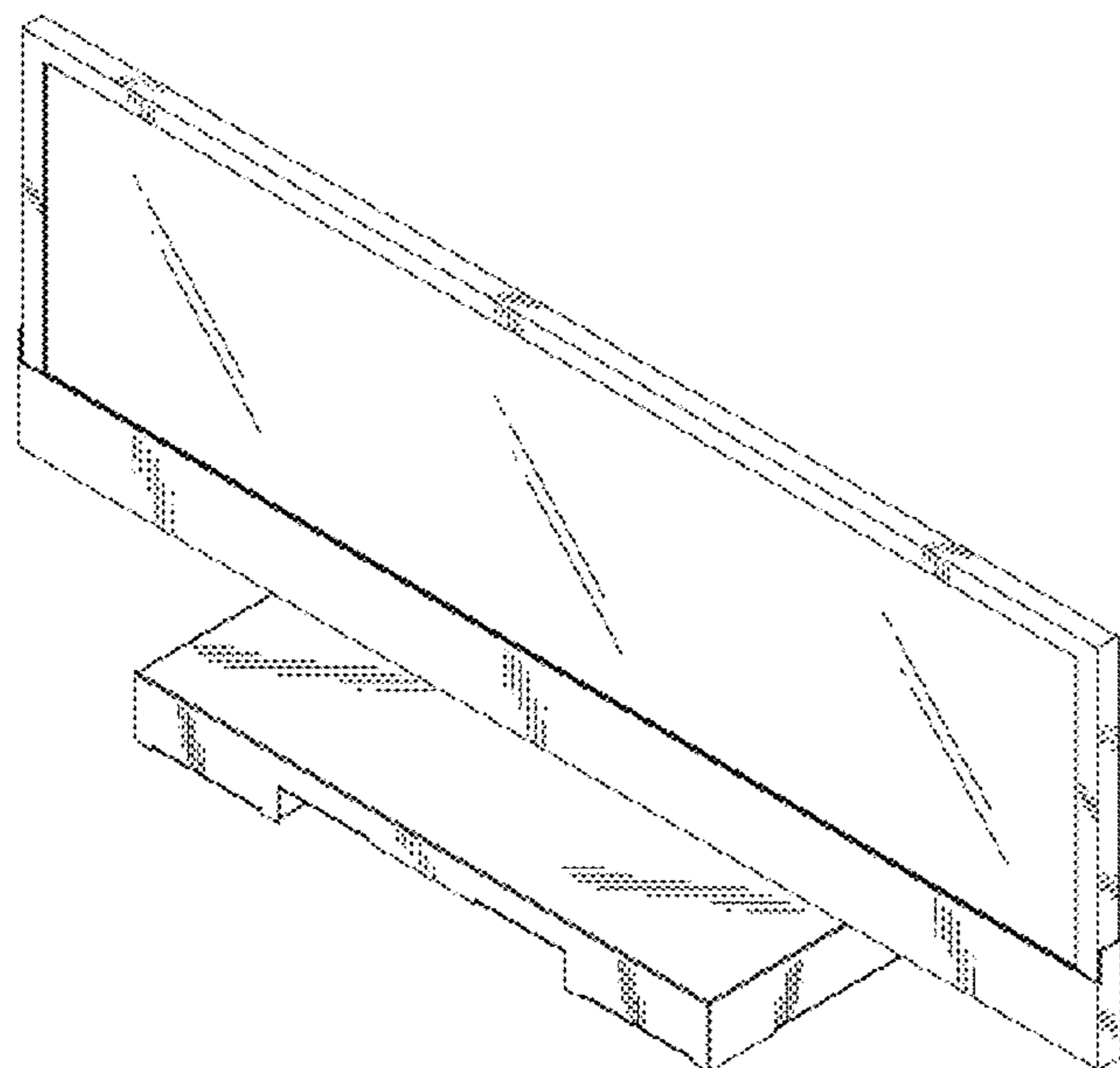

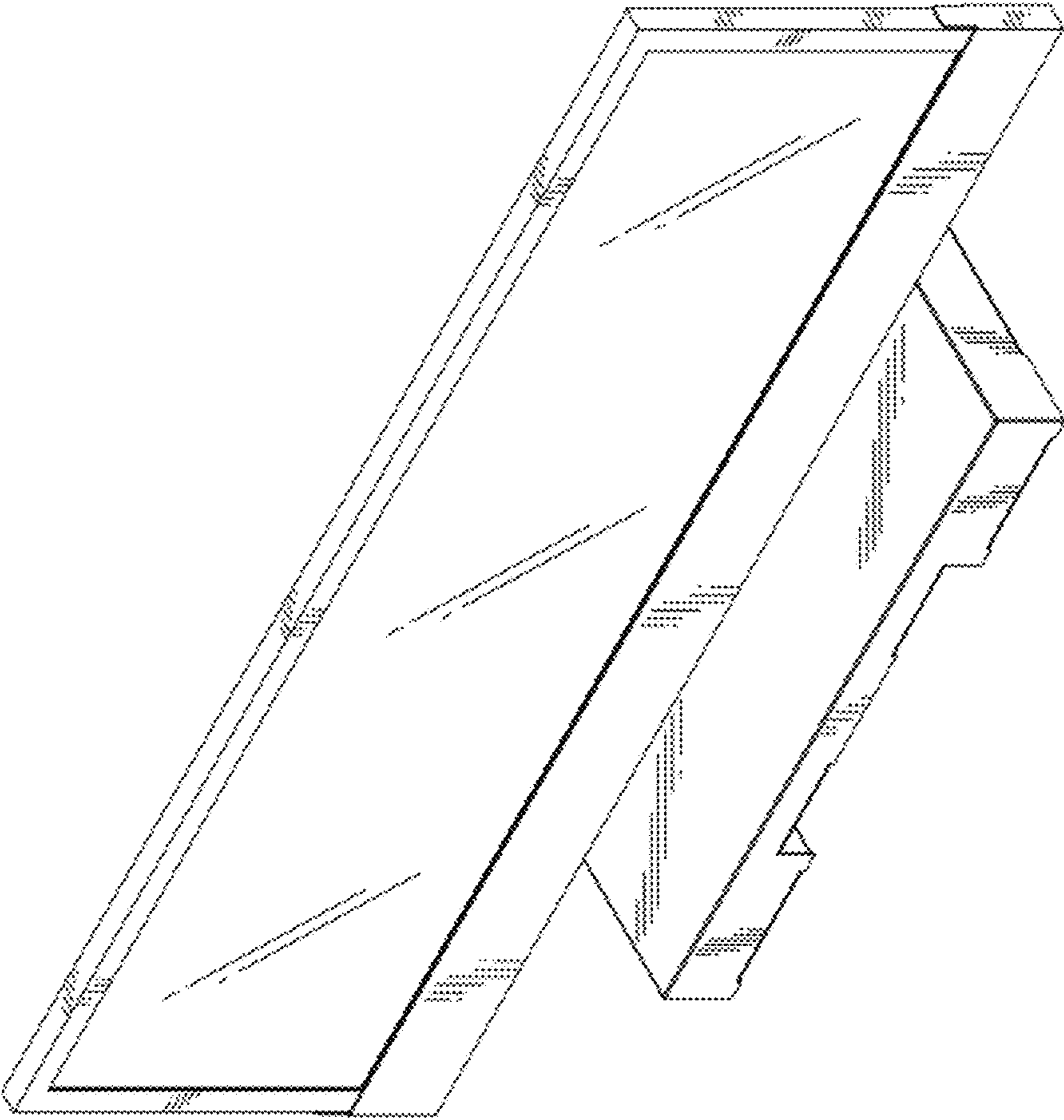

FIG. 1

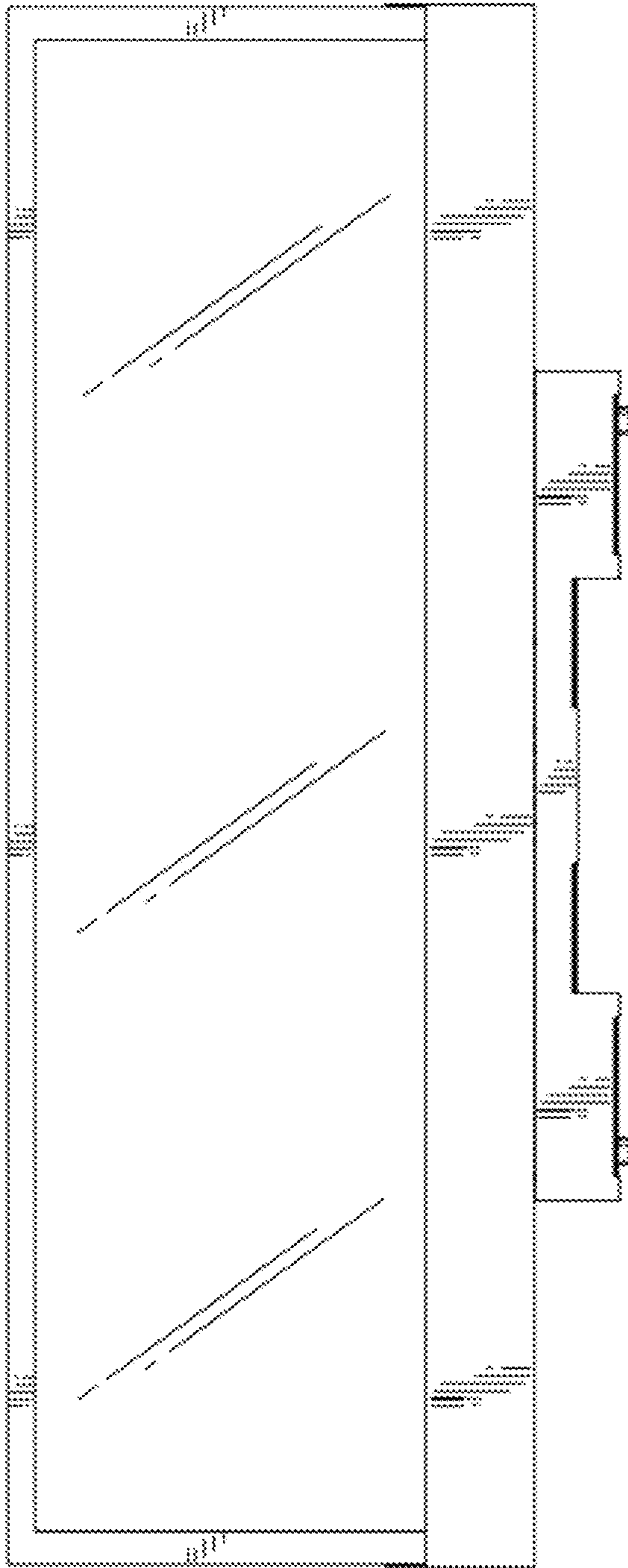

FIG. 2

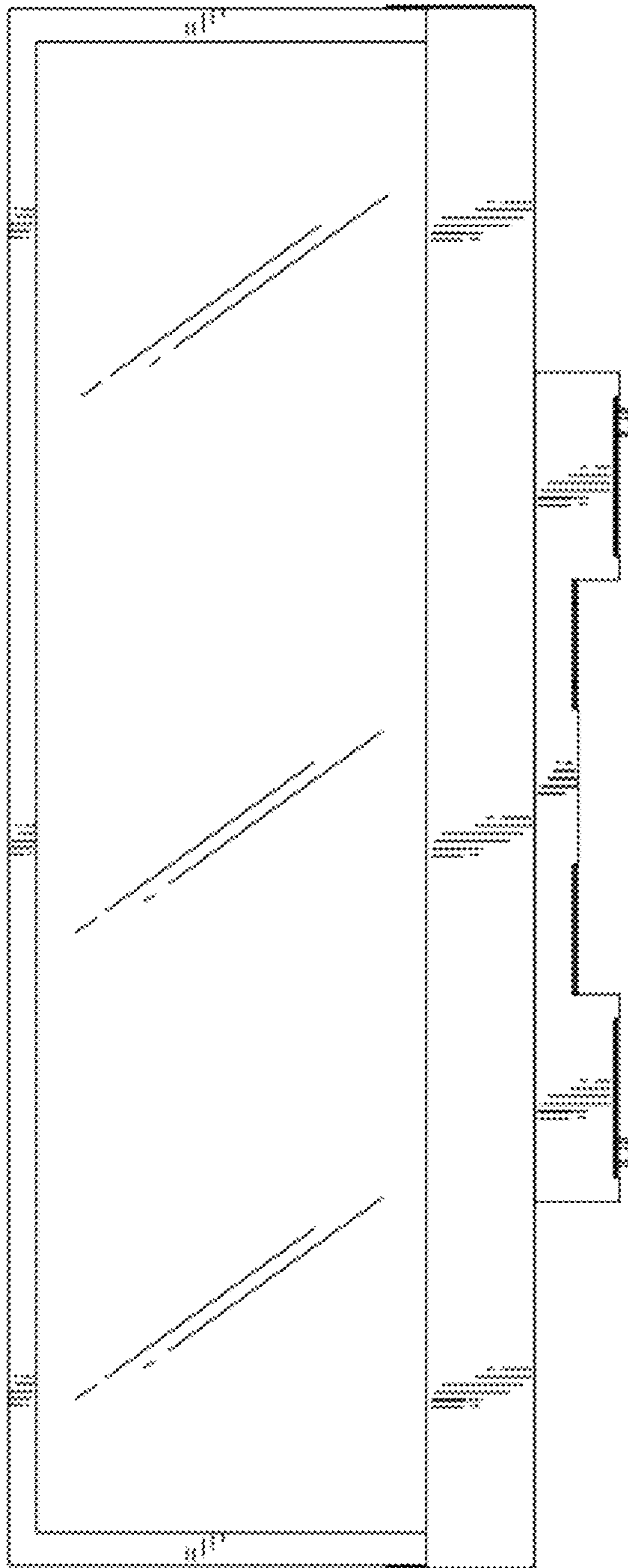

FIG. 3

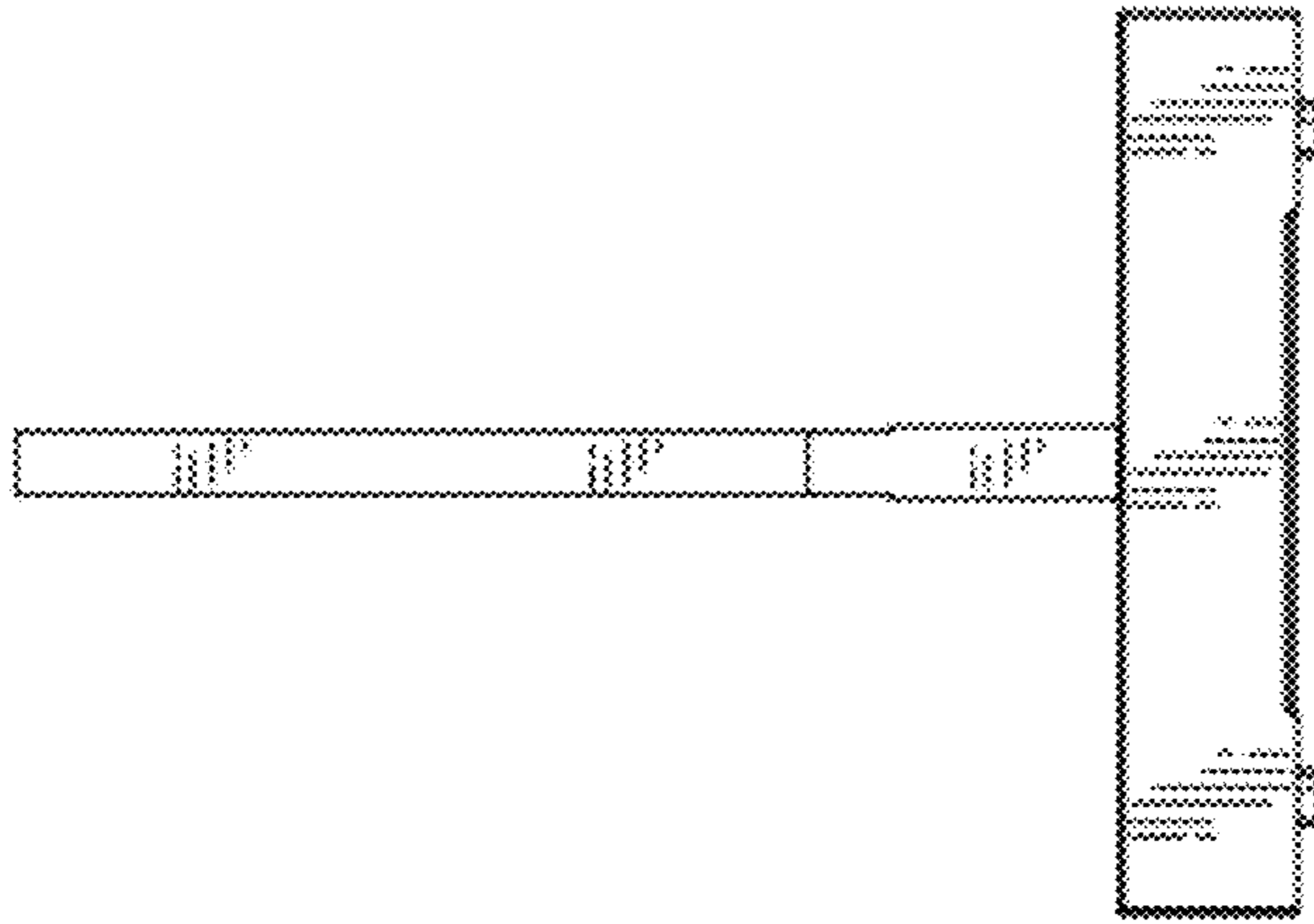

FIG. 5

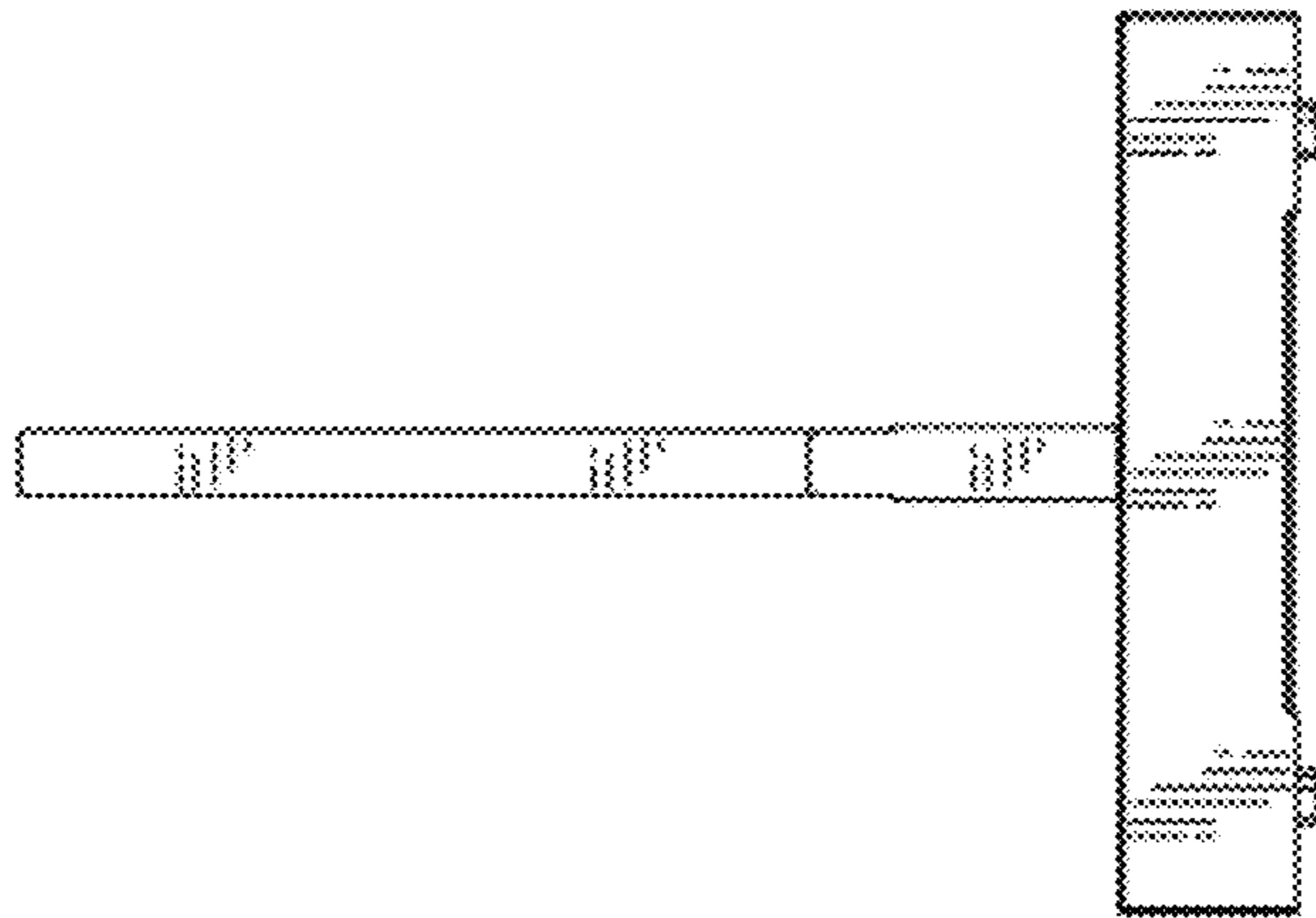

FIG. 4

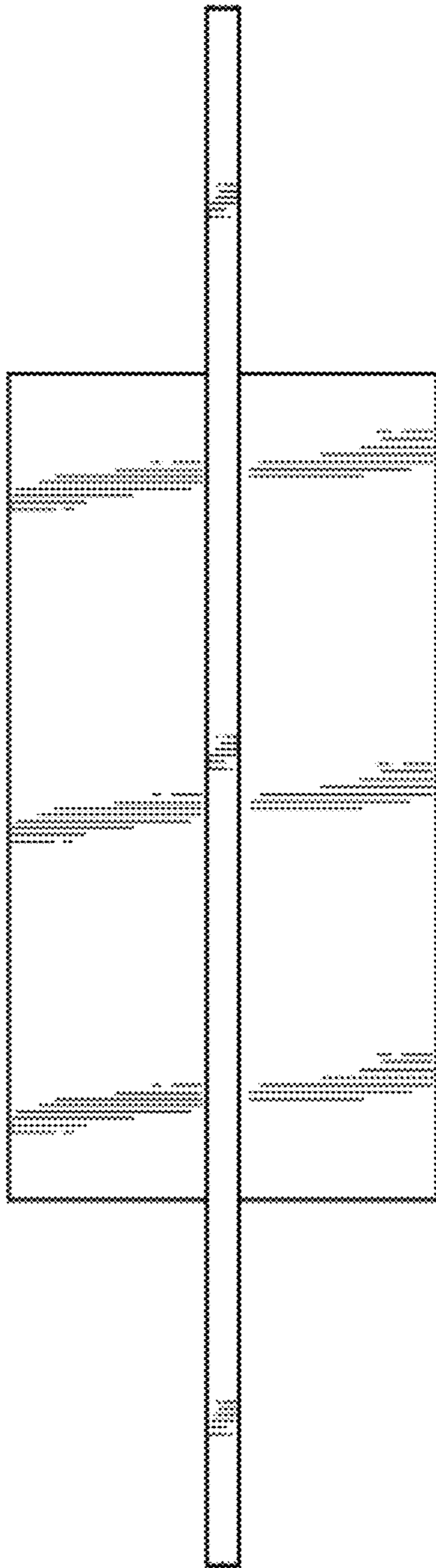

FIG. 6

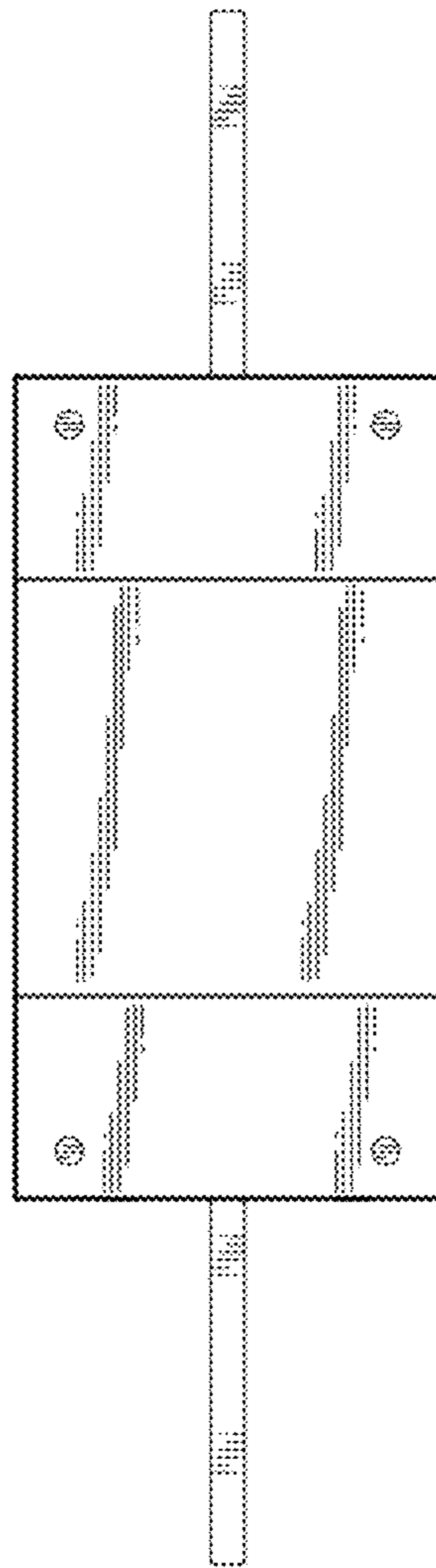

FIG. 7