



US00D830225S

(12) **United States Design Patent** (10) **Patent No.:** **US D830,225 S**
Suchla (45) **Date of Patent:** **** Oct. 9, 2018**

(54) **CHRISTMAS TREE ORNAMENT**

(71) Applicant: **Timothy A. Suchla**, Meridian, ID (US)

(72) Inventor: **Timothy A. Suchla**, Meridian, ID (US)

(**) Term: **15 Years**

(21) Appl. No.: **29/583,313**

(22) Filed: **Nov. 4, 2016**

(51) **LOC (11) Cl.** **11-05**

(52) **U.S. Cl.**
USPC **D11/124**

(58) **Field of Classification Search**

USPC D11/117, 121, 122, 123, 124, 125, 127,
D11/128, 131, 132, 133, 136, 157, 158,
D11/160; D99/25

CPC A47G 33/00; A47G 33/008; A47G 33/02;
A47G 33/08; A47G 33/0809; A47G
2033/0827

See application file for complete search history.

(56) **References Cited**

U.S. PATENT DOCUMENTS

2,000,060 A	5/1935	Brennan	
D112,578 S *	12/1938	McGuckin	D11/124
D122,501 S *	9/1940	Sargent	D11/136
D162,259 S *	2/1951	Sundeim	D11/124

(Continued)

Primary Examiner — Elizabeth J Oswecki

(74) *Attorney, Agent, or Firm* — Pedersen and Company, PLLC; Ken J. Pedersen; Barbara S. Pedersen

(57) **CLAIM**

The ornamental design for a Christmas tree ornament, as shown and described.

DESCRIPTION

FIG. 1 is a right, top perspective view of a first embodiment of a Christmas tree ornament showing my new design;

FIG. 2 is a front view of the Christmas tree ornament of FIG. 1;

FIG. 3 is a right side view of the Christmas tree ornament of FIG. 1;

FIG. 4 is a left side view of the Christmas tree ornament of FIG. 1;

FIG. 5 is a top view of the Christmas tree ornament of FIG. 1;

FIG. 6 is a bottom view of the Christmas tree ornament of FIG. 1;

FIG. 7 is a back view of the Christmas tree ornament of FIG. 1;

FIG. 8 is a cross sectional view taken along line 8-8 in FIG. 3;

FIG. 9 is a left side view of a second embodiment of a Christmas tree ornament showing my new design, the right side view is the same as FIG. 3, except for the lengthened bottom protrusions;

FIG. 10 is a back view of the Christmas tree ornament of FIG. 9, the front view is the same as FIG. 2, except for the lengthened bottom protrusion;

FIG. 11 is a bottom view of the Christmas tree ornament of FIG. 9, the top view is the same as FIG. 5;

FIG. 12 is the same cross sectional view shown in FIG. 8, except for the lengthened bottom protrusion;

FIG. 13 is a left side view of a third embodiment of a Christmas tree ornament showing my new design;

FIG. 14 is a rear view of the Christmas tree ornament of FIG. 13;

FIG. 15 is a right side view of the Christmas tree ornament of FIG. 13;

FIG. 16 is a top view of the Christmas tree ornament of FIG. 13;

FIG. 17 is a bottom view of the Christmas tree ornament of FIG. 13; and,

FIG. 18 is the same rear view as shown in FIG. 14, shown in a used condition with a tree shown in broken lines.

The broken lines in FIGS. 1-18 illustrate portions of the Christmas tree ornament that form no part of the claim.

1 Claim, 11 Drawing Sheets

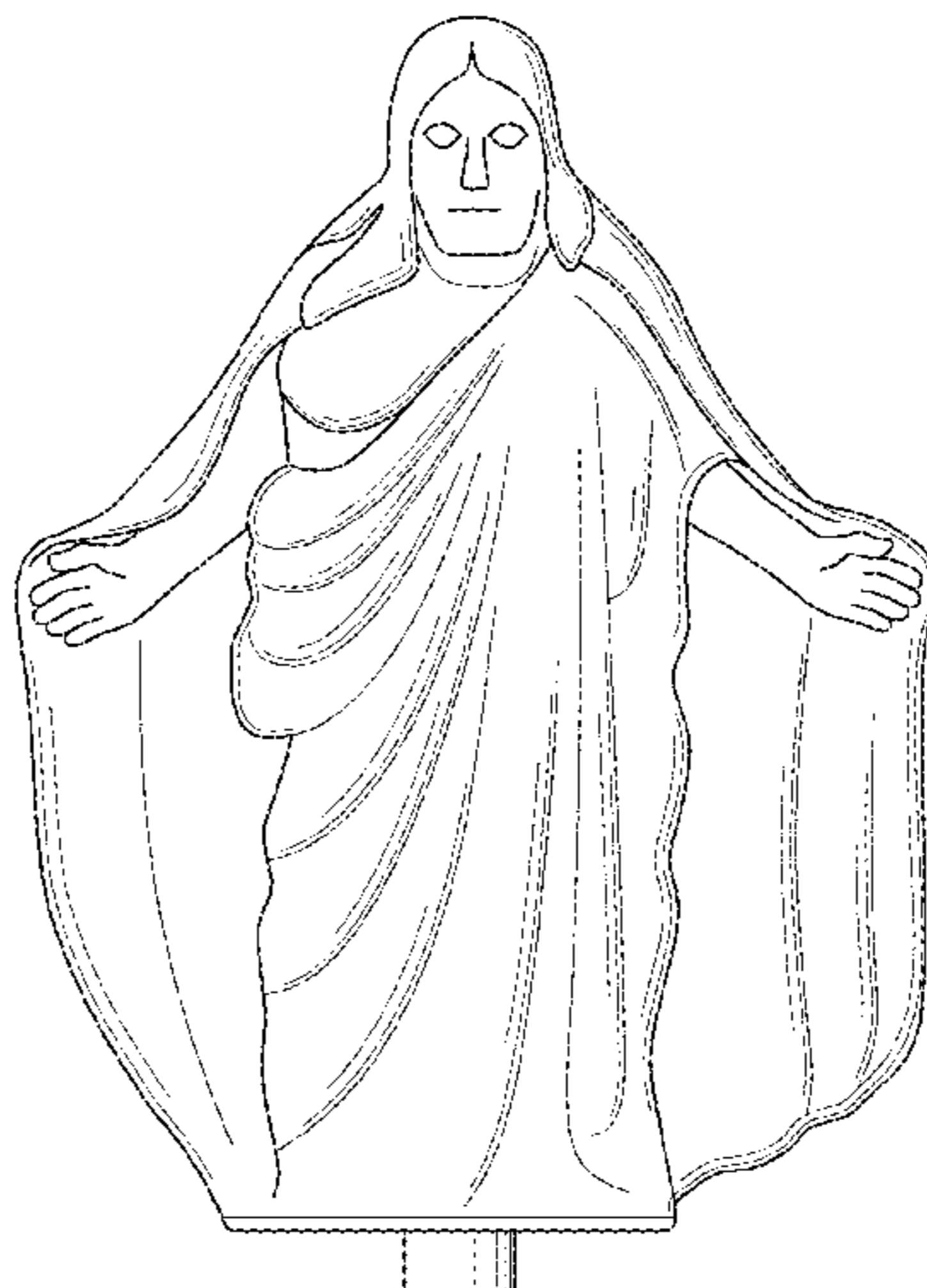

(56)

References Cited

U.S. PATENT DOCUMENTS

D181,262	S	10/1957	Abramson	
D185,274	S	5/1959	Flaster	
D341,331	S *	11/1993	Richards, Jr.	D10/106.4
5,456,625	A	10/1995	Dumond	
D378,202	S *	2/1997	Scott	D11/124
D381,184	S	7/1997	Monahan	
D390,321	S	2/1998	Maple et al.	
D405,131	S	2/1999	Nelson	
D405,707	S *	2/1999	Smyth	D10/106.4
D405,722	S *	2/1999	Ayoub	D11/124
D439,543	S *	3/2001	Branaman	D11/124
D449,249	S *	10/2001	Zadok	D11/162
D462,292	S	9/2002	Hanlon et al.	
6,539,655	B1	4/2003	Earle	
D476,260	S	6/2003	Ross	
D476,790	S	7/2003	Ruiz	
D492,615	S	7/2004	Sonntag	
D518,531	S	4/2006	Vigliano	
7,370,394	B1 *	5/2008	Juneau	A01N 1/00 27/1
D572,624	S *	7/2008	Garrison	D11/121
D591,198	S	4/2009	Valera et al.	
D601,447	S	10/2009	Rudy et al.	
8,151,420	B2 *	4/2012	Randall	E04H 13/001 27/1
D688,974	S	9/2013	Thiel	
D714,014	S	9/2014	Miles	
D738,967	S *	9/2015	McBride	D21/626
D757,211	S	5/2016	Slocum	

* cited by examiner



FIG. 1

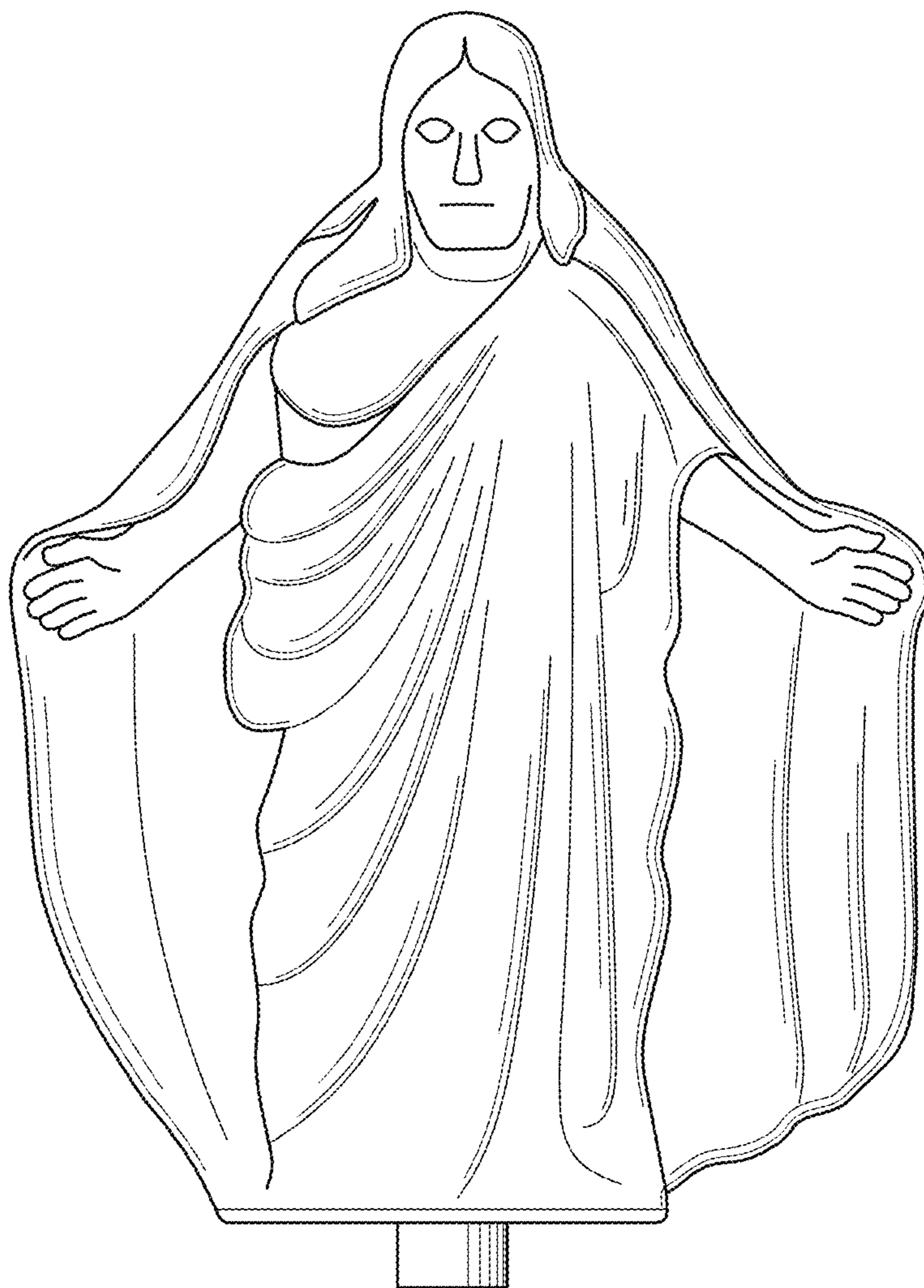

FIG. 2

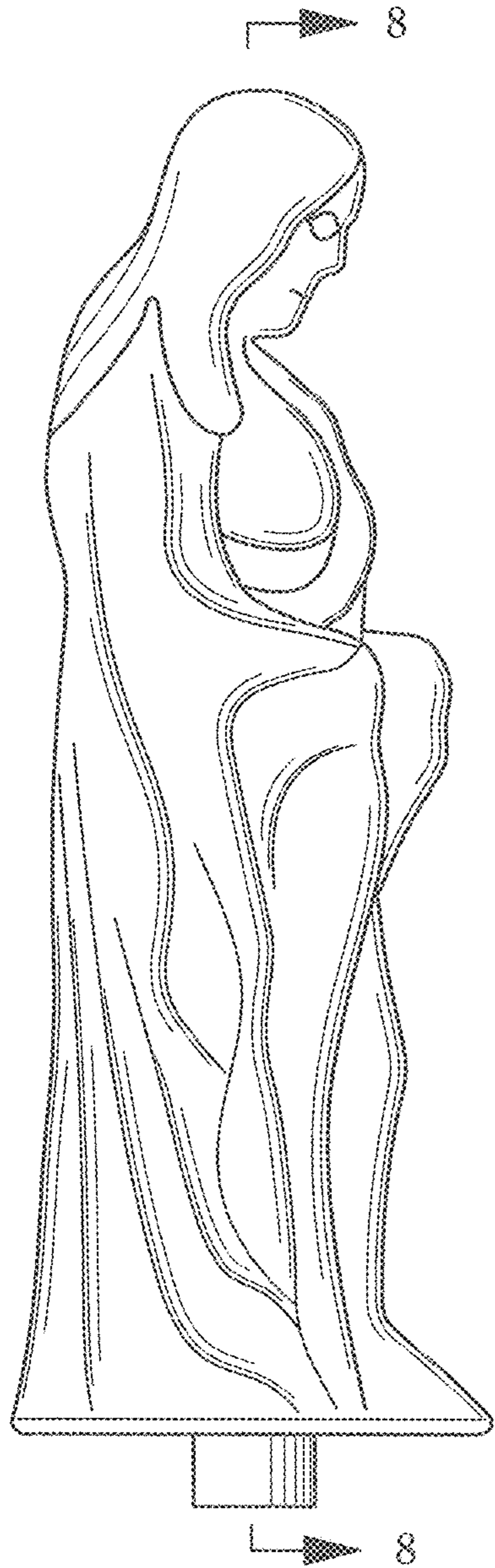

FIG. 3

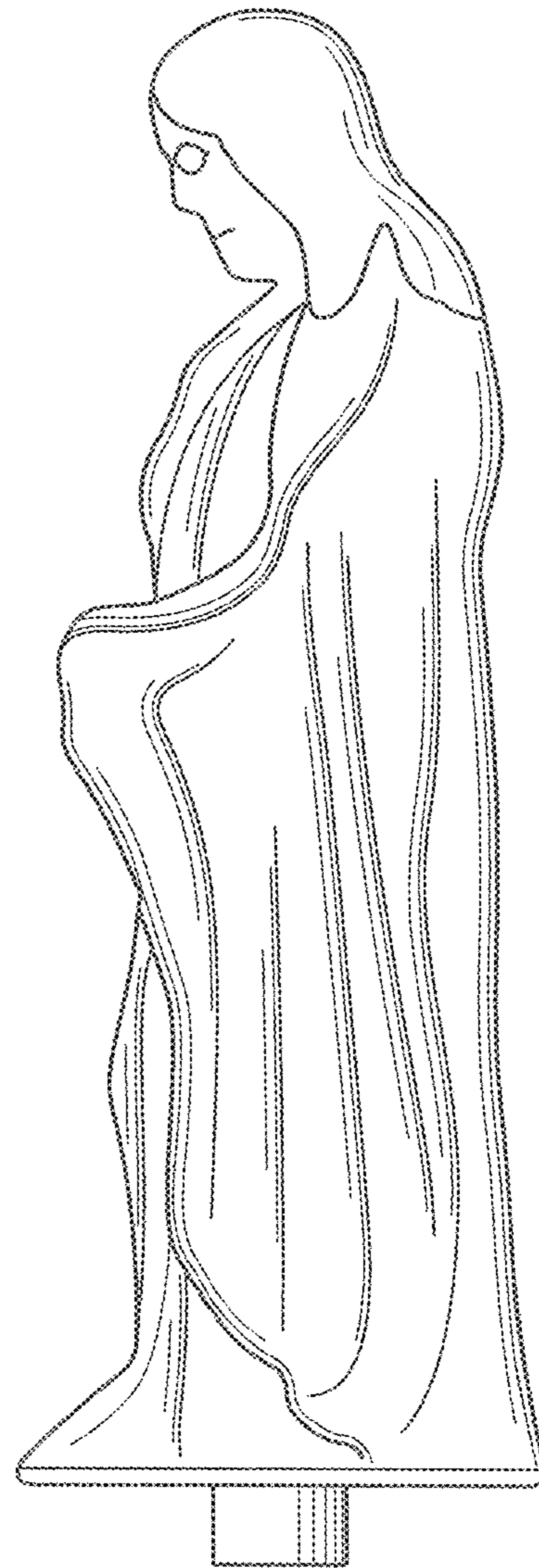

FIG. 4

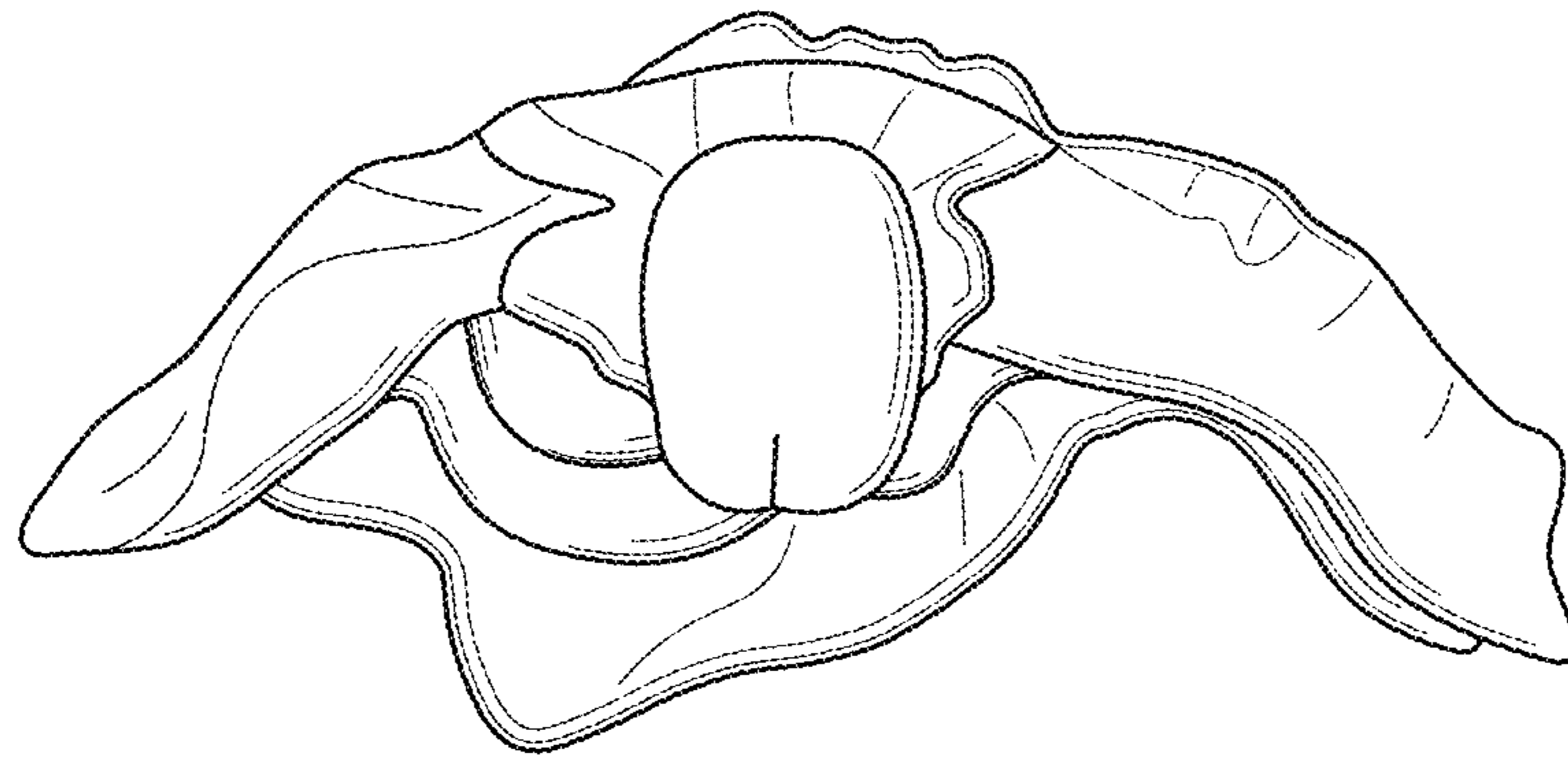

FIG. 5

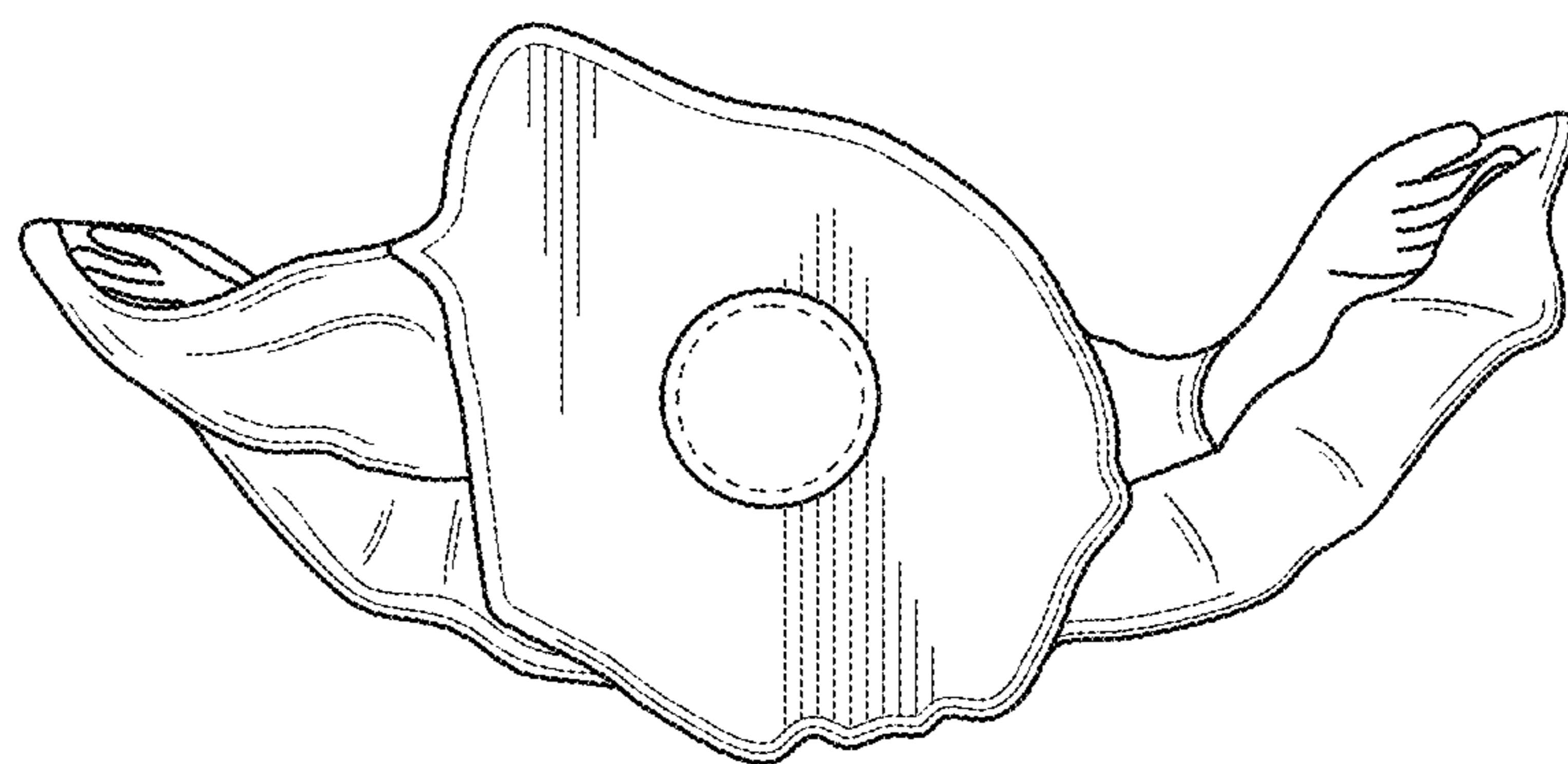

FIG. 6



FIG. 7

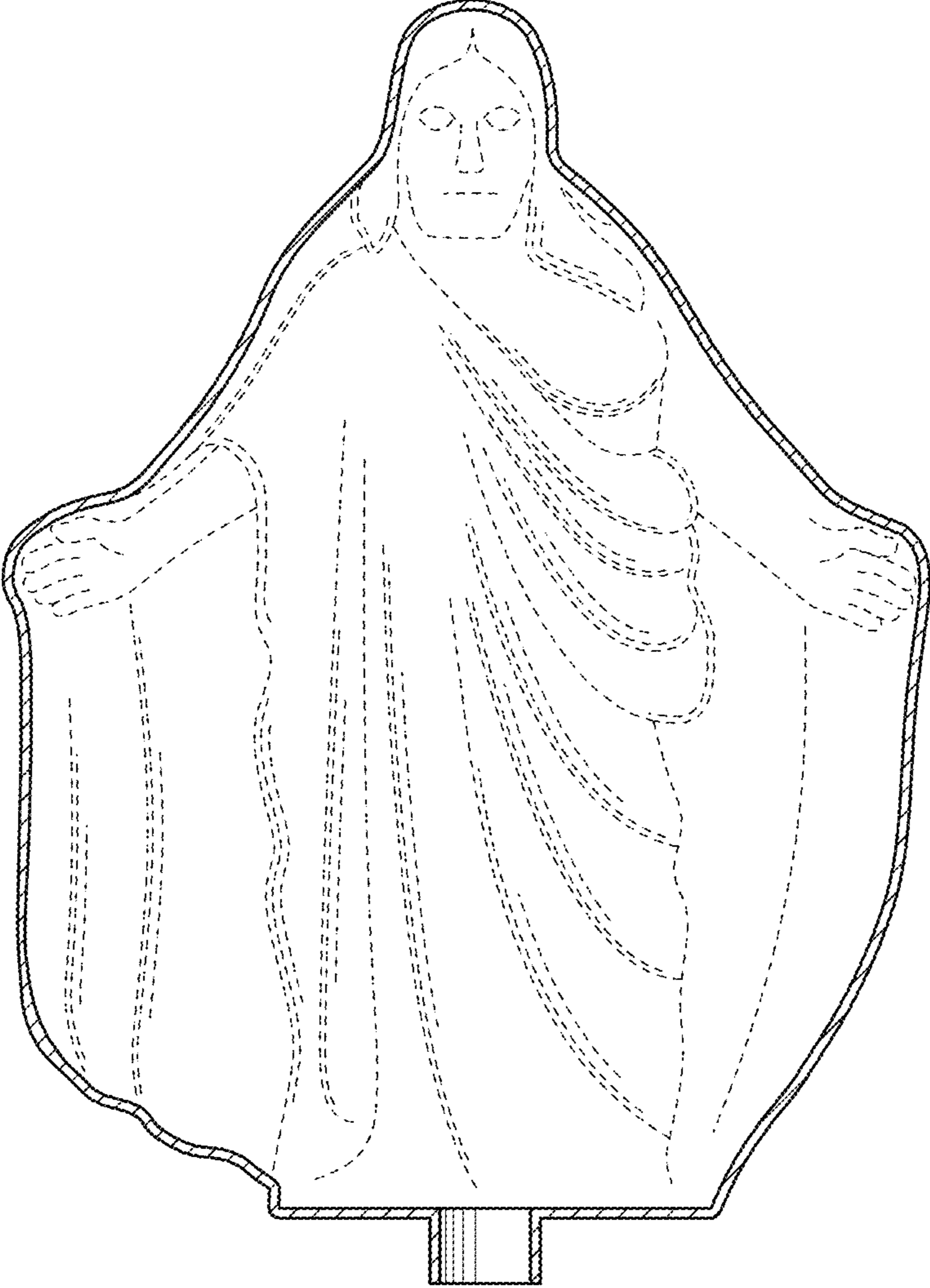

FIG. 8

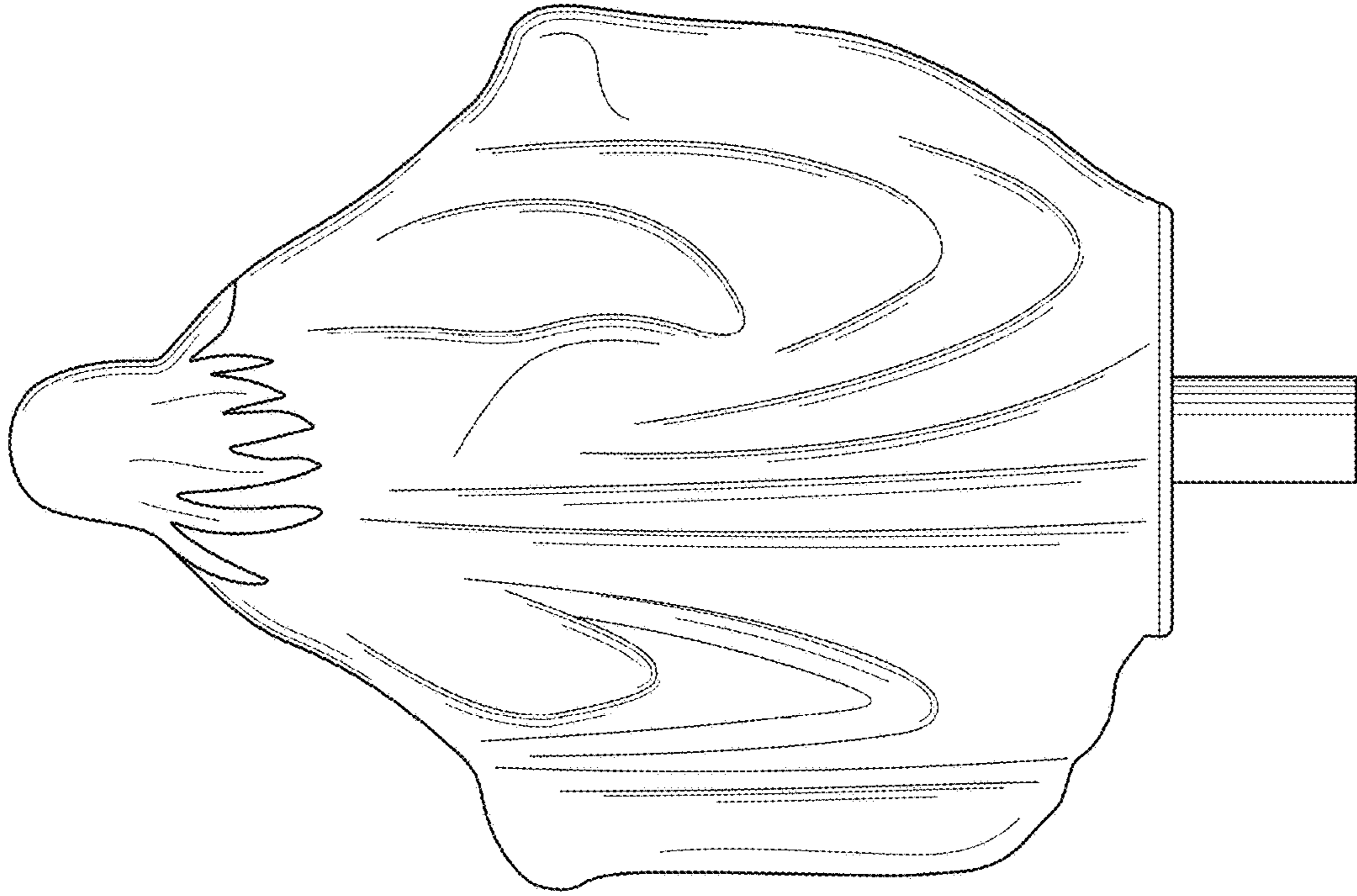

FIG. 10

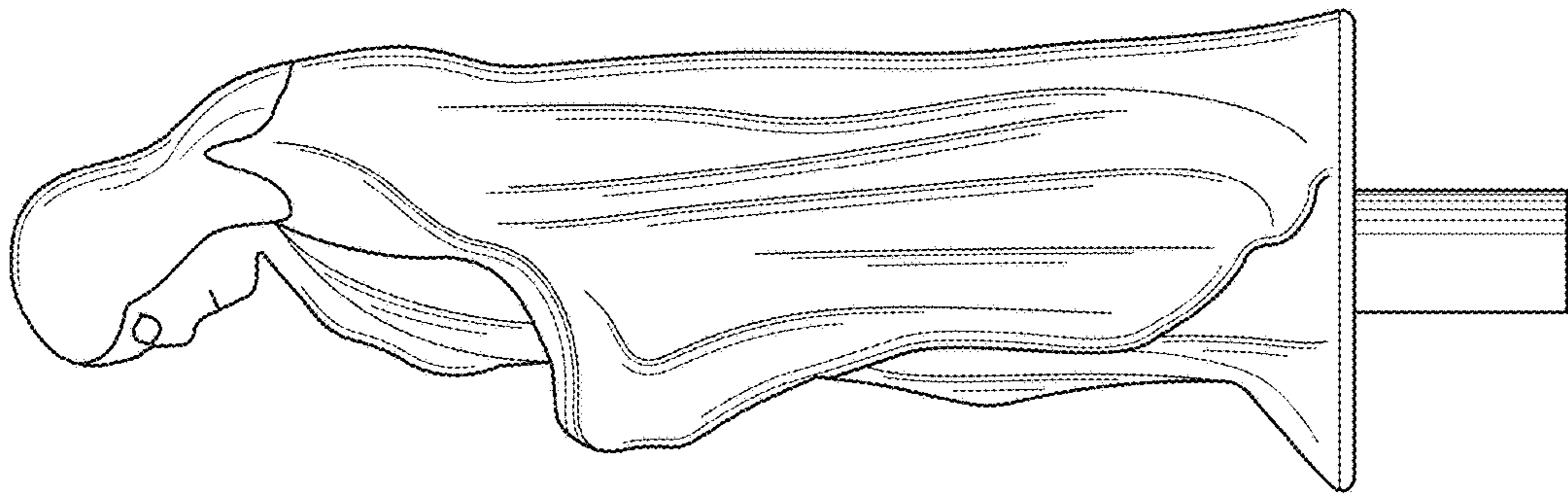

FIG. 9

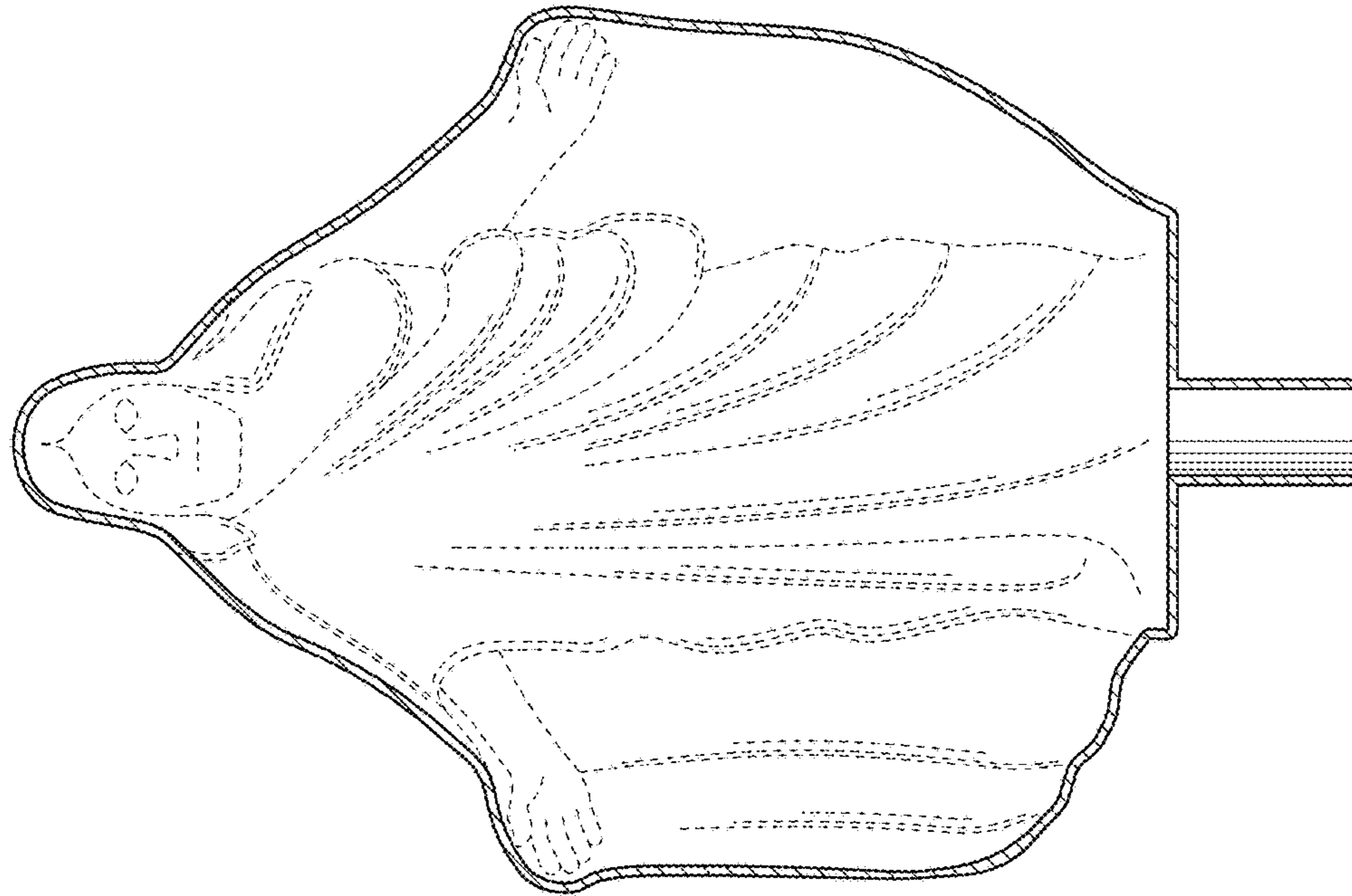

FIG. 12

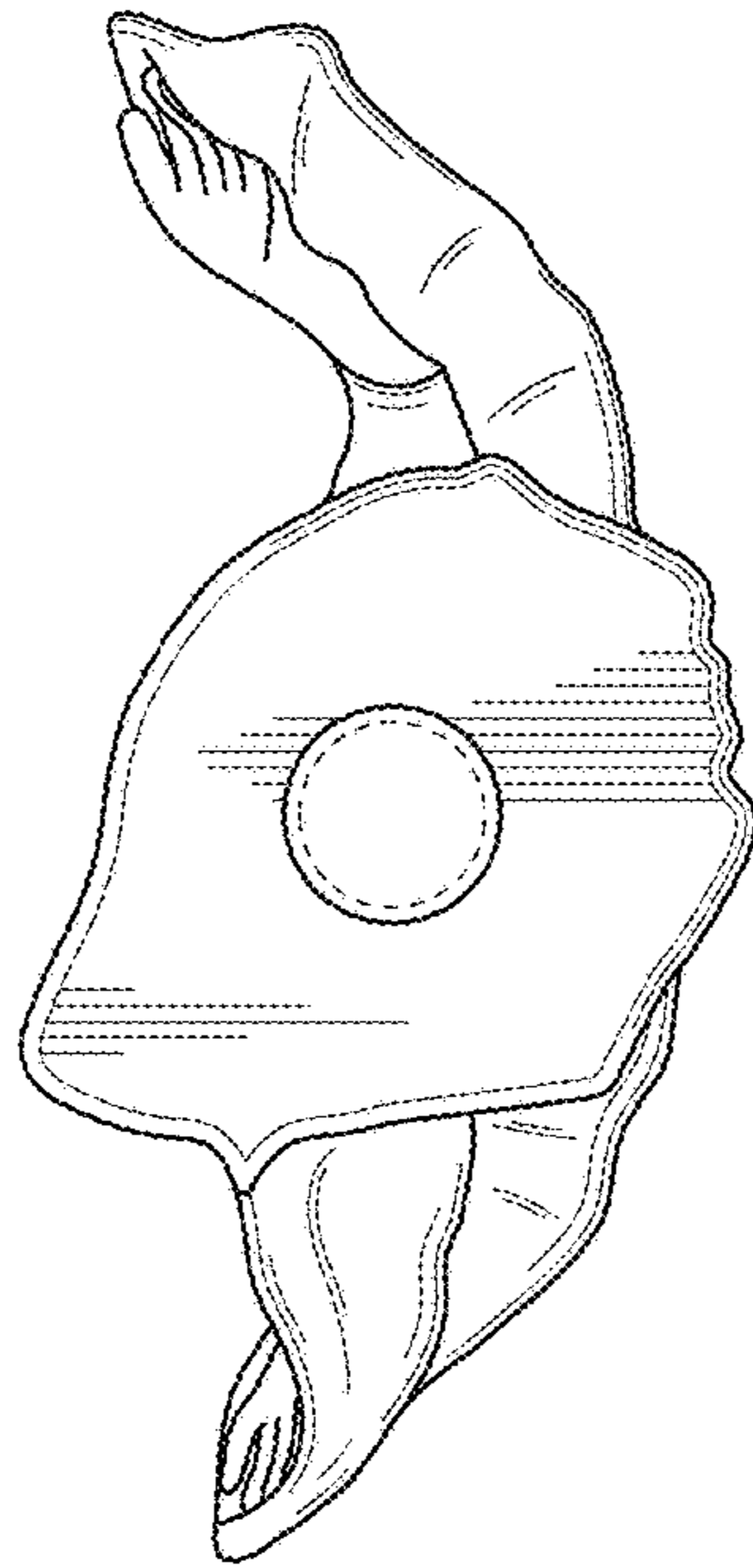

FIG. 11

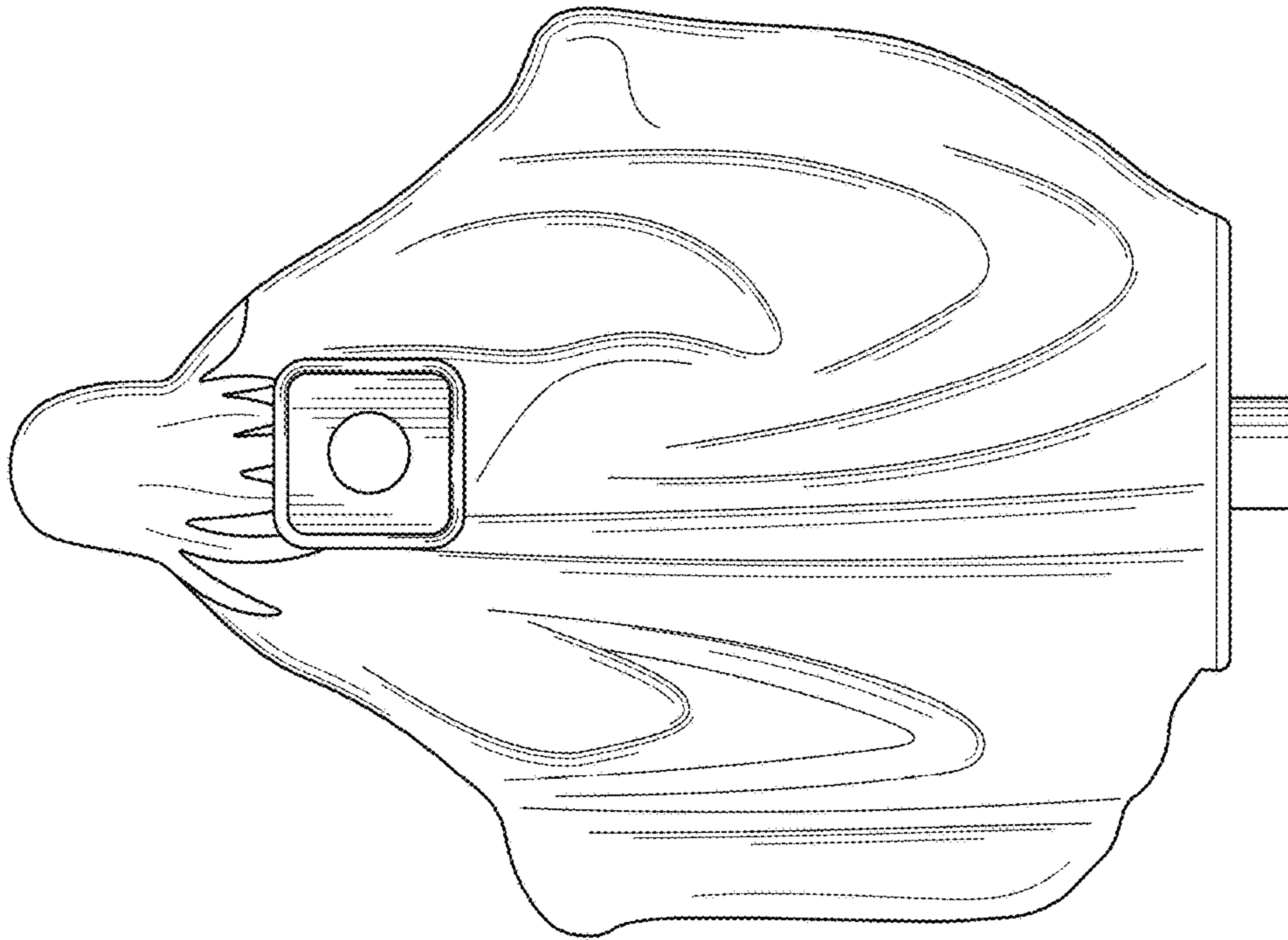

FIG. 14

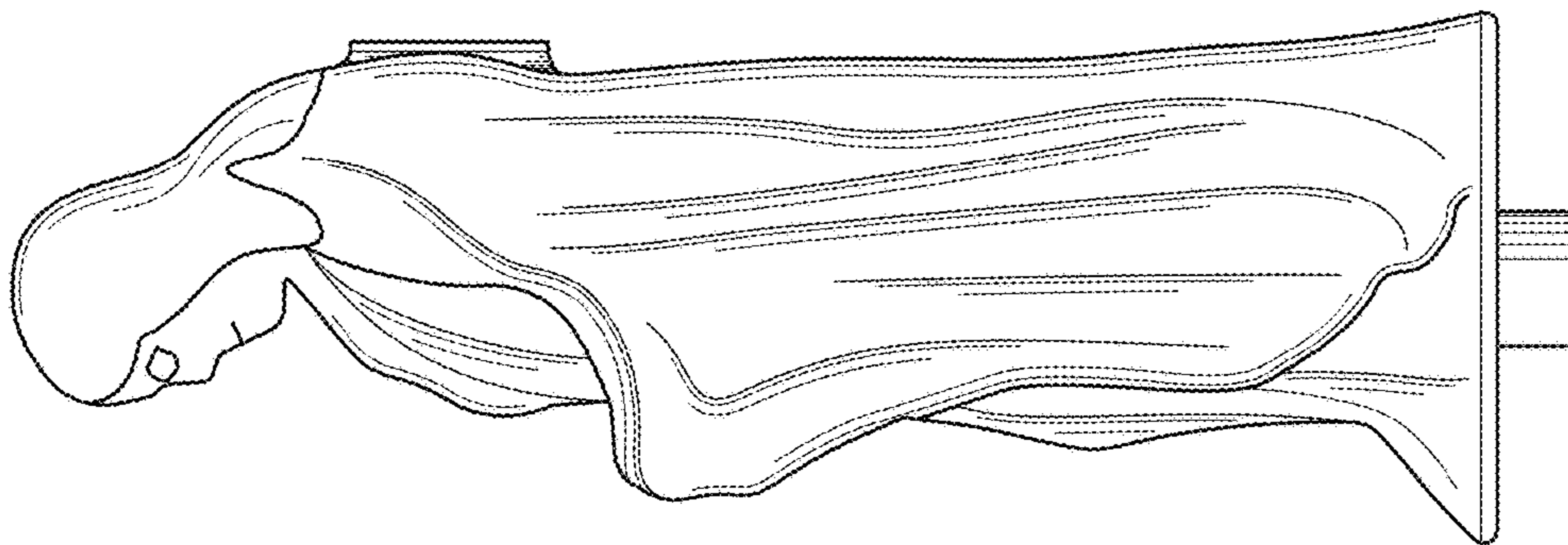

FIG. 13

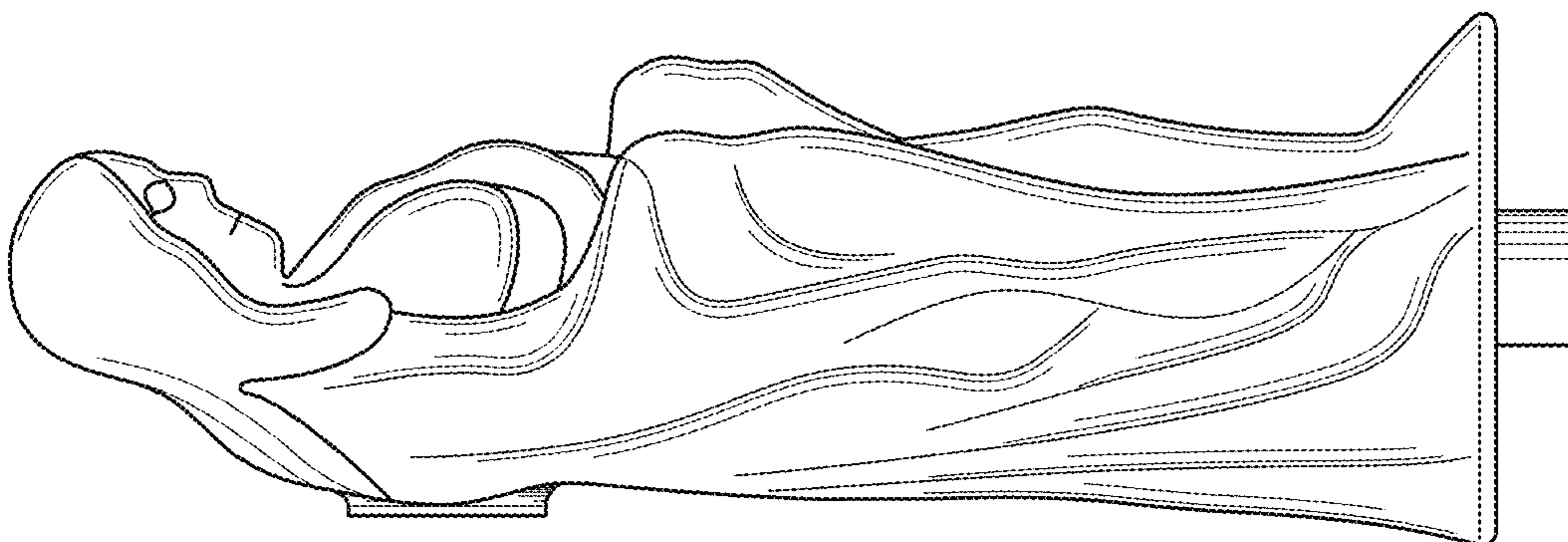

FIG. 15

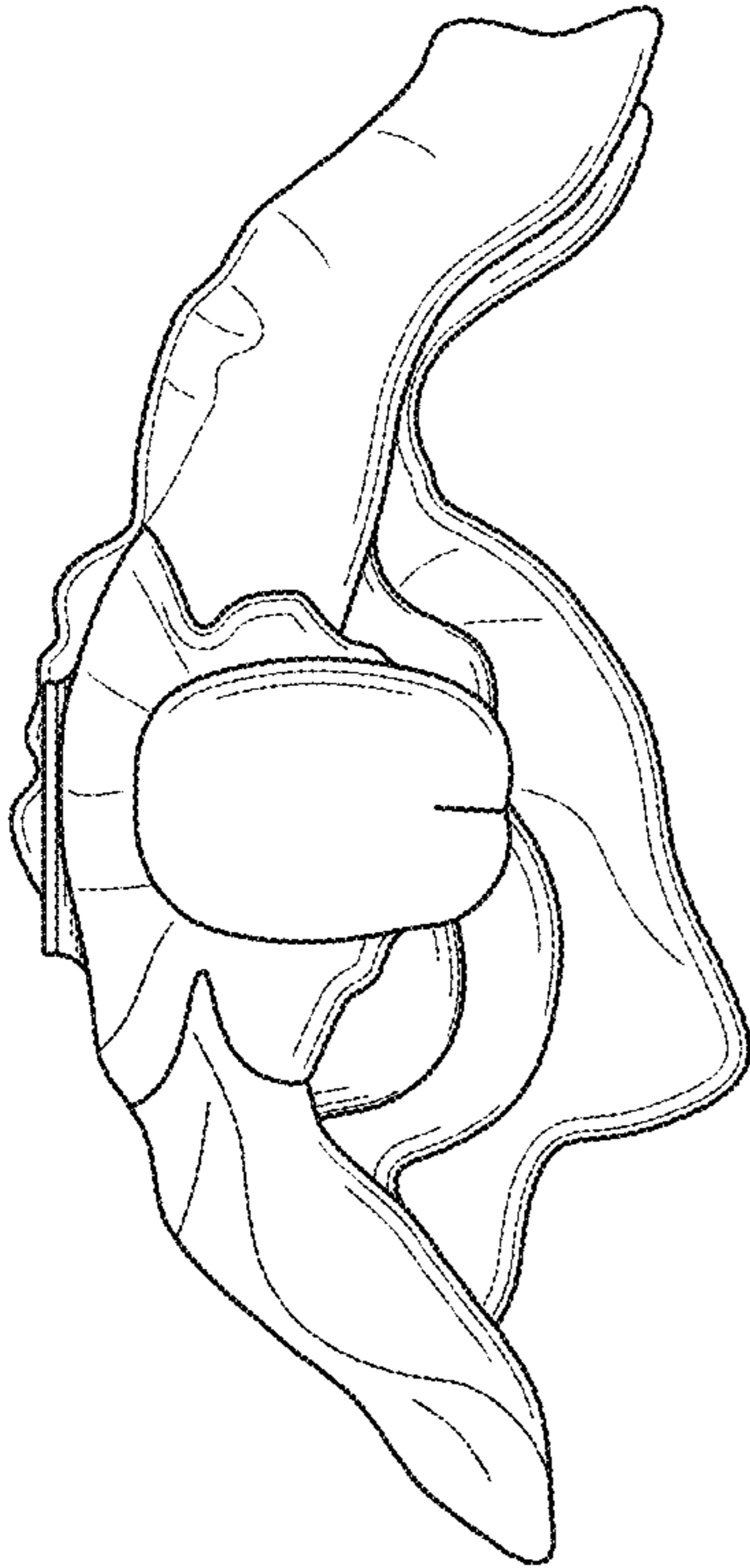

FIG. 16

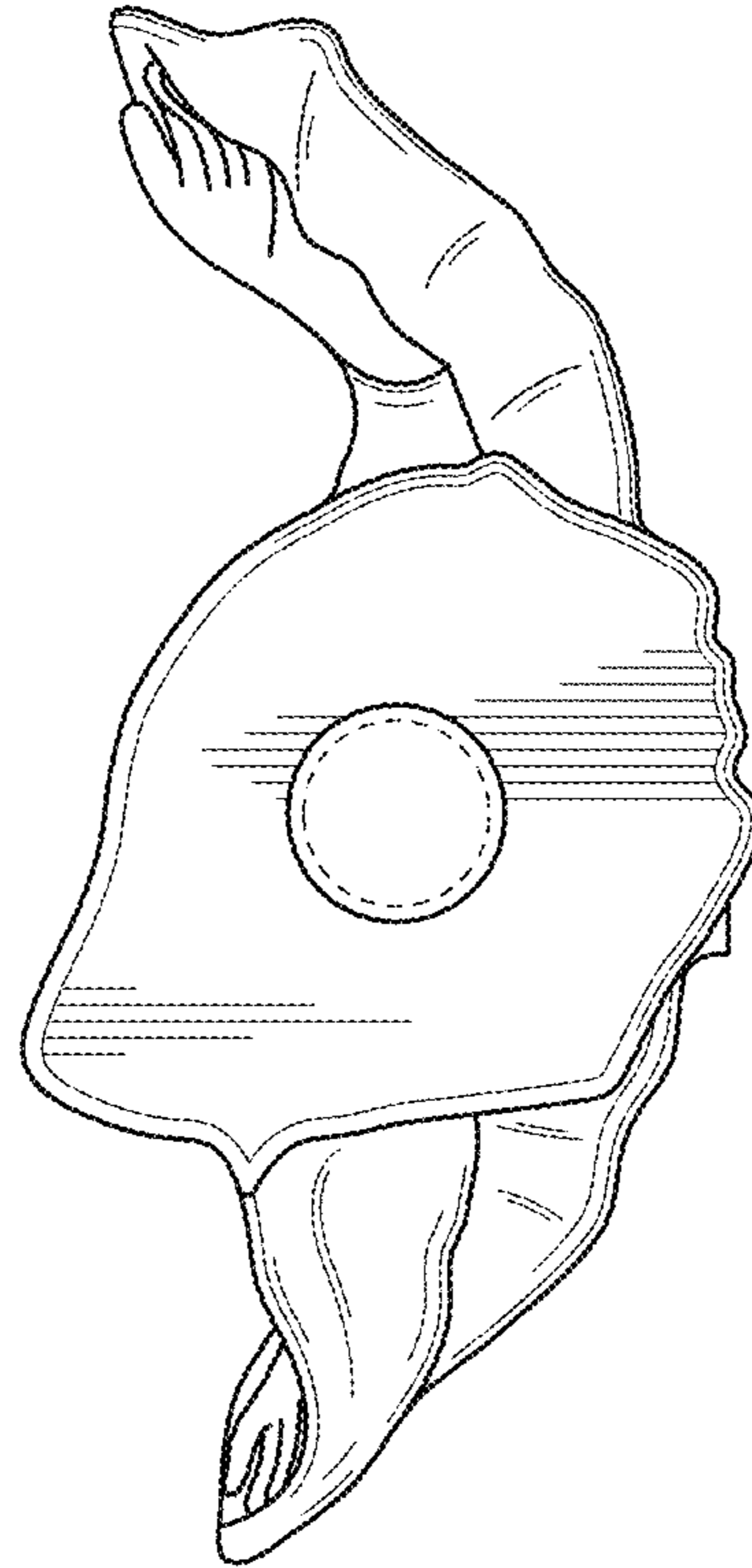

FIG. 17

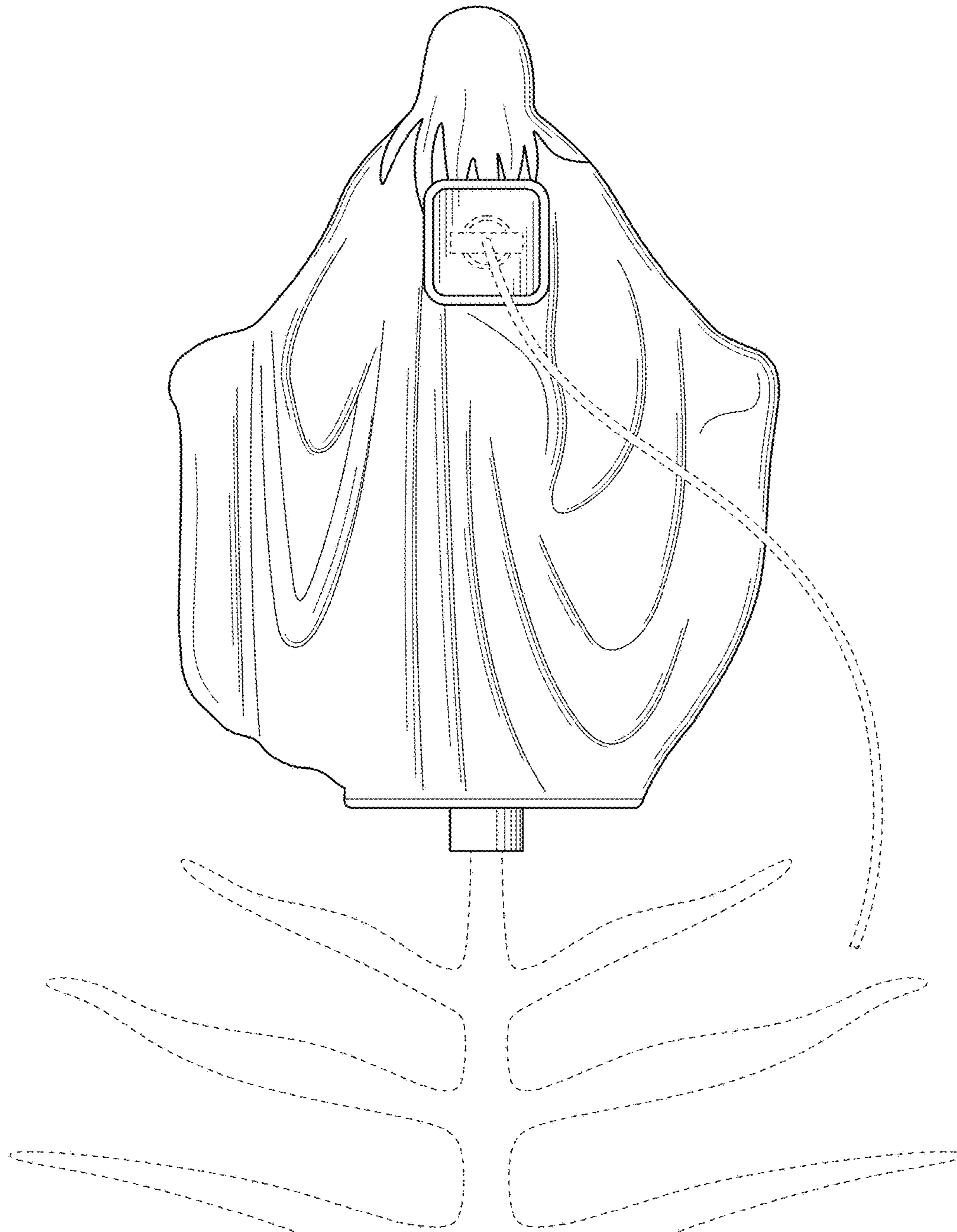

FIG. 18