



US00D830173S

(12) **United States Design Patent** (10) **Patent No.:** **US D830,173 S**  
**Holmes** (45) **Date of Patent:** **\*\* Oct. 9, 2018**

(54) **CLOSURE** 1,981,414 A \* 11/1934 Hermani ..... B65D 41/0492  
215/334  
(71) Applicant: **Closure Systems International Inc.,** D154,204 S \* 6/1949 Jung ..... D9/453  
Lake Forest, IL (US) D198,953 S \* 8/1964 Quintal ..... D19/194  
D200,819 S \* 4/1965 Perun ..... D9/434  
(72) Inventor: **Larry Holmes, Fishers, IN (US)** 3,204,801 A \* 9/1965 Switzgable, Jr. .... B65D 45/32  
215/274  
(73) Assignee: **Closure Systems International Inc.,** D252,208 S \* 6/1979 Ooya ..... D16/219  
Lake Forest, IL (US) 4,290,466 A \* 9/1981 Villa ..... B65D 75/5872  
206/216  
(\*\*) Term: **15 Years** D273,942 S \* 5/1984 Brueck ..... D9/434  
D276,872 S \* 12/1984 Williams ..... D28/91  
(Continued)

(21) Appl. No.: **29/594,657**

(22) Filed: **Feb. 21, 2017**

(51) **LOC (11) Cl.** ..... **09-07**

(52) **U.S. Cl.**  
USPC ..... **D9/443; D9/452**

(58) **Field of Classification Search**  
USPC ..... D9/414, 415, 424, 425, 434, 435, 436,  
D9/443, 444-452, 454-456, 499, 529,  
D9/682, 685, 686; D7/387, 391, 392,  
D7/392.1, 396.1, 396.2, 396.3, 396.4,  
D7/397, 398, 401.1, 507, 509-511, 538,  
D7/900; D3/202, 203.2; D28/91, 91.1;  
D12/197; D23/249, 260  
CPC .. A61J 1/00; A61J 1/1412; B65D 1/00; B65D  
1/02; B65D 1/10; B65D 1/46; B65D  
2585/56; B65D 2585/545; B65D 41/00;  
B65D 41/38; B65D 41/56; B65D 41/62;  
B65D 47/00; B65D 47/06; B65D 47/08;  
B65D 2543/00046; B65D 2543/00092;  
B65D 2543/00296; B65D 5/46; B65D  
2251/00

See application file for complete search history.

(56) **References Cited**

**U.S. PATENT DOCUMENTS**

D18,622 S \* 9/1888 Curtice ..... D9/452  
1,848,773 A \* 3/1932 Fison ..... B65D 45/32  
215/274

*Primary Examiner* — Michael A. Pratt  
*Assistant Examiner* — Wendy L Arminio  
(74) *Attorney, Agent, or Firm* — Nixon Peabody LLP

(57) **CLAIM**

The ornamental design for a closure, as shown and described.

**DESCRIPTION**

FIG. 1 is a top-perspective view of a closure;  
FIG. 2 is a side cross-sectional view taken in the direction of line 2-2 shown in FIG. 1;  
FIG. 3 is a bottom-perspective view of the closure of FIG. 1;  
FIG. 4 is a top plan view of the closure of FIG. 1;  
FIG. 5 is a left side elevation view of the closure of FIG. 1;  
FIG. 6 is a right side elevation view of the closure of FIG. 1;  
FIG. 7 is a front elevation view of the closure of FIG. 1;  
FIG. 8 is a back elevation view of the closure of FIG. 1; and,  
FIG. 9 is a bottom plan view of the closure of FIG. 1.  
The dash-dash broken lines in the drawings depict environmental structure and form no part of the claimed design. The dash-dot-dash broken lines depict the boundaries of the claim and form no part thereof.

**1 Claim, 4 Drawing Sheets**

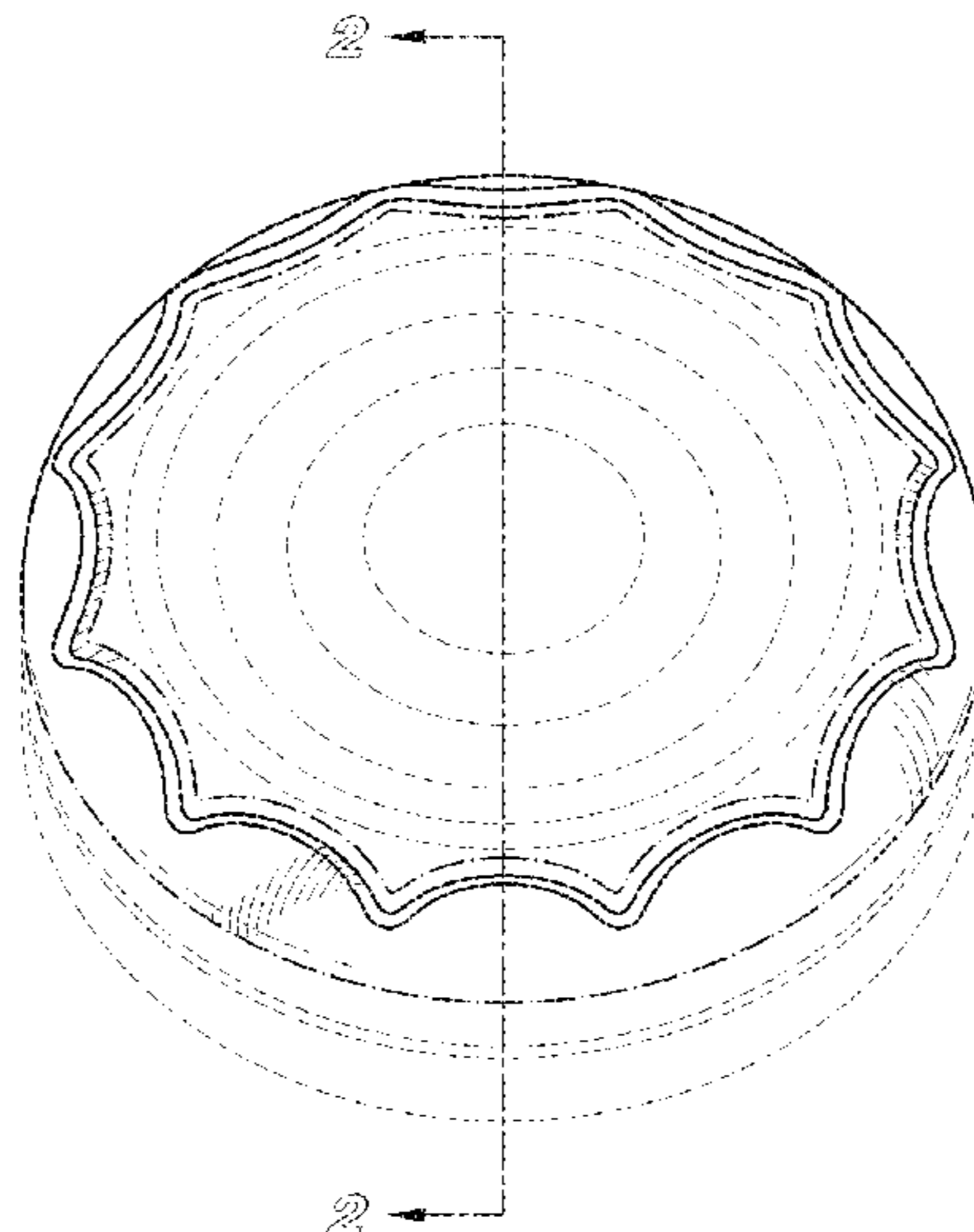

(56)

## References Cited

## U.S. PATENT DOCUMENTS

D294,680 S \* 3/1988 Pappert ..... D9/435  
D353,357 S \* 12/1994 Weinberg ..... D12/197  
D354,914 S \* 1/1995 Newman ..... D9/453  
D397,320 S \* 8/1998 Hoagland, IV ..... D12/197  
6,047,710 A \* 4/2000 Irving ..... A45C 13/008  
132/293  
D433,329 S \* 11/2000 Hampshire ..... D9/414  
D458,540 S \* 6/2002 Clements ..... D9/516  
D467,803 S \* 12/2002 Brown ..... D9/435  
D478,780 S \* 8/2003 Lugo ..... D7/566  
D529,804 S \* 10/2006 Lohrman ..... D9/453  
D534,796 S \* 1/2007 Falkenburg ..... D23/262  
D544,425 S \* 6/2007 Hutchison ..... D12/197  
D560,095 S \* 1/2008 Bodum ..... D7/387  
D566,640 S \* 4/2008 Holz ..... D12/197  
D622,124 S \* 8/2010 Kegg ..... D8/83  
8,087,528 B1 \* 1/2012 Scarlett ..... A47G 23/0216  
220/23.89  
D662,869 S \* 7/2012 Ballard ..... D12/213  
D673,005 S \* 12/2012 Lion ..... D7/354  
D681,459 S \* 5/2013 Ramsey ..... D9/452  
D684,455 S \* 6/2013 Relyea ..... D8/397  
D698,260 S \* 1/2014 Phelps ..... D9/682  
D710,699 S \* 8/2014 Phelps ..... D9/452  
D755,633 S \* 5/2016 Baughman ..... D9/452  
D756,280 S \* 5/2016 Davito ..... D12/197  
D759,342 S \* 6/2016 Clements ..... D1/122  
D760,345 S \* 6/2016 Campbell ..... D23/206  
D784,240 S \* 4/2017 Platto ..... D12/213  
2015/0129600 A1 \* 5/2015 Akers ..... B44D 3/127  
220/700

\* cited by examiner

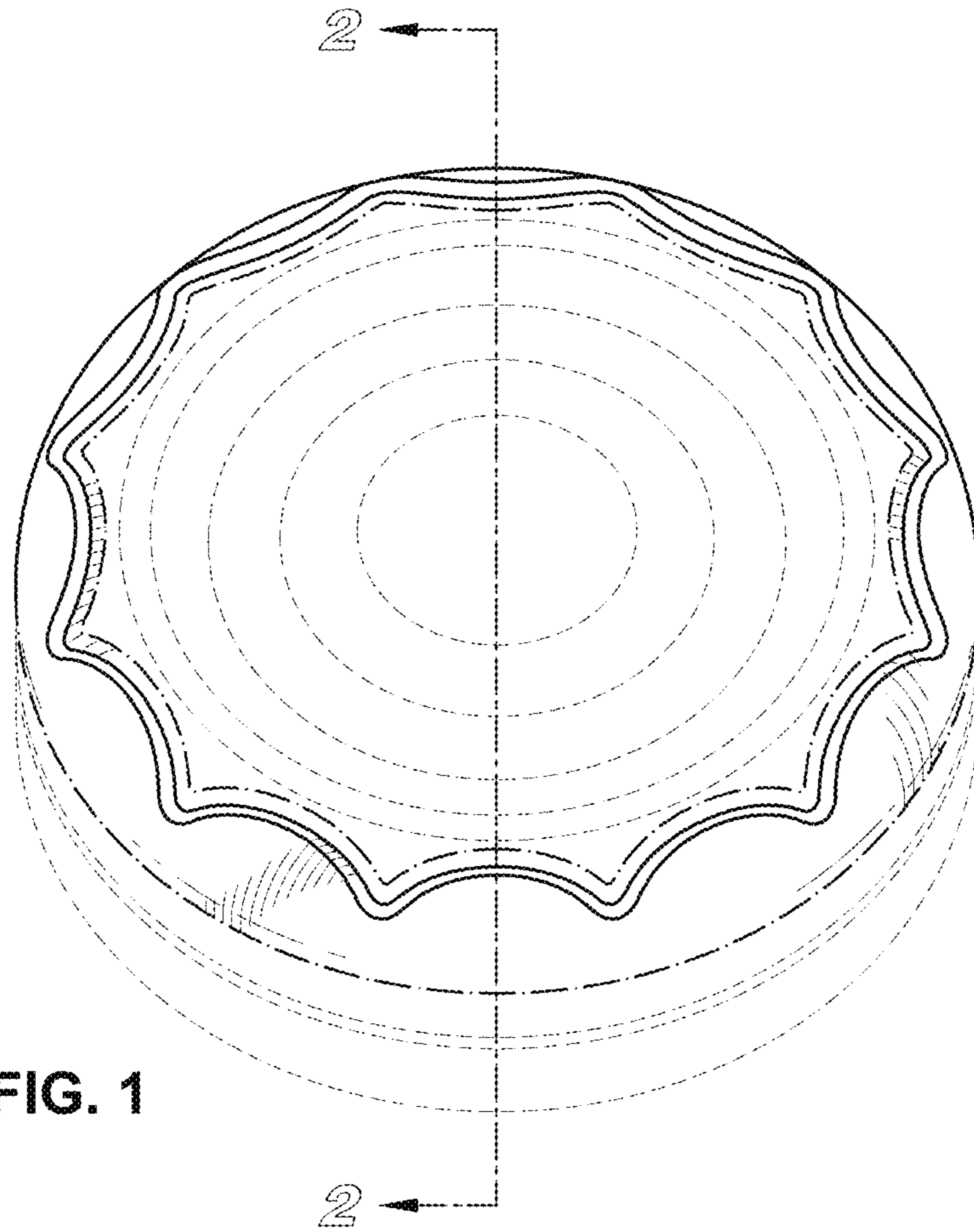

FIG. 1

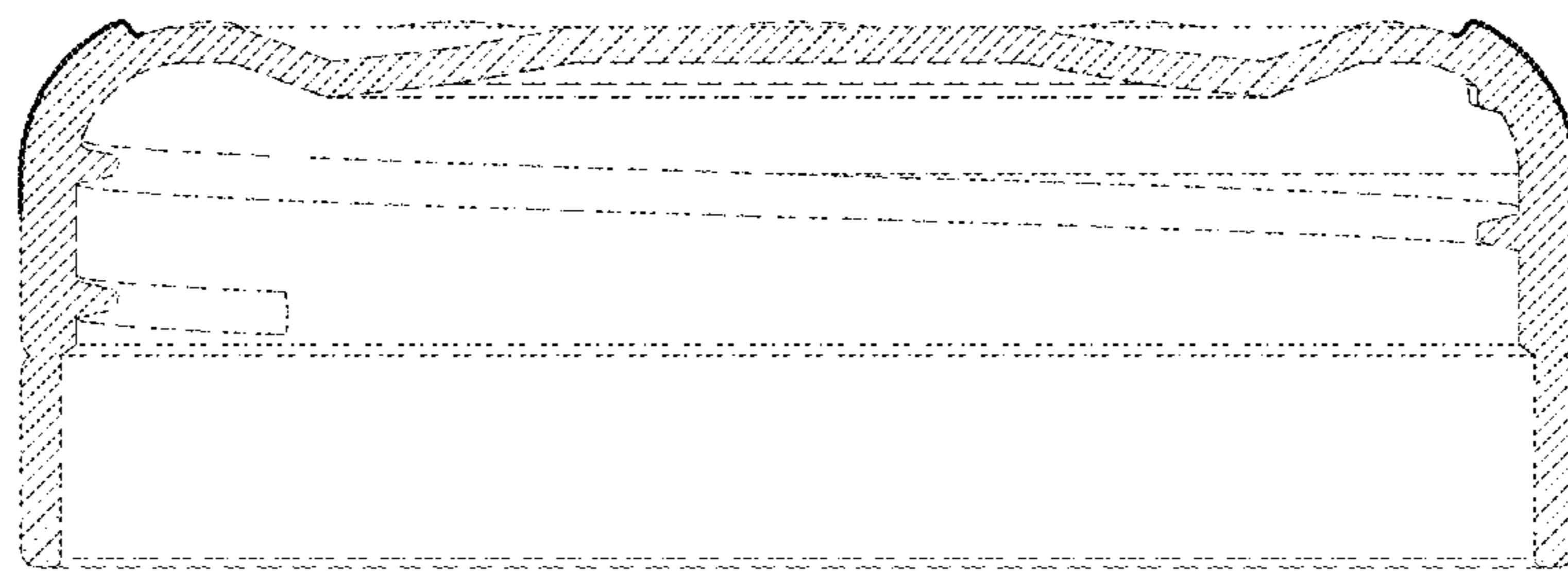
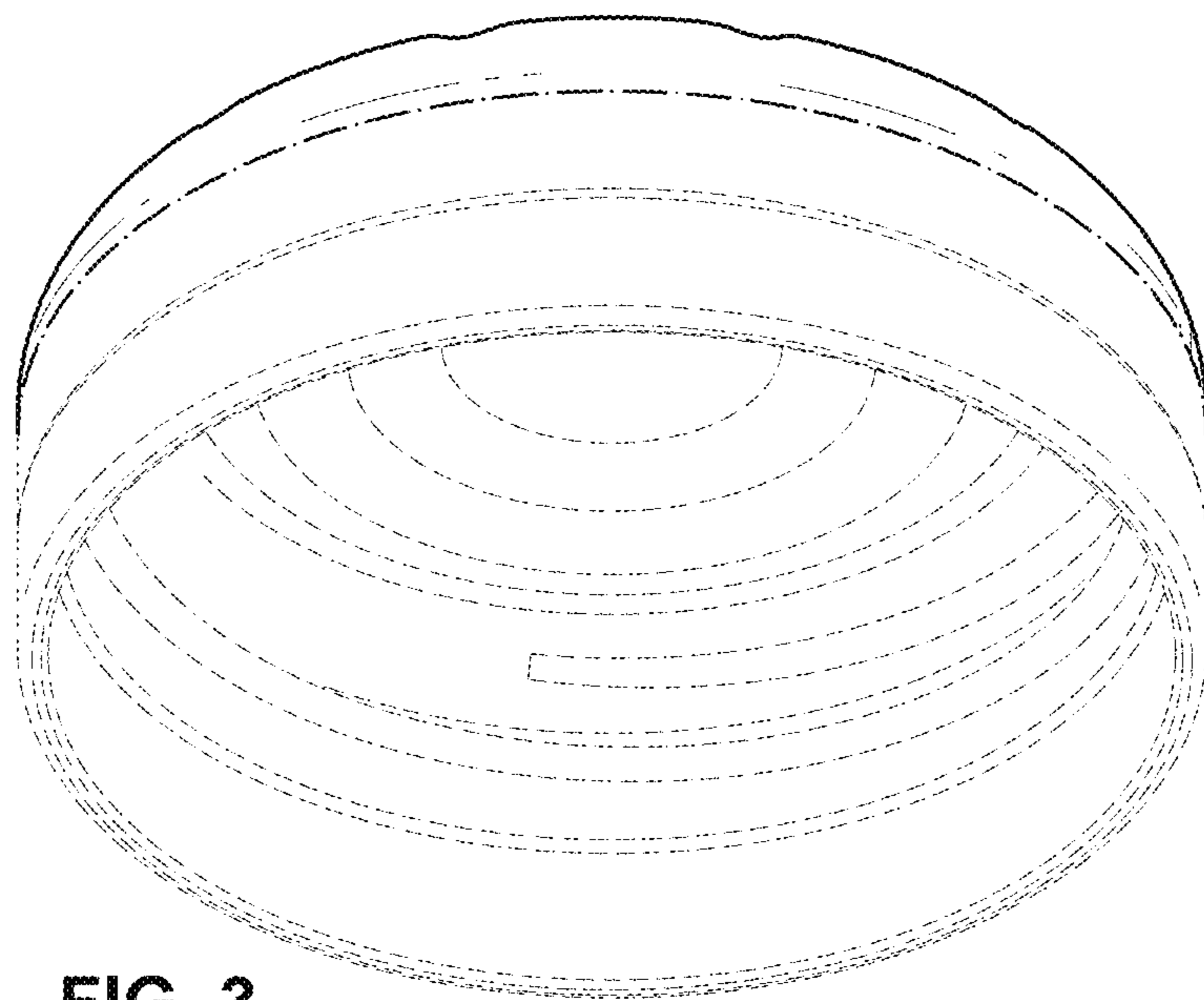

FIG. 2



**FIG. 3**

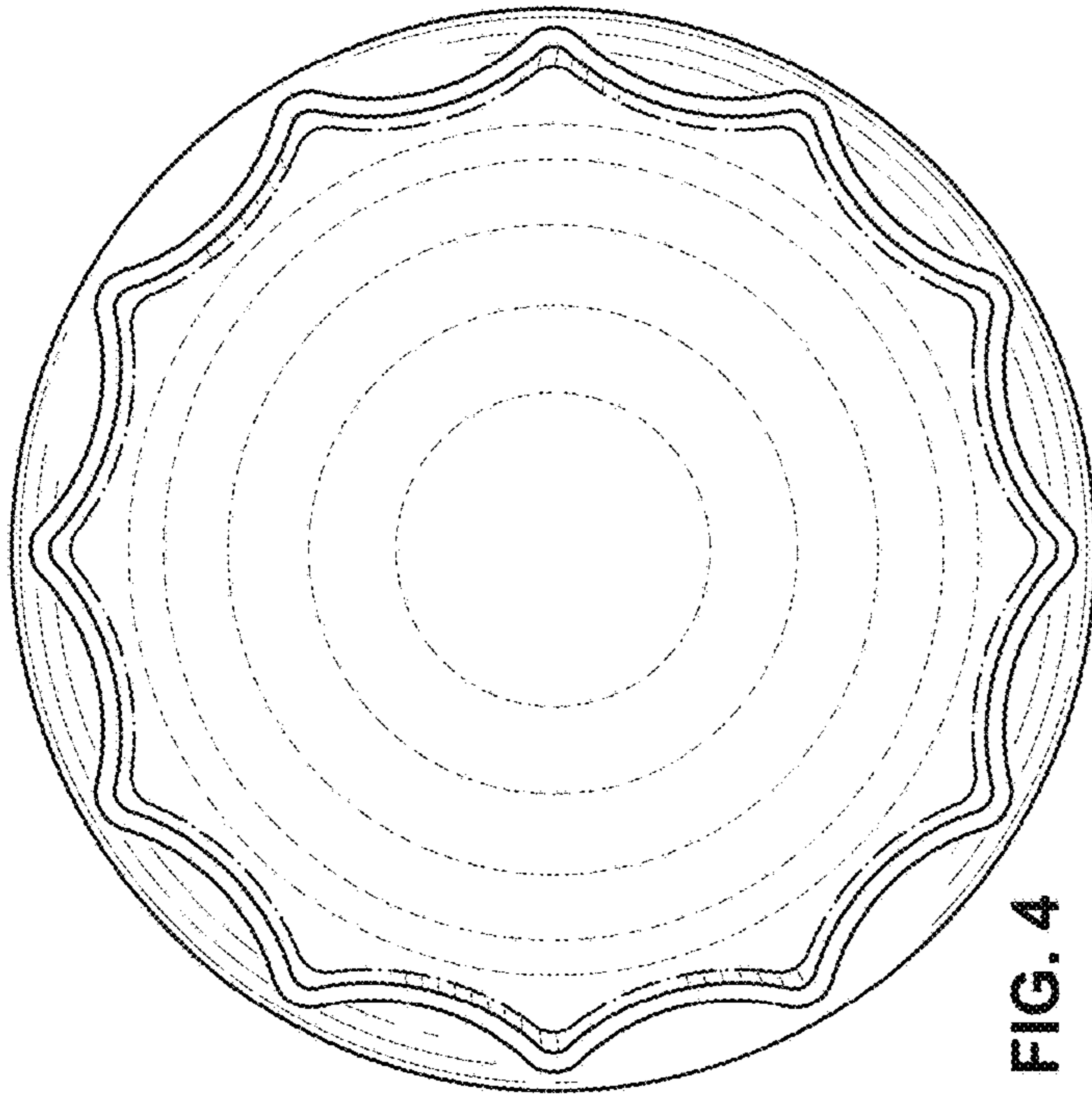

FIG. 4

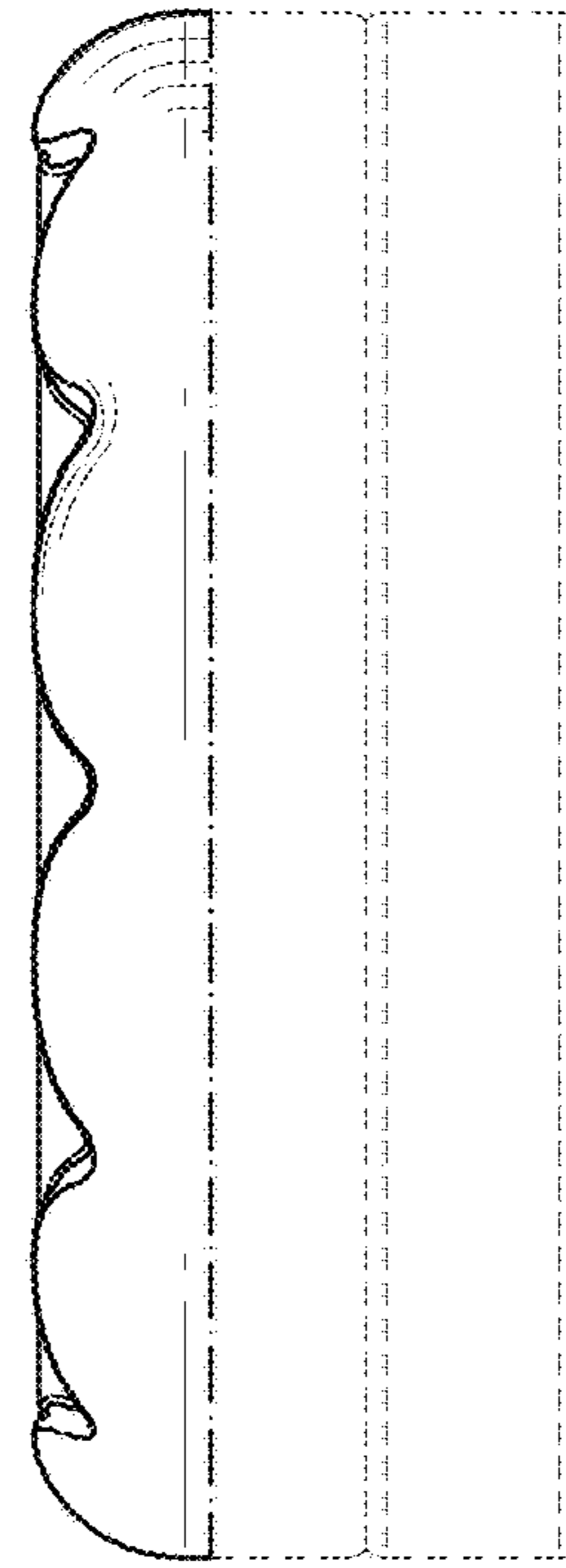

FIG. 6

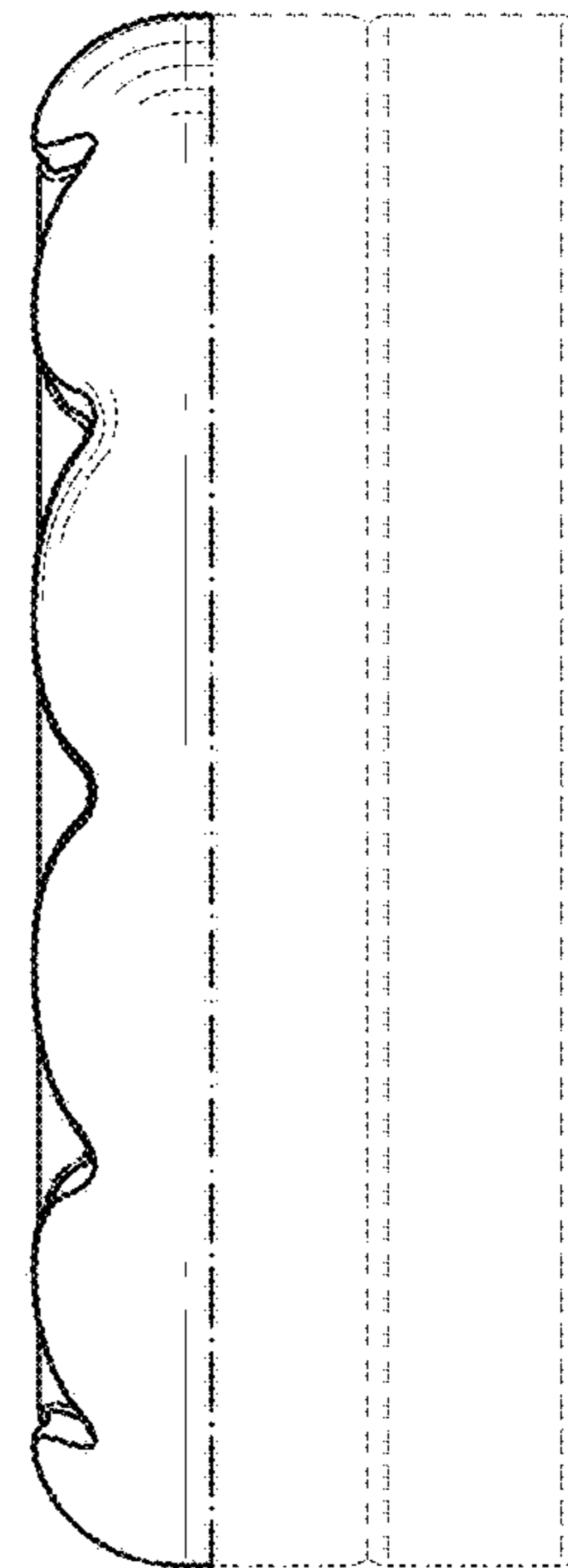

FIG. 5

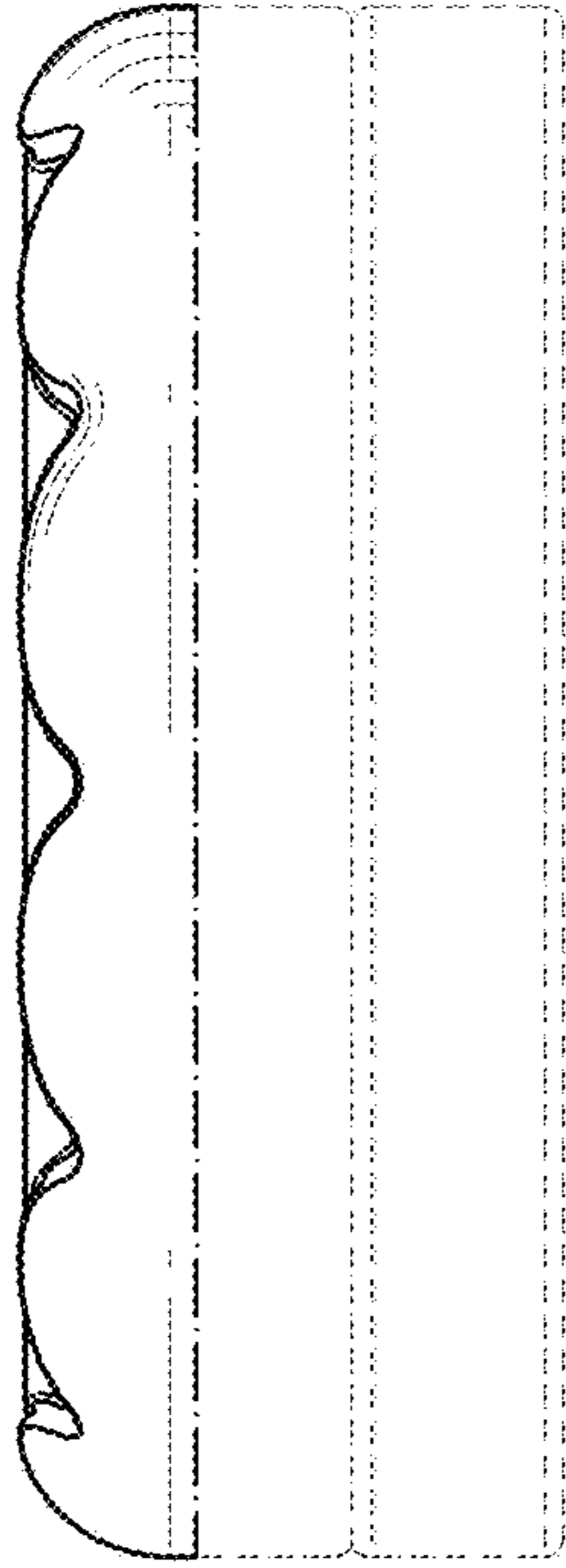

FIG. 7

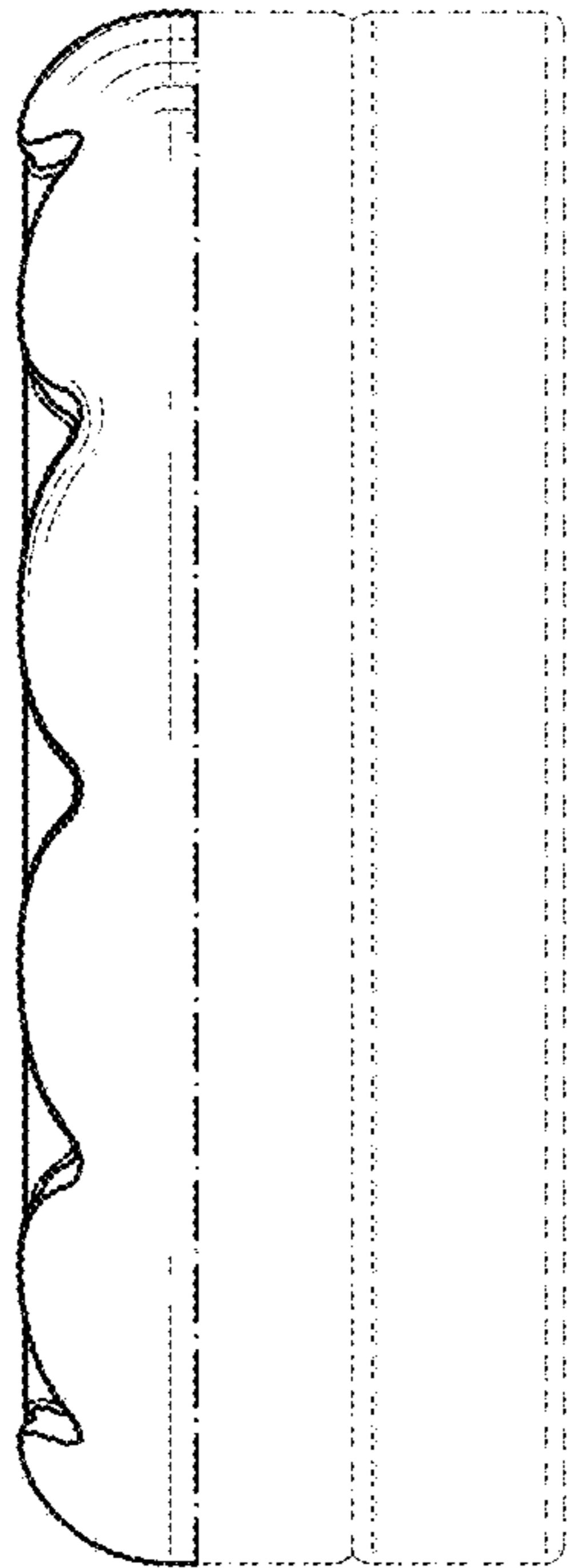

FIG. 8

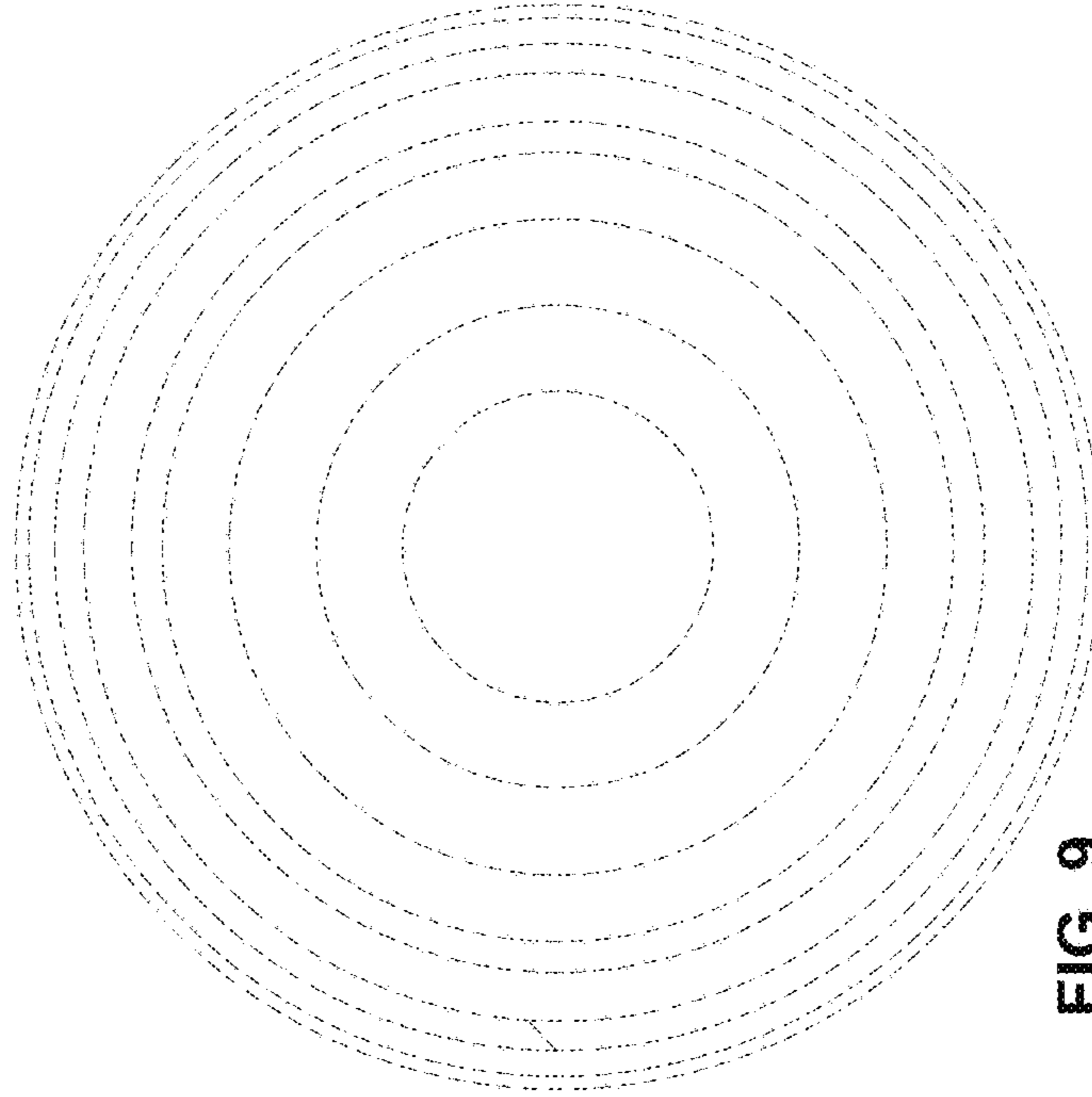

FIG. 9