



US00D830031S

(12) **United States Design Patent**  
**Hall et al.**

(10) **Patent No.:** **US D830,031 S**  
(45) **Date of Patent:** **\*\* Oct. 2, 2018**

(54) **RECEPTACLE TOPPER**

D586,521 S \* 2/2009 Pho ..... D34/11  
D658,058 S \* 4/2012 Sanges ..... D9/436  
D805,708 S \* 12/2017 Kopp ..... D34/11

(71) Applicant: **Rubbermaid Commercial Products LLC**, Atlanta, GA (US)

\* cited by examiner

(72) Inventors: **Miguel Arthur Hall**, Cornelius, NC (US); **Ryan Michael Baker**, Charlotte, NC (US); **Michael Paul Dawson**, Huntersville, NC (US); **Paul Martus**, Grand Rapids, MI (US)

*Primary Examiner* — Holly H Baynham  
(74) *Attorney, Agent, or Firm* — Eversheds Sutherland (US) LLP

(73) Assignee: **Robbermaid Commercial Products LLC**, Atlanta, GA (US)

(57) **CLAIM**

We claim the ornamental design for a receptacle topper, as shown and described.

(\*\*) Term: **15 Years**

**DESCRIPTION**

(21) Appl. No.: **29/604,639**

FIG. 1 is an upper perspective view showing a first embodiment of our new design for a receptacle topper;  
FIG. 2 is a lower perspective view showing the design of FIG. 1;  
FIG. 3 is a front view showing the design of FIG. 1;  
FIG. 4 is a back view showing the design of FIG. 1;  
FIG. 5 is a first side view showing the design of FIG. 1;  
FIG. 6 is a second side view showing the design of FIG. 1;  
FIG. 7 is a top view showing the design of FIG. 1;  
FIG. 8 is a bottom view showing the design of FIG. 1;  
FIG. 9 is a top view showing a second environmental of our new design for a receptacle topper;  
FIG. 10 is a top view showing a third environmental of our new design for a receptacle topper;  
FIG. 11 is a top view showing a fourth environmental of our new design for a receptacle topper; and,  
FIG. 12 is an environmental, reduced scale upper perspective view showing the receptacle topper of FIG. 11 disposed on a receptacle.

(22) Filed: **May 18, 2017**

(51) **LOC (11) Cl.** ..... **09-09**

(52) **U.S. Cl.**

USPC ..... **D34/11**

(58) **Field of Classification Search**

USPC ..... D34/1, 7, 11; D6/315, 318; D9/730, 734

CPC ..... B65F 1/062; B65F 1/1607; B65F 1/16;

B65F 2230/134; B65F 2230/152; B65F

2250/11; B65D 51/20; B65D 11/02

See application file for complete search history.

(56) **References Cited**

**U.S. PATENT DOCUMENTS**

D411,677 S \* 6/1999 Kennamer ..... D34/10

D481,509 S \* 10/2003 Perelli ..... D34/11

D576,371 S \* 9/2008 Zimmerman ..... D34/7

**1 Claim, 10 Drawing Sheets**

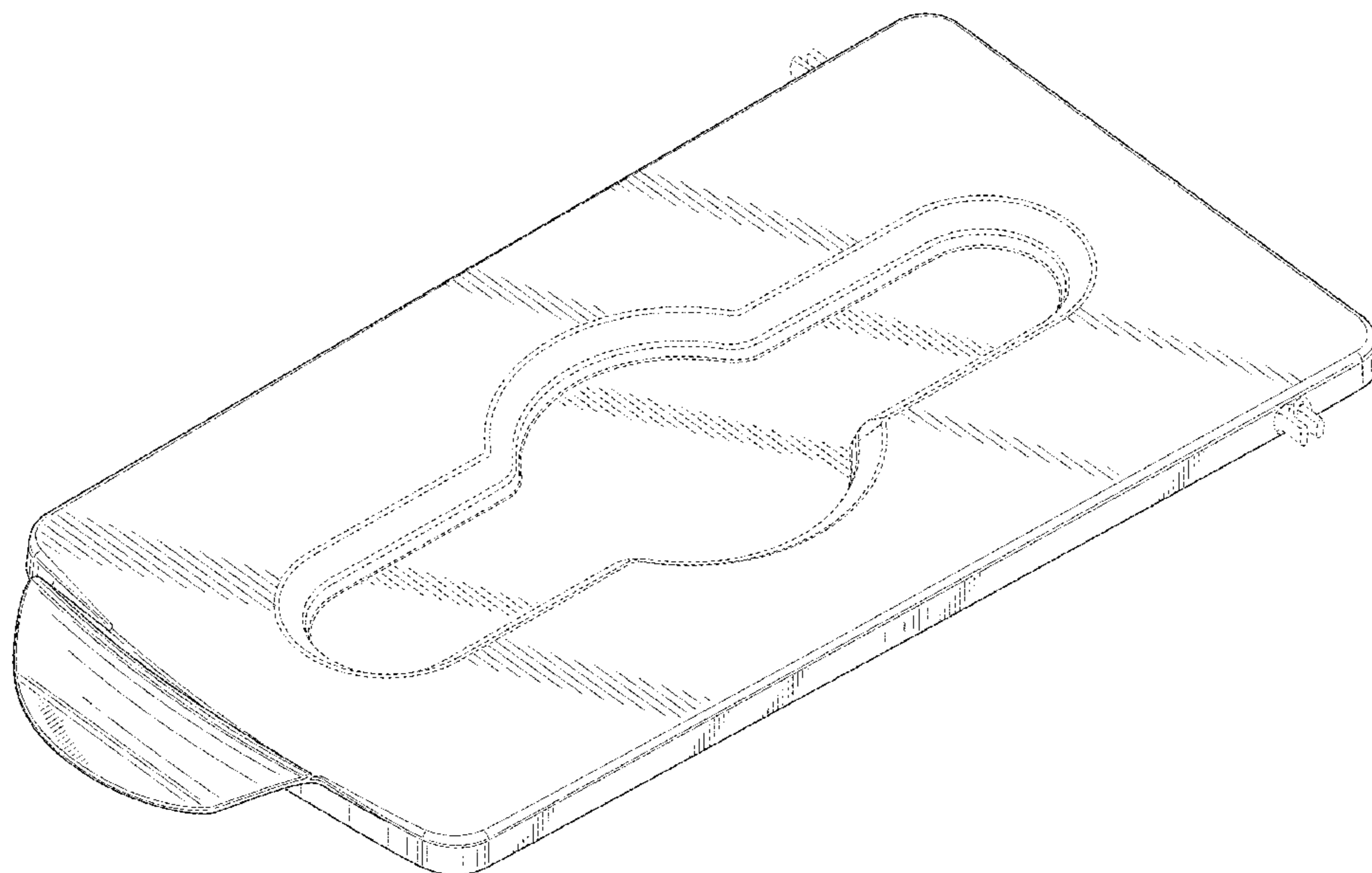

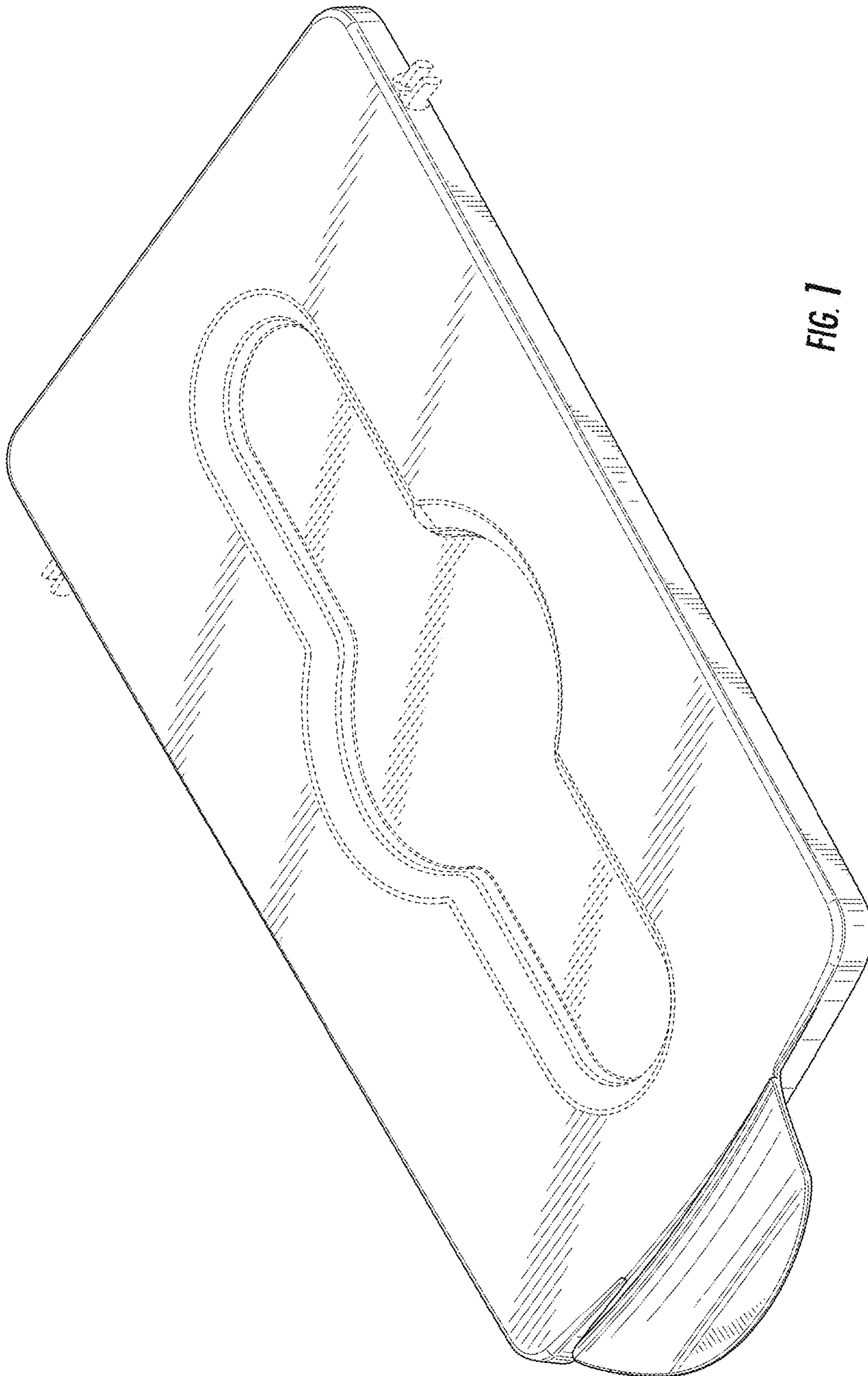

FIG. 1

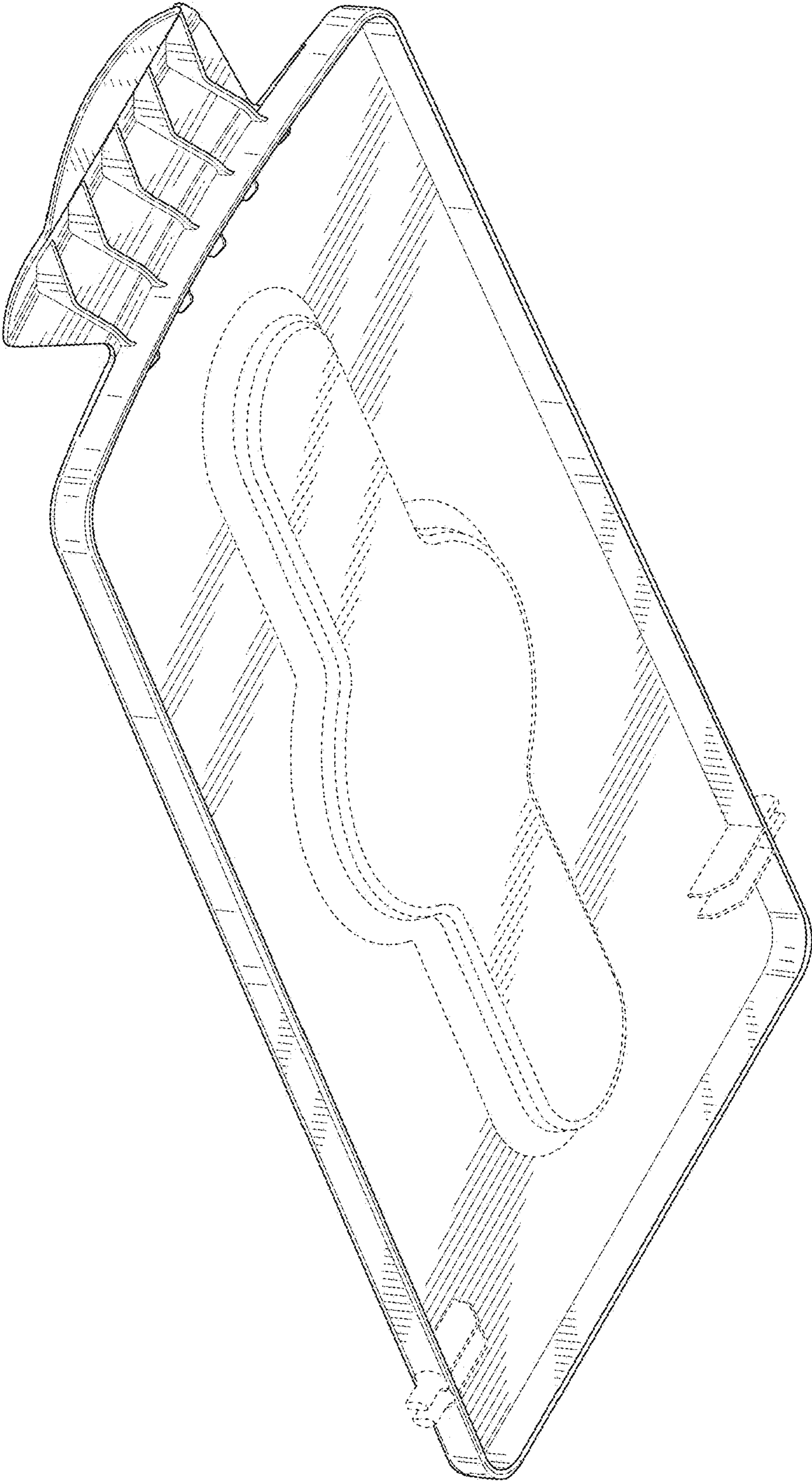

FIG. 2

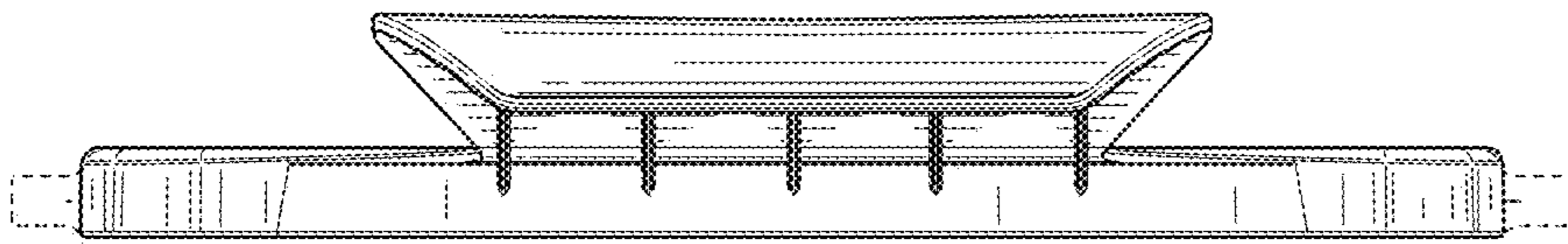

FIG. 3

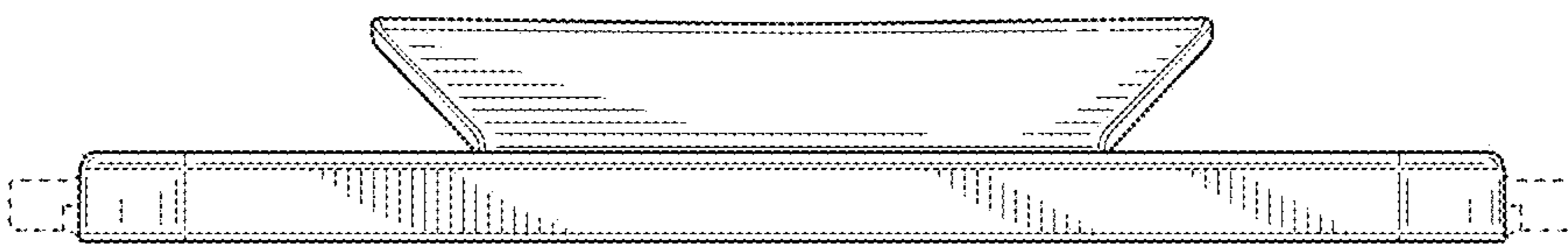

FIG. 4

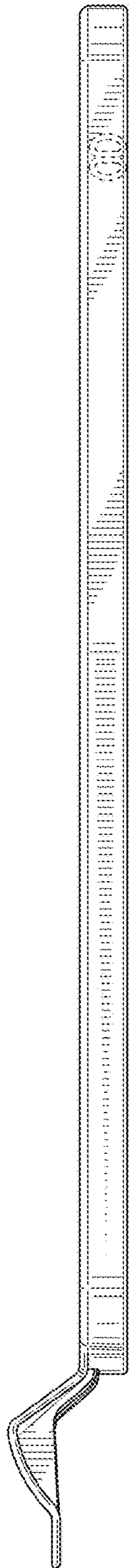

FIG. 5

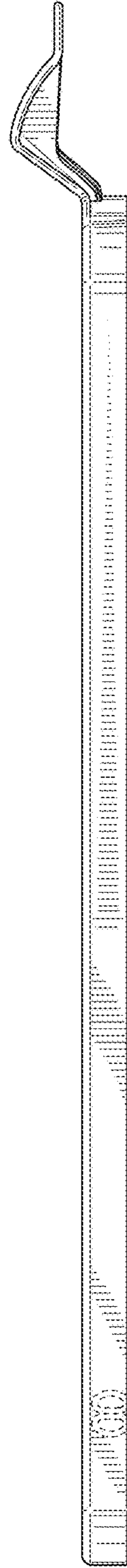

FIG. 6

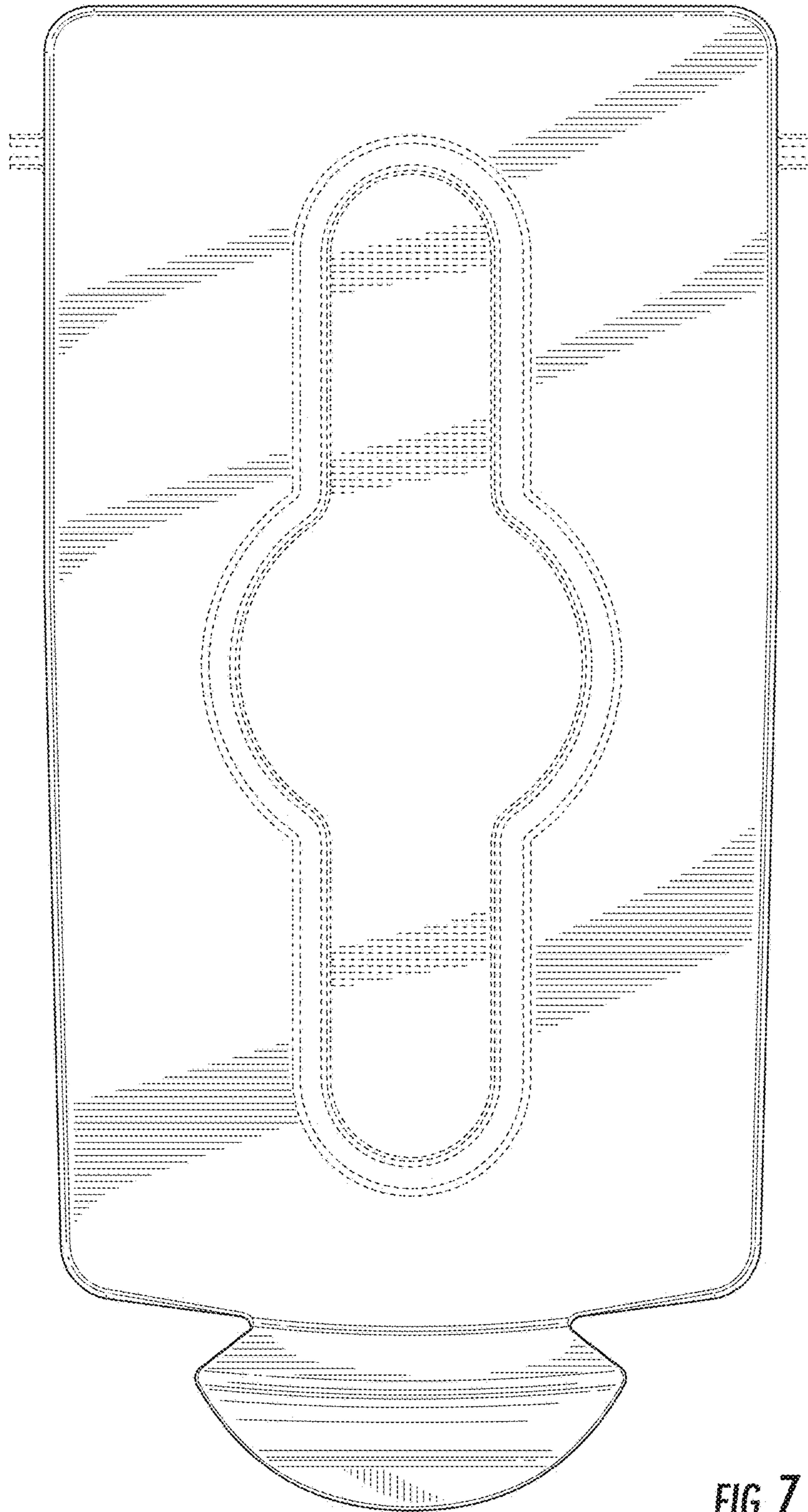

FIG. 7

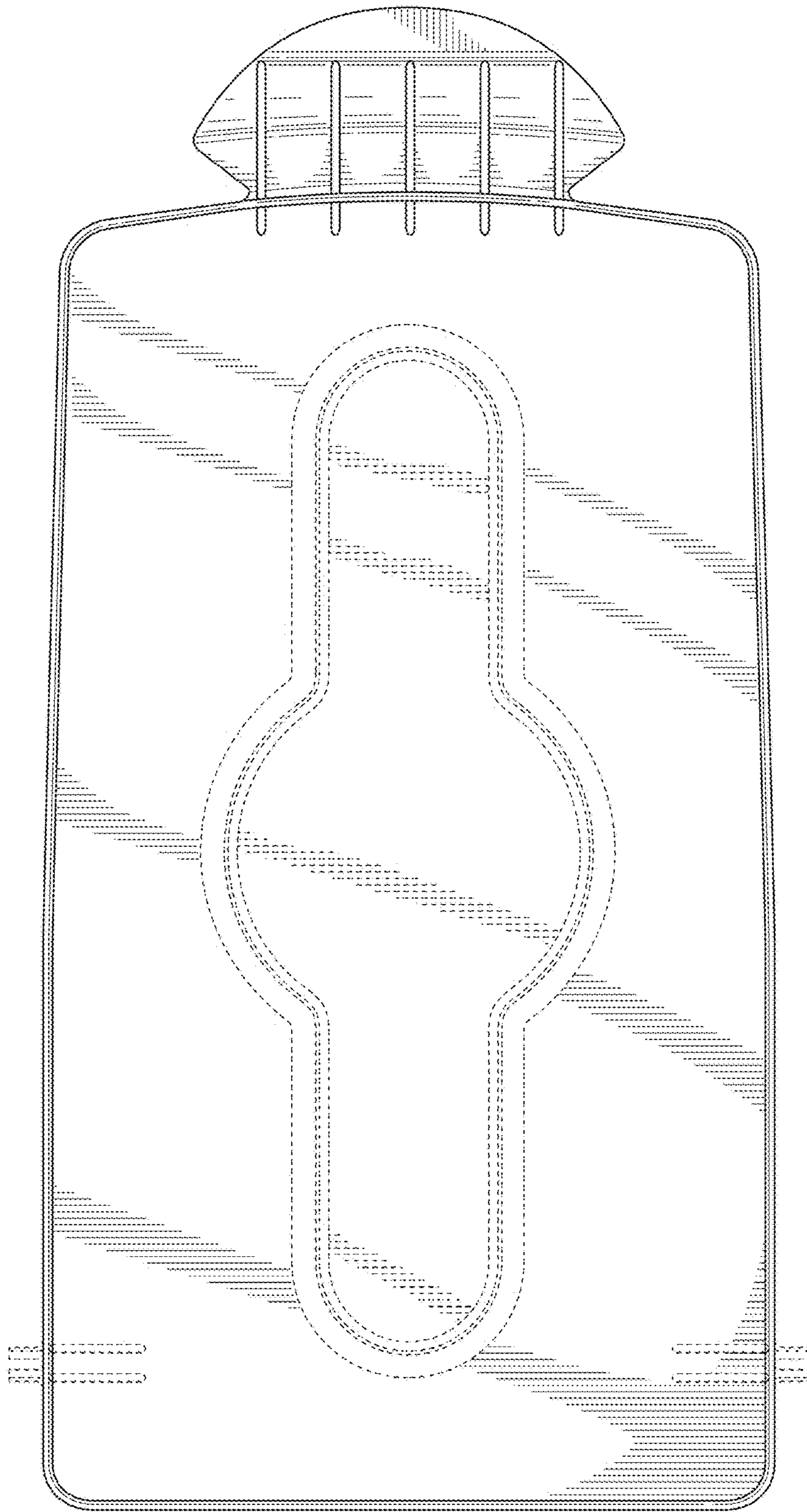

FIG. 8

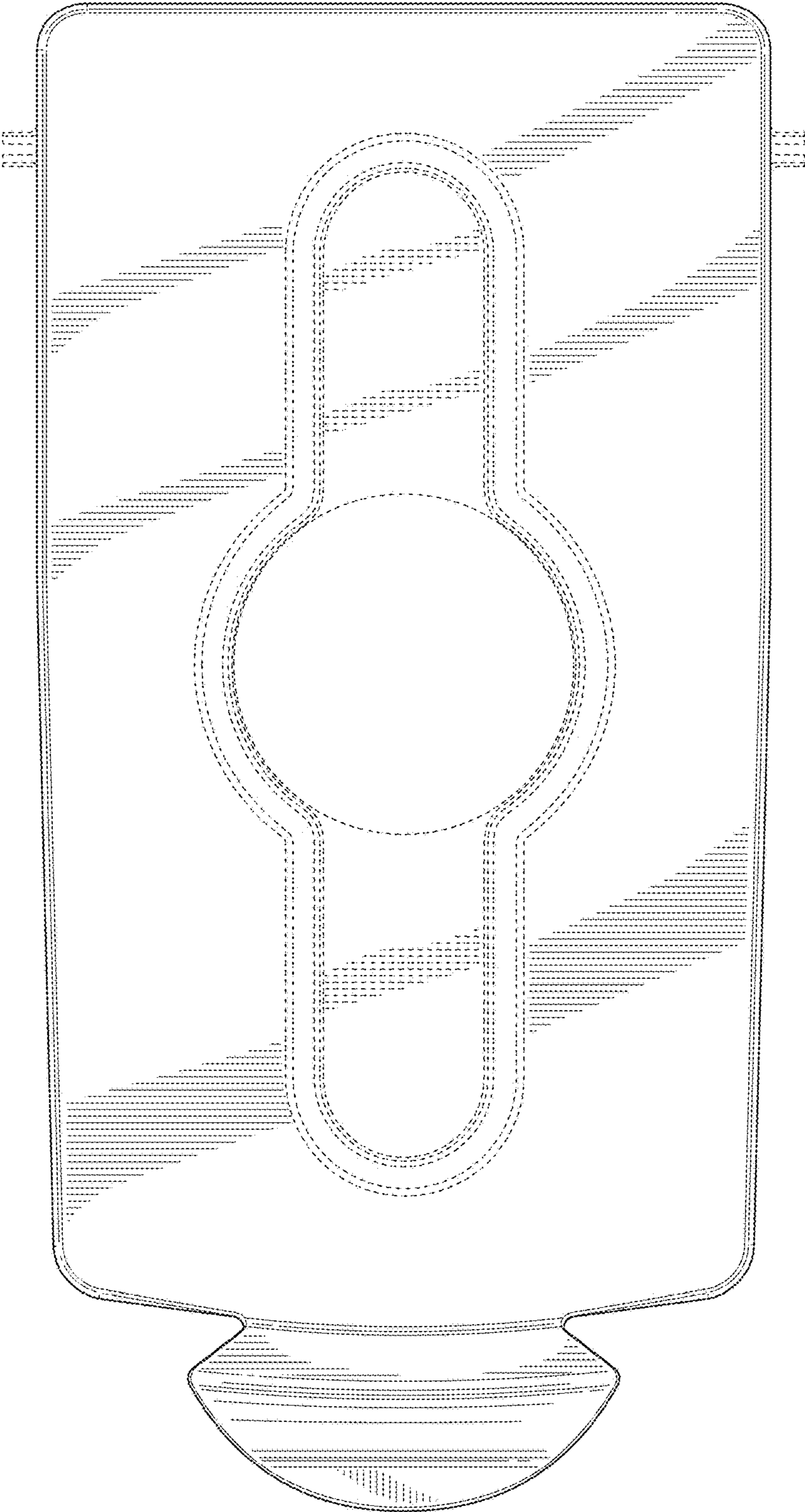

FIG. 9



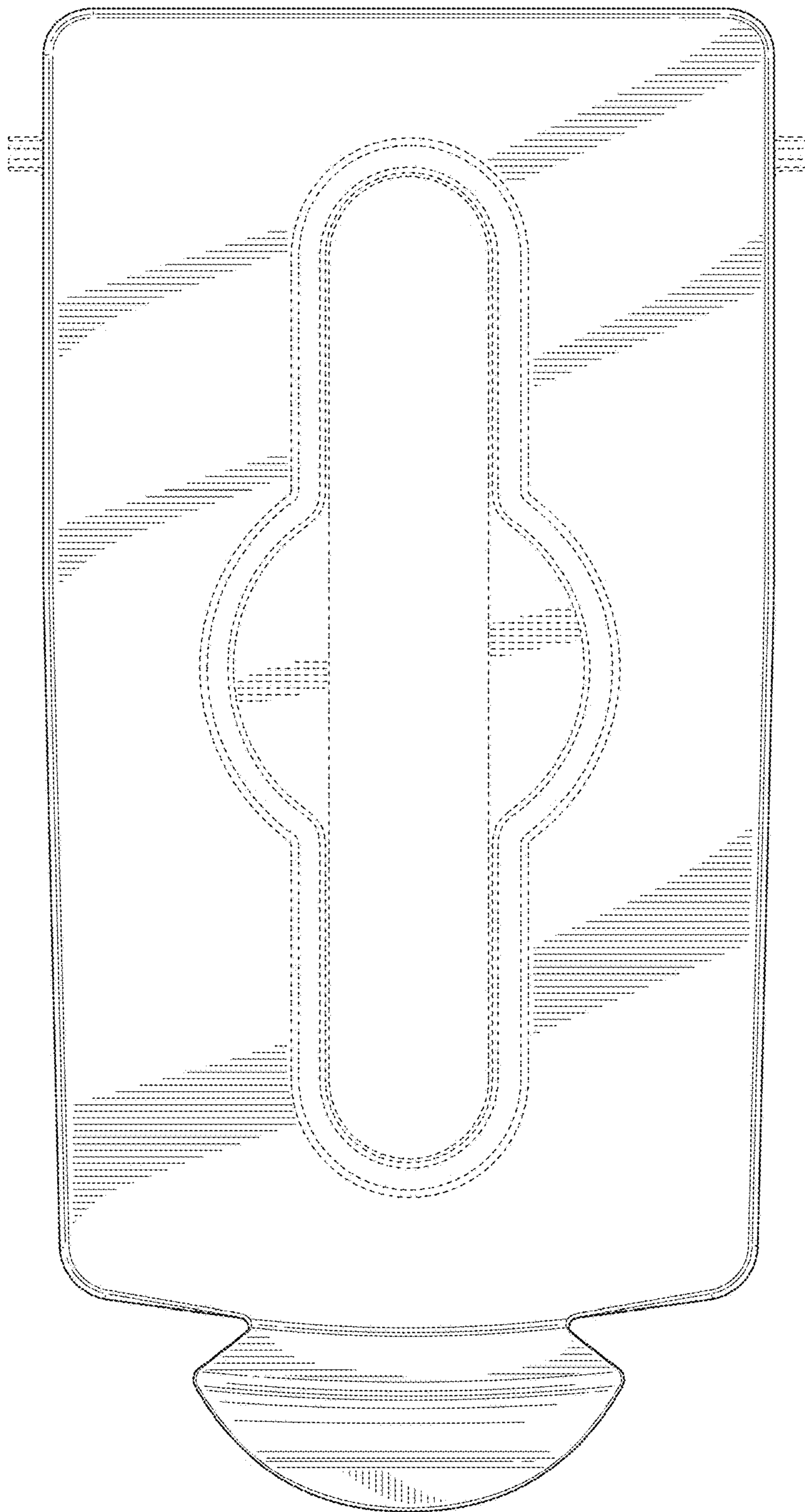

FIG. 10

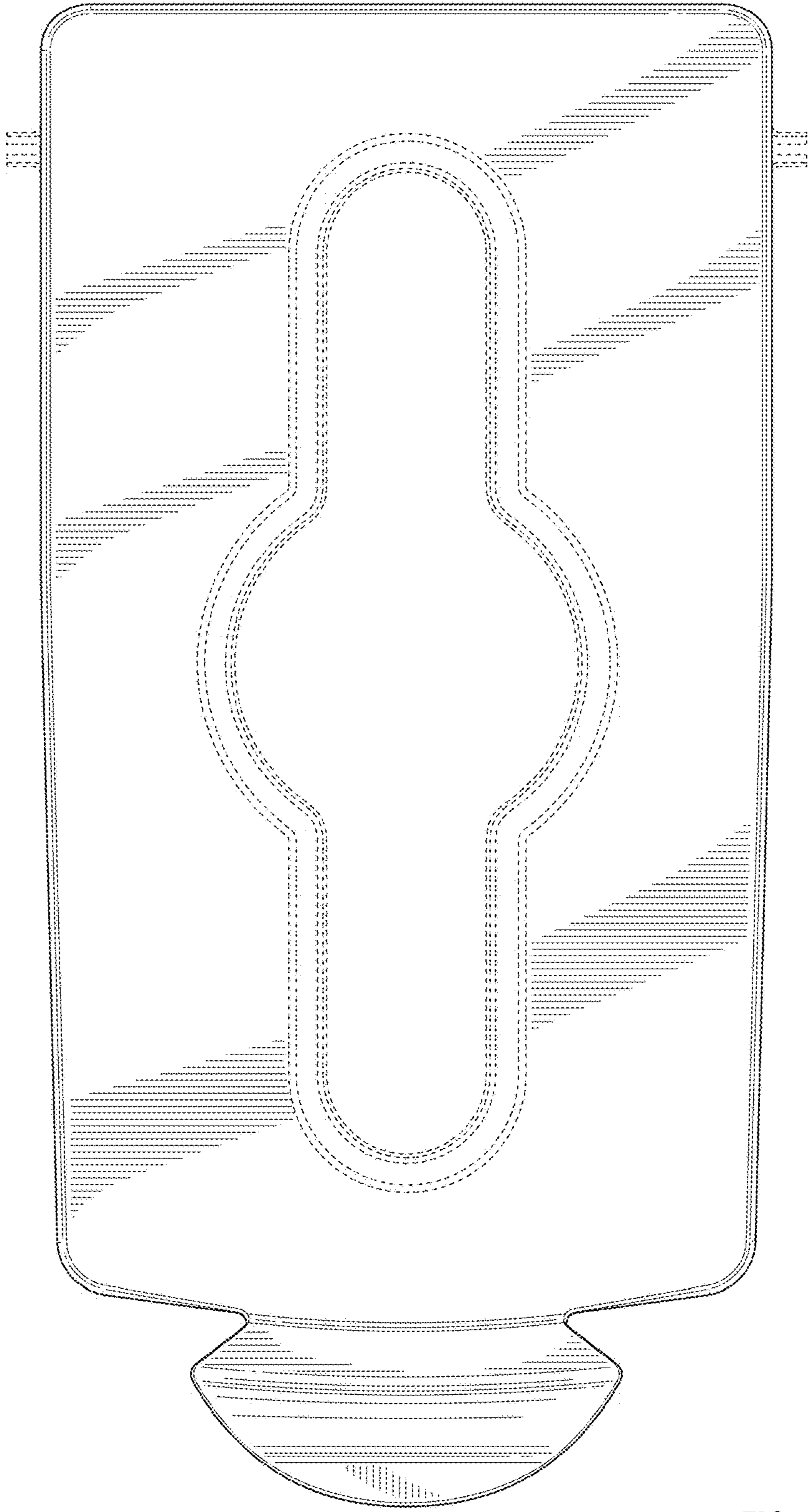
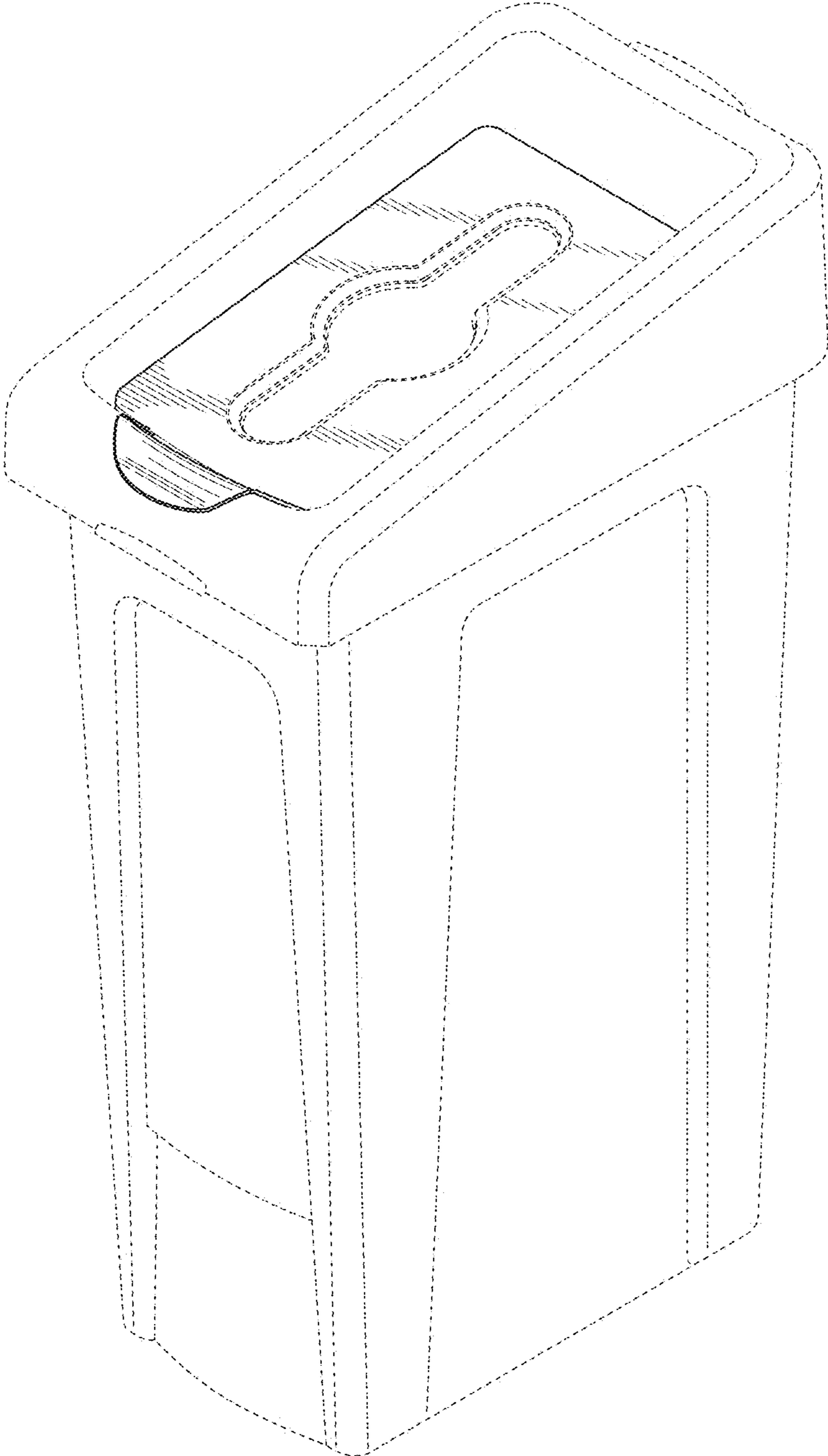

FIG. 11



**FIG. 12**