



US00D829976S

(12) **United States Design Patent** (10) **Patent No.:** **US D829,976 S**
Stone (45) **Date of Patent:** **** Oct. 2, 2018**

(54) **ELECTRONIC CIGARETTE**
(71) Applicant: **Altria Client Services LLC**,
Richmond, VA (US)
(72) Inventor: **Mitchell Stone**, Staffordshire (GB)
(73) Assignee: **ALTRIA CLIENT SERVICES LLC**,
Richmond, VA (US)

D720,499 S * 12/2014 Alima D27/167
D720,882 S 1/2015 Albanese
D722,196 S * 2/2015 Tucker D27/101
D722,956 S * 2/2015 Alima D13/103
D724,262 S 3/2015 Heam et al.
D725,310 S 3/2015 Eksouzian
D728,852 S 5/2015 Heam et al.
D732,733 S 6/2015 Spagnolo et al.
D738,566 S * 9/2015 Tucker D27/101
D738,567 S * 9/2015 Tucker D27/101

(Continued)

(**) Term: **15 Years**

FOREIGN PATENT DOCUMENTS

(21) Appl. No.: **29/592,193**

CN 303162041 S 4/2015
CN 303482767 S 12/2015

(22) Filed: **Jan. 27, 2017**

(Continued)

(30) **Foreign Application Priority Data**

OTHER PUBLICATIONS

Jul. 31, 2016 (EM) 003325349-0001
Jul. 31, 2016 (EM) 003325349-0002
Jul. 31, 2016 (EM) 003325349-0003
Jul. 31, 2016 (EM) 003325349-0004
Jul. 31, 2016 (EM) 003325349-0005
Jul. 31, 2016 (EM) 003325349-0006
Jul. 31, 2016 (EM) 003325349-0007
Jul. 31, 2016 (EM) 003325349-0008

English translation of Taiwanese Allowance Decision dated Dec. 12, 2017 in Taiwanese Application No. 106300550.

(Continued)

Primary Examiner — Brandon M Rosati
Assistant Examiner — Marissa J Cash
(74) *Attorney, Agent, or Firm* — Harness, Dickey & Pierce, PLC

(51) **LOC (11) Cl.** **27-01**

(52) **U.S. Cl.**
USPC **D27/101**

(57) **CLAIM**

(58) **Field of Classification Search**
USPC D27/100, 101, 162–170, 172–195
CPC A24F 1/30; A24F 47/002; A24F 9/14
See application file for complete search history.

The ornamental design for an electronic cigarette, as shown and described.

DESCRIPTION

(56) **References Cited**

U.S. PATENT DOCUMENTS

D532,927 S 11/2006 Sann
D683,897 S * 6/2013 Liu D27/170
D685,522 S * 7/2013 Potter D27/101
D691,766 S 10/2013 Tucker et al.
D718,492 S 11/2014 Albanese

FIG. 1 is a perspective view of an electronic cigarette;
FIG. 2 is a front view of the electronic cigarette;
FIG. 3 is a rear view of the electronic cigarette;
FIG. 4 is a left side view of the electronic cigarette;
FIG. 5 is a right side view of the electronic cigarette;
FIG. 6 is a top view of the electronic cigarette; and,
FIG. 7 is a bottom view of the electronic cigarette.

1 Claim, 7 Drawing Sheets

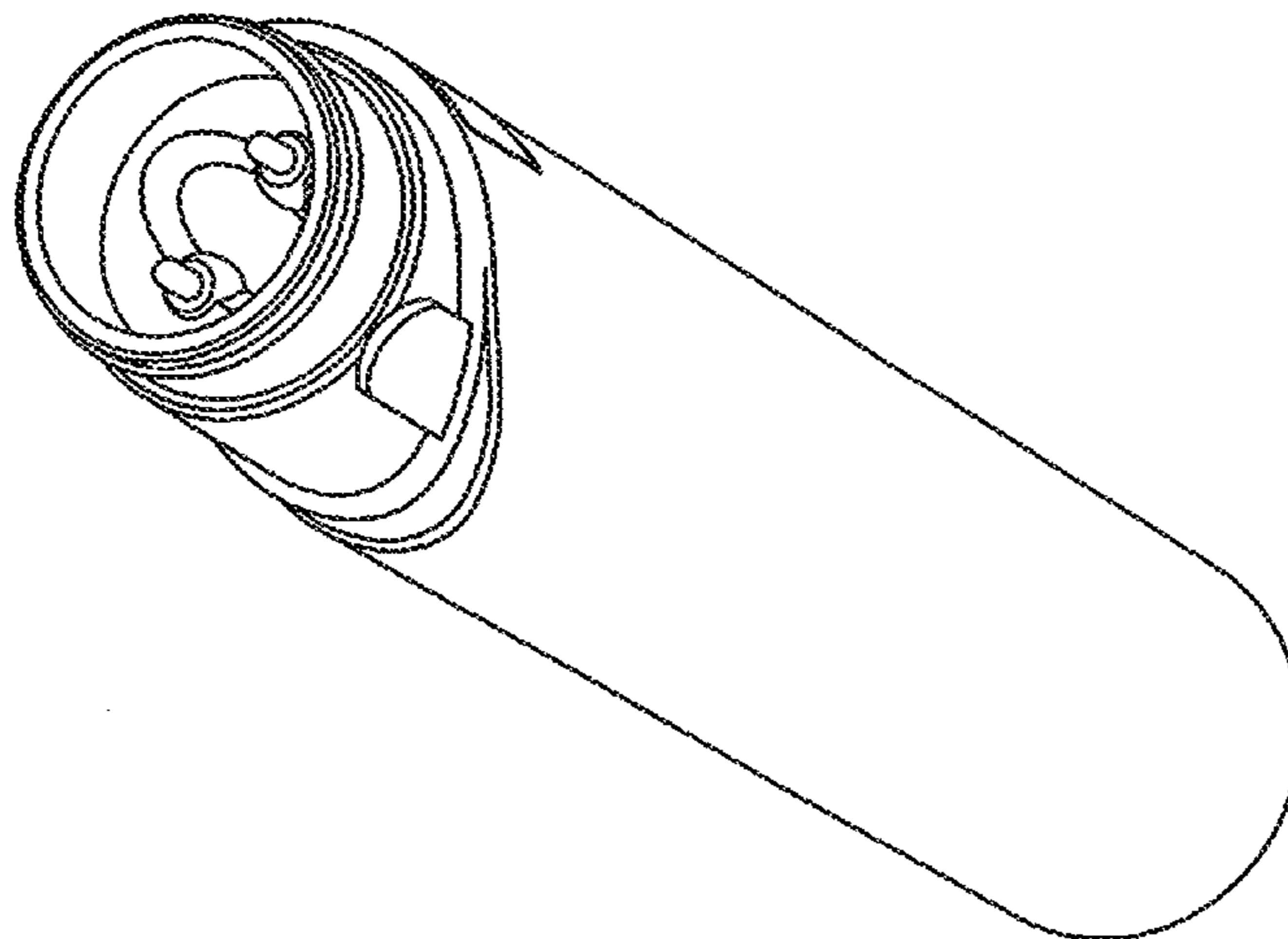

(56)

References Cited

U.S. PATENT DOCUMENTS

D742,065 S 10/2015 Leidel
 D743,097 S * 11/2015 Tucker D27/101
 D748,323 S * 1/2016 Tucker D27/101
 D752,281 S * 3/2016 Alima D27/167
 D754,919 S 4/2016 Alarcon et al.
 D756,564 S 5/2016 Yerkic-Husejnovic et al.
 D759,303 S 6/2016 Afridi
 D760,430 S 6/2016 Hanna
 D760,948 S 7/2016 Eksouzian
 D763,501 S * 8/2016 McGarry D27/101
 D763,503 S 8/2016 Bramley et al.
 D764,098 S * 8/2016 Liu D27/101
 D767,820 S 9/2016 Jordan et al.
 D769,518 S * 10/2016 Liu D27/101
 D773,727 S 12/2016 Eksouzian
 D776,337 S 1/2017 Levin et al.
 D776,868 S * 1/2017 Rado D27/162
 D778,493 S * 2/2017 Scott D27/101
 D779,719 S 2/2017 Qiu
 D779,725 S 2/2017 Bramley et al.
 D780,993 S * 3/2017 Bramley D27/170
 D782,108 S 3/2017 Jordan et al.
 D786,497 S 5/2017 Sudlow et al.
 D787,114 S * 5/2017 Scott D27/194
 D790,123 S 6/2017 Beer et al.
 D792,643 S 7/2017 Wong et al.
 D795,495 S * 8/2017 Li D27/100
 D795,496 S * 8/2017 Beer D27/101
 D797,990 S 9/2017 Hawes et al.
 D799,108 S * 10/2017 Meyer D27/101
 D799,110 S 10/2017 Qiu
 D799,113 S 10/2017 Qiu
 D799,741 S 10/2017 Liu
 D799,744 S 10/2017 Qiu
 D799,745 S * 10/2017 Qiu D27/101
 D799,749 S 10/2017 Freese
 D800,381 S 10/2017 Chen
 D800,383 S 10/2017 Verleur et al.
 D802,207 S * 11/2017 Bramley D27/170
 D802,835 S 11/2017 Bagai
 D802,839 S 11/2017 Scott
 D803,475 S * 11/2017 Scheiber D27/101
 D804,090 S * 11/2017 Verleur D27/101
 D804,091 S * 11/2017 Fornarelli D27/101
 2013/0319438 A1 * 12/2013 Liu A24F 47/008
 131/329
 2014/0060524 A1 * 3/2014 Liu A24F 47/008
 128/200.14
 2015/0034104 A1 2/2015 Zhou
 2015/0059784 A1 * 3/2015 Liu A24F 47/008
 131/329
 2015/0128973 A1 5/2015 Li et al.
 2015/0296889 A1 * 10/2015 Liu A24F 47/008
 131/329
 2015/0313288 A1 * 11/2015 Liu A24F 47/008
 131/329

2015/0335072 A1 * 11/2015 Giller F21V 33/0004
 131/328
 2016/0073692 A1 * 3/2016 Alarcon A24F 47/008
 131/329
 2016/0073694 A1 * 3/2016 Liu A24F 47/008
 131/329
 2016/0113327 A1 * 4/2016 Wu A24F 47/008
 131/329
 2016/0120222 A1 * 5/2016 Bagai A24F 47/008
 131/329
 2016/0120226 A1 * 5/2016 Rado A24F 47/008
 131/329
 2016/0121058 A1 * 5/2016 Chen A61M 11/04
 128/200.19
 2016/0331912 A1 11/2016 Trzeczieski
 2016/0345626 A1 12/2016 Wong et al.
 2016/0374396 A1 12/2016 Jordan et al.
 2016/0374397 A1 12/2016 Jordan et al.

FOREIGN PATENT DOCUMENTS

CN	303657684 S	4/2016
TW	D148448	8/2012
TW	D155436	8/2013
TW	D155654	8/2013

OTHER PUBLICATIONS

English translation of Taiwanese Allowance Decision dated Dec. 12, 2017 in Taiwanese Application No. 106300548.
 English translation of Taiwanese Office Action dated Dec. 27, 2017 in Taiwanese Application No. 106300549.
 U.S. Notice of Allowance and Corrected Notice of Allowance dated Jan. 17, 2018 and Feb. 13, 2018 in related U.S. Appl. No. 29/592,199.
 U.S. Office Action dated Jan. 4, 2018 in related U.S. Appl. No. 29/592,185.
 U.S. Office Action dated Jan. 4, 2018 in related U.S. Appl. No. 29/592,202.
 U.S. Office Action dated Jan. 5, 2018 in related U.S. Appl. No. 29/592,191.
 U.S. Office Action dated Jan. 4, 2018 in related U.S. Appl. No. 29/592,186.
 U.S. Office Action dated Jan. 4, 2018 in related U.S. Appl. No. 29/592,200.
 U.S. Office Action dated Jan. 5, 2018 in related U.S. Appl. No. 29/592,211.
 U.S. Appl. No. 29/592,199, filed Jan. 27, 2017.
 U.S. Appl. No. 29/592,185, filed Jan. 27, 2017.
 U.S. Appl. No. 29/592,202 filed Jan. 27, 2017.
 U.S. Appl. No. 29/592,191, filed Jan. 27, 2017.
 U.S. Appl. No. 29/592,186, filed Jan. 27, 2017.
 U.S. Appl. No. 29/592,200, filed Jan. 27, 2017.
 U.S. Appl. No. 29/592,211, filed Jan. 27, 2017.

* cited by examiner

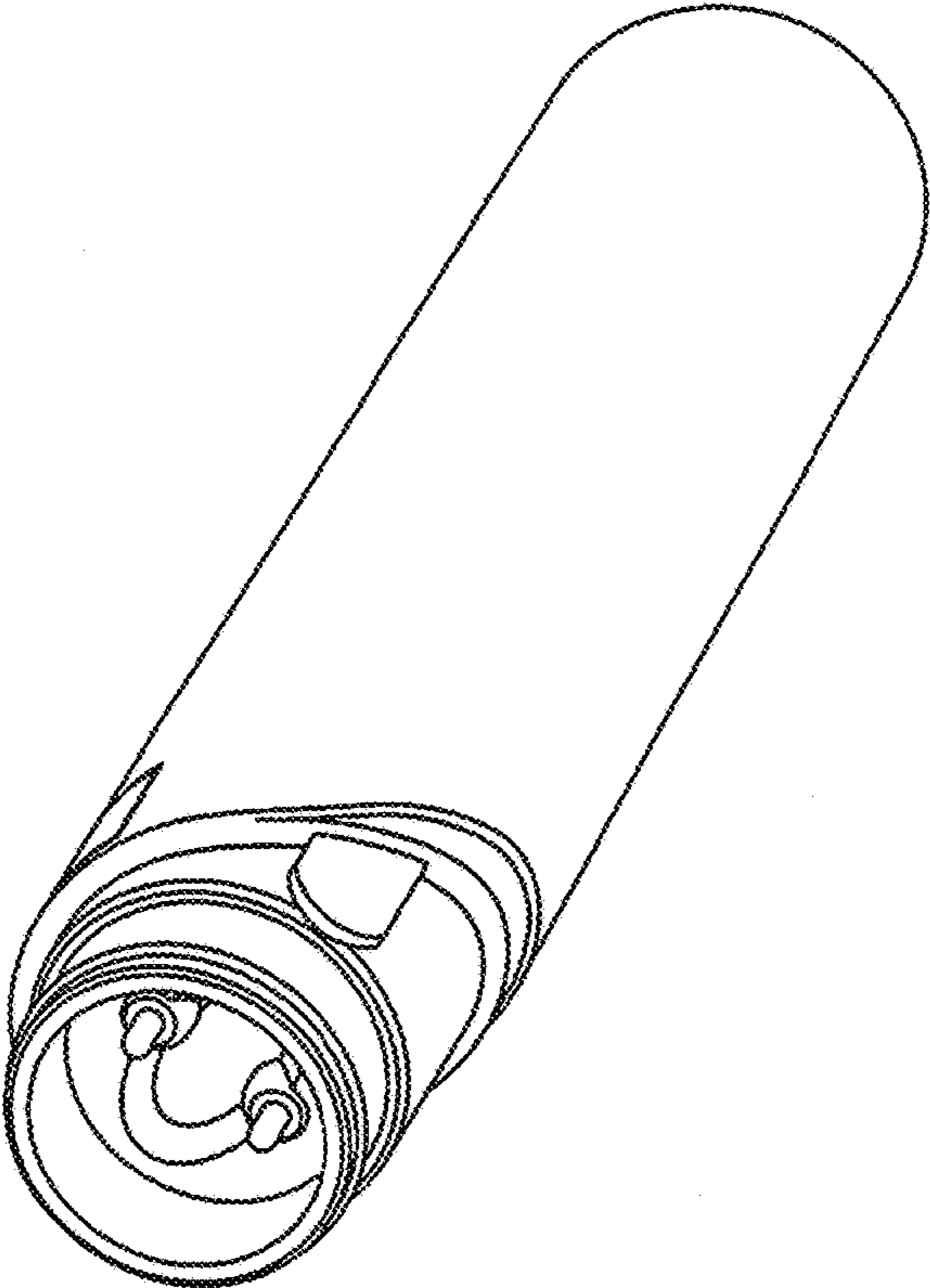

FIG. 1

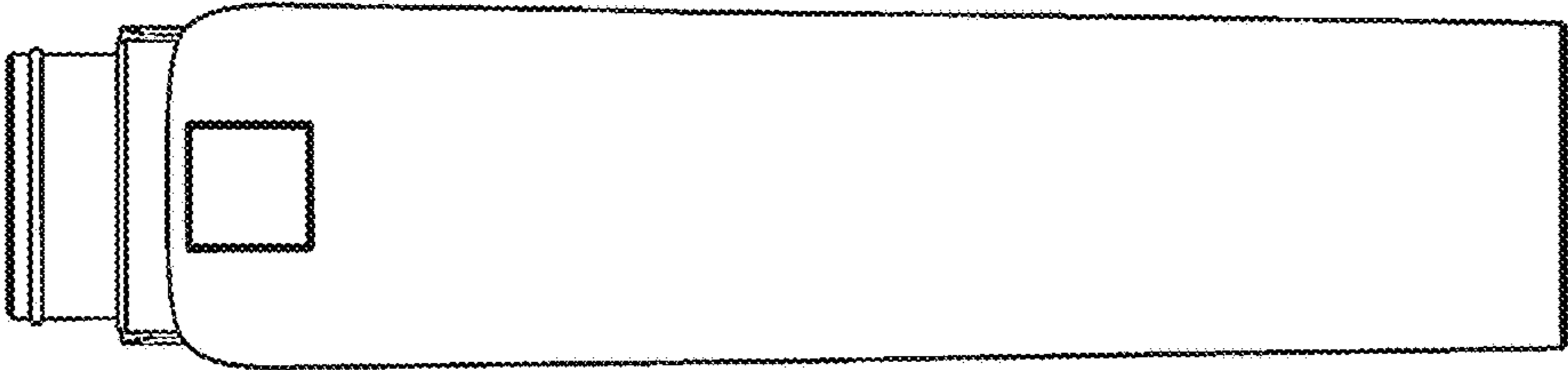

FIG. 2

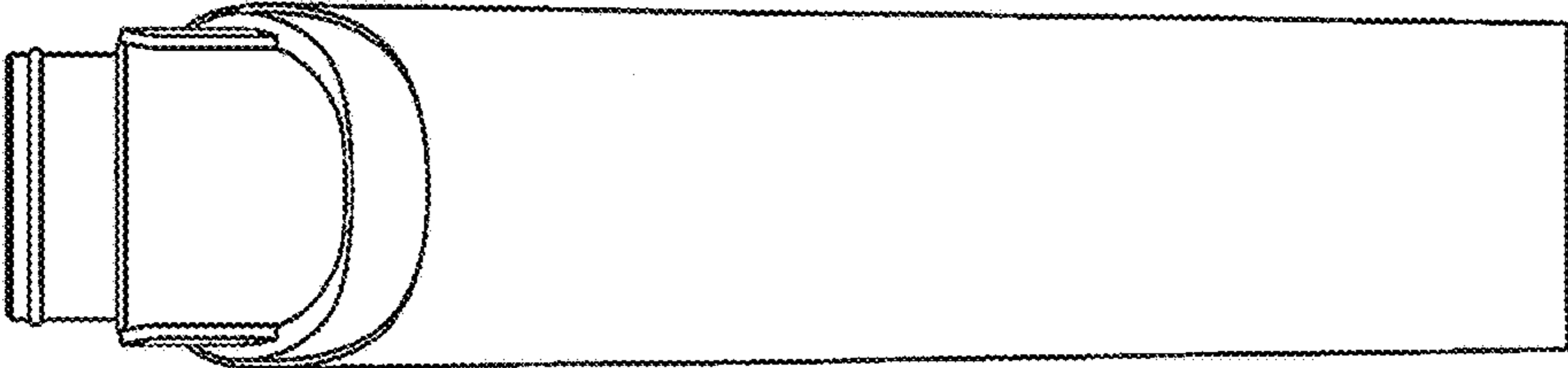

FIG. 3

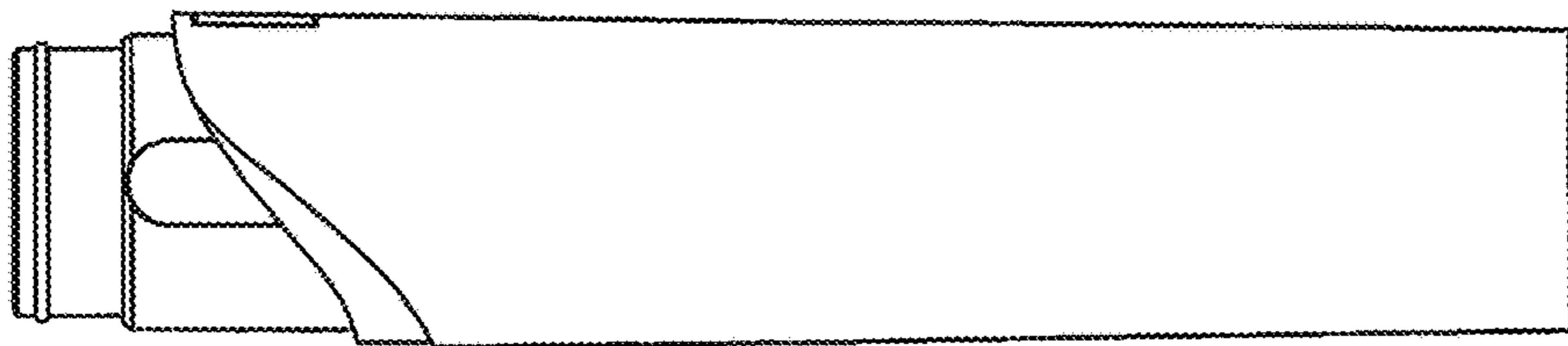

FIG. 4

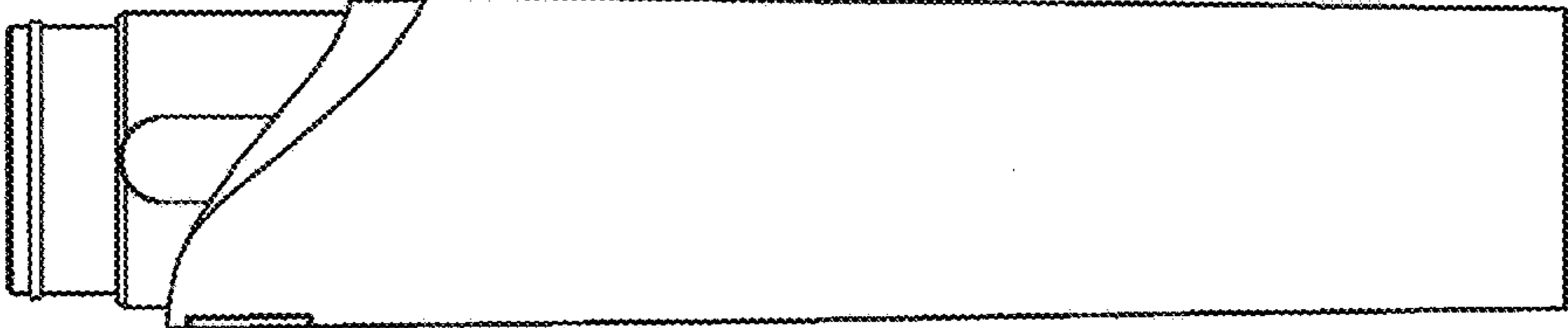

FIG. 5

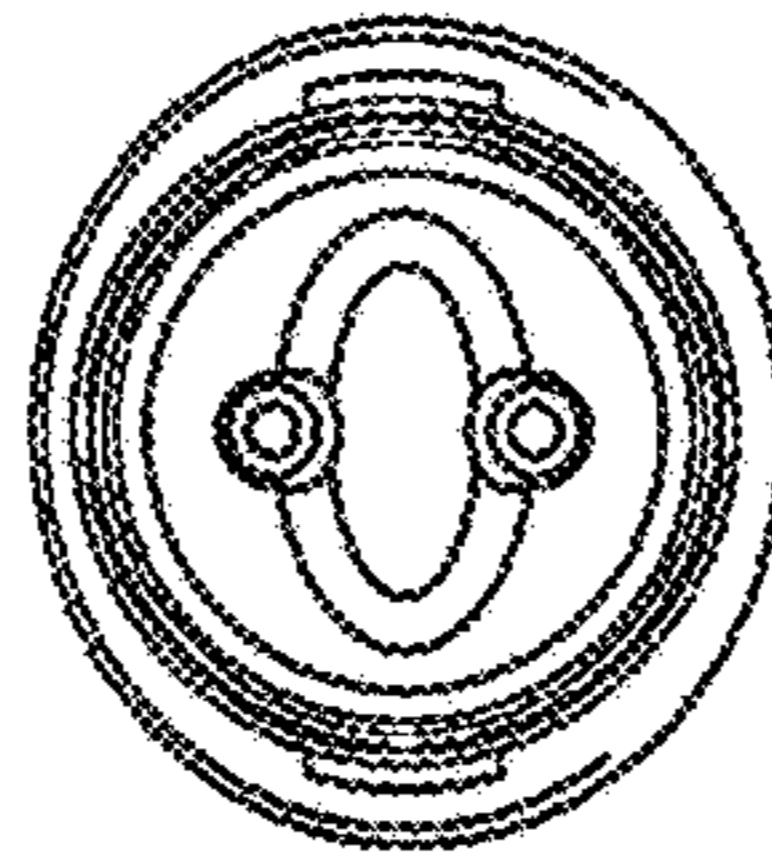

FIG. 6

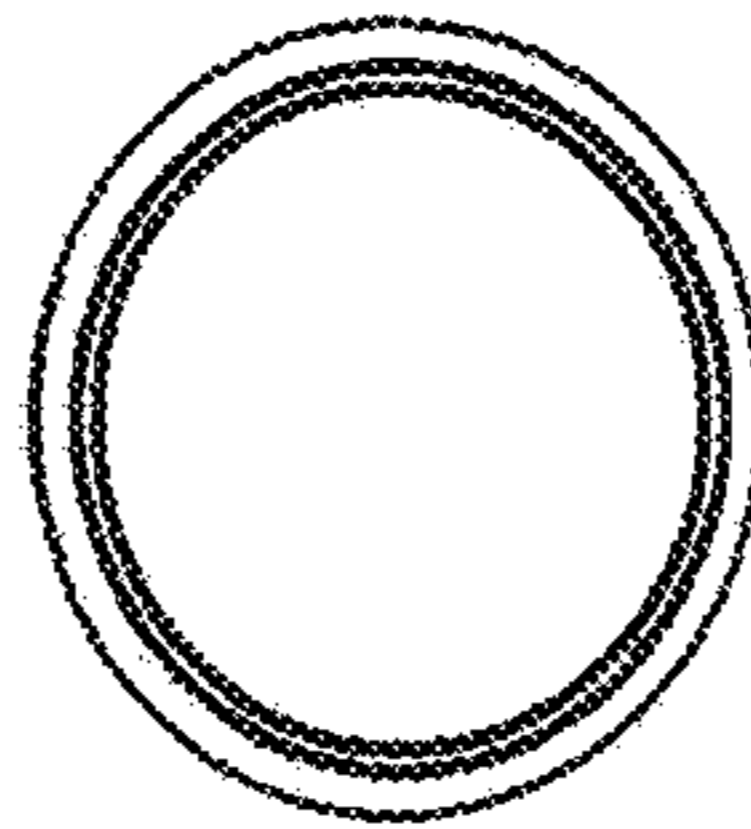

FIG. 7