



US00D829934S

(12) **United States Design Patent**
Burnquist

(10) **Patent No.:** **US D829,934 S**

(45) **Date of Patent:** **** Oct. 2, 2018**

(54) **CONCRETE BUILDING BLOCK**

(71) Applicant: **Anchor Wall Systems, Inc.**,
Minnetonka, MN (US)

(72) Inventor: **Robert Brian Burnquist**, Chaska, MN
(US)

(73) Assignee: **Anchor Wall Systems, Inc.**,
Minnetonka, MN (US)

(**) Term: **15 Years**

(21) Appl. No.: **29/581,366**

(22) Filed: **Oct. 18, 2016**

(51) **LOC (11) Cl.** **25-01**

(52) **U.S. Cl.**
USPC **D25/115**

(58) **Field of Classification Search**
USPC D21/484-491, 499-504; D25/102-118,
D25/136, 138, 140, 151-153, 156-162,
D25/164
CPC ... E01C 5/00; E01C 5/06; E01C 5/005; E01C
9/004; E01C 2201/16; E04B 2/08; E04B
2/12; E04B 2/18; E04B 2/32; E04B 2/56;
E04B 2/70; E04B 2/702; E04B
2002/0219; E04B 2002/0221; E04B
2002/0234; A63H 33/00; A63H 33/04;
A63H 33/044; A63H 33/06; A63H 33/08;
A63H 33/084; A63H 33/086; A63H
33/088; A63H 33/10; A63H 33/12; A63H
33/105; A63H 33/108

See application file for complete search history.

(56) **References Cited**

U.S. PATENT DOCUMENTS

D30,550 S * 4/1899 Camp D25/115
1,485,007 A * 2/1924 Zahn E04B 2/12
428/600

D458,693 S 6/2002 Sievert
(Continued)

Primary Examiner — Susan B Hattan

Assistant Examiner — Leanne D Was-Englehart

(74) *Attorney, Agent, or Firm* — Merchant & Gould P.C.

(57) **CLAIM**

The ornamental design for a concrete building block, as shown and described.

DESCRIPTION

FIG. 1 is a top perspective view of a first embodiment of a concrete building block, according to the new design; FIG. 2 is a front view of the embodiment of FIG. 1; FIG. 3 is a rear view of the embodiment of FIG. 1; FIG. 4 is a right side of the embodiment of FIG. 1; FIG. 5 is a left side of the embodiment of FIG. 1; FIG. 6 is a top plan of the embodiment of FIG. 1; FIG. 7 is a bottom plan of the embodiment of FIG. 1; FIG. 8 is a bottom perspective of the embodiment of FIG. 1; FIG. 9 is a top perspective of a second embodiment of a concrete building block, according to the new design, the portions shown in broken lines forming no part of the claimed design; FIG. 10 is a front view of the embodiment of FIG. 9, the portions shown in broken lines forming no part of the claimed design; FIG. 11 is a rear view of the embodiment of FIG. 9, the portions shown in broken lines forming no part of the claimed design; FIG. 12 is a right side view of the embodiment of FIG. 9; FIG. 13 is a left side view of the embodiment of FIG. 9; FIG. 14 is a top plan of the embodiment of FIG. 9, the portions shown in broken lines forming no part of the claimed design; FIG. 15 is a bottom plan of the embodiment of FIG. 9, the portions shown in broken lines forming no part of the claimed design; and, FIG. 16 is a bottom perspective of the embodiment of FIG. 9, the portions shown in broken lines forming no part of the claimed design.

1 Claim, 12 Drawing Sheets

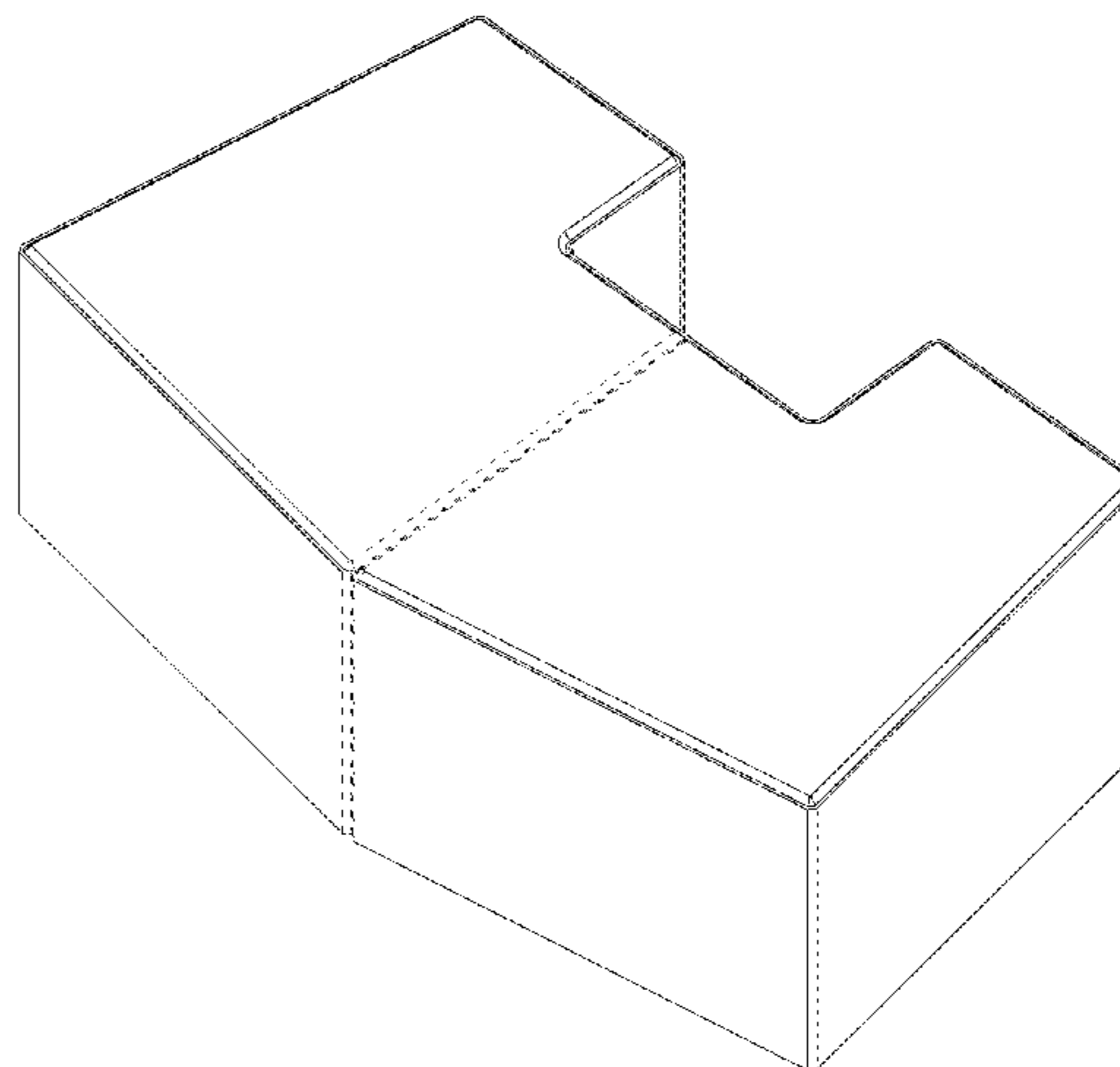
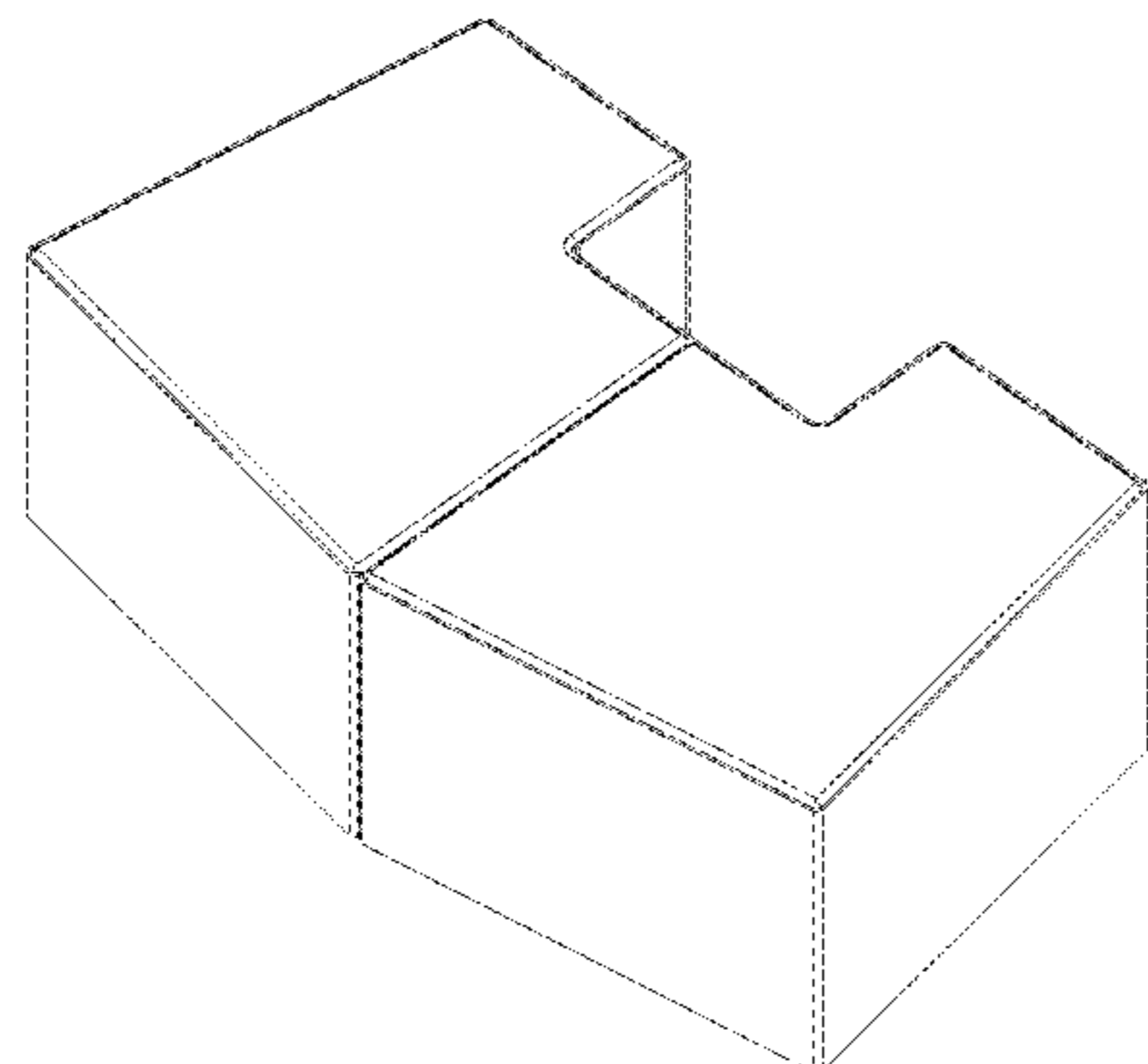

(56)

References Cited

U.S. PATENT DOCUMENTS

D729,414 S *	5/2015	Johnson	D25/113
D767,045 S *	9/2016	Timg	D21/497
D781,455 S *	3/2017	Risi	D25/113
D796,066 S *	8/2017	Shell	D25/113

* cited by examiner

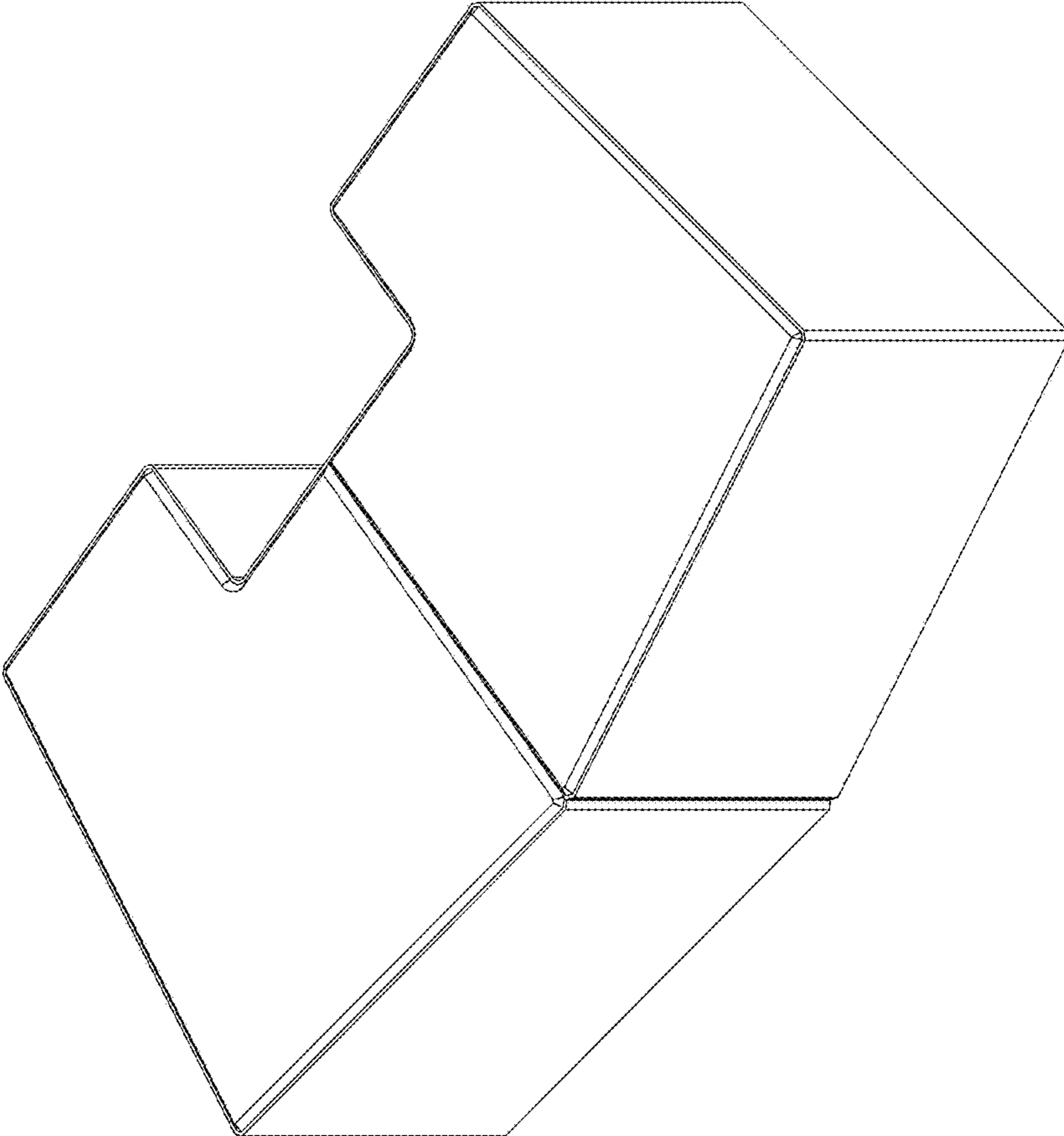

FIG. 1

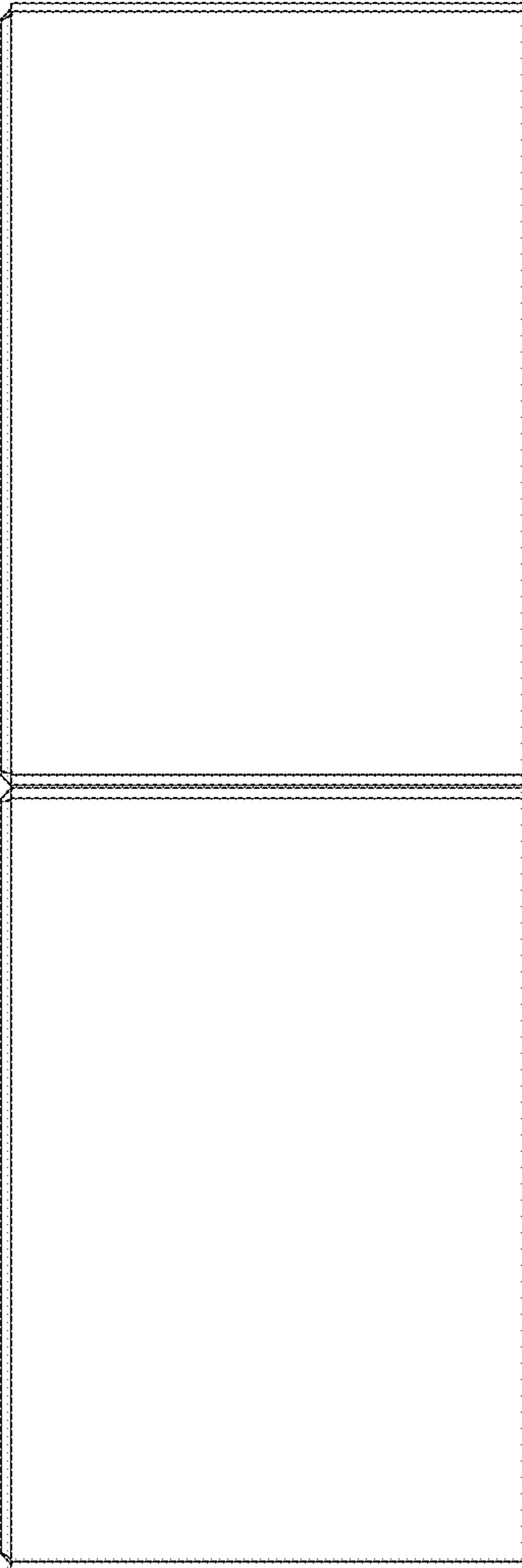

FIG. 2

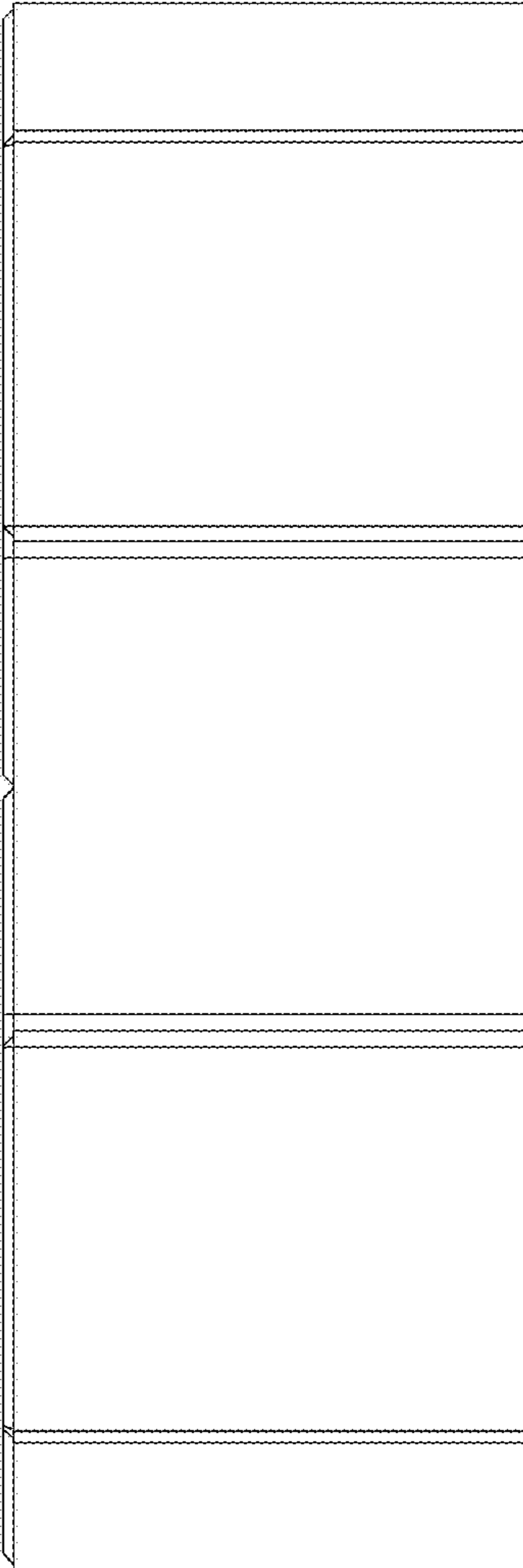

FIG. 3

FIG. 4

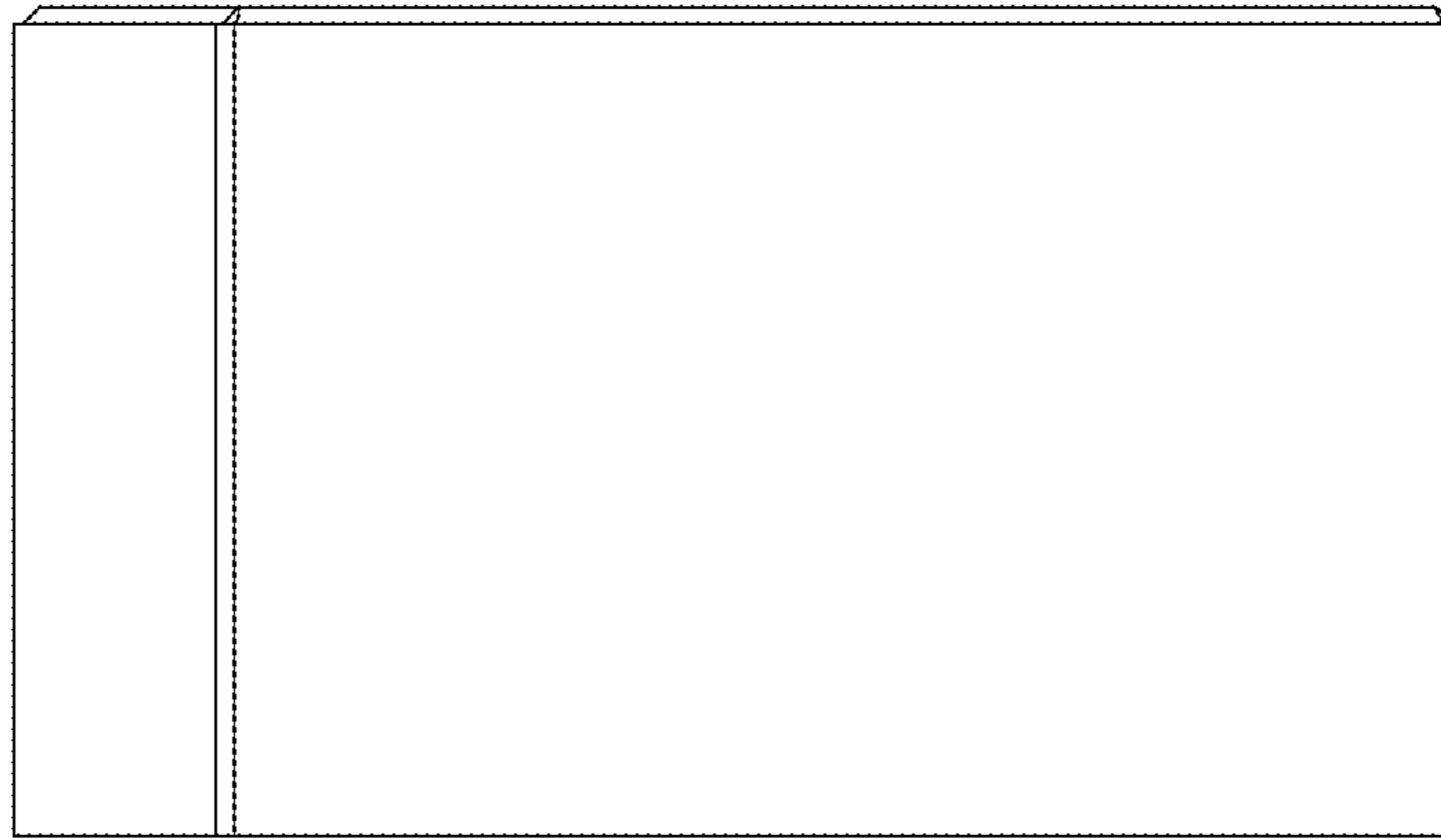

FIG. 5



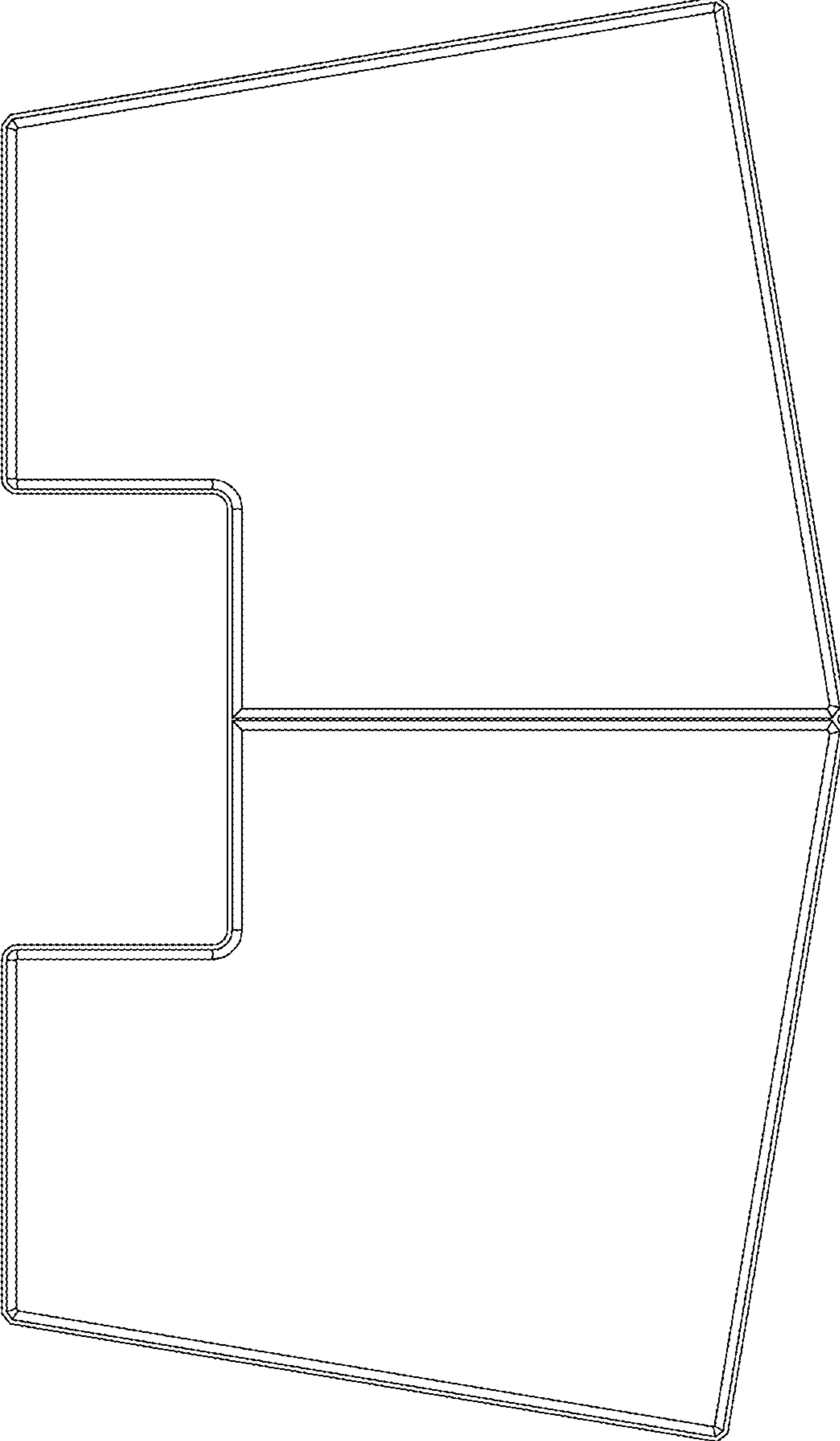

FIG. 6

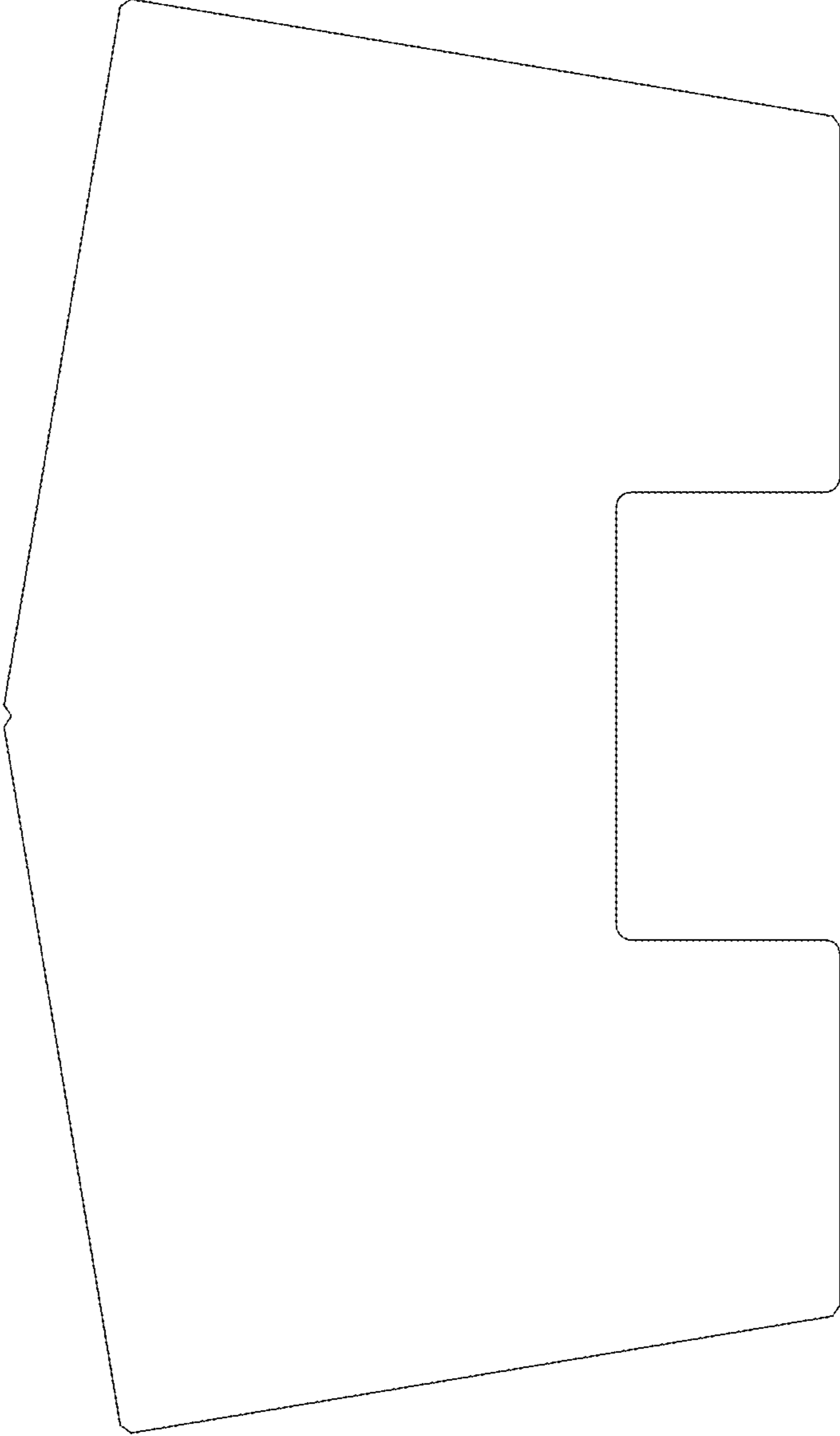

FIG. 7

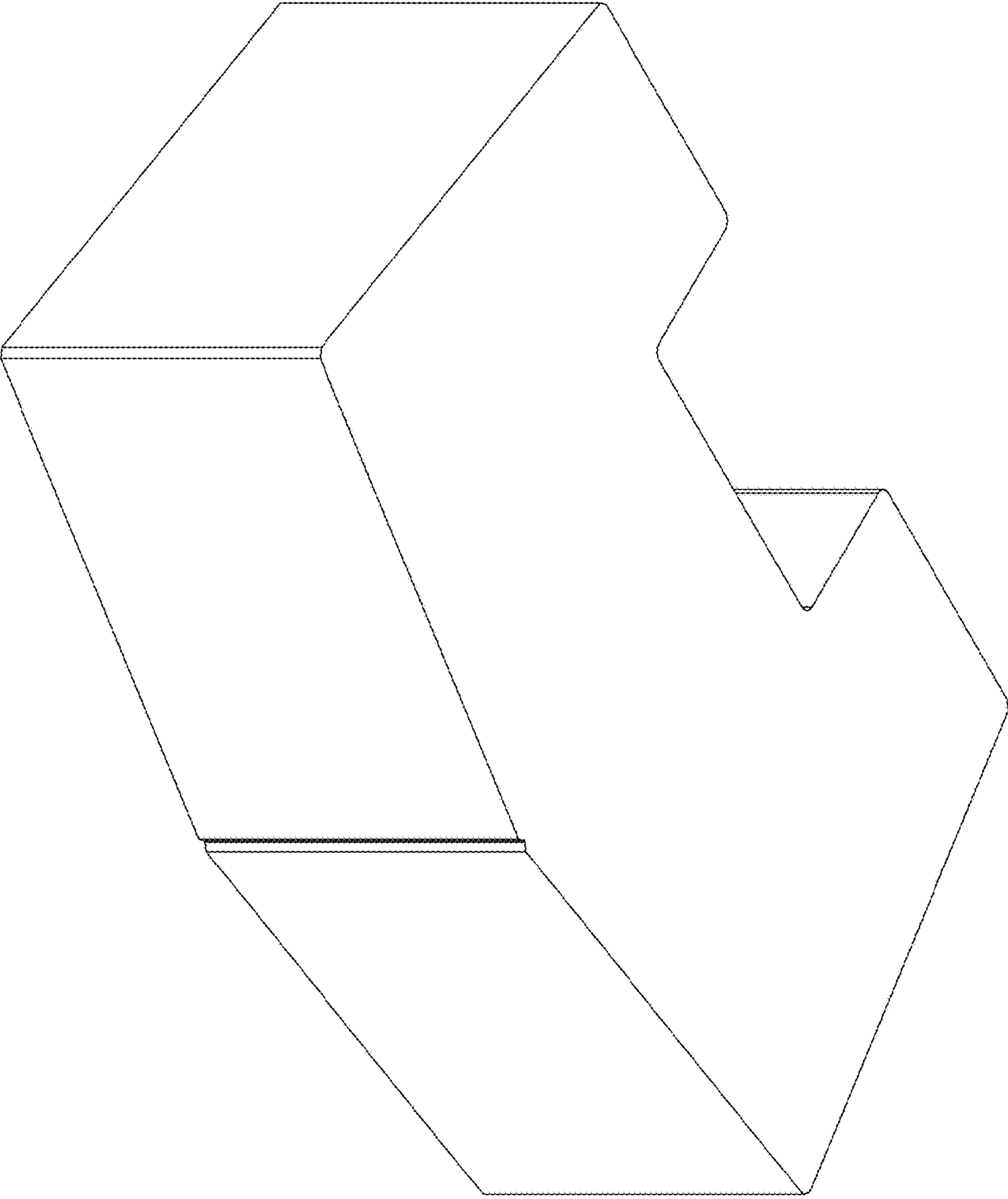

FIG. 8

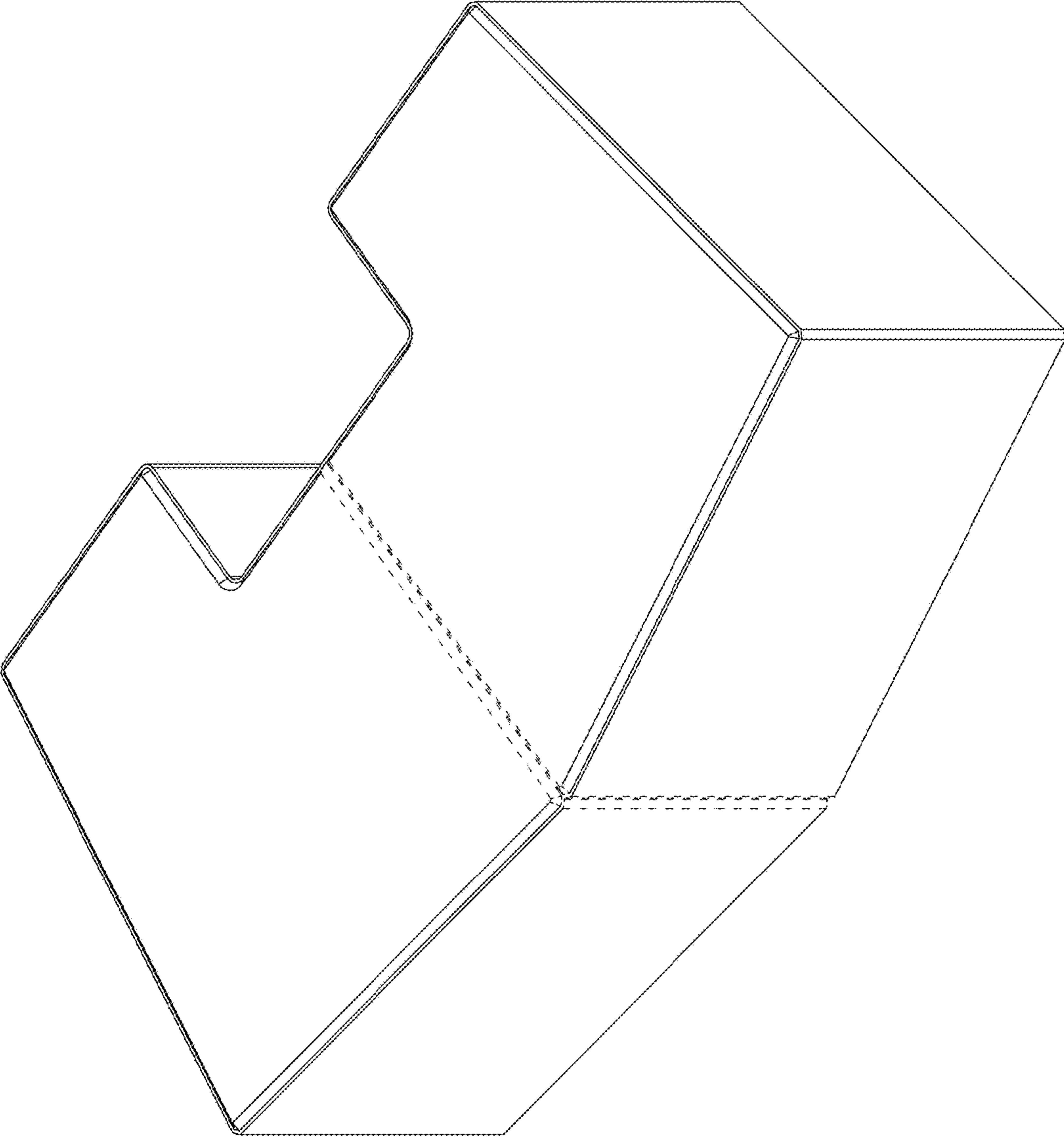

FIG. 9

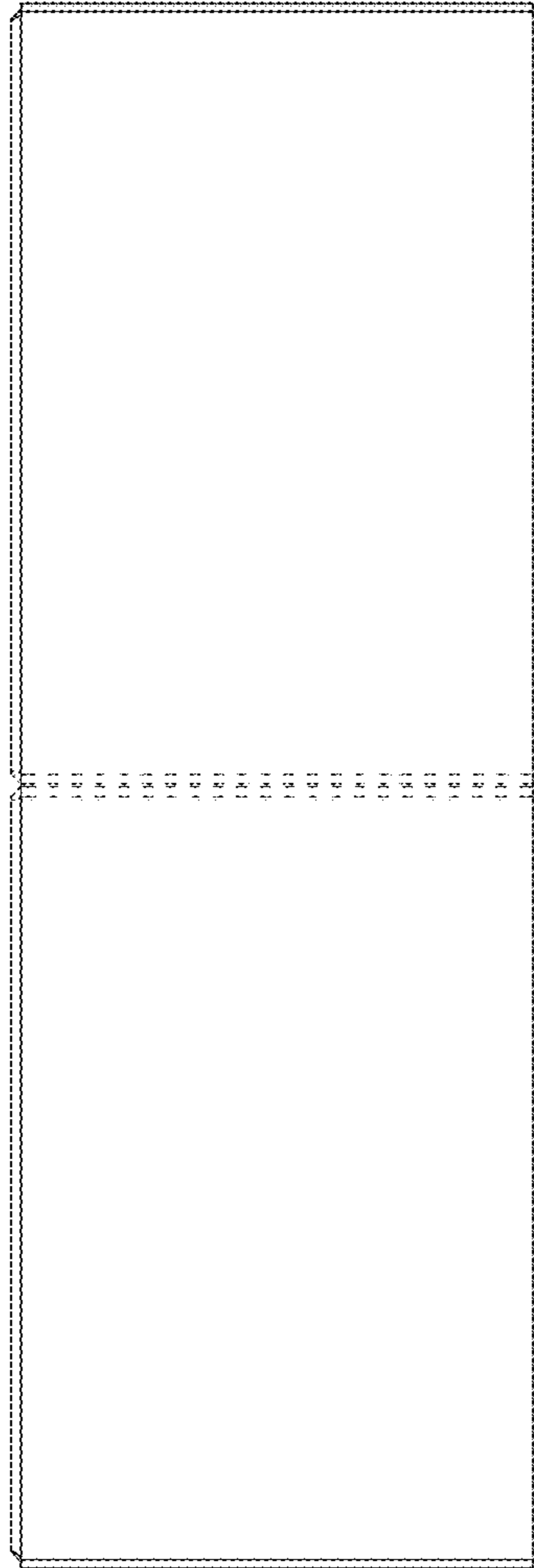

FIG. 10

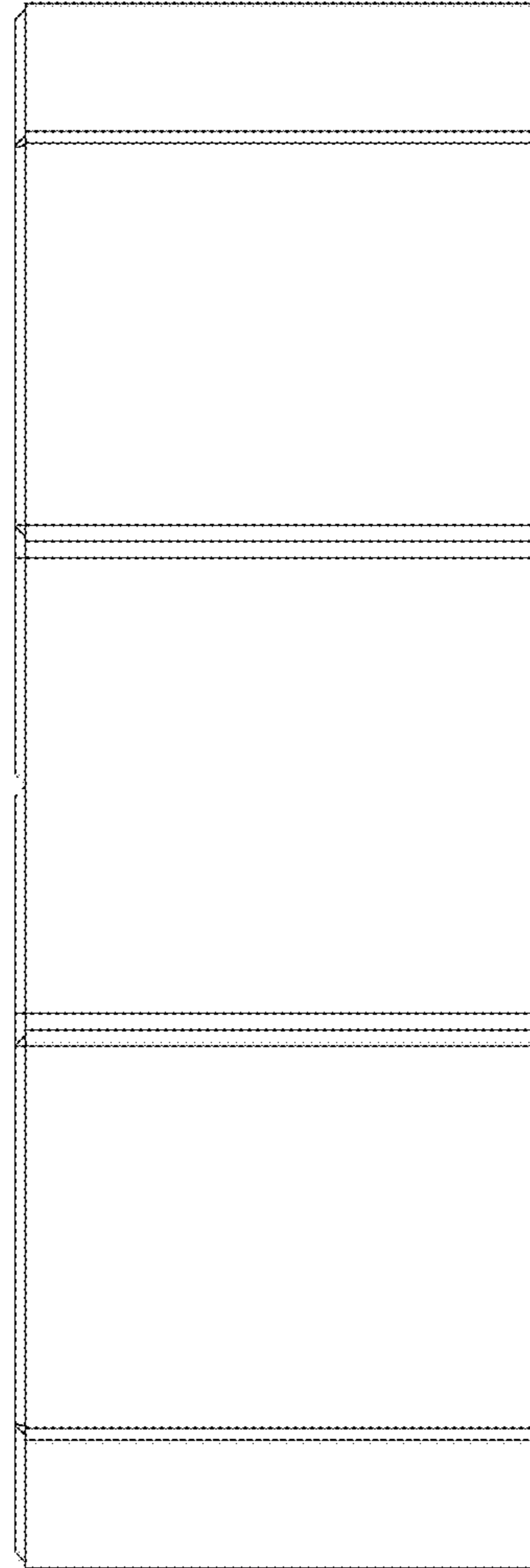

FIG. 11

FIG. 12

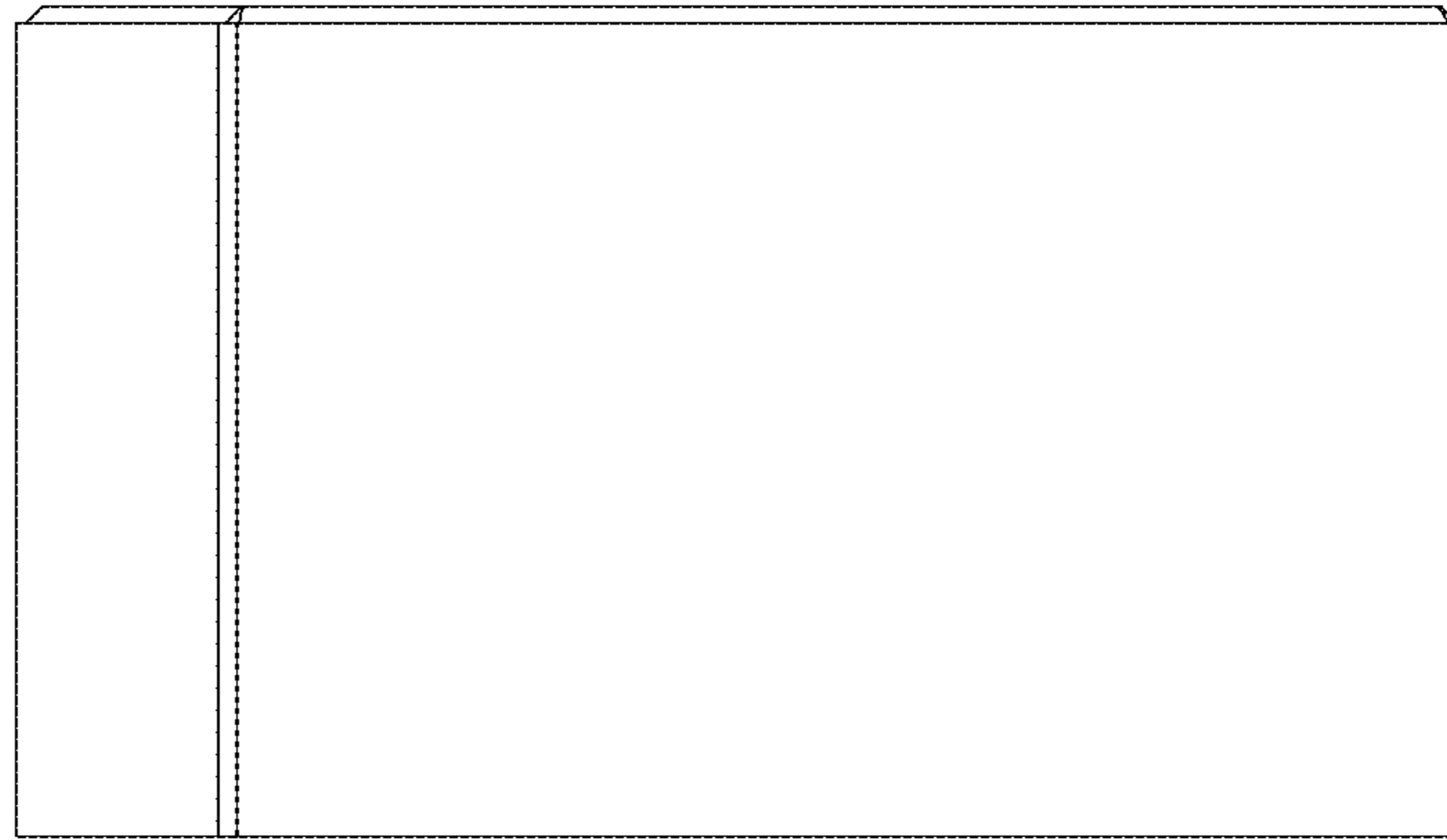
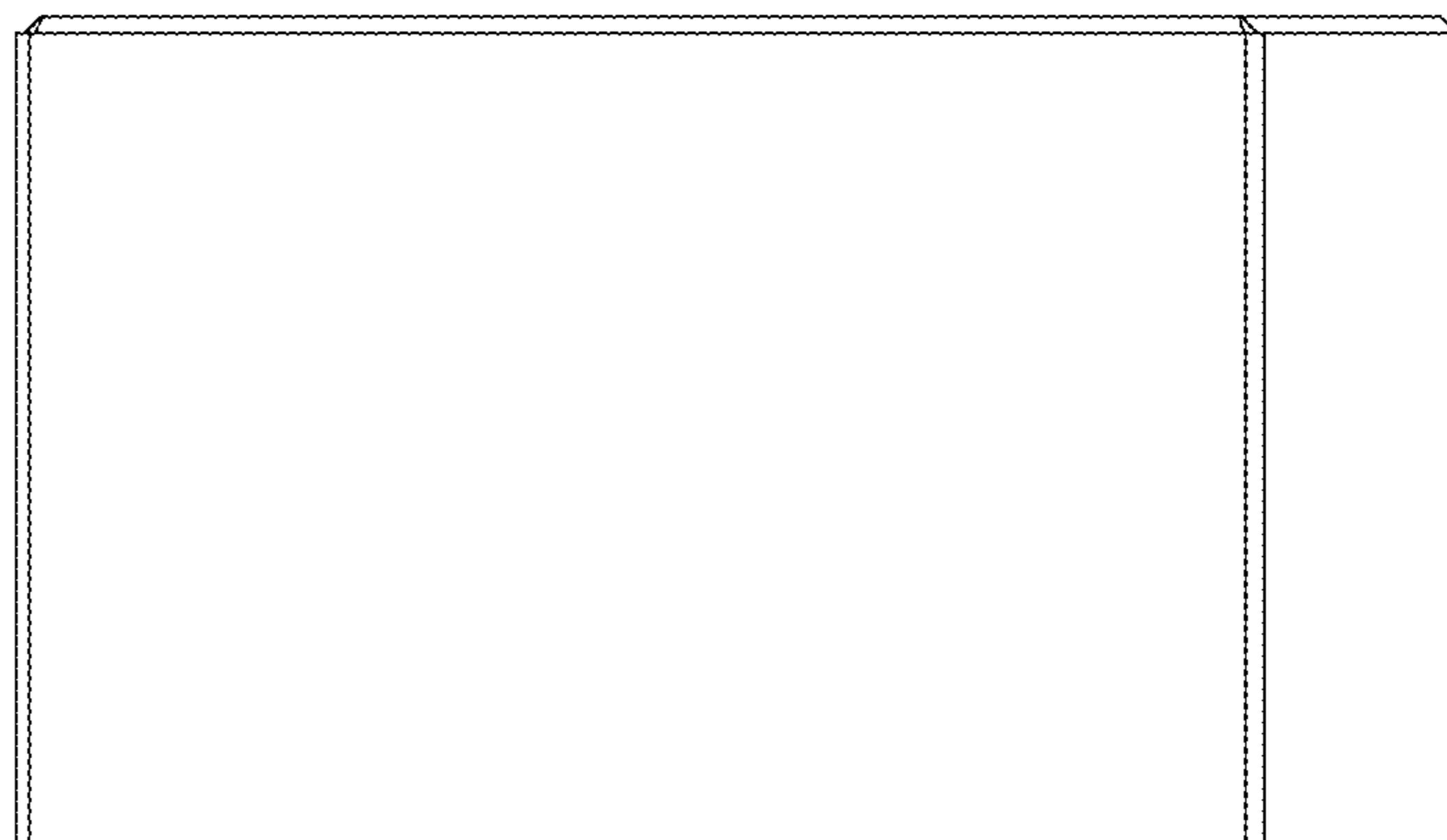

FIG. 13



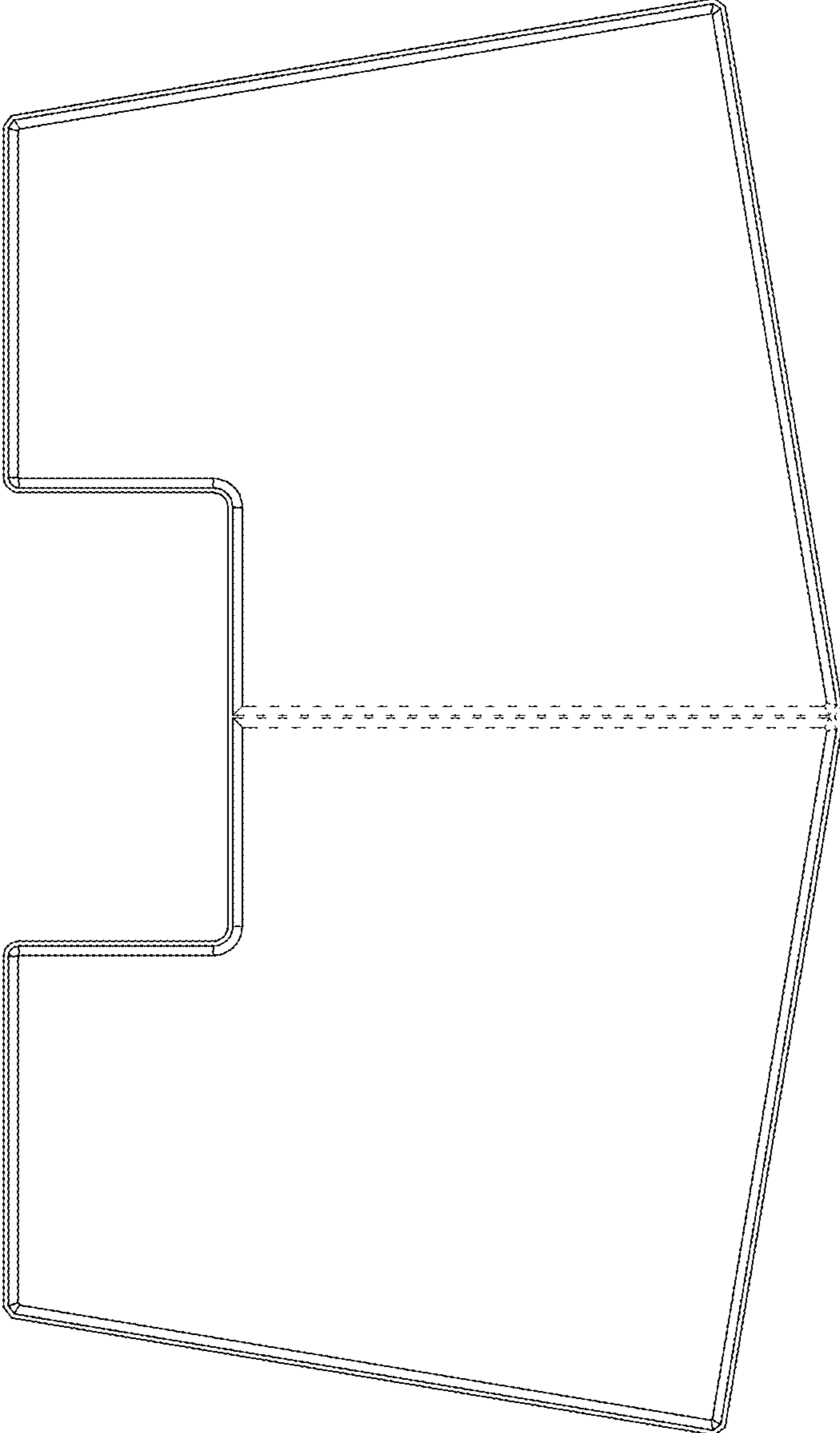

FIG. 14

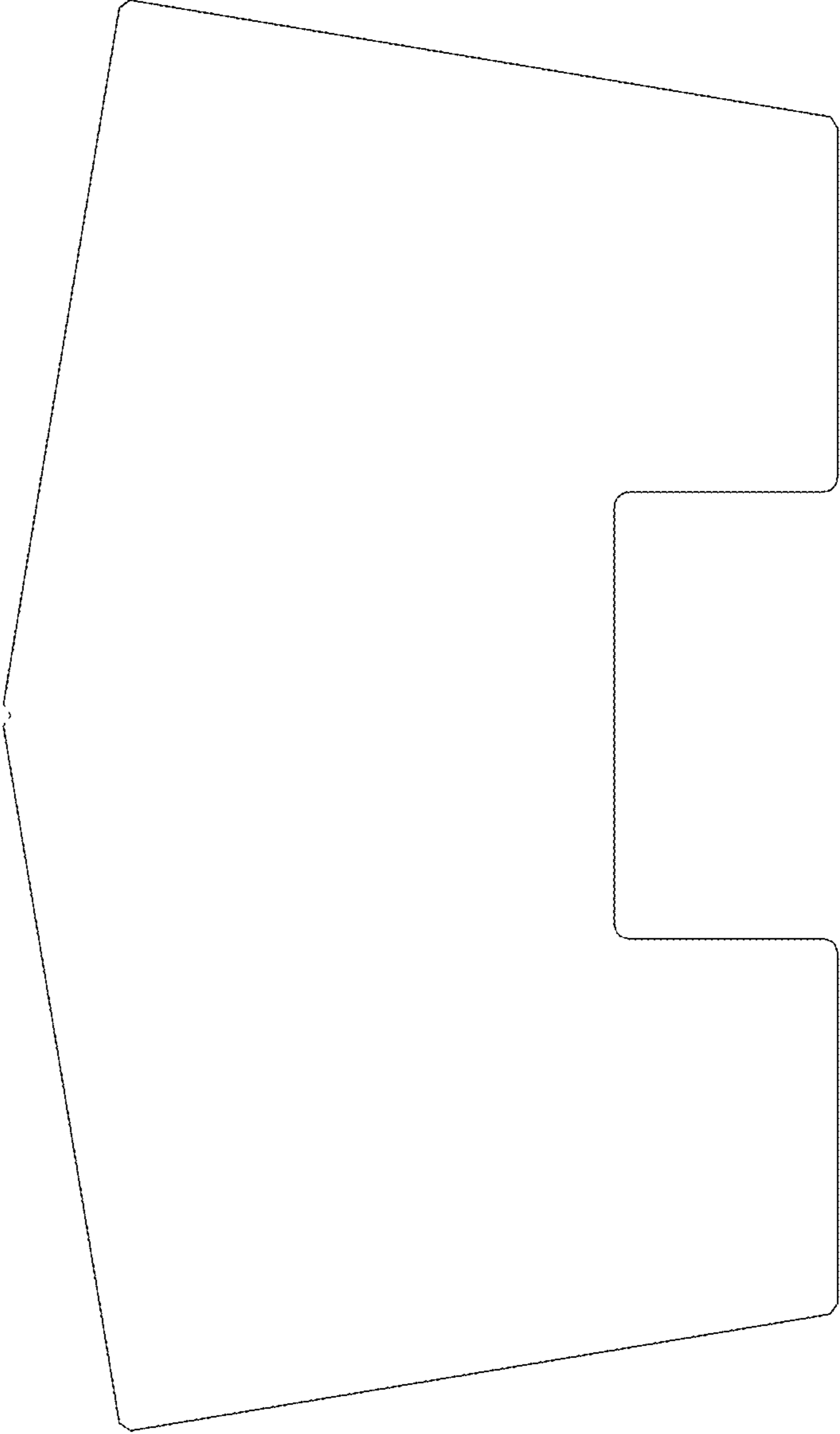

FIG. 15

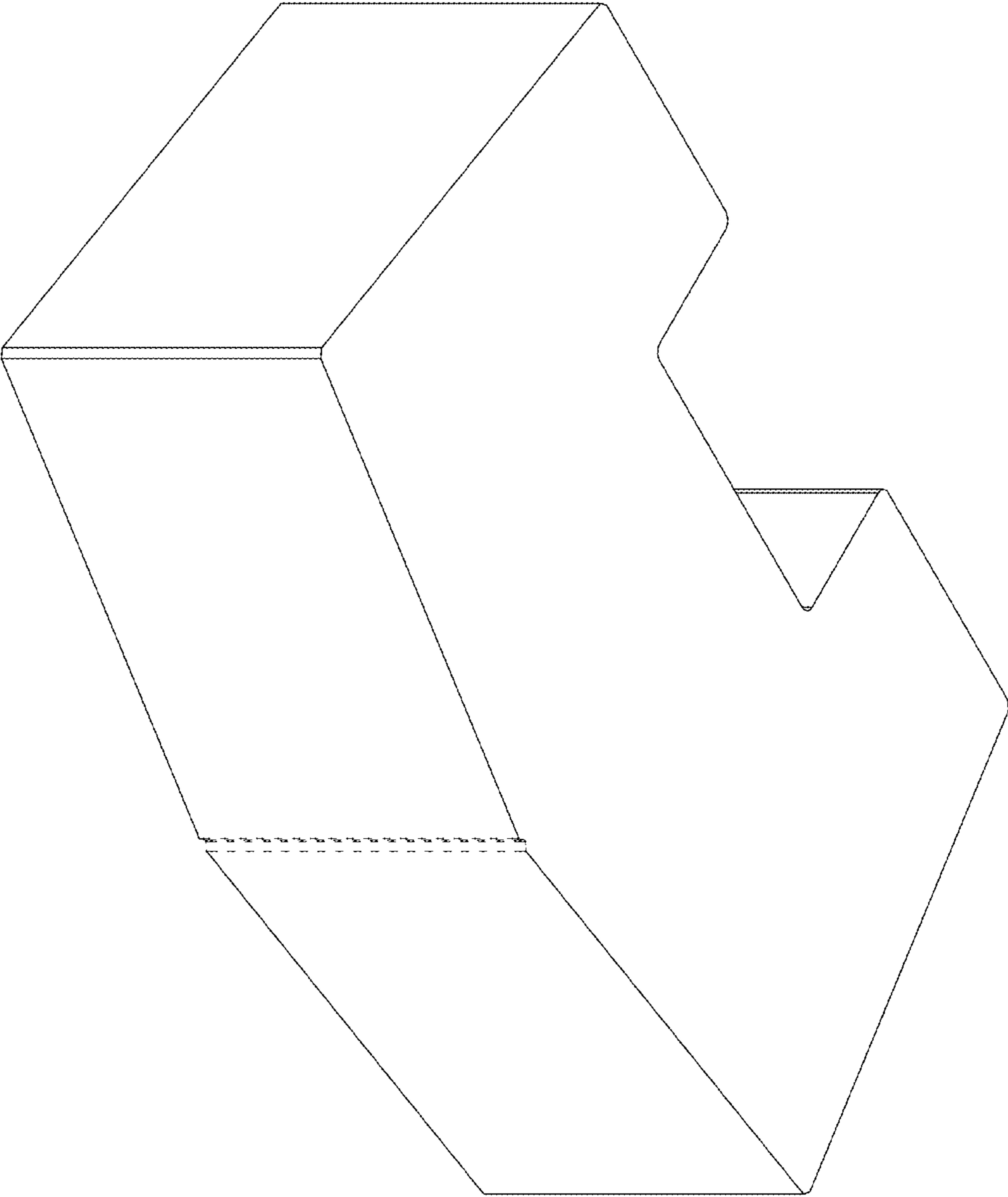

FIG. 16