



US00D829768S

(12) **United States Design Patent** (10) **Patent No.:** **US D829,768 S**  
**Lippitt et al.** (45) **Date of Patent:** **\*\* Oct. 2, 2018**

(54) **AUDIO NETWORK INTERFACE DEVICE**

(71) Applicant: **Bose Corporation**, Framingham, MA (US)

(72) Inventors: **Benjamin C. Lippitt**, Worcester, MA (US); **Robert A. Warden**, Southborough, MA (US)

(73) Assignee: **Bose Corporation**, Framingham, MA (US)

(\*\*) Term: **15 Years**

(21) Appl. No.: **29/592,579**

(22) Filed: **Jan. 31, 2017**

(51) **LOC (11) Cl.** ..... **14-03**

(52) **U.S. Cl.**  
USPC ..... **D14/496**; D14/188; D14/240; D14/358

(58) **Field of Classification Search**  
USPC ..... D14/125, 129, 130, 140, 142, 155, 167, D14/168, 172, 188, 195, 203.1, 203.6,  
(Continued)

(56) **References Cited**

U.S. PATENT DOCUMENTS

D348,070 S \* 6/1994 Vallillee ..... D14/240  
D419,988 S \* 2/2000 Brunner ..... D14/125  
(Continued)

*Primary Examiner* — Susan Bennett Hattan

*Assistant Examiner* — Marie D. Fast Horse

(74) *Attorney, Agent, or Firm* — Bose Corporation

(57) **CLAIM**

The ornamental design for an audio network interface device, substantially as shown and described.

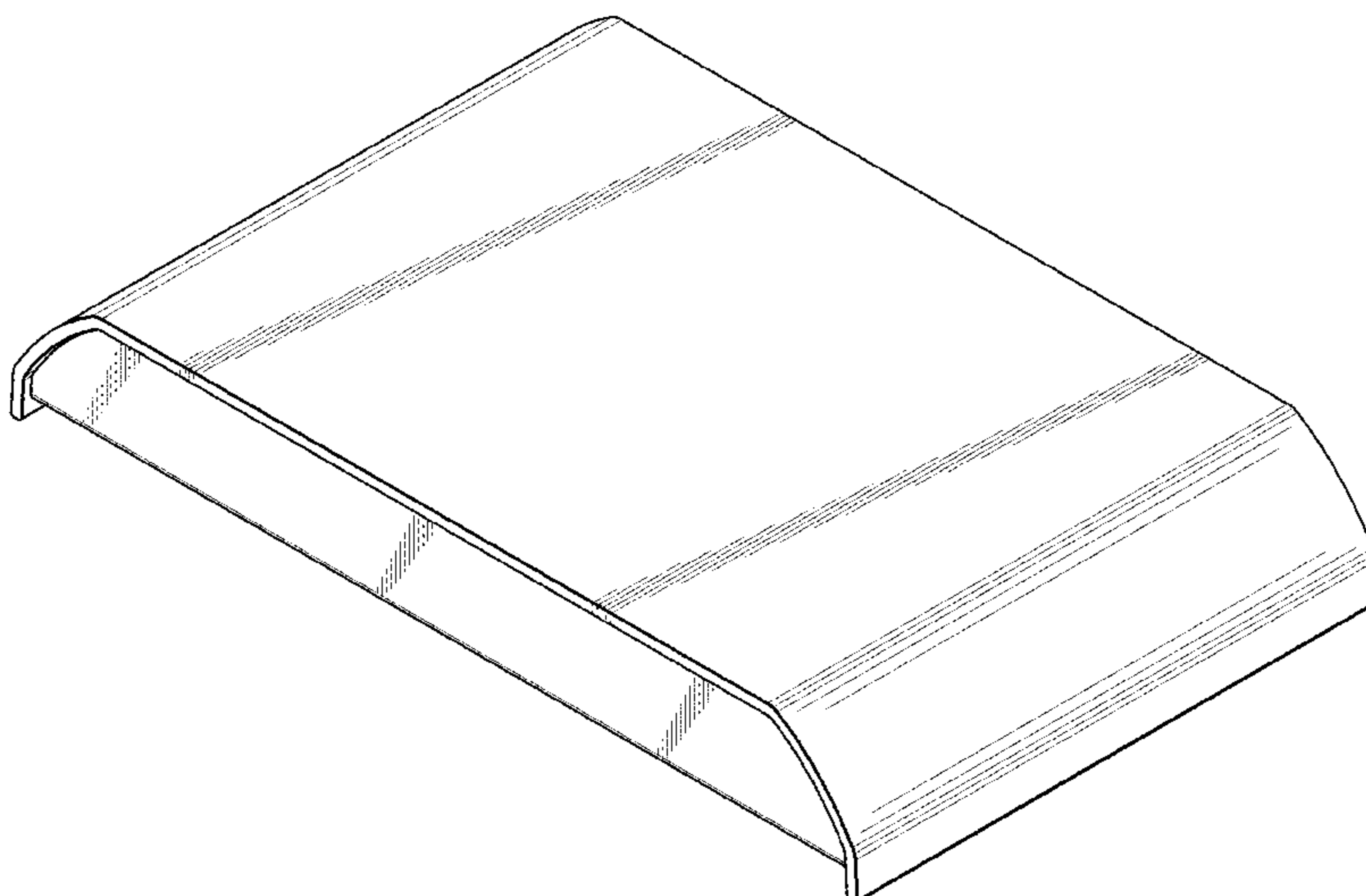
**DESCRIPTION**

FIG. 1 is a perspective view of a first embodiment of an audio network interface device as seen from the front, top, and right side;

FIG. 2 is top view thereof;  
FIG. 3 is a bottom view thereof;  
FIG. 4 is a front view thereof;  
FIG. 5 is a rear view thereof;  
FIG. 6 is a left side view thereof;  
FIG. 7 is a right side view thereof;  
FIG. 8 is a perspective view of a second embodiment of an audio network interface device as seen from the front, top, and right side;  
FIG. 9 is top view thereof;  
FIG. 10 is a bottom view thereof;  
FIG. 11 is a front view thereof;  
FIG. 12 is a rear view thereof;  
FIG. 13 is a left side view thereof;  
FIG. 14 is a right side view thereof;  
FIG. 15 is a perspective view of a third embodiment of an audio network interface device as seen from the front, top, and right side;  
FIG. 16 is top view thereof;  
FIG. 17 is a bottom view thereof;  
FIG. 18 is a front view thereof;  
FIG. 19 is a rear view thereof;  
FIG. 20 is a left side view thereof;  
FIG. 21 is a right side view thereof;  
FIG. 22 is a perspective view of a fourth embodiment of an audio network interface device as seen from the front, top, and right side;  
FIG. 23 is top view thereof;  
FIG. 24 is a bottom view thereof;  
FIG. 25 is a front view thereof;  
FIG. 26 is a rear view thereof;  
FIG. 27 is a left side view thereof; and,  
FIG. 28 is a right side view thereof.

The broken lines and unshaded surfaces shown in FIGS. 22, 23, 24, 27 and 28 depict a symbolic break in the length of the audio network interface device. The appearance of any unshaded portion of the audio network interface device in between the broken lines, including the broken lines themselves, forms no part of the claimed design.

**1 Claim, 20 Drawing Sheets**



(58) **Field of Classification Search**

USPC ..... D14/204, 205, 216, 240, 242, 299, 496,  
 D14/300, 302, 314, 348, 351, 388, 356,  
 D14/357, 358, 361, 362, 365, 367, 370,  
 D14/432, 433; D13/103, 107, 108, 123,  
 D13/152, 158, 162, 162.1, 163, 168, 184,  
 D13/199; D10/104.1, 106.1, 106.6,  
 D10/116.1, 61, 64, 75, 106.9  
 CPC . G06F 3/16; G06F 3/162; G06F 3/165; H04R  
 1/04; H04R 25/558; H04N 7/15  
 See application file for complete search history.

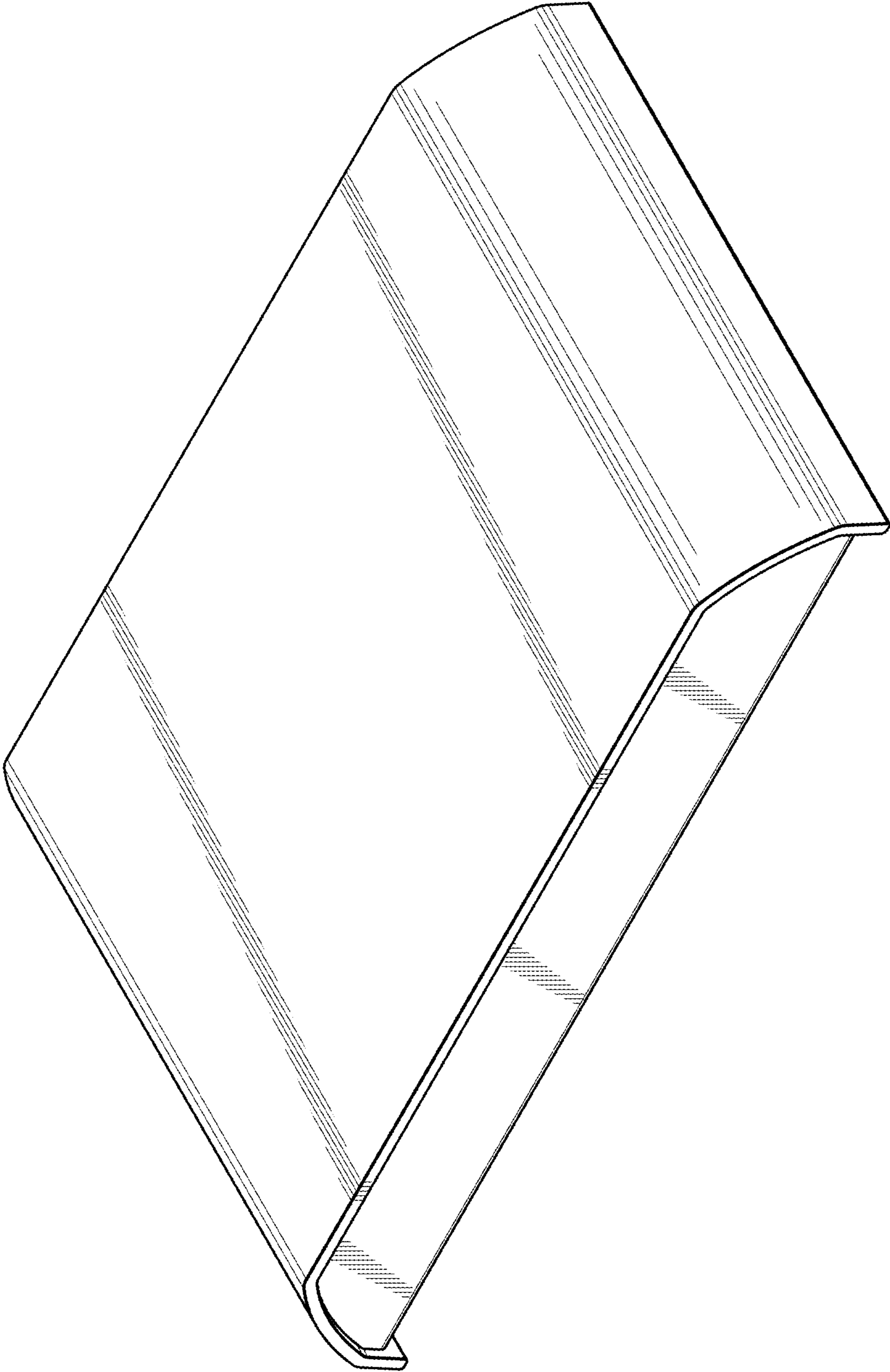
(56) **References Cited**

U.S. PATENT DOCUMENTS

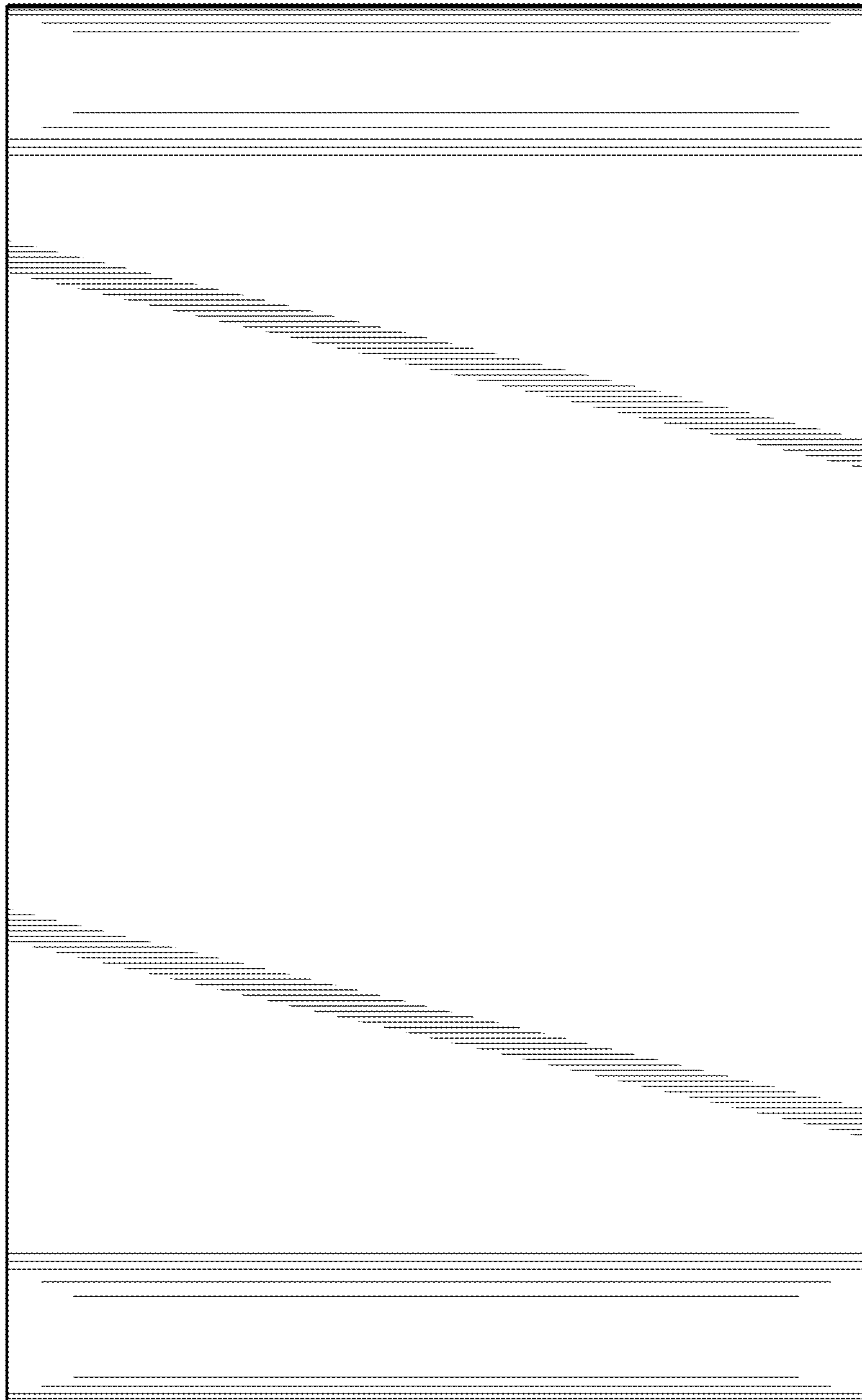
D441,374 S \* 5/2001 Genatossio ..... D14/496  
 D460,435 S \* 7/2002 Carbone ..... D14/188  
 D489,726 S \* 5/2004 Takita ..... D14/433  
 D508,531 S \* 8/2005 Hsu ..... D19/86  
 D534,545 S \* 1/2007 Leija ..... D14/496  
 D541,272 S \* 4/2007 Wang ..... D14/356  
 D545,768 S \* 7/2007 Hsu ..... D13/147  
 D556,199 S \* 11/2007 Song ..... D14/357  
 D558,786 S \* 1/2008 Green ..... D14/188  
 D562,264 S \* 2/2008 Jeong ..... D13/164  
 D563,334 S \* 3/2008 Wang ..... D14/125  
 D563,392 S \* 3/2008 Corsini ..... D14/496  
 D563,943 S \* 3/2008 Watanabe ..... D14/188  
 D571,788 S \* 6/2008 King, Jr. .... D14/217  
 D589,916 S \* 4/2009 Xie ..... D14/125  
 D626,099 S \* 10/2010 Huang ..... D14/125

D637,983 S \* 5/2011 Kim ..... D14/125  
 D642,565 S \* 8/2011 Demskie ..... D14/358  
 D642,625 S \* 8/2011 Assa ..... D21/329  
 D647,920 S \* 11/2011 Luo ..... D14/496  
 D654,496 S \* 2/2012 Chen ..... D14/314  
 D656,936 S \* 4/2012 Saunders ..... D14/240  
 D661,697 S \* 6/2012 Saunders ..... D14/240  
 D665,379 S \* 8/2012 Behringer ..... D14/193  
 D678,286 S \* 3/2013 Cheng ..... D14/433  
 D684,193 S \* 6/2013 Maier ..... D14/496  
 D704,184 S \* 5/2014 Chen ..... D14/308  
 D715,277 S \* 10/2014 Kim ..... D14/239  
 D723,504 S \* 3/2015 Reimer ..... D14/155  
 D724,057 S \* 3/2015 Kim ..... D14/217  
 D726,179 S \* 4/2015 Orthey ..... D14/358  
 D730,311 S \* 5/2015 Reimer ..... D14/155  
 D730,351 S \* 5/2015 Lee ..... D14/240  
 D733,136 S \* 6/2015 Morgan ..... D14/365  
 D734,290 S \* 7/2015 Reimer ..... D14/155  
 D738,347 S \* 9/2015 Reimer ..... D14/155  
 D740,828 S \* 10/2015 Bucsa ..... D14/433  
 D741,833 S \* 10/2015 Reimer ..... D14/155  
 D746,252 S \* 12/2015 Reimer ..... D14/155  
 D752,013 S \* 3/2016 Benedetti ..... D14/204  
 D763,112 S \* 8/2016 Choi ..... D10/108  
 D769,246 S \* 10/2016 Mielnik ..... D14/433  
 D776,112 S \* 1/2017 Bae ..... D14/374  
 D800,136 S \* 10/2017 Chen ..... D14/451  
 D804,534 S \* 12/2017 Gardner ..... D14/496  
 D809,566 S \* 2/2018 Gardner ..... D14/496  
 D810,043 S \* 2/2018 Suzuki ..... D14/188  
 D817,288 S \* 5/2018 Won ..... D14/125

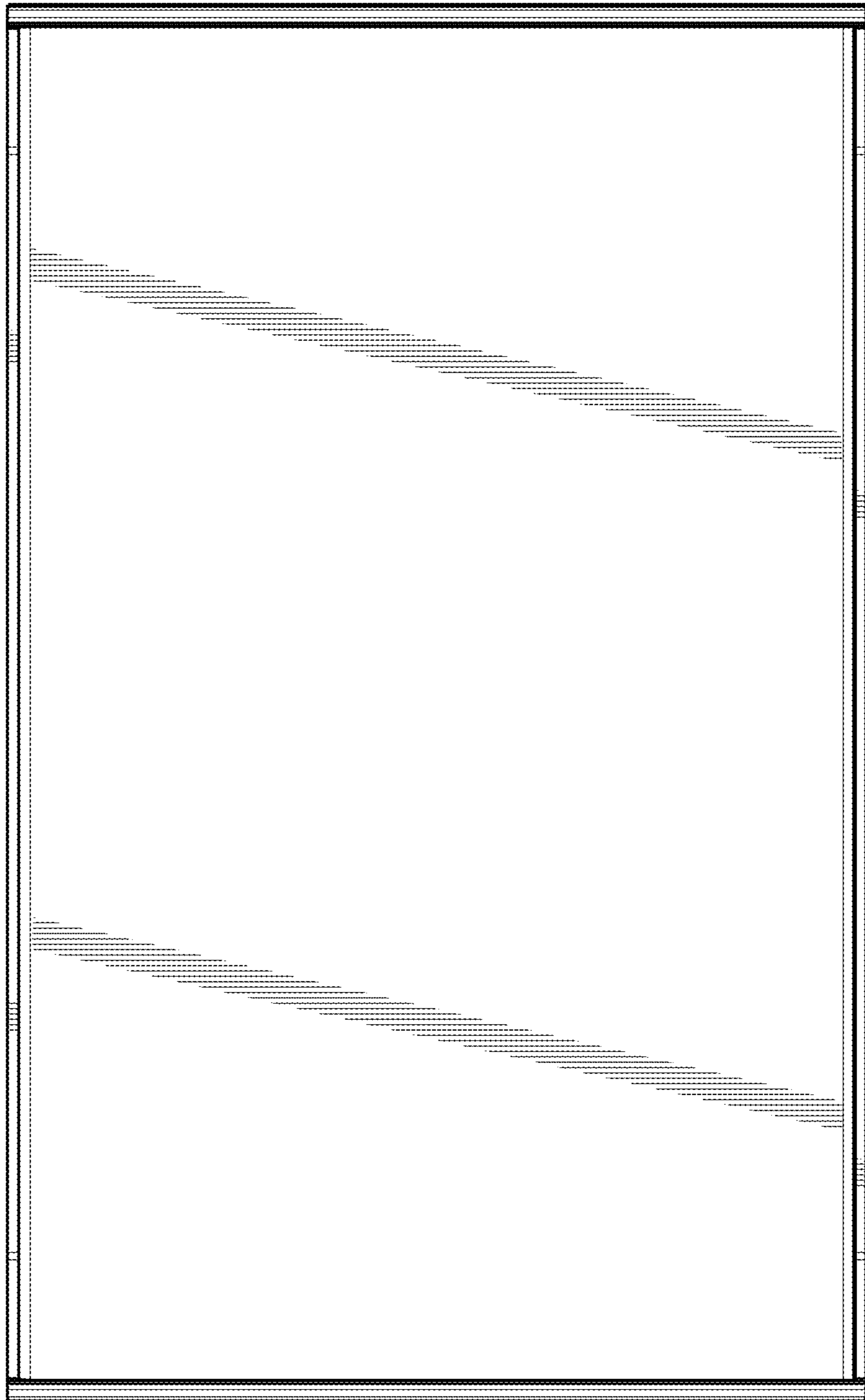
\* cited by examiner



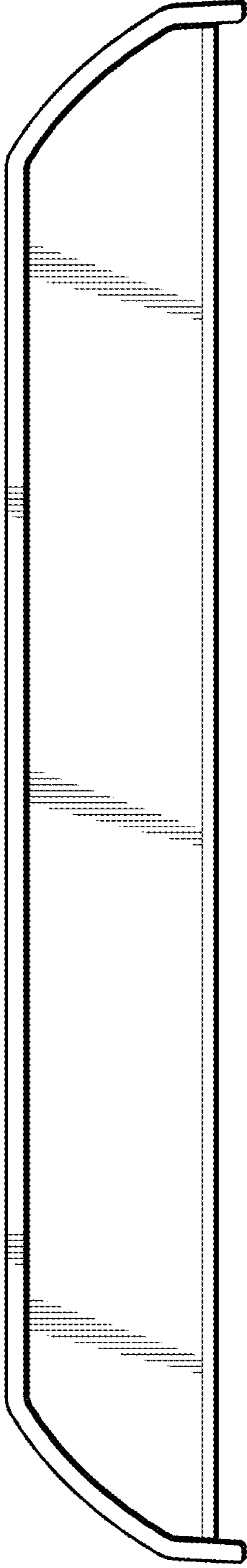
**FIG. 1**



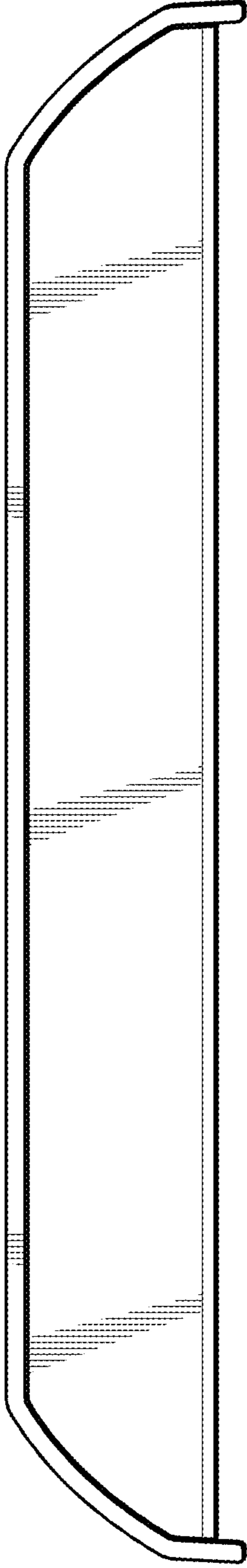
**FIG. 2**



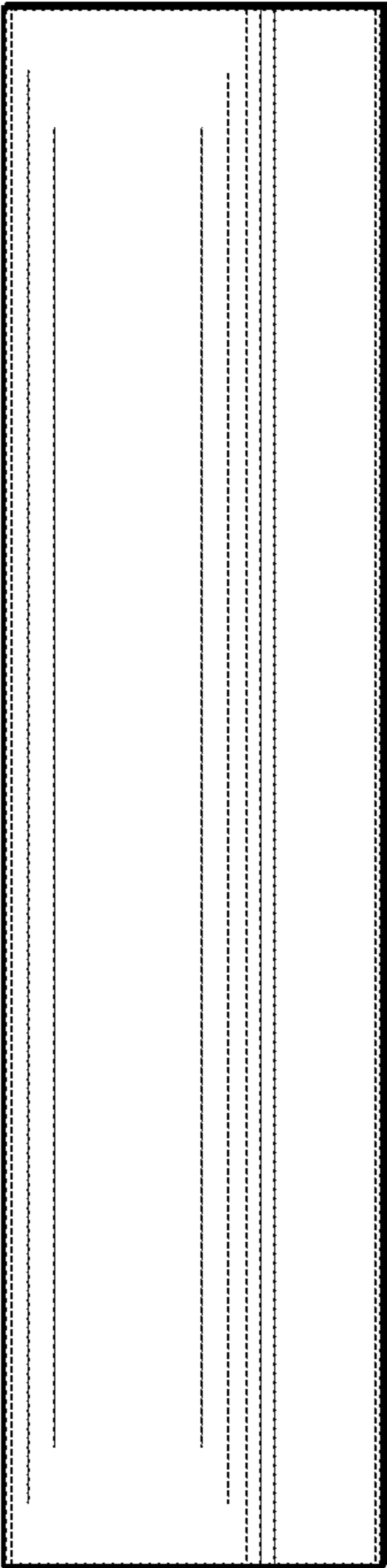
**FIG. 3**



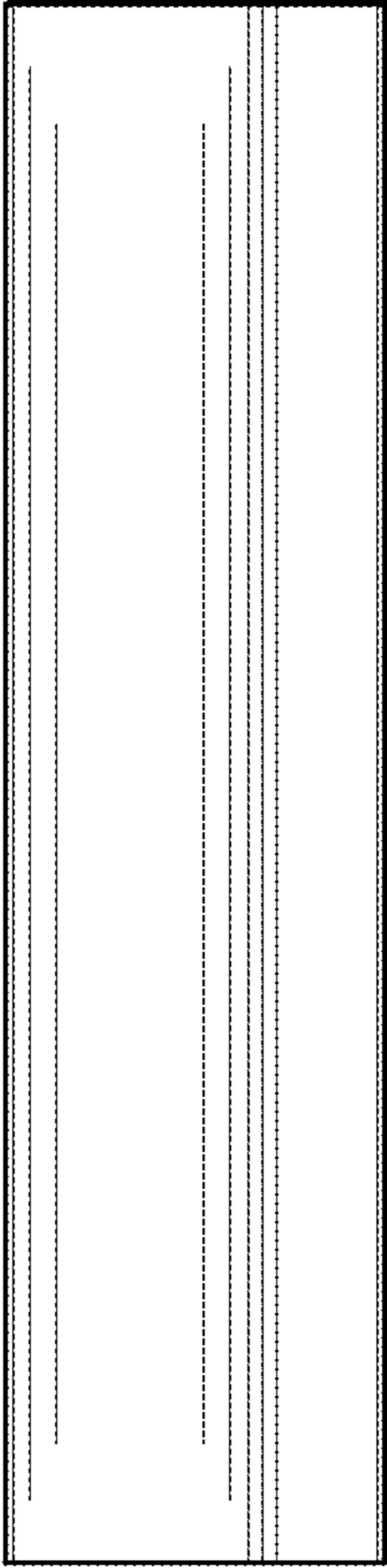
**FIG. 4**



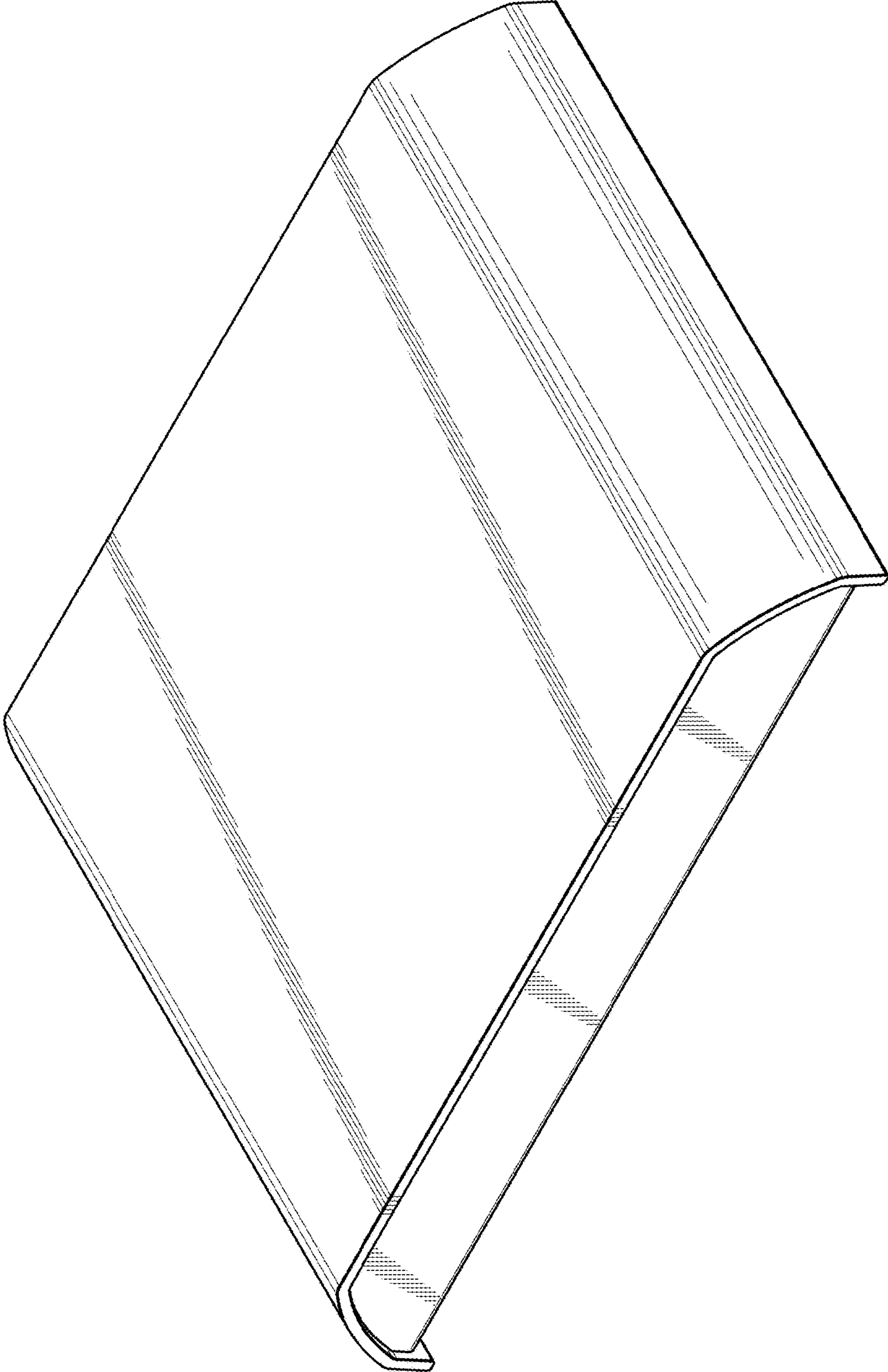
**FIG. 5**



**FIG. 6**

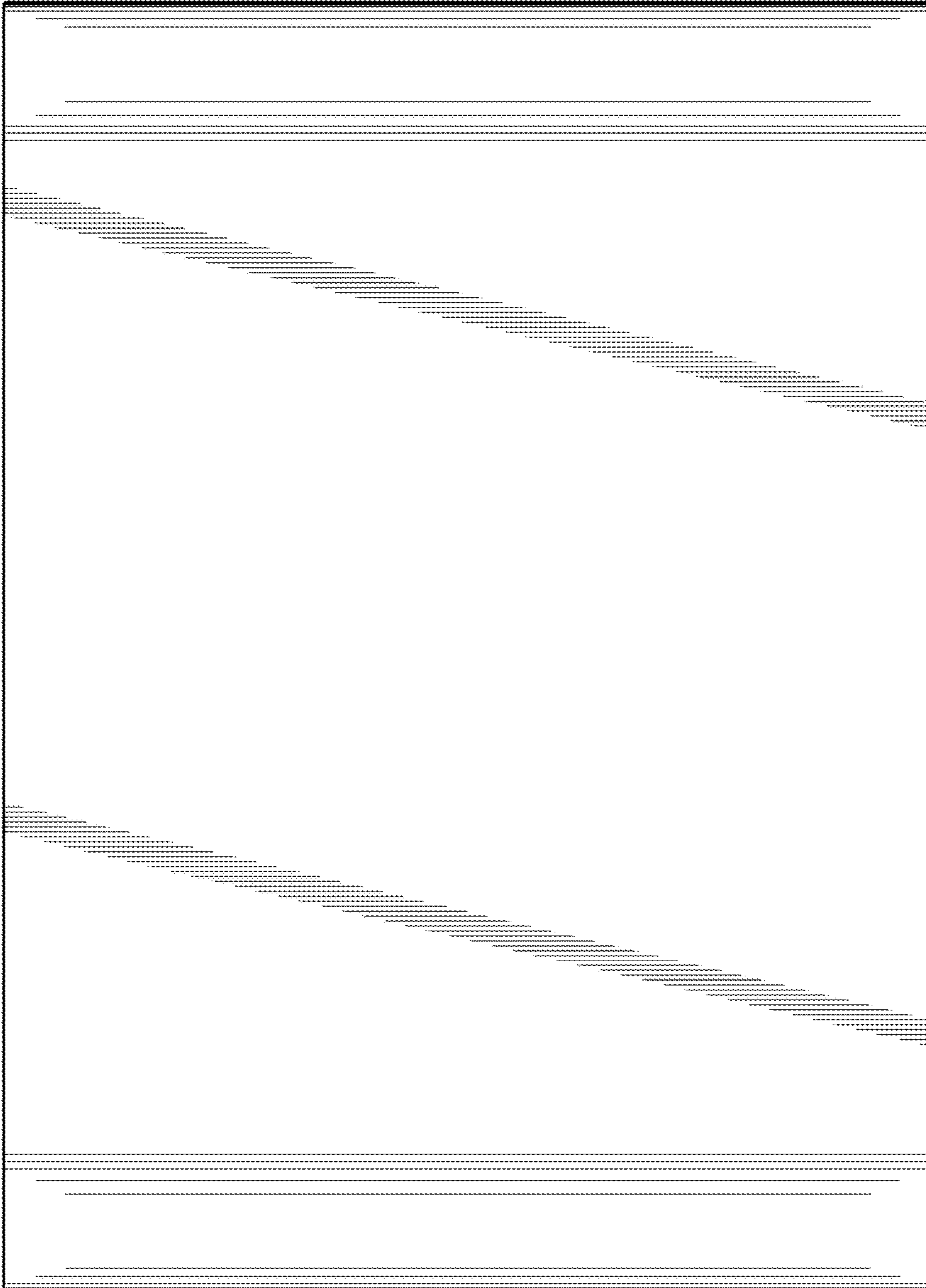


**FIG. 7**

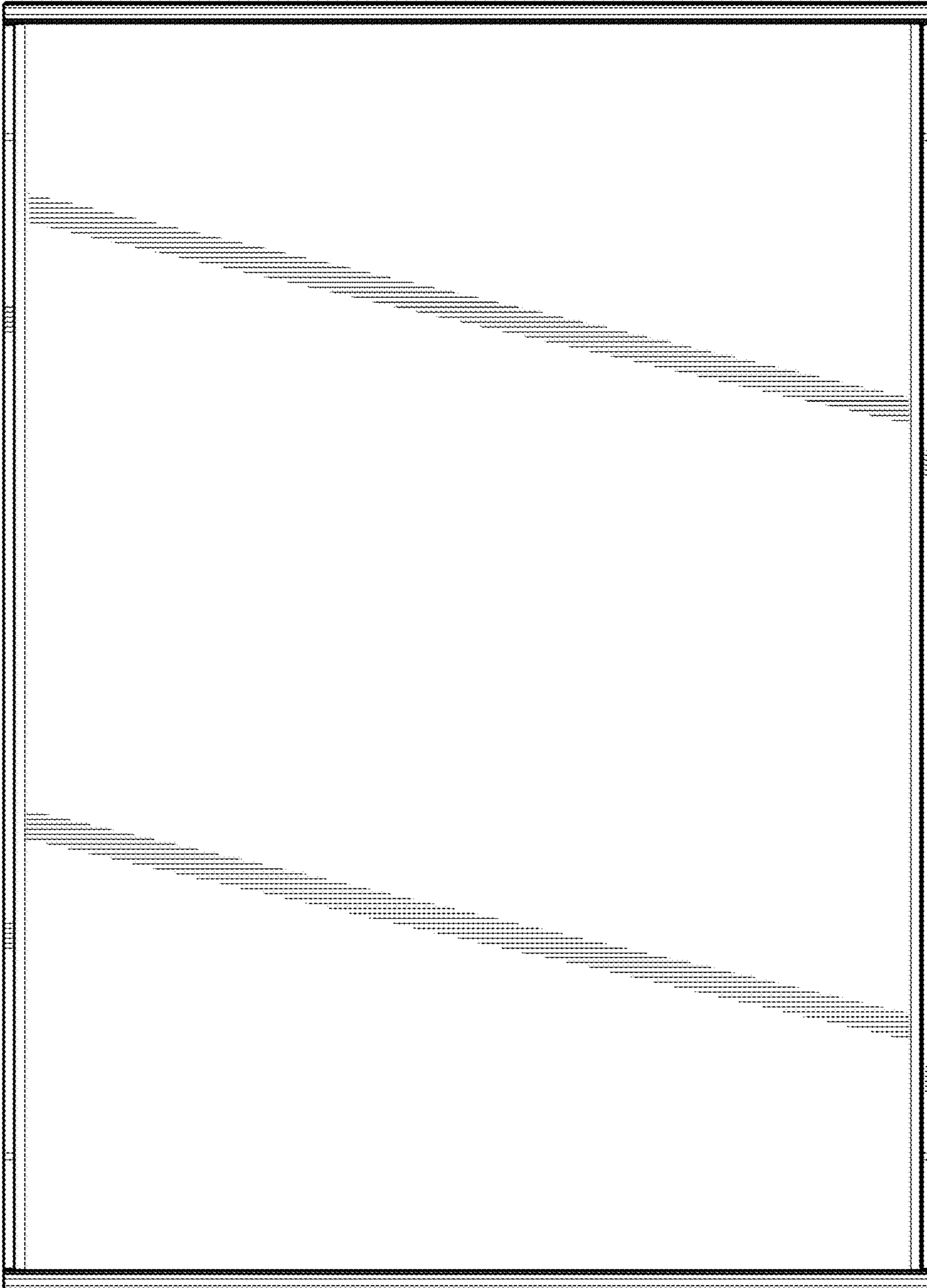


**FIG. 8**

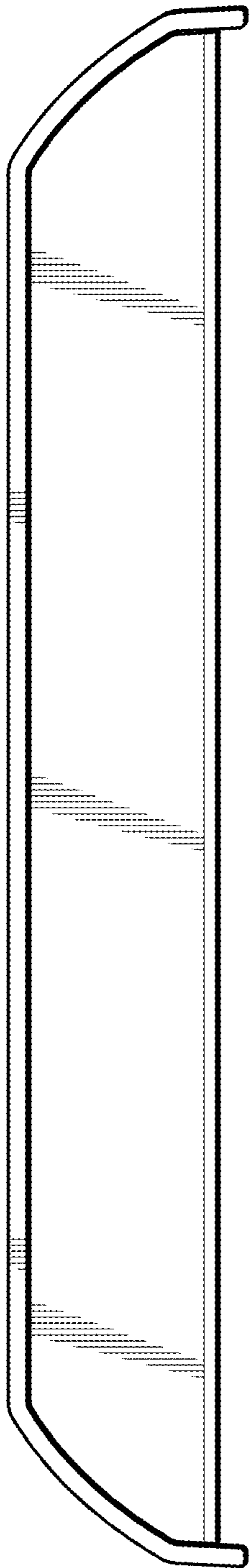




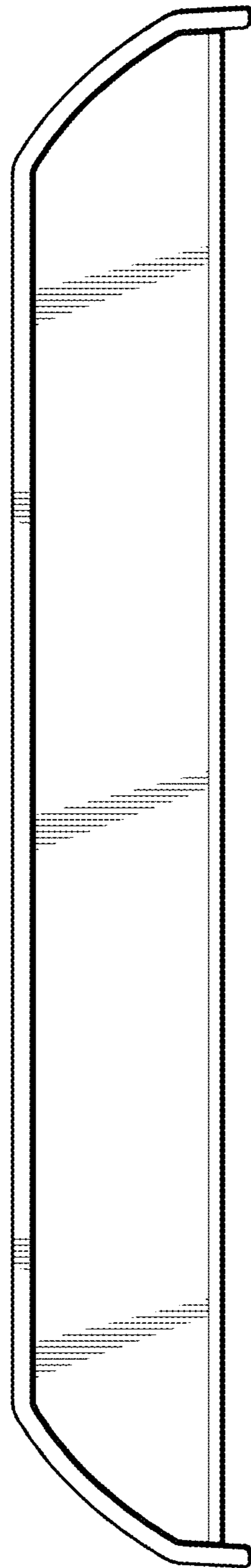
**FIG. 9**



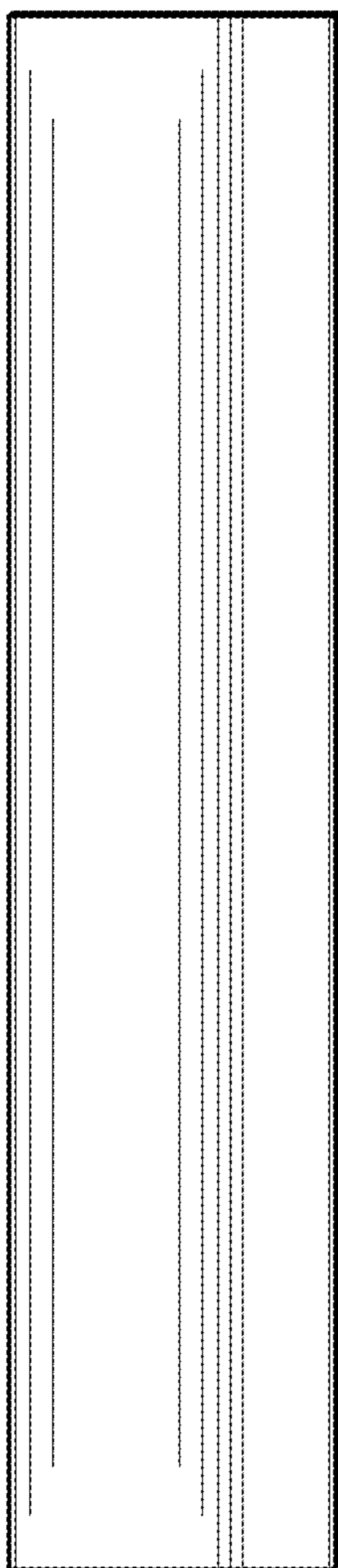
**FIG. 10**



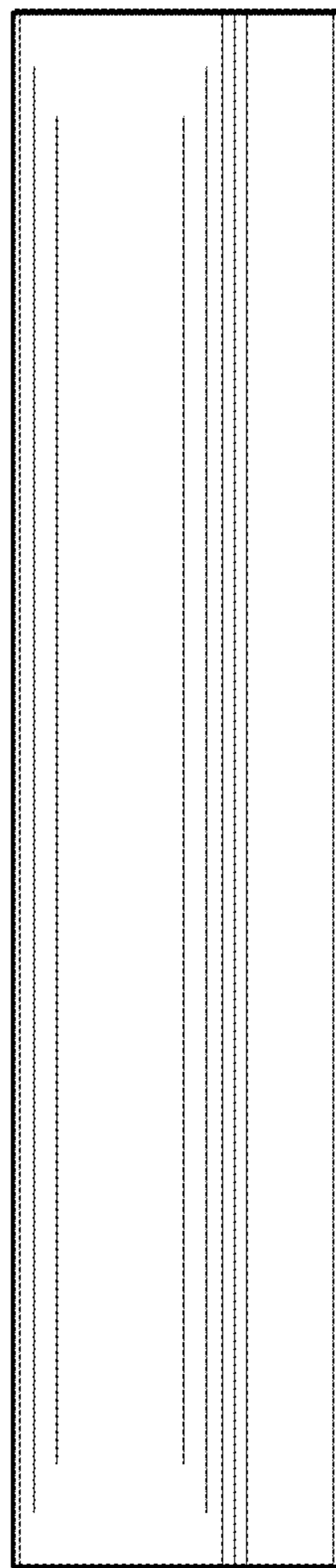
**FIG. 11**



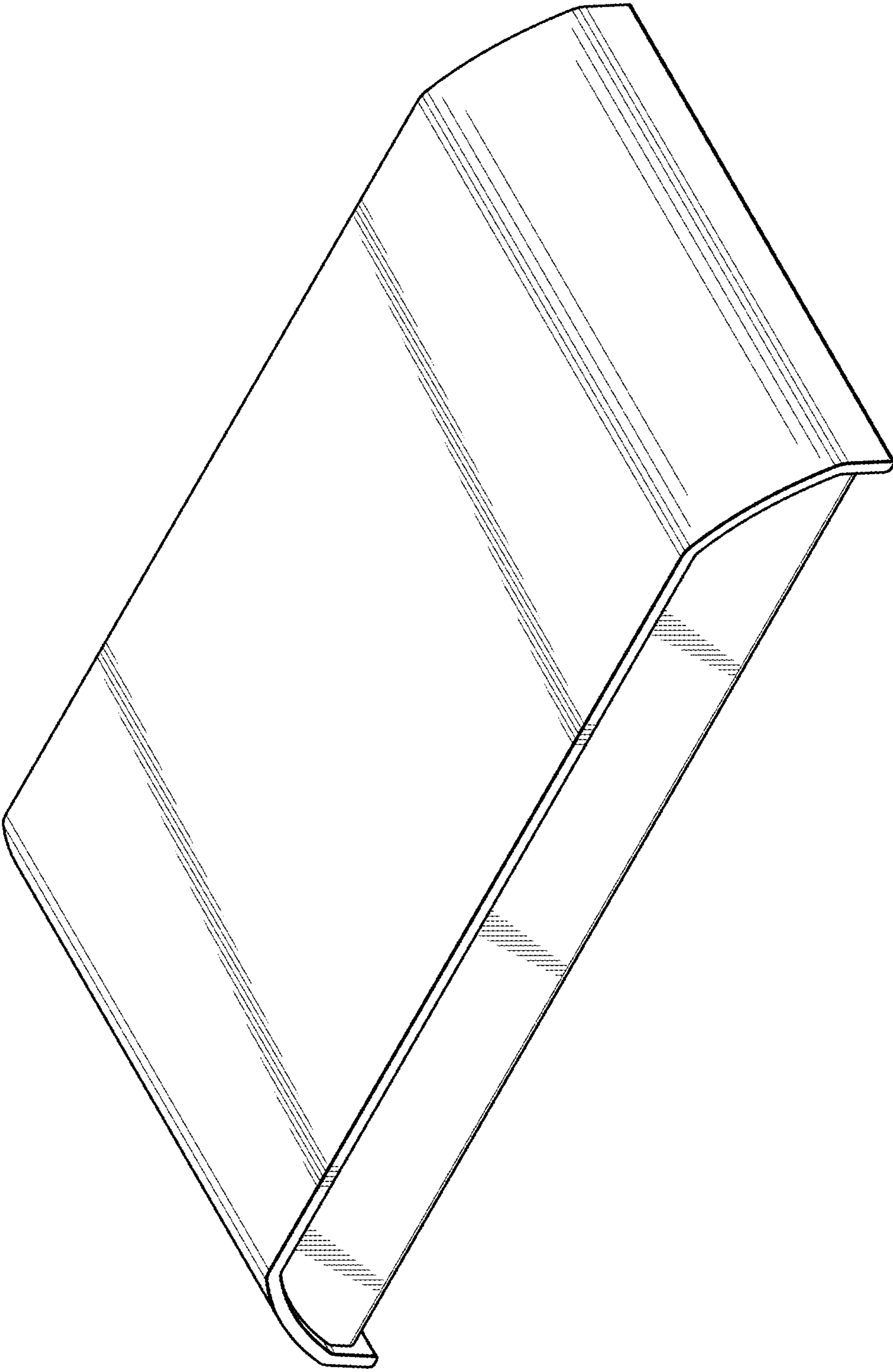
**FIG. 12**



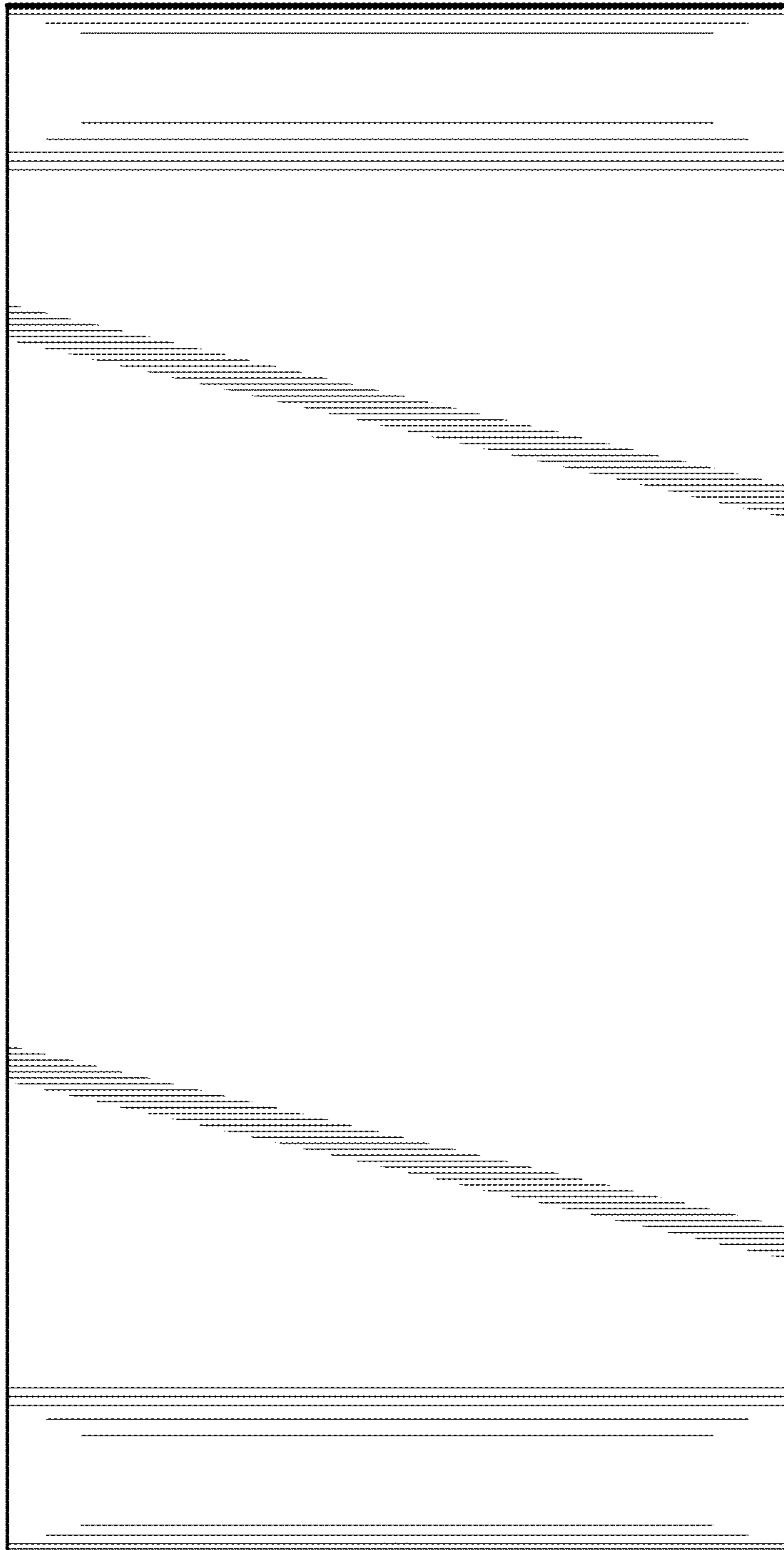
**FIG. 13**



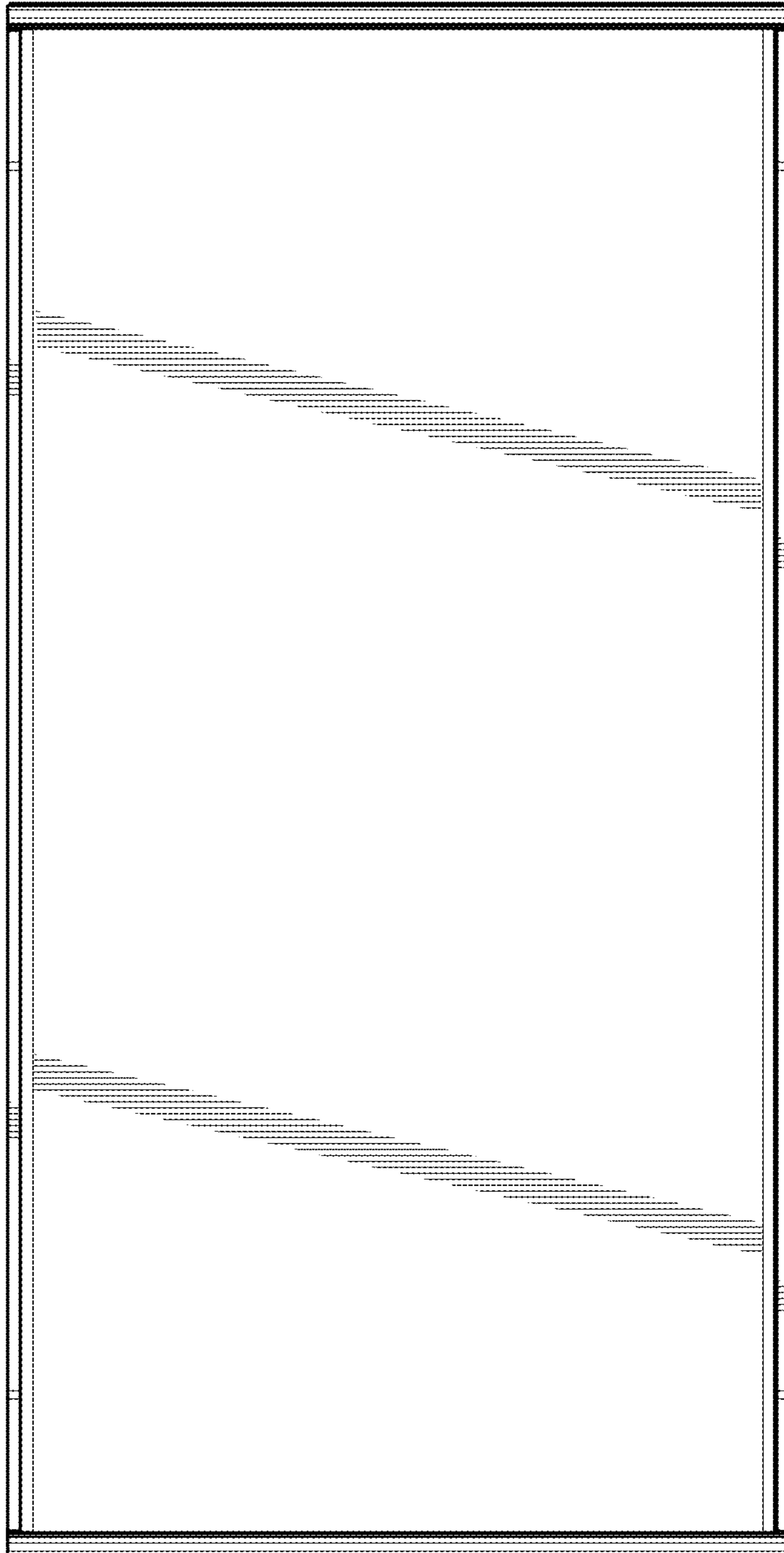
**FIG. 14**



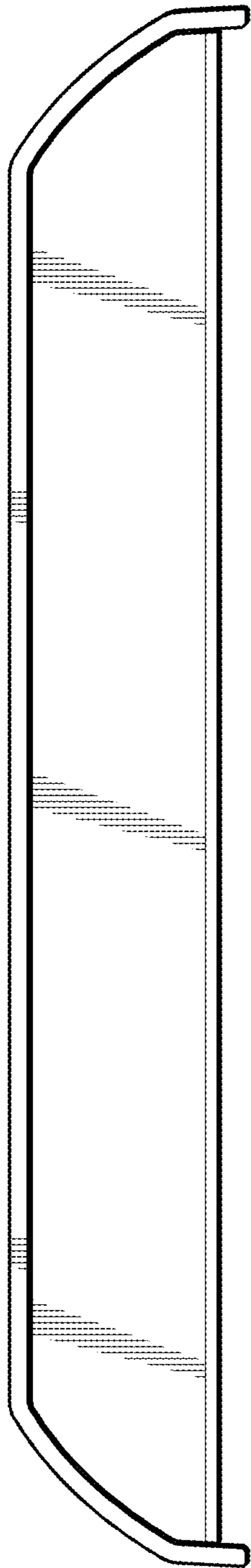
**FIG. 15**



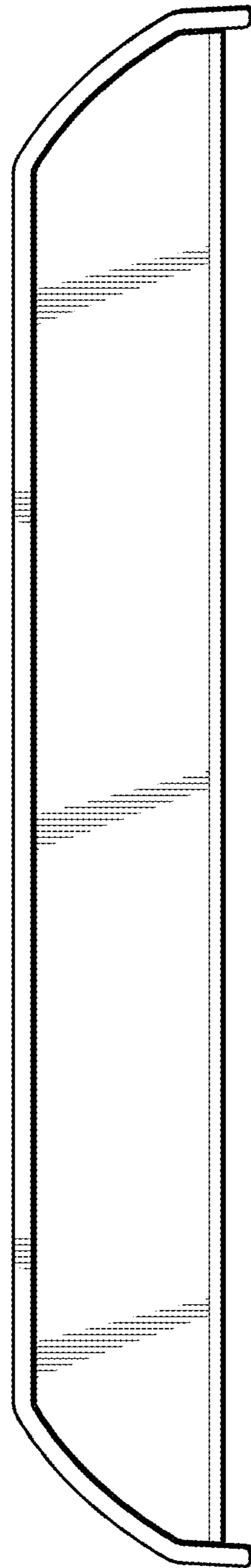
**FIG. 16**



**FIG. 17**

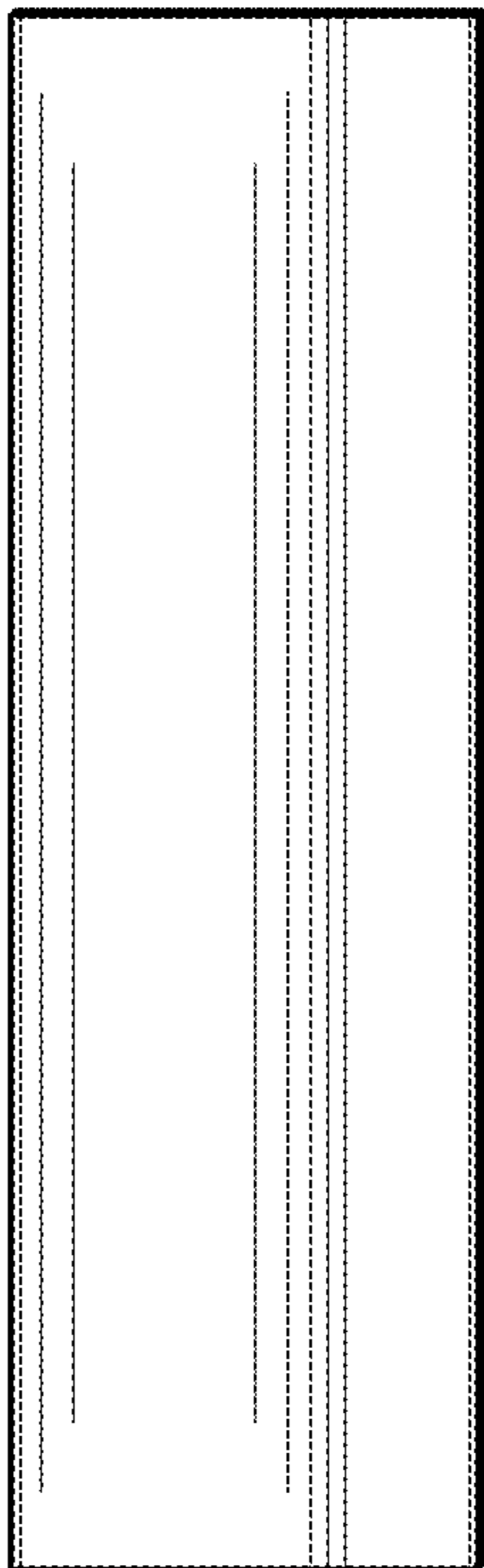


**FIG. 18**

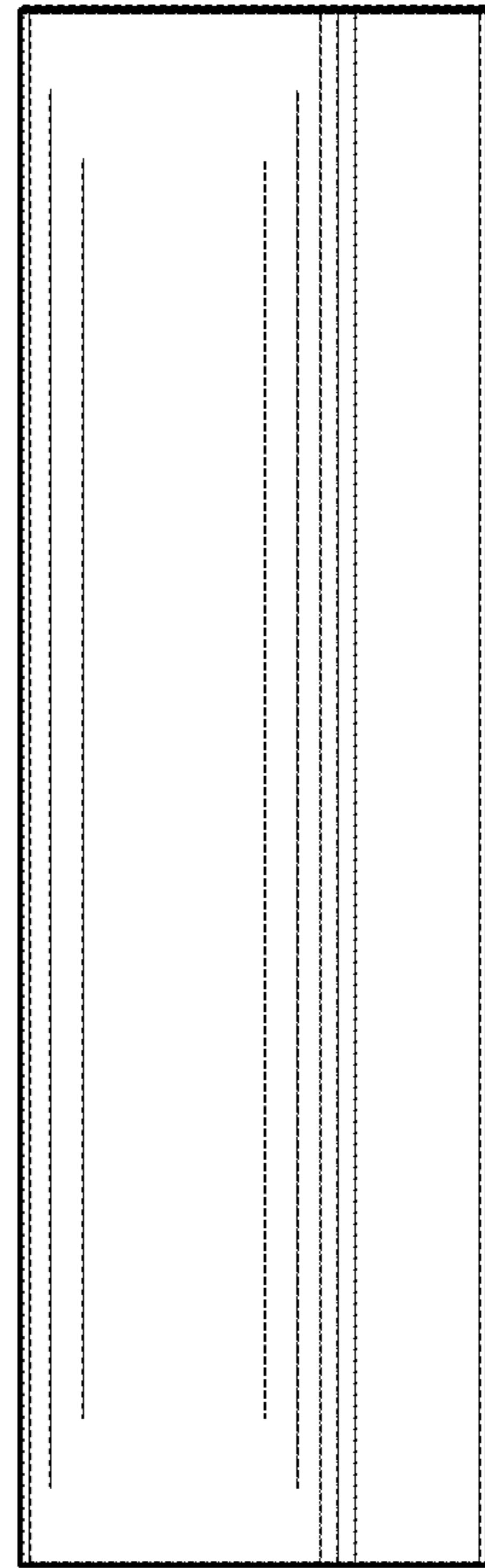


**FIG. 19**

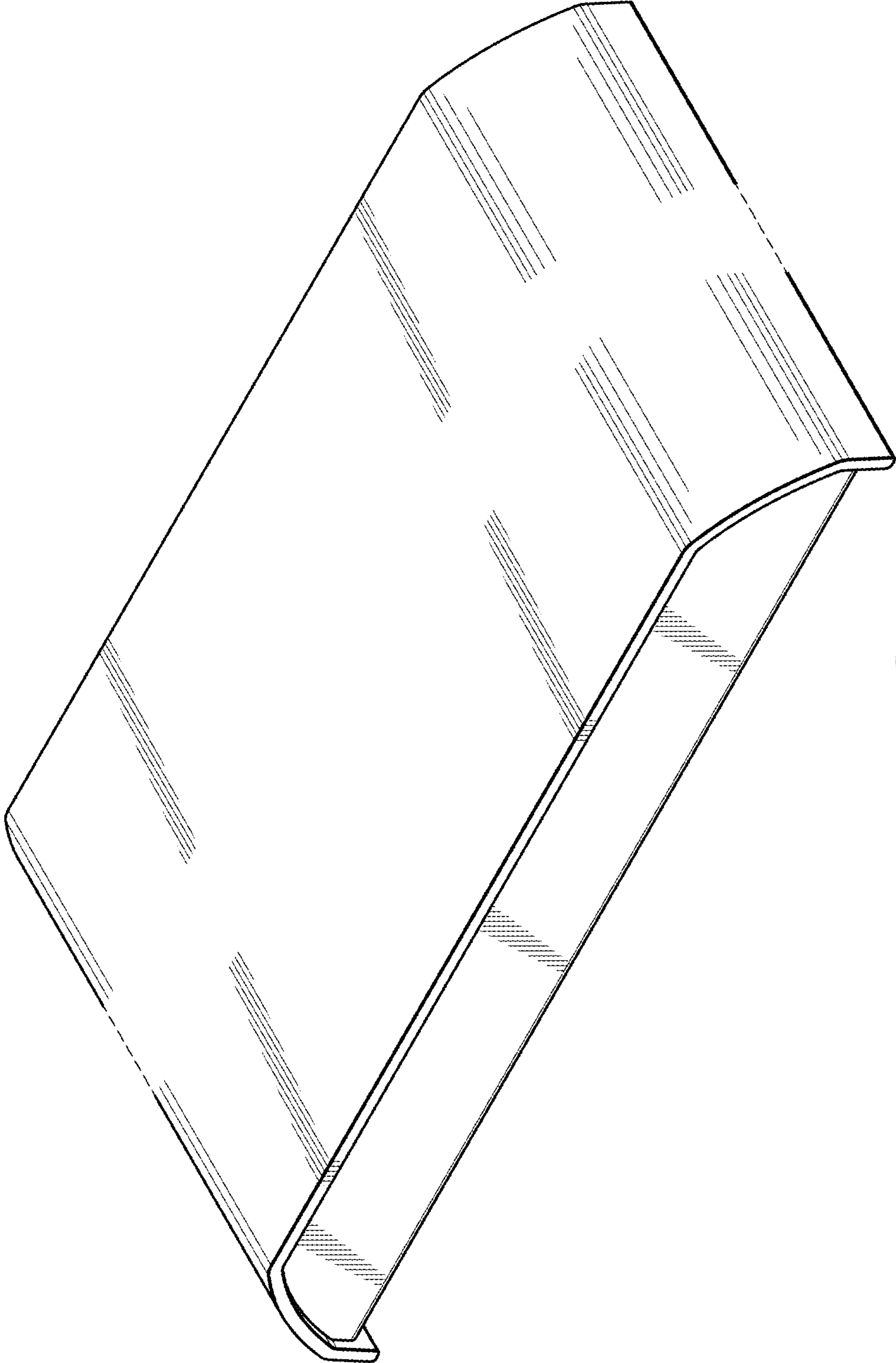




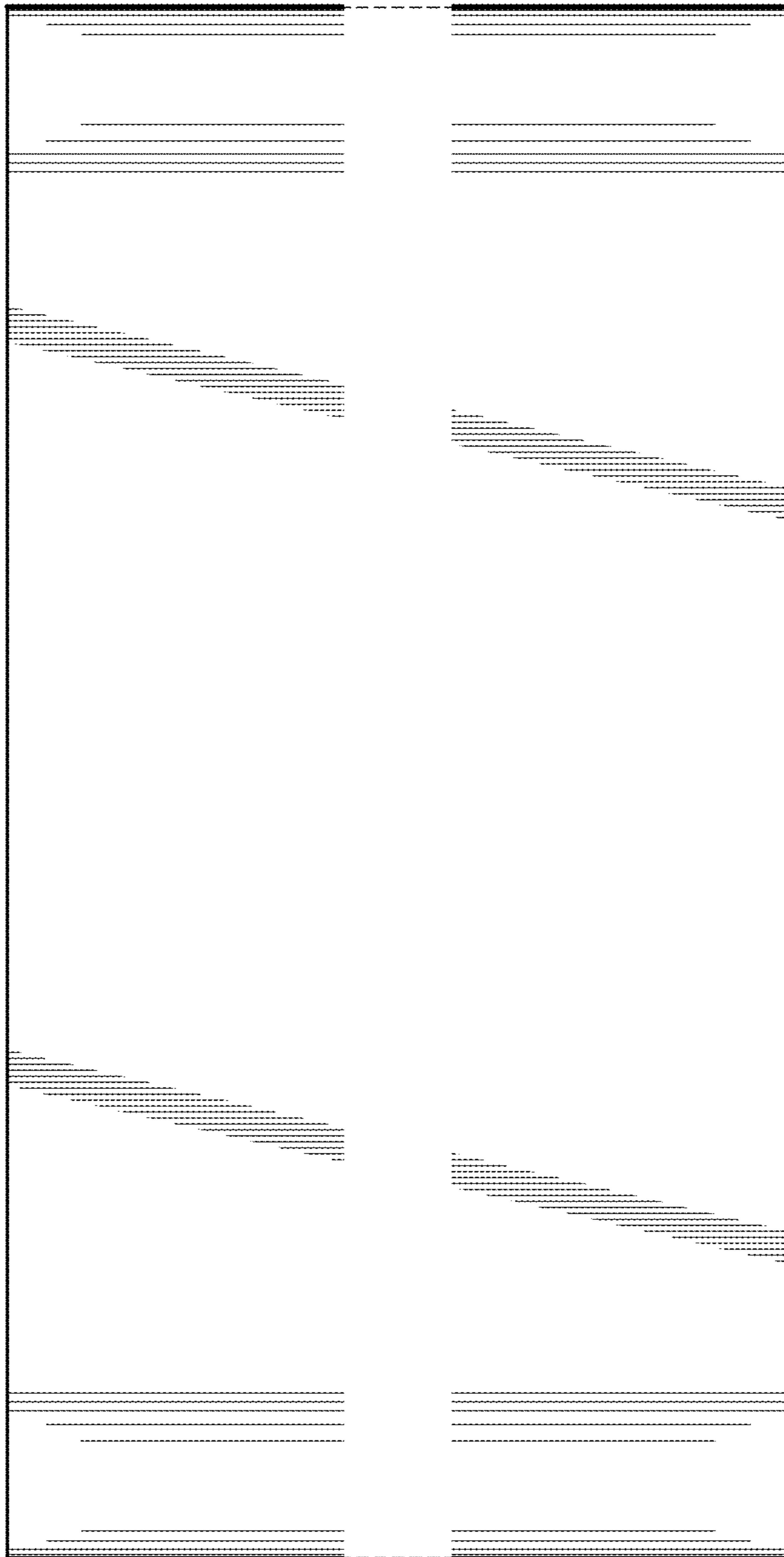
**FIG. 20**



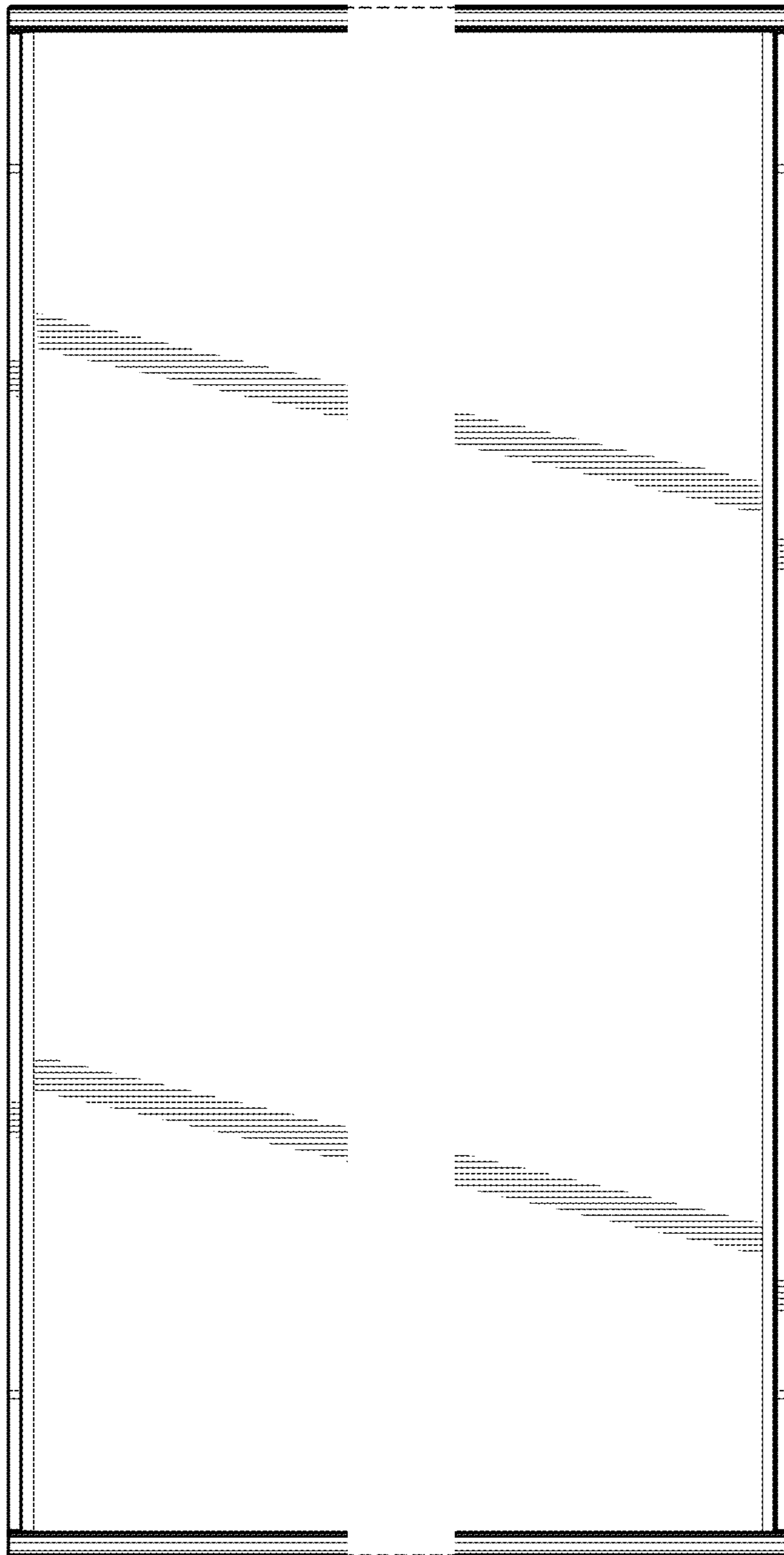
**FIG. 21**



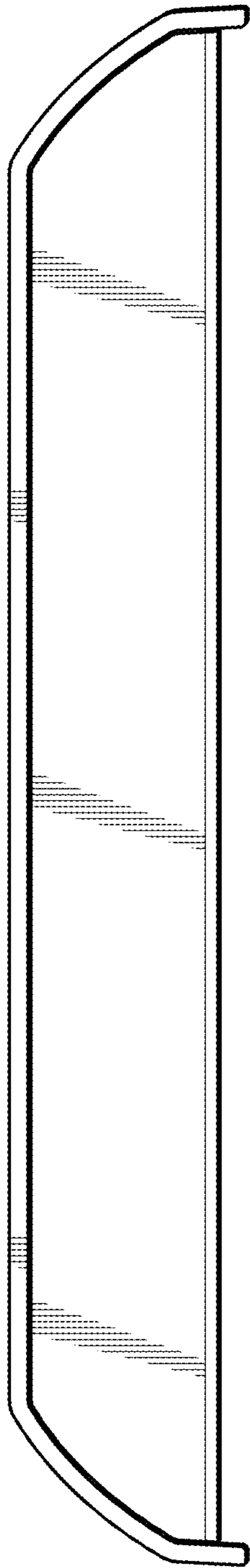
**FIG. 22**



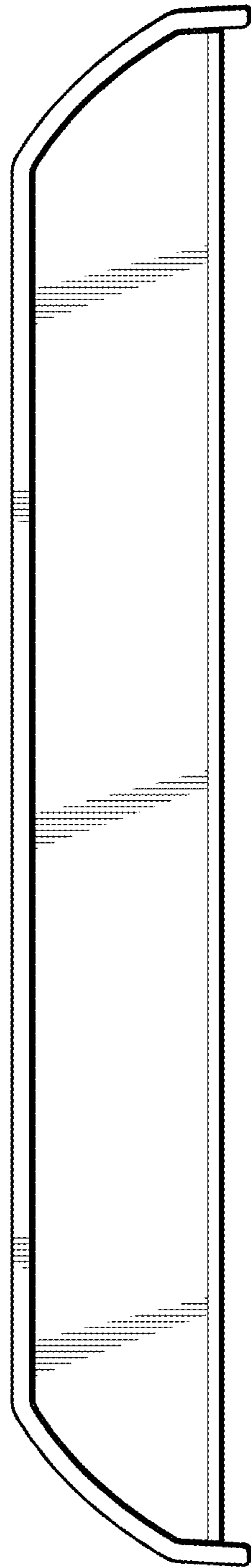
**FIG. 23**



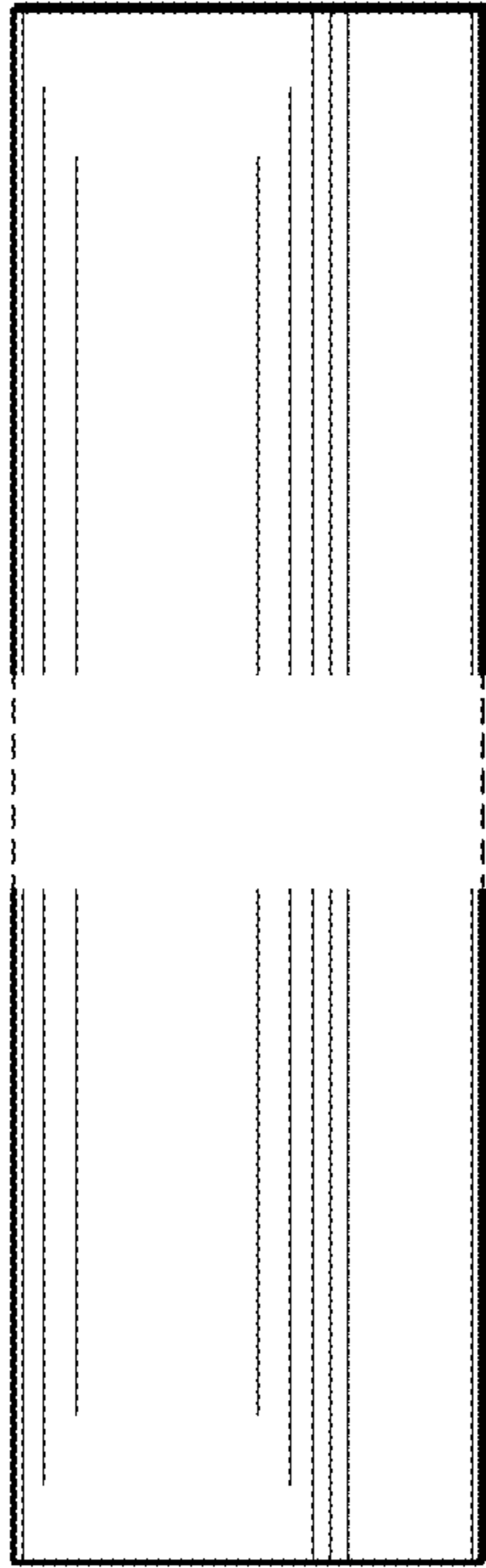
**FIG. 24**



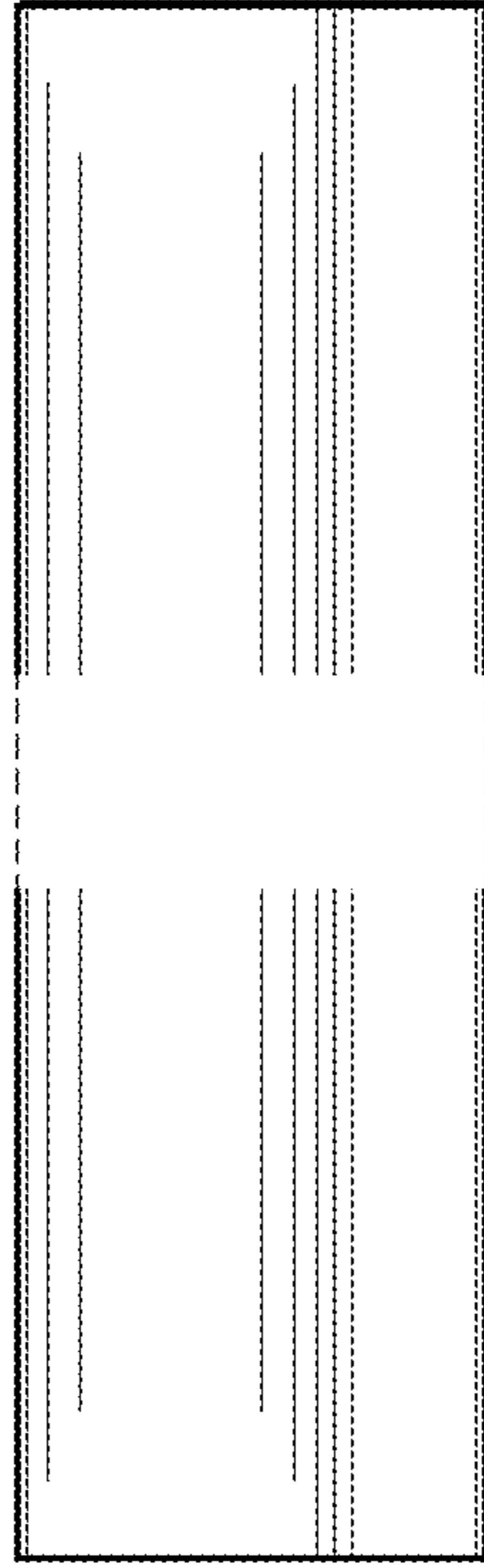
**FIG. 25**



**FIG. 26**



**FIG. 27**



**FIG. 28**