



US00D829720S

(12) **United States Design Patent**
Zhang

(10) **Patent No.:** **US D829,720 S**

(45) **Date of Patent:** **** Oct. 2, 2018**

(54) **TABLET COMPUTER CASE WITH HANDLE**

(71) Applicant: **Yanmei Zhang**, Qingyuan (CN)

(72) Inventor: **Yanmei Zhang**, Qingyuan (CN)

(**) Term: **15 Years**

(21) Appl. No.: **29/655,686**

(22) Filed: **Jul. 6, 2018**

(51) **LOC (11) Cl.** **14-02**

(52) **U.S. Cl.**
USPC **D14/440**

(58) **Field of Classification Search**

USPC D14/440; 206/45.23, 320, 45.2;
361/679.55; 294/25; 224/218

CPC ... G06F 1/1628; G06F 1/1626; A47B 23/044;
H04B 1/3888

See application file for complete search history.

D694,246 S *	11/2013	Park	D14/440
D696,864 S *	1/2014	Phillips	D3/299
D703,672 S *	4/2014	Kim	D14/440
D709,509 S *	7/2014	Kim	D14/440
D715,052 S *	10/2014	Fair	D3/301
D727,917 S *	4/2015	Yeo	D14/440
D729,252 S *	5/2015	Smith et al.	D14/440
D743,170 S *	11/2015	Akana	D3/299
D752,052 S *	3/2016	Park	D14/440
D784,350 S *	4/2017	Li	D14/440
D807,366 S *	1/2018	Chen	D14/440
2010/0230301 A1 *	9/2010	Fellig	H04B 1/3888 206/232
2012/0194448 A1 *	8/2012	Rothkopf	A45C 13/002 345/173

* cited by examiner

Primary Examiner — Cynthia R Underwood

(57) **CLAIM**

The ornamental design for a tablet computer case with handle, as shown and described.

DESCRIPTION

FIG. 1 is a perspective view of the tablet computer case with handle showing my new design;
FIG. 2 is another perspective view thereof;
FIG. 3 is a front elevational view thereof;
FIG. 4 is a rear elevational view thereof;
FIG. 5 is a left side elevational view thereof;
FIG. 6 is a right side elevational view thereof;
FIG. 7 is a top plan view thereof; and,
FIG. 8 is a bottom plan view thereof.
The broken lines are for the purposes of illustrating portions of the tablet computer case with handle and form no part of the claimed design.

1 Claim, 8 Drawing Sheets

(56) **References Cited**

U.S. PATENT DOCUMENTS

D260,456 S *	9/1981	Davies	206/314
D492,303 S *	6/2004	Schlieffers	D14/341
D591,801 S *	5/2009	Mak	D21/469
D594,004 S *	6/2009	Takemasa	D14/341
D611,253 S *	3/2010	Lown	D3/301
D611,467 S *	3/2010	Gou	D14/315
D645,251 S *	9/2011	Lee	D3/301
D672,353 S *	12/2012	Liu	D14/440
D675,627 S	2/2013	Rouser		
D676,448 S *	2/2013	Gorman	D14/440
D681,951 S *	5/2013	Phillips	D3/299
D689,056 S *	9/2013	Li	D14/440
D690,704 S *	10/2013	Padilla	D14/440
D691,144 S *	10/2013	Peters	D14/440
D691,146 S	10/2013	Perez		

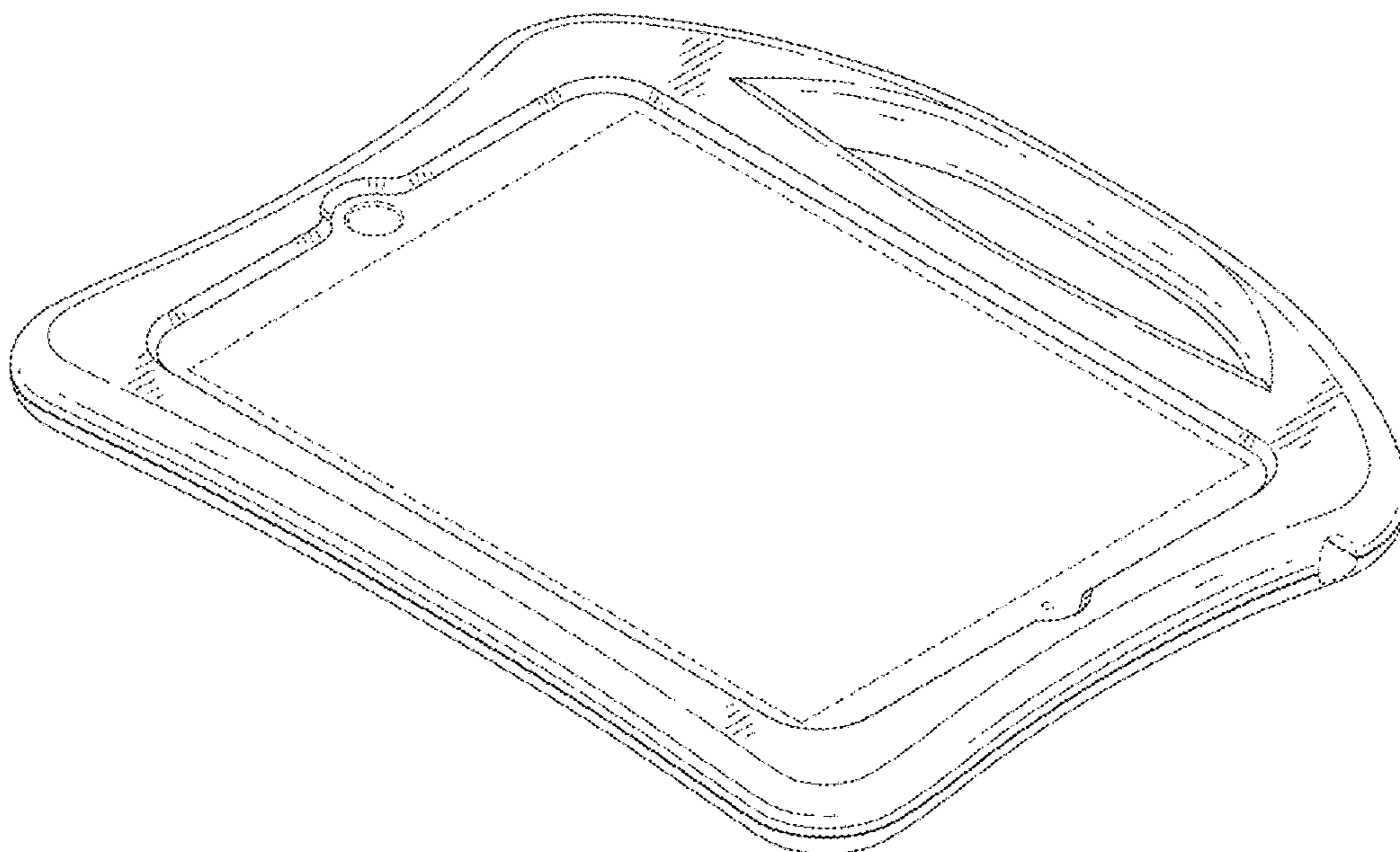

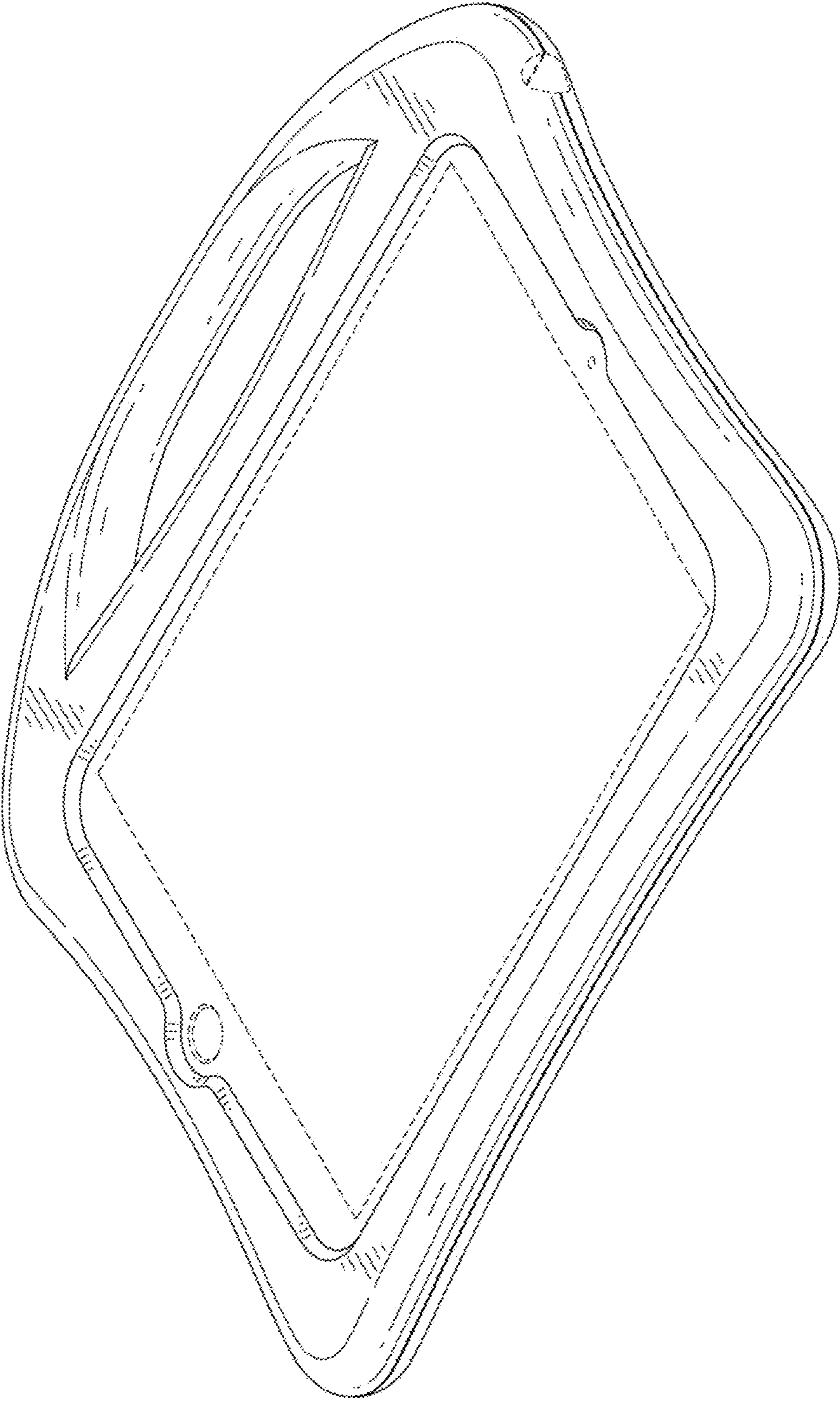

FIG. 1

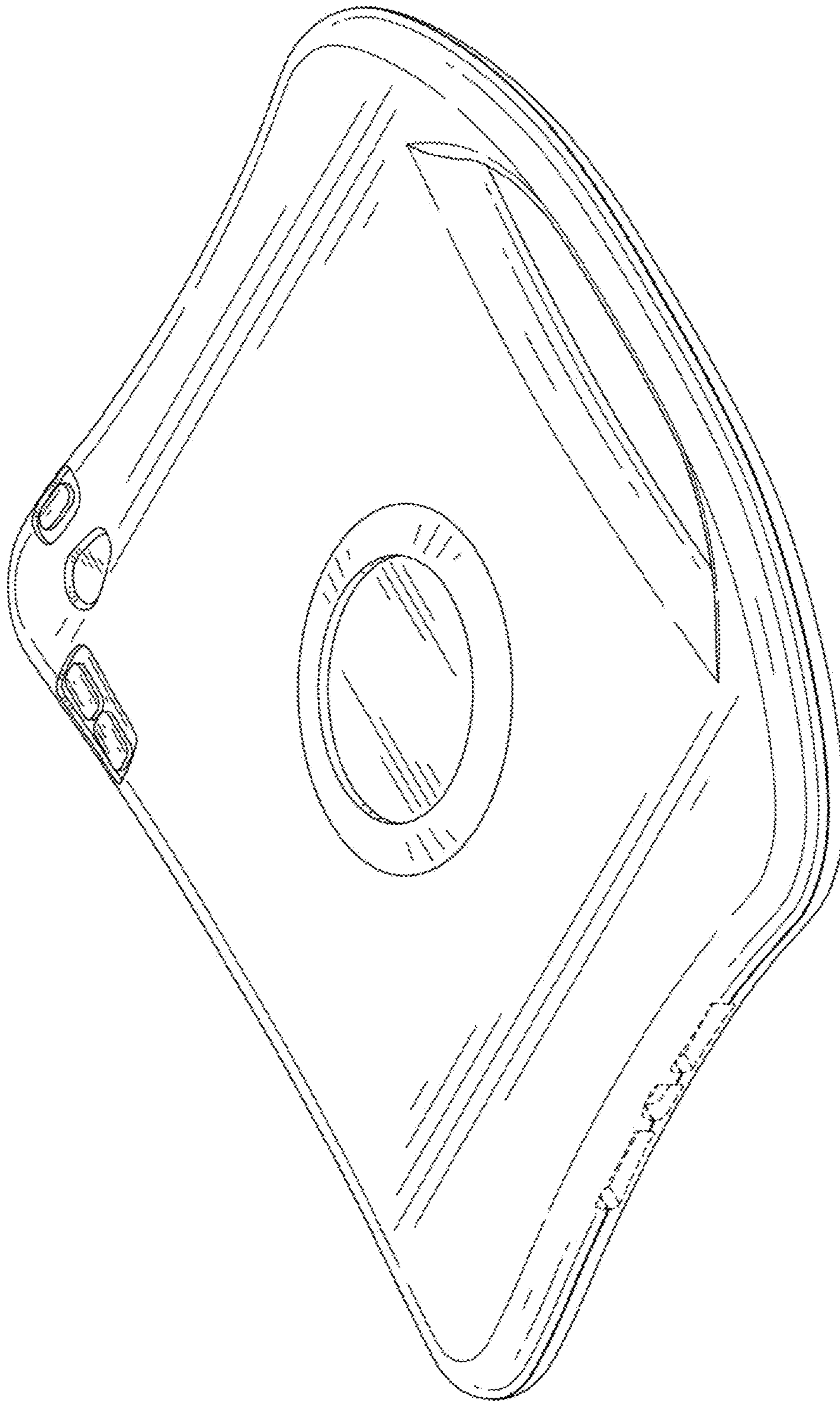

FIG. 2

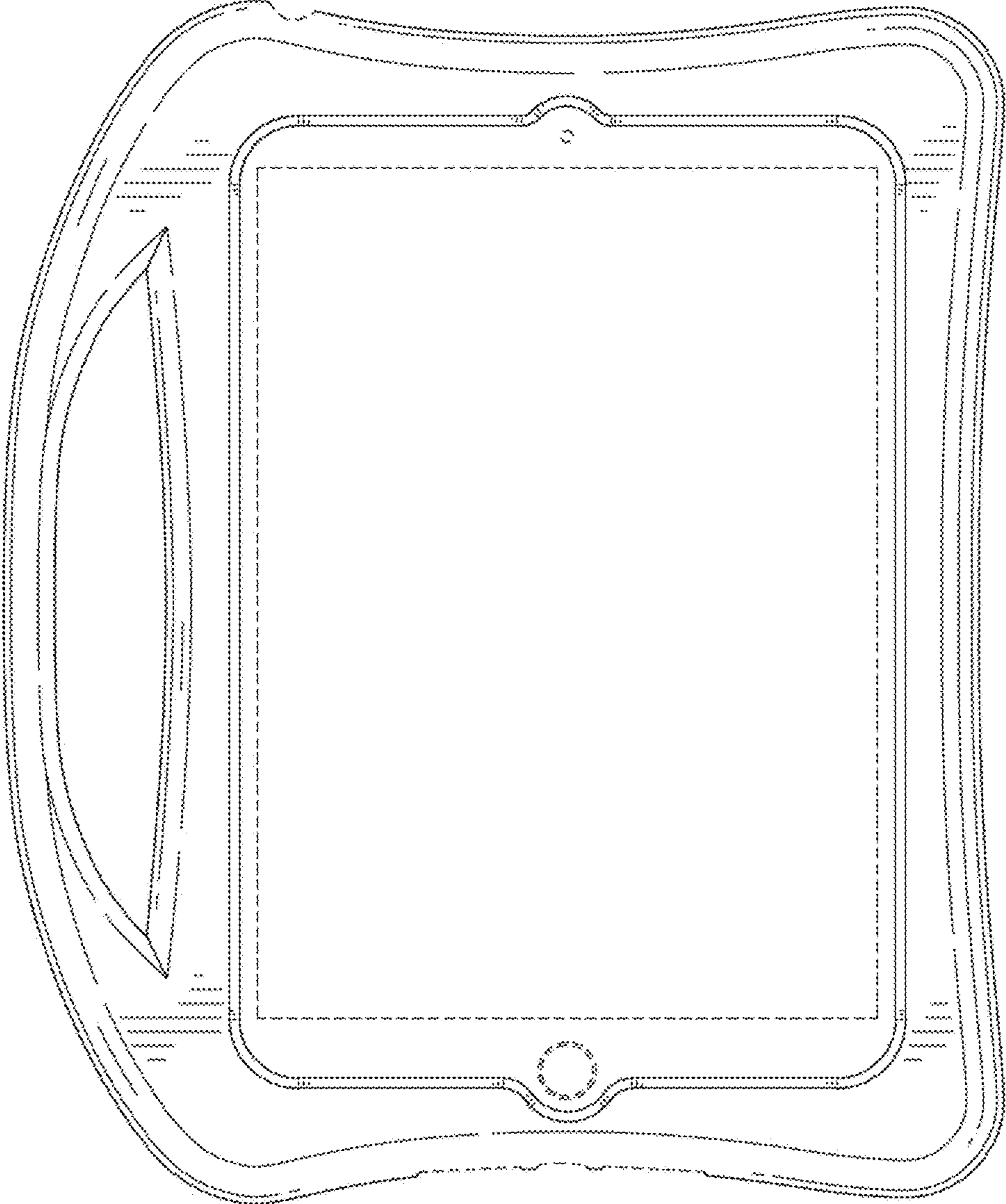

FIG. 3

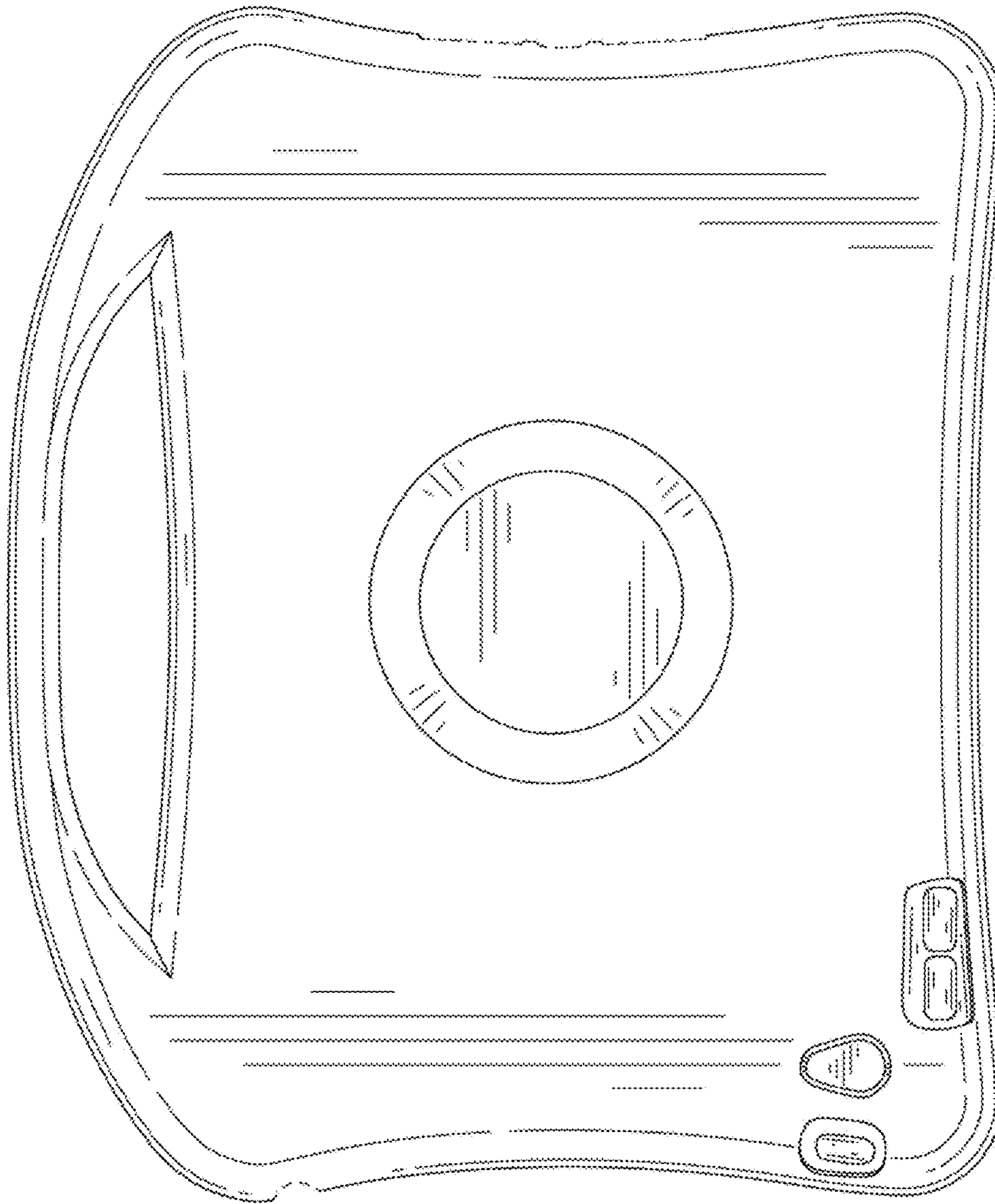

FIG. 4

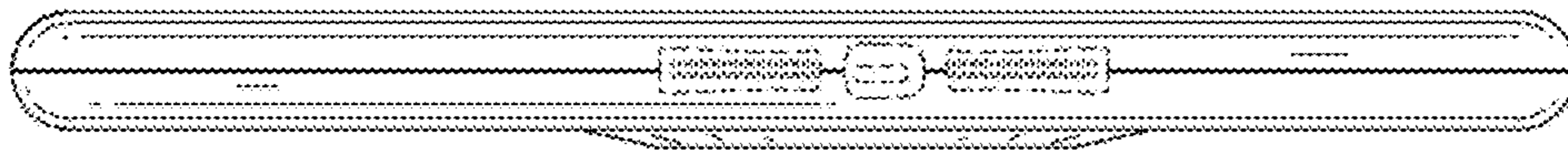

FIG. 5

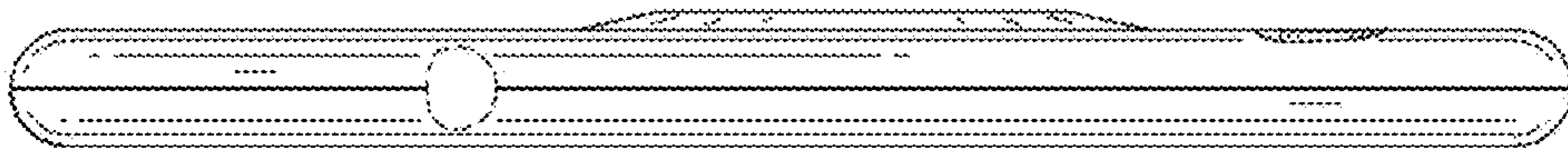

FIG. 6

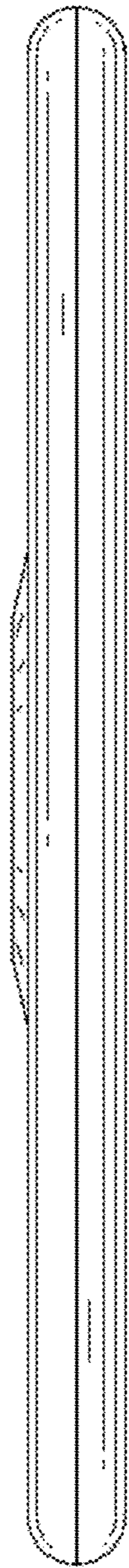

FIG. 7

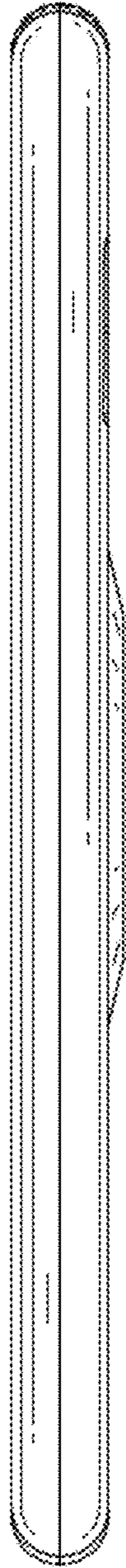

FIG. 8