



US00D829699S

(12) **United States Design Patent** (10) **Patent No.:** **US D829,699 S**  
**Jung** (45) **Date of Patent:** **\*\* \*Oct. 2, 2018**

- (54) **CASE FOR ELECTRONIC COMMUNICATIONS DEVICE**
- (71) Applicant: **SPIGEN KOREA CO., LTD.**, Seoul (KR)
- (72) Inventor: **Soo Ha Jung**, Seoul (KR)
- (73) Assignee: **SPIGEN KOREA CO., LTD.**, Seoul (KR)
- (\*) Notice: This patent is subject to a terminal disclaimer.
- (\*\*) Term: **15 Years**
- (21) Appl. No.: **29/575,953**
- (22) Filed: **Aug. 30, 2016**

**Related U.S. Application Data**

- (63) Continuation of application No. 29/574,980, filed on Aug. 19, 2016.
- (51) **LOC (11) Cl.** ..... **14-03**
- (52) **U.S. Cl.**  
USPC ..... **D14/250**
- (58) **Field of Classification Search**  
USPC ..... D14/238.1, 440, 203.3–203.7, 217, 240, D14/447, 250, 248, 251–253; D3/201,  
(Continued)

(56) **References Cited**

**U.S. PATENT DOCUMENTS**

- D619,361 S 7/2010 Andre
- D632,685 S \* 2/2011 Richardson ..... D14/250  
(Continued)

**OTHER PUBLICATIONS**

OtterboxCommuter Series Case for Samsung Galaxy S6 Review!, Published on Jul. 8, 2015, URL:<<https://www.youtube.com/watch?v=Aq9sQmSc9uc>>, retrieved from internet on May 12, 2017.\*

(Continued)

*Primary Examiner* — Carla Jobe Wright  
(74) *Attorney, Agent, or Firm* — Heedong Chae; Lucem, PC

(57) **CLAIM**

The ornamental design for a case for electronic communications device, as shown and described.

**DESCRIPTION**

FIG. 1 is a front perspective view of a case for electronic communications device showing my new design;  
 FIG. 2 is a rear perspective view thereof;  
 FIG. 3 is a front elevational view thereof;  
 FIG. 4 is a rear elevational view thereof;  
 FIG. 5 is a left side elevational view thereof;  
 FIG. 6 is a right side elevational view thereof;  
 FIG. 7 is a top plan view thereof;  
 FIG. 8 is a bottom plan view thereof;  
 FIG. 9 is a rear perspective view thereof, showing the support leg in an extended configuration;  
 FIG. 10 is an exploded front perspective view thereof, showing the inner shell, outer frame, and support leg separated for clarity of disclosure;  
 FIG. 11 is an exploded rear perspective view thereof, showing the inner shell, outer frame, and support leg separated for clarity of disclosure;  
 FIG. 12 is a front perspective view of the outer frame component of the case shown separately for clarity of disclosure;  
 FIG. 13 is a rear perspective view thereof shown separately for clarity of disclosure;  
 FIG. 14 is a front perspective view of the inner shell component of the case shown separately for clarity of disclosure;  
 FIG. 15 is a rear perspective view thereof shown separately for clarity of disclosure;  
 FIG. 16 is a front perspective view of the support leg component of the case shown separately for clarity of disclosure; and,  
 FIG. 17 is a rear perspective view thereof shown separately for clarity of disclosure.

Although the case for electronic communications device, in which the claimed design is embodied, consists of an inner

(Continued)

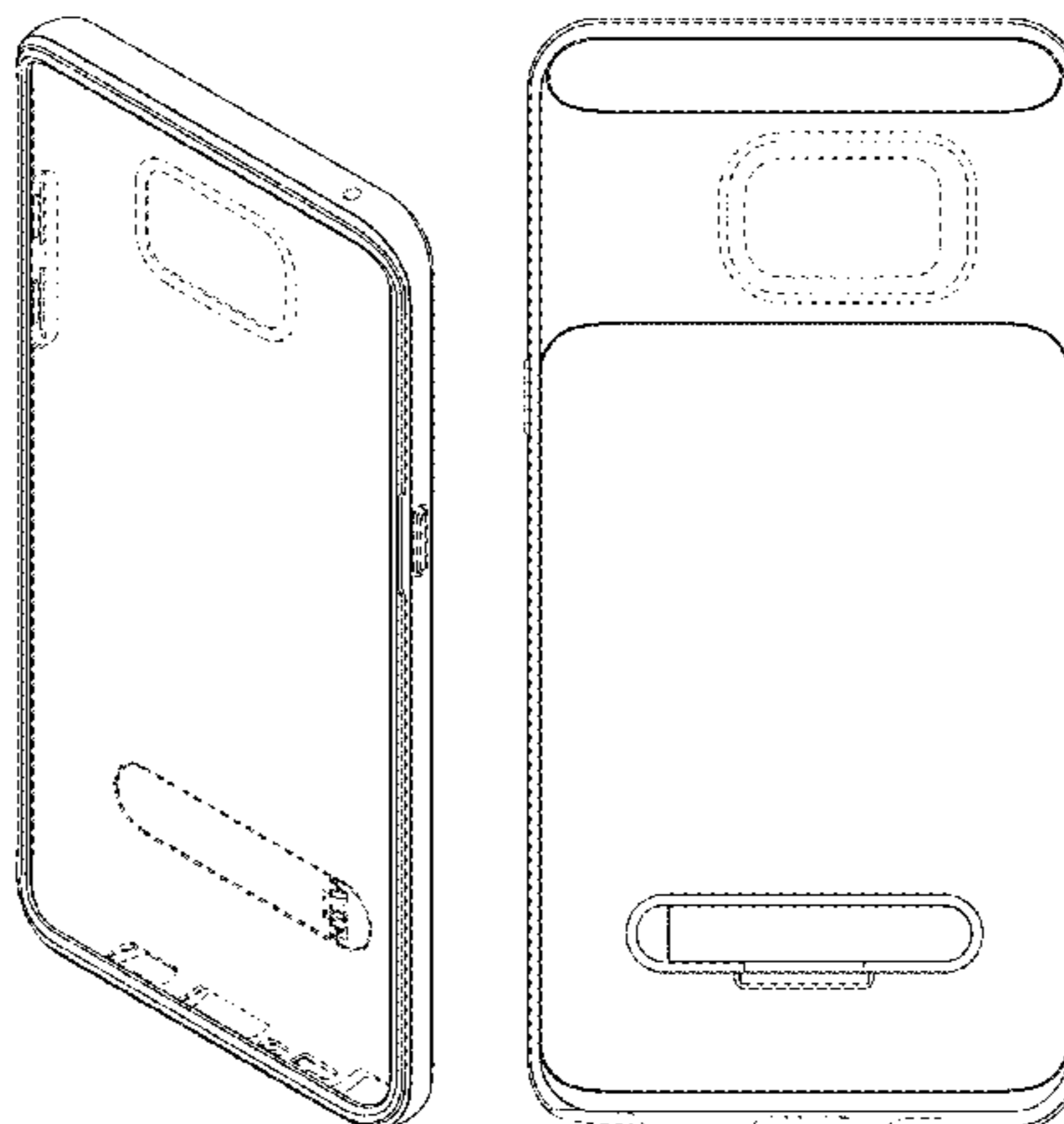

shell, an outer frame, and a support leg, the claim is directed to the ornamental appearance of the case for electronic communications device in its entirety and does not extend to the ornamental appearance of each of the individual components of the case for electronic communications device. The broken lines throughout the drawing figures depict portions of the case for electronic communications device that form no part of the claimed design. The broken lines and regions bounded by broken lines form no part of the claimed design.

The interior of the case shown in FIGS. 1, 3, 10, and 14 forms no part of the claimed design.

**1 Claim, 17 Drawing Sheets**

(58) **Field of Classification Search**

USPC ..... D3/218, 247, 269, 273, 301, 303;  
D13/103, 107-108, 119  
CPC ..... H04B 1/3888; H04M 1/0283;  
H04M 1/0202; A45C 1/06; A45C  
2011/002; A45C 11/00; A45C 13/02;  
A45F 2005/026; A45F 2200/0525; A45F  
2200/0516

See application file for complete search history.

(56) **References Cited**

U.S. PATENT DOCUMENTS

D634,741 S \* 3/2011 Richardson ..... D14/250  
D644,216 S \* 8/2011 Richardson ..... D14/250  
D663,263 S \* 7/2012 Gupta ..... D13/103  
D679,271 S \* 4/2013 Liu ..... D13/103  
D699,714 S \* 2/2014 Melanson ..... D14/250  
D706,254 S \* 6/2014 Chang ..... D14/217  
D714,276 S 9/2014 Hu  
D717,774 S \* 11/2014 Fathollahi ..... D14/250  
9,185,954 B2 11/2015 Cheung  
D746,805 S 1/2016 Kim  
D747,708 S 1/2016 Roberts  
D748,614 S \* 2/2016 Ju ..... D14/250  
D749,068 S 2/2016 Zaborski

D749,535 S 2/2016 Joung  
D749,555 S \* 2/2016 Poon ..... D14/250  
D749,557 S 2/2016 Feng  
D751,540 S 3/2016 Shin et al.  
D753,641 S 4/2016 Roberts et al.  
D754,651 S 4/2016 Roberts et al.  
9,301,584 B2 4/2016 Butts  
D756,343 S 5/2016 Wall et al.  
D756,909 S 5/2016 Gupta  
D760,710 S 7/2016 Ozolins et al.  
D761,239 S 7/2016 Kim  
D763,242 S 8/2016 Kim  
D763,842 S 8/2016 Chang et al.  
D765,635 S \* 9/2016 Chang ..... D14/250  
D765,645 S \* 9/2016 Kim ..... D14/250  
D767,485 S 9/2016 To et al.  
D767,553 S \* 9/2016 Fathollahi ..... D14/250  
D771,028 S 11/2016 Kim  
D771,030 S 11/2016 Tussy  
D771,608 S 11/2016 Kim  
D771,611 S 11/2016 Chang et al.  
D775,619 S \* 1/2017 Tien ..... D14/250  
D776,104 S \* 1/2017 Tien ..... D14/250  
D776,647 S \* 1/2017 Kim ..... D14/250  
D777,155 S \* 1/2017 Kim ..... D14/250  
D777,717 S \* 1/2017 Kim ..... D14/250  
2012/0168577 A1 \* 7/2012 Cheng ..... F16M 11/105  
248/176.3  
2014/0332418 A1 \* 11/2014 Cheung ..... F16M 11/10  
206/45.2  
2015/0162767 A1 6/2015 Oh  
2015/0180524 A1 6/2015 Lambert  
2015/0180526 A1 6/2015 Hidaka  
2015/0244408 A1 8/2015 Chen  
2015/0245522 A1 8/2015 Kang  
2016/0094263 A1 \* 3/2016 Fathollahi ..... H04B 1/3888  
455/575.8

OTHER PUBLICATIONS

“Galaxy S6 Case, Caseology,”[https://www.amazon.com/gp/product/B00T5C5LX0/ref=as\\_li\\_qf\\_sp\\_asin\\_il\\_tl?ie=UTF8&camp=1789&creative=9325&creativeASIN=B00T5C5LX0&linkCode=a%E2%80%A6](https://www.amazon.com/gp/product/B00T5C5LX0/ref=as_li_qf_sp_asin_il_tl?ie=UTF8&camp=1789&creative=9325&creativeASIN=B00T5C5LX0&linkCode=a%E2%80%A6), Downloaded Aug. 28, 2016, 8Page.

\* cited by examiner

FIG. 1

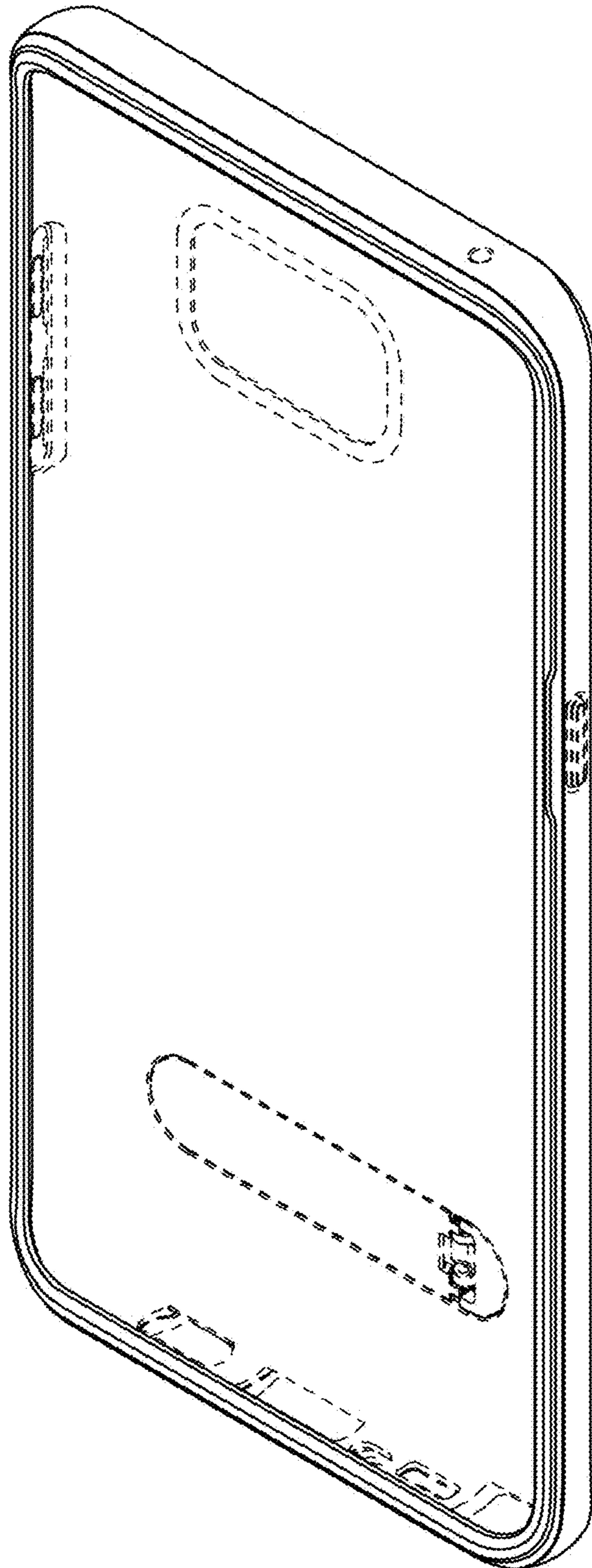



FIG. 2

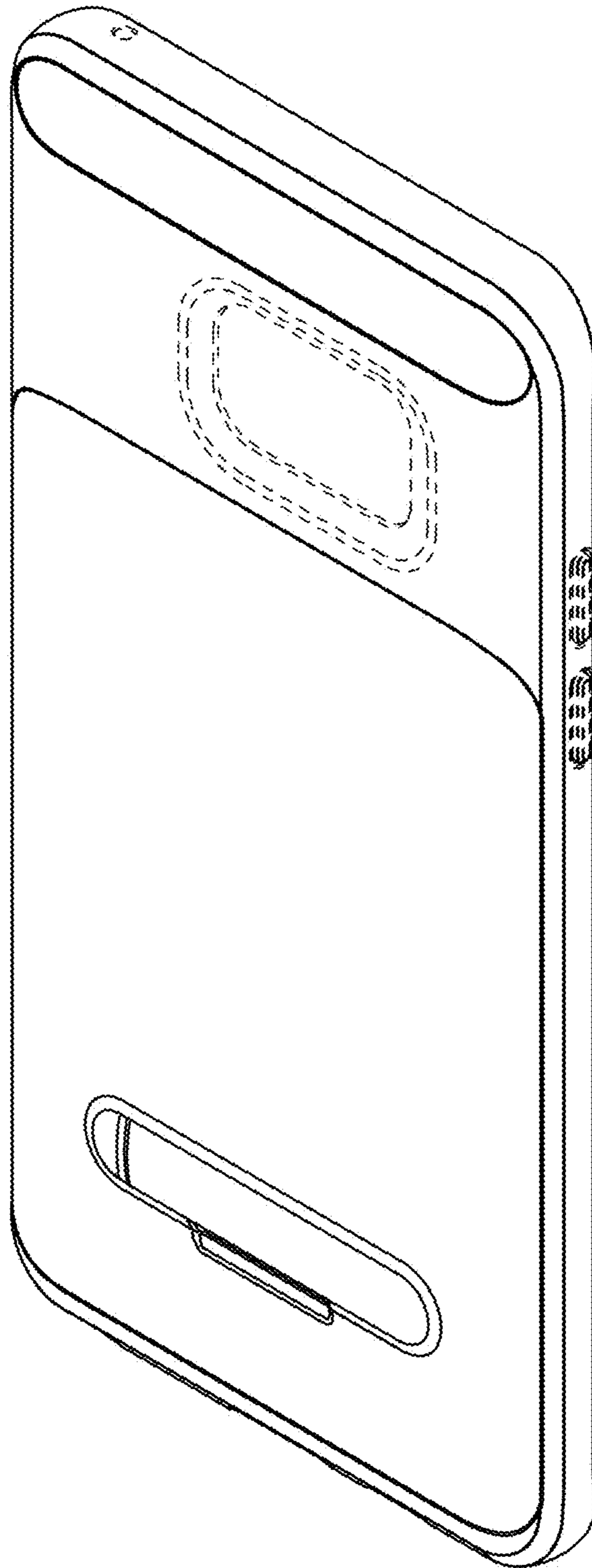

FIG. 3

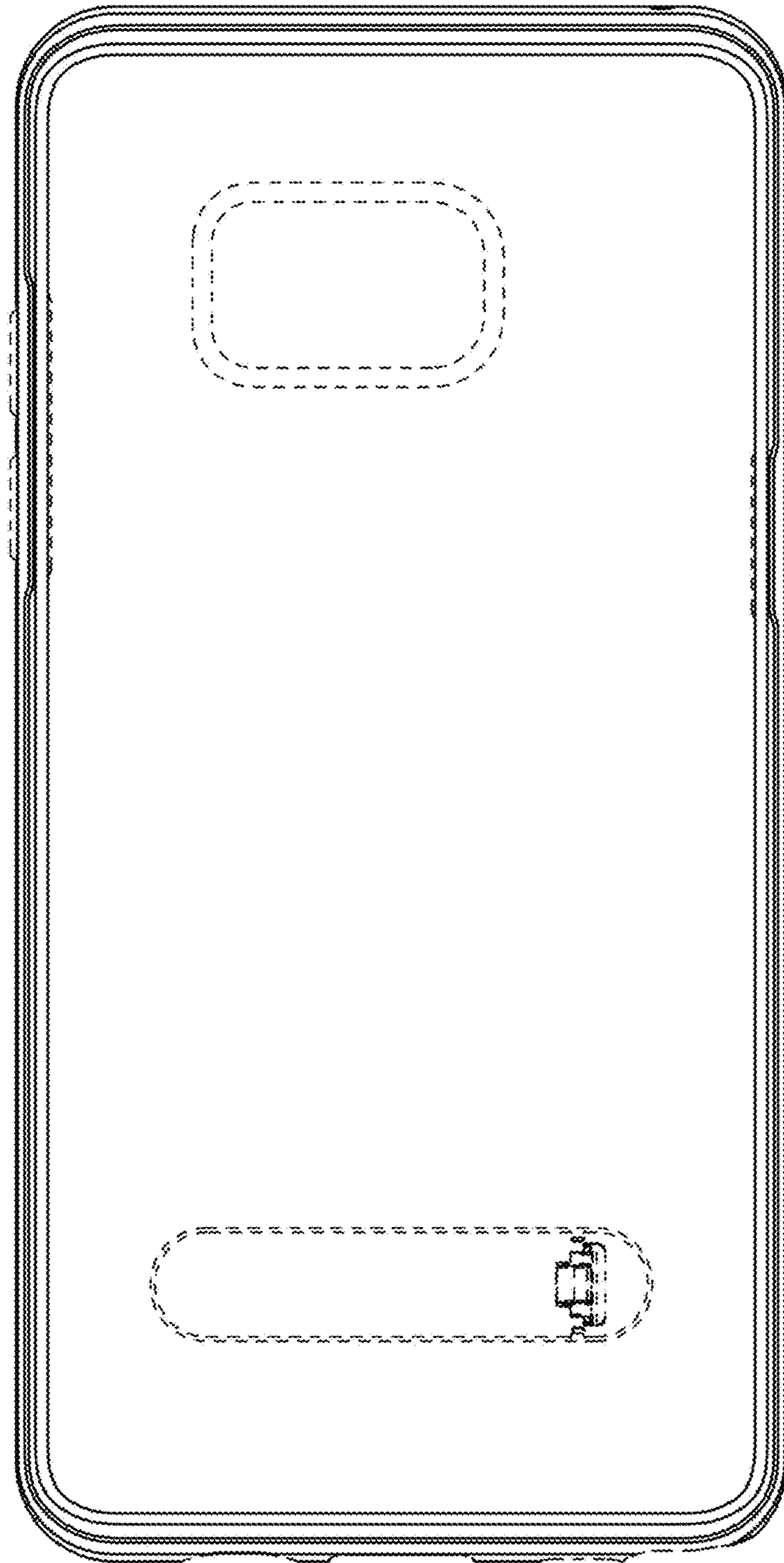

FIG. 4

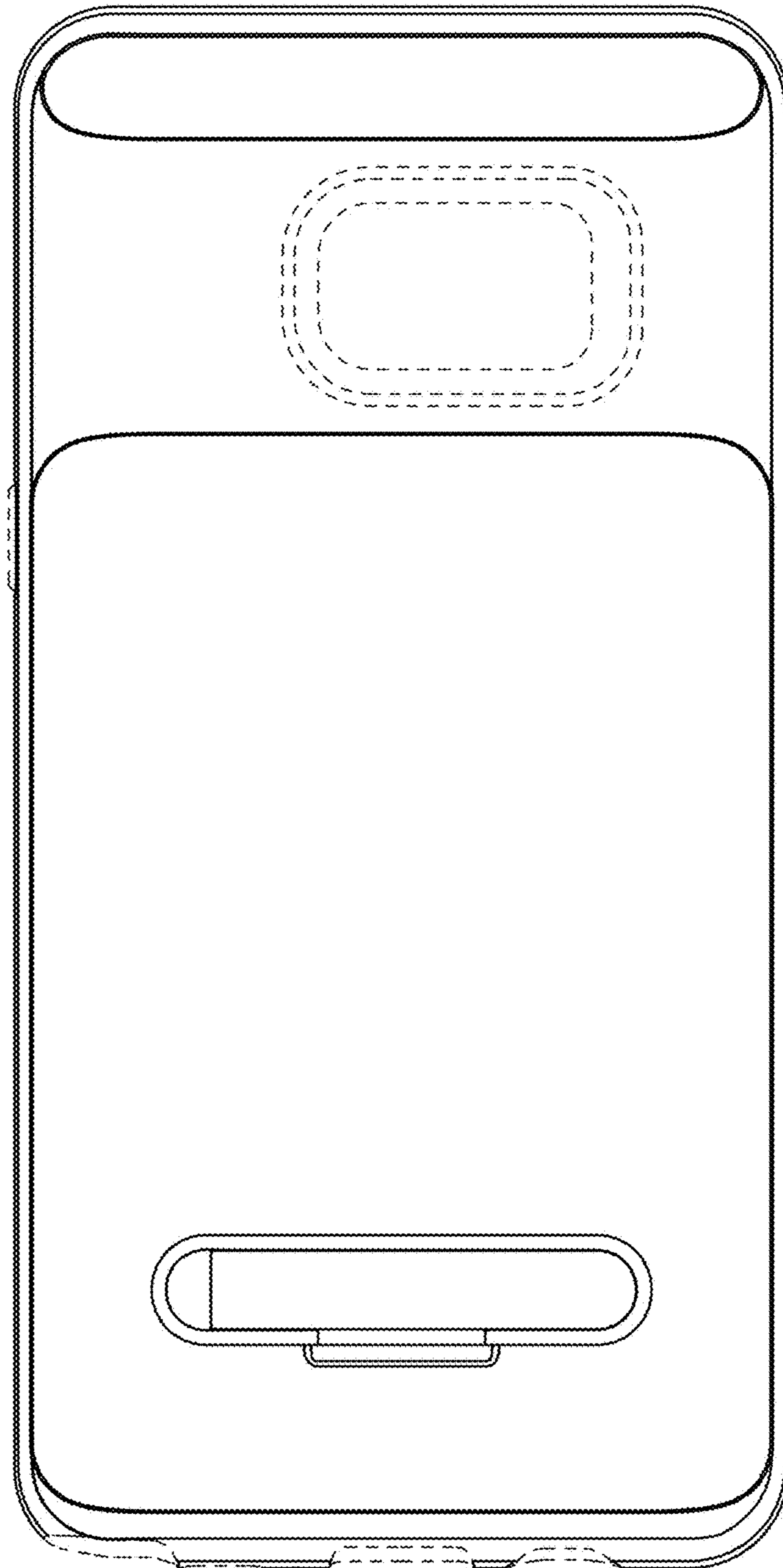

FIG. 5

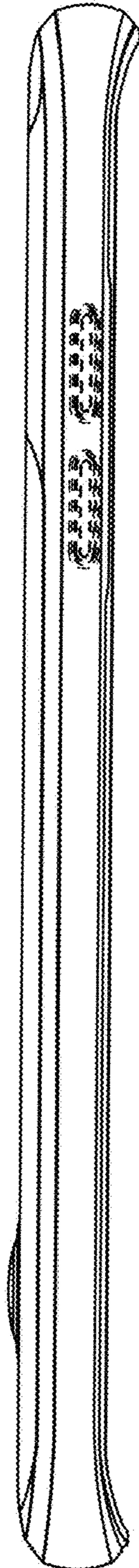

FIG. 6

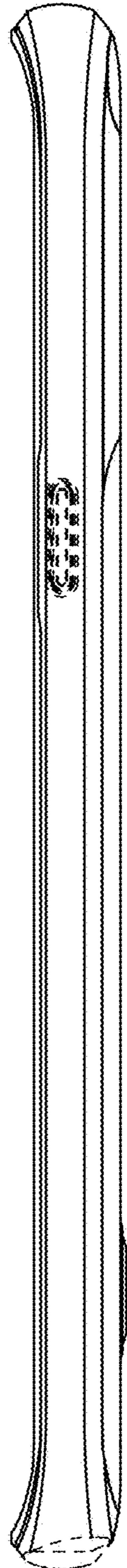



FIG. 7

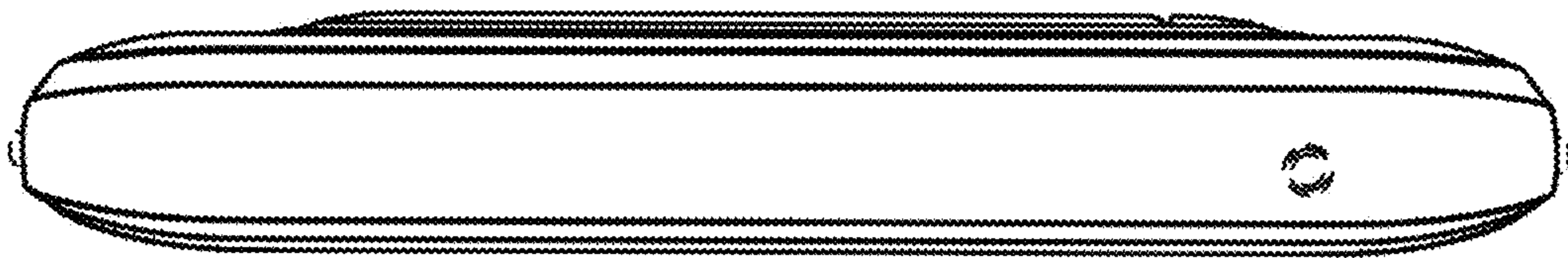

FIG. 8

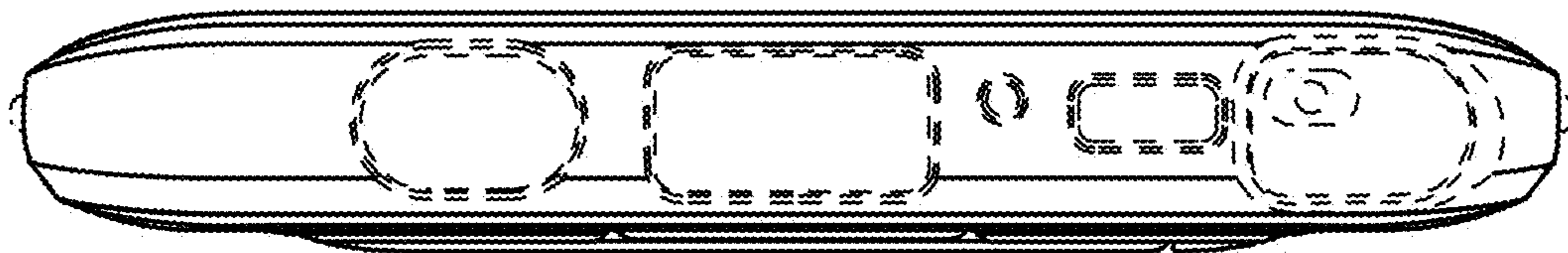

FIG. 9

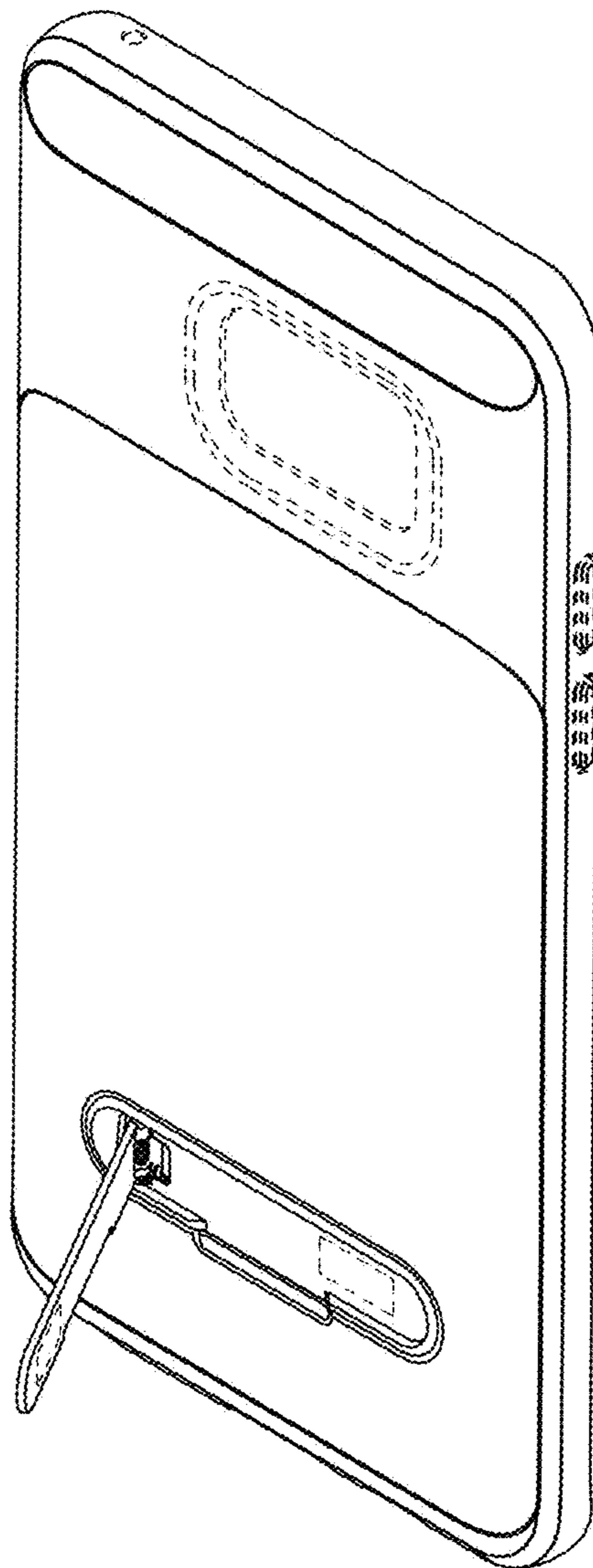

FIG. 10

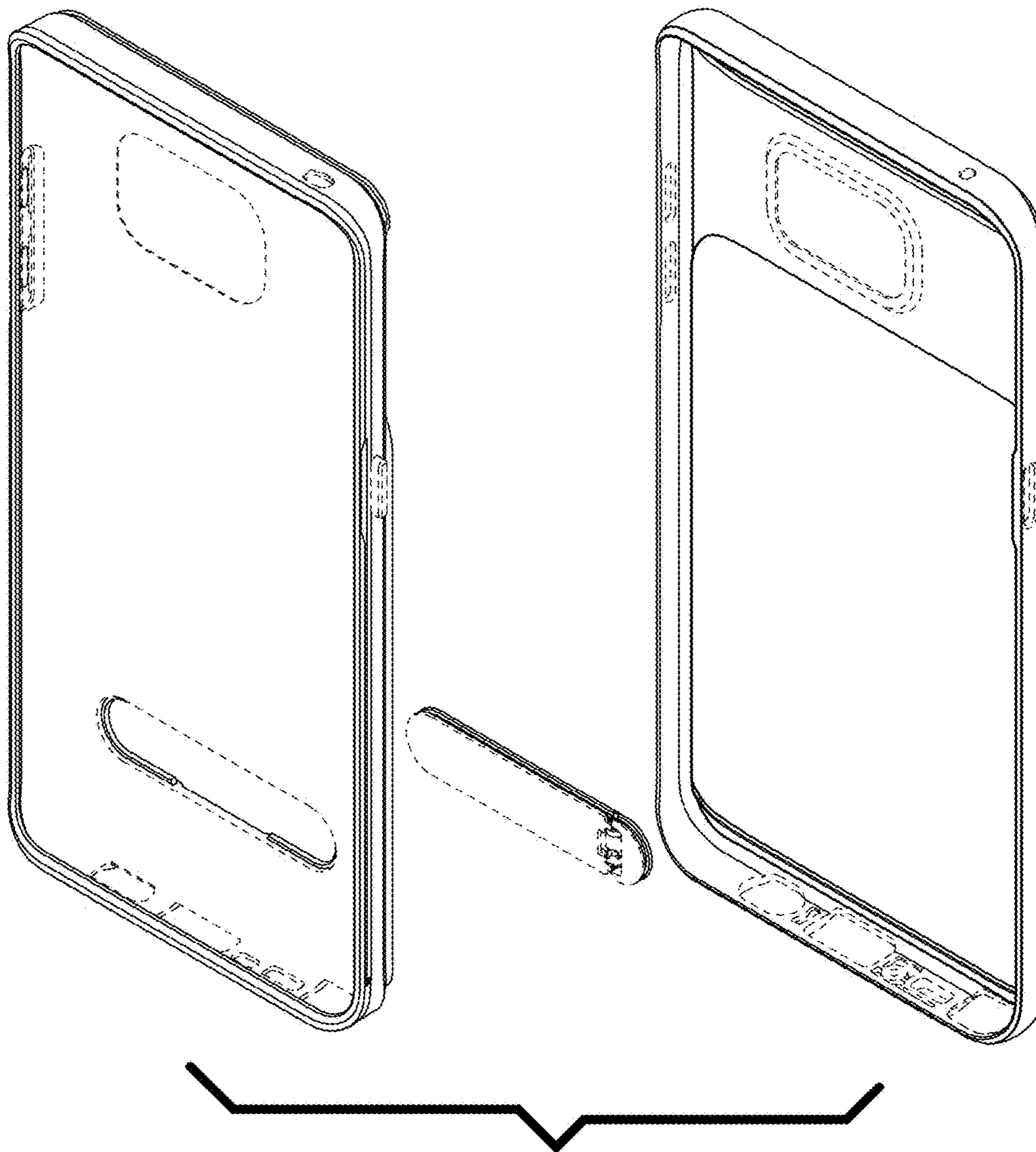



FIG. 11

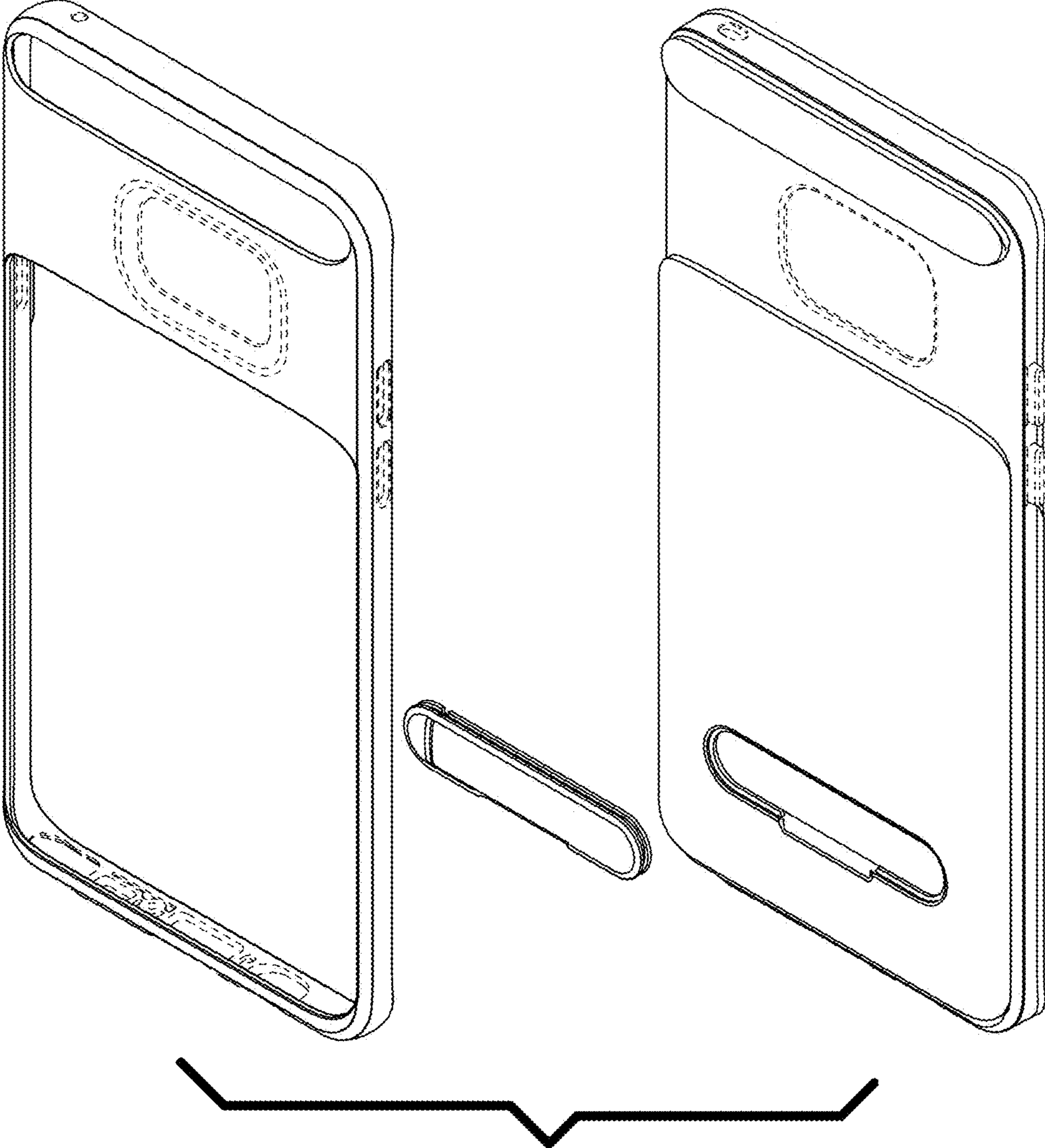

FIG. 12

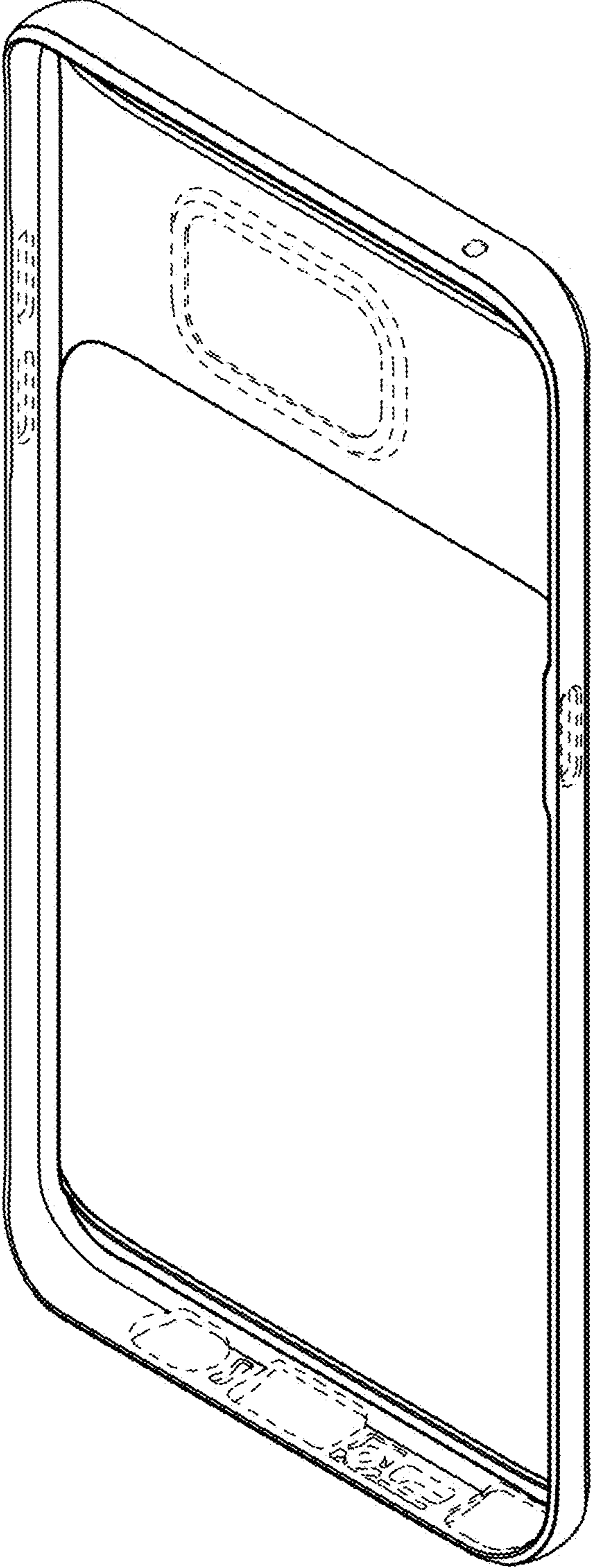

FIG. 13

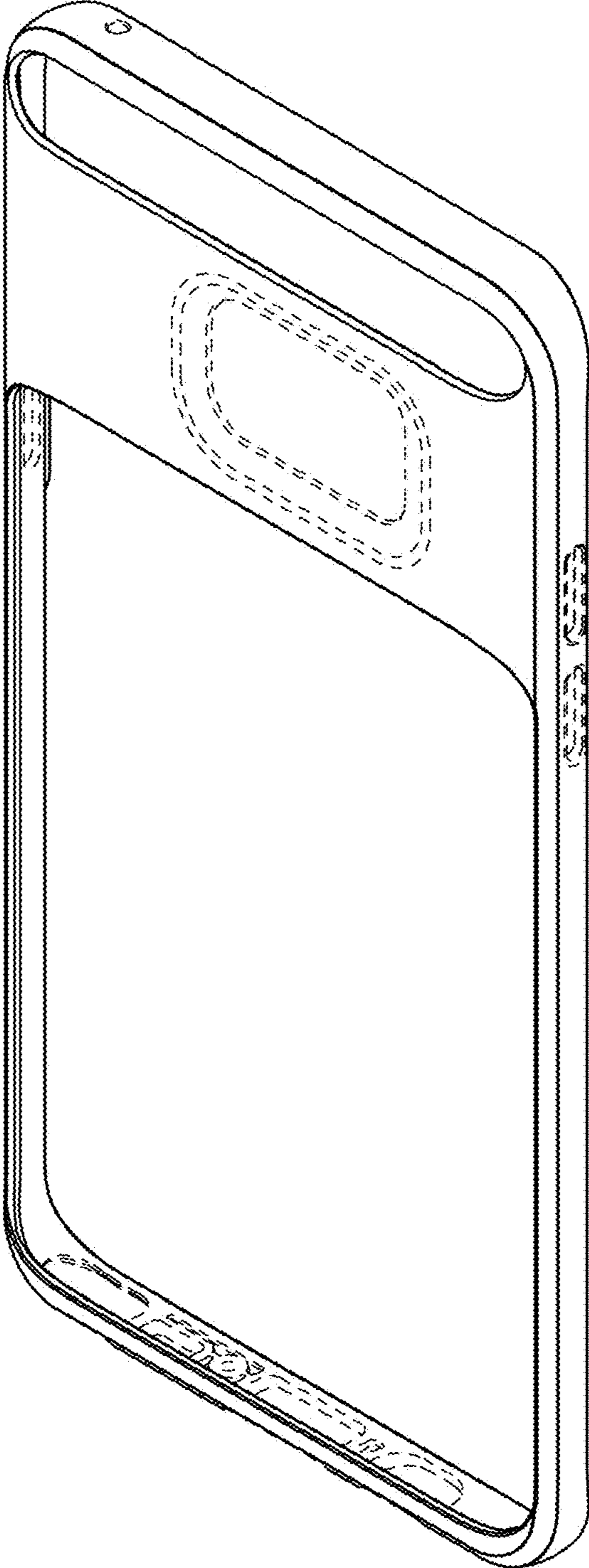

FIG. 14

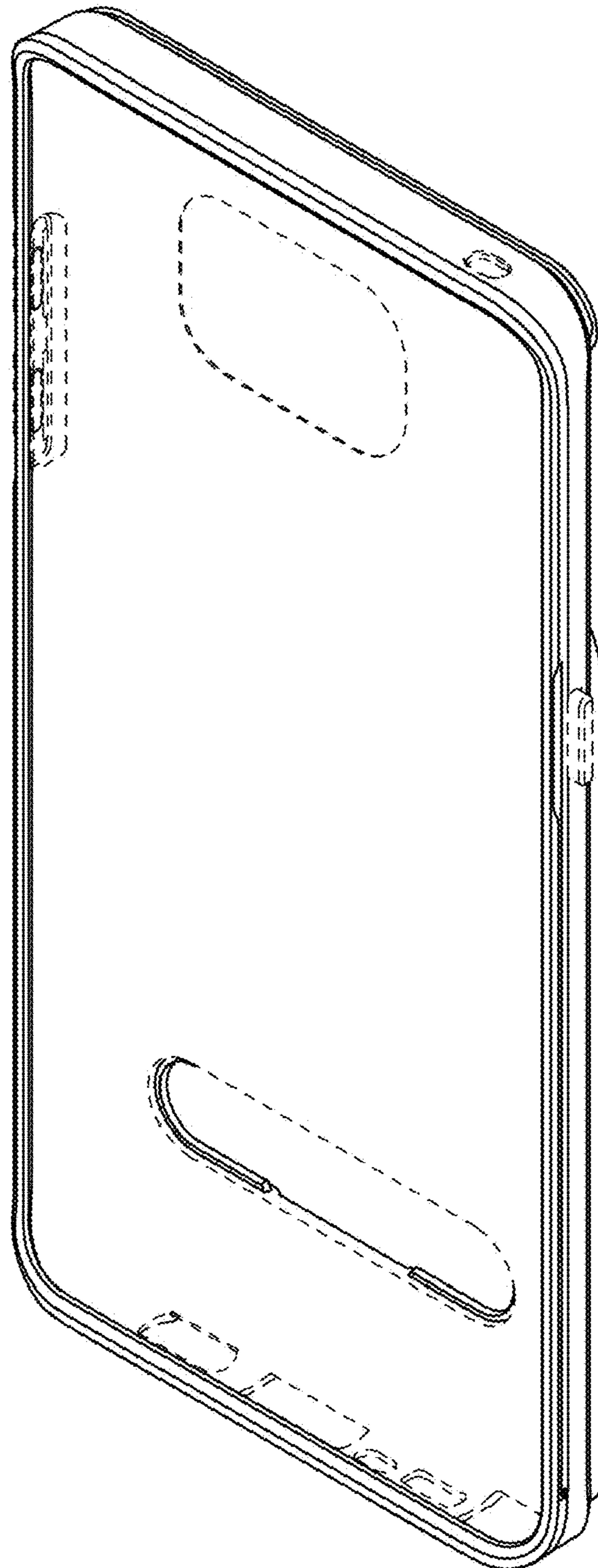



FIG. 15

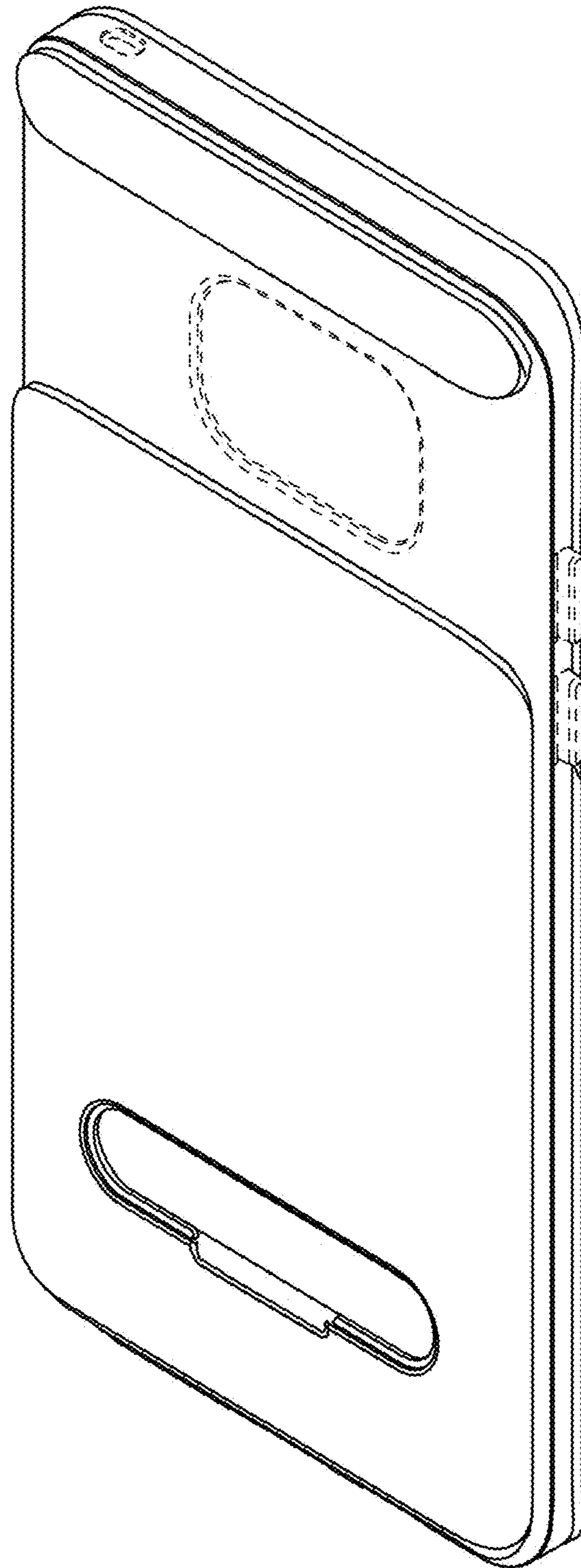

FIG. 16

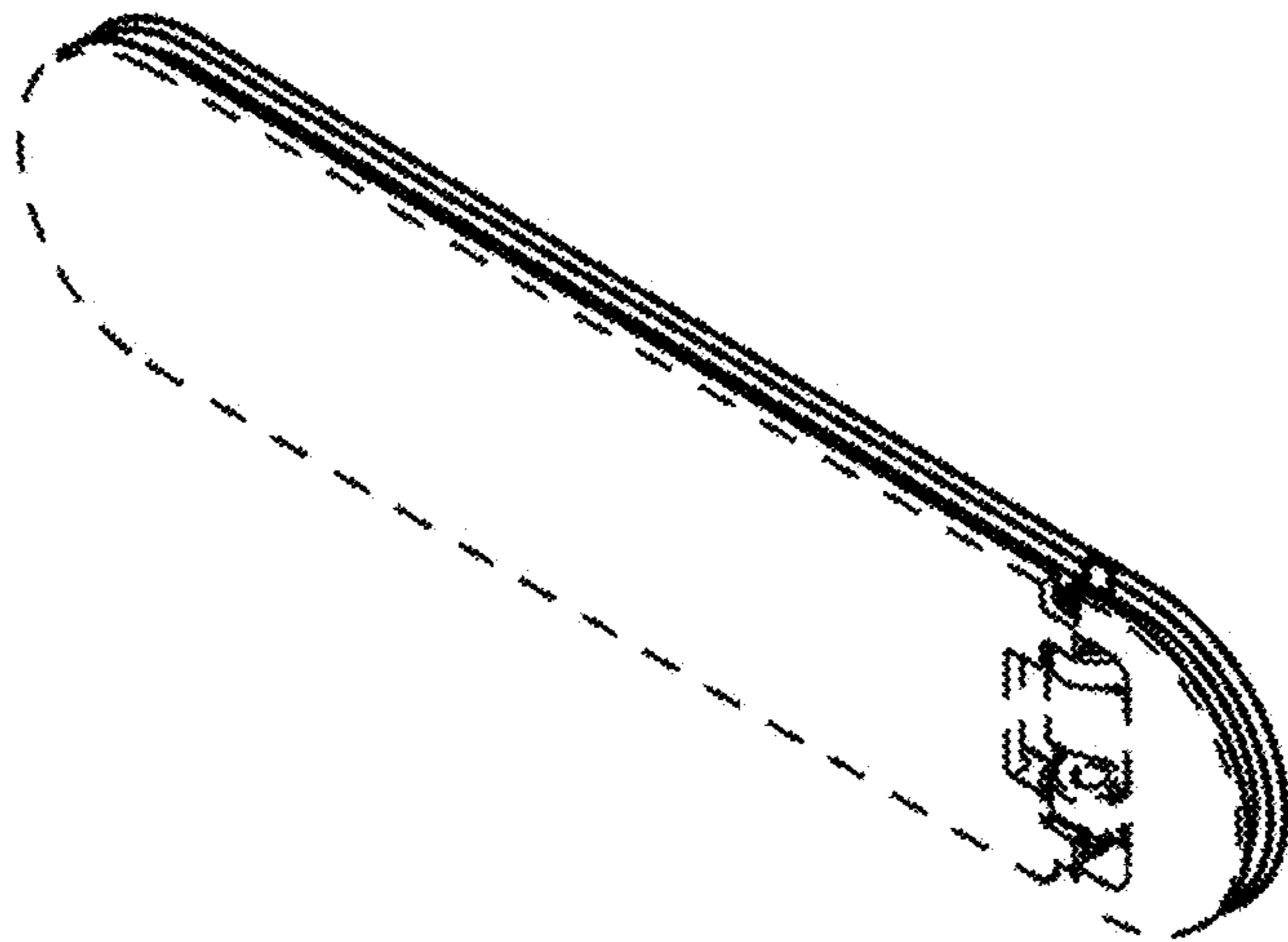

FIG. 17

