



US00D829698S

(12) **United States Design Patent** (10) **Patent No.:** **US D829,698 S**
Zhang et al. (45) **Date of Patent:** **** Oct. 2, 2018**

(54) **ELECTRONIC DEVICE**

(71) Applicant: **Samsung Electronics Co., Ltd.**,
Suwon-si (KR)

(72) Inventors: **Xiangrong Zhang**, Beijing (CN); **Chen Cui**, Beijing (CN); **Miika Johannes Mahonen**, Beijing (CN)

(73) Assignee: **Samsung Electronics Co., Ltd.**,
Suwon-si (KR)

(**) Term: **15 Years**

(21) Appl. No.: **29/587,076**

(22) Filed: **Dec. 9, 2016**

(30) **Foreign Application Priority Data**

Sep. 26, 2016 (KR) 30-2016-0046378

(51) **LOC (11) Cl.** **14-03**

(52) **U.S. Cl.**
USPC **D14/248**

(58) **Field of Classification Search**

USPC D14/138 AB, 138 AC, 138 C, 138 R,
D14/138 G, 248, 341, 342, 250, 439, 371,
D14/388, 389, 230
CPC G06F 1/1626; G06F 1/1652; H04M 1/027;
H04M 1/0202; H04M 1/0279; H04M
1/0235; H04M 1/0237; H04M 1/0239;
H04M 1/0266; H04M 1/0295; H01Q
1/243; H01Q 1/241

See application file for complete search history.

(56) **References Cited**

U.S. PATENT DOCUMENTS

D656,917 S * 4/2012 Tom D14/138 G
D667,398 S * 9/2012 Koh D14/341
D670,260 S * 11/2012 Kim D14/138 G
D675,586 S * 2/2013 Choi D14/138 G
D686,176 S * 7/2013 Kim D14/138 G

D689,457 S * 9/2013 Kim D14/138 G
D689,839 S * 9/2013 Kim D14/138 G
D693,788 S * 11/2013 Kanayama D14/138 G

(Continued)

OTHER PUBLICATIONS

Samsung Galaxy C7 Pro , Feb. 2017, [online], [site visited Apr. 23, 2018]. Retrieved from url:https://www.gsmarena.com/samsung_galaxy_c7_pro-pictures-8435.php (Year: 2017).*

(Continued)

Primary Examiner — Jeffrey David Asch

Assistant Examiner — Tracey J Bell

(74) *Attorney, Agent, or Firm* — NSIP Law

(57) **CLAIM**

We claim the ornamental design for an electronic device, as shown and described.

DESCRIPTION

FIG. 1 is the front perspective view of an electronic device showing our new design;

FIG. 2 is the front view thereof;

FIG. 3 is the rear view thereof;

FIG. 4 is the left-side view thereof;

FIG. 5 is the right-side view thereof;

FIG. 6 is the top view thereof;

FIG. 7 is the bottom view thereof;

FIG. 8 is the rear perspective view thereof; and,

FIG. 9 is the partially enlarged view of the encircled portion in FIG. 1.

The broken lines in the figures depict environmental subject matter and form no part of the claimed design. The dot-dash lines in the figures represent an unclaimed boundary line and form no part of the claimed design. The dot-dot-dash broken lines encircling portions of the claimed design that are illustrated in enlargements form no part of the claimed design.

1 Claim, 7 Drawing Sheets

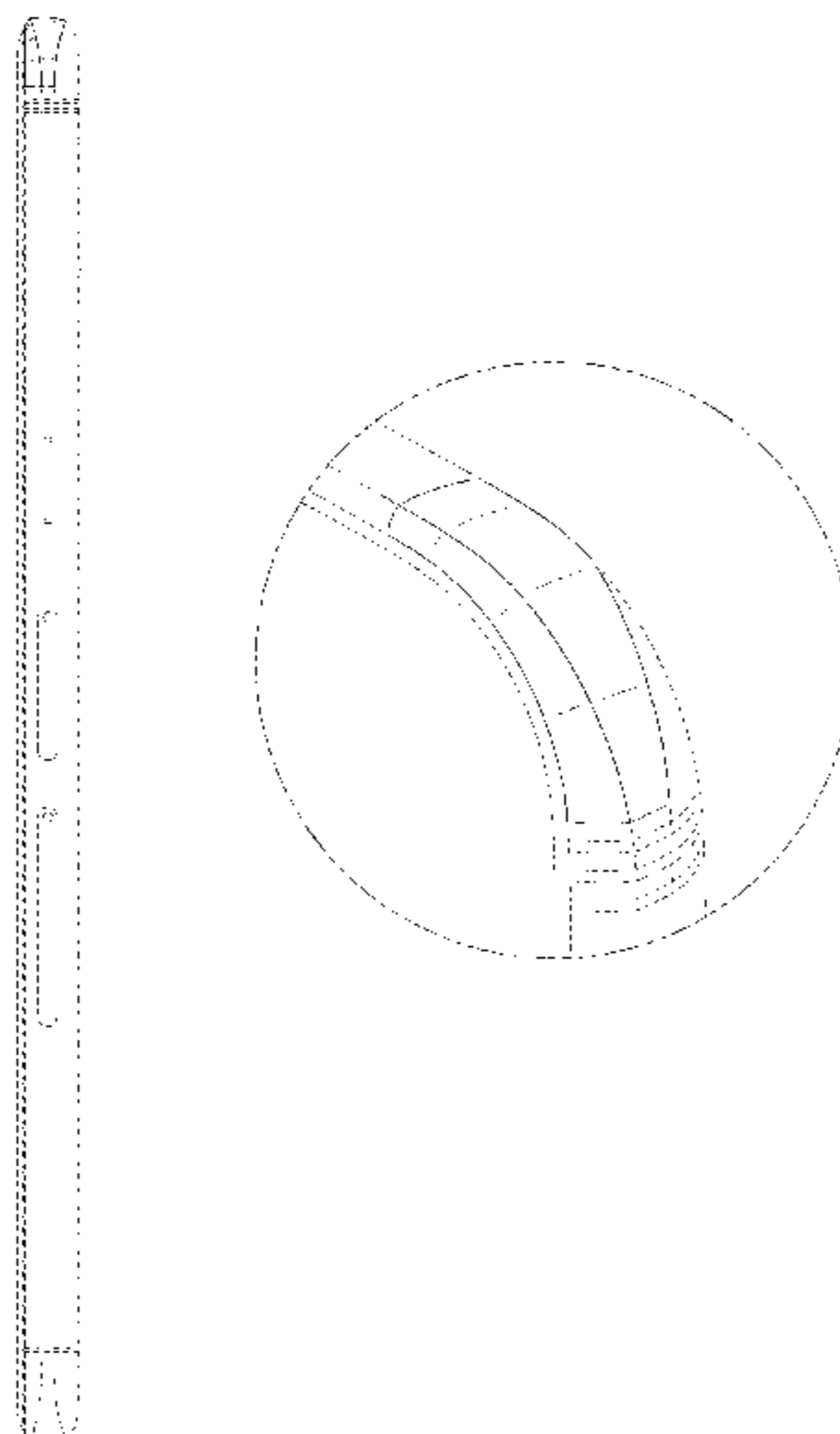

(56)

References Cited

U.S. PATENT DOCUMENTS

D696,640	S	*	12/2013	Park	D14/138	G
D697,889	S	*	1/2014	Ahn	D14/138	G
D700,162	S	*	2/2014	Takahashi	D14/138	G
D701,192	S	*	3/2014	Park	D14/138	G
D701,851	S	*	4/2014	Bae	D14/138	G
D714,241	S	*	9/2014	Kanayama	D14/138	G
D714,242	S	*	9/2014	Kanayama	D14/138	G
D720,731	S	*	1/2015	Ahn	D14/248	
D723,495	S	*	3/2015	Jeong	D14/138	G
D731,481	S		6/2015	Akana et al.			
D732,498	S		6/2015	Huang et al.			
D777,699	S	*	1/2017	Yuan	D14/138	G
D780,710	S	*	3/2017	Song	D14/138	G
D784,946	S	*	4/2017	Jun	D14/138	AA
D791,097	S	*	7/2017	Park	D14/138	G
D791,099	S	*	7/2017	Park	D14/138	G
D793,354	S	*	8/2017	Li	D14/138	G
D801,297	S	*	10/2017	Song	D14/138	G
D801,322	S	*	10/2017	Song	D14/248	

OTHER PUBLICATIONS

Samsung Galaxy C9 Pro officially unveiled as the manufacturer's first phone with 6GB of RAM, Oct. 21, 2016, [online], [site visited

Jun. 27, 2017]. Retrieved from url:http://www.phonearena.com/news/Samsung-Galaxy-C9-Pro-officially-unveiled-as-the-manufacturers-first-phone-with-6GB-of-RAM_id86873 (Year: 2016).*

Samsung Galaxy C7, Jun. 2017, [online], [site visited Apr. 23, 2018]. Retrieved from url:https://www.gsmarena.com/samsung_galaxy_c7-pictures-8046.php (Year: 2017).*

Samsung Galaxy C5, Jun. 2016, [online], [site visited Apr. 23, 2018]. Retrieved from url:https://www.gsmarena.com/samsung_galaxy_c5-pictures-8047.php (Year: 2016).*

OnePlus 3, Jun. 2016, [online], [site visited Apr. 27, 2018]. Retrieved from url:https://www.gsmarena.com/oneplus_3-pictures-7995.php (Year: 2016).*

Huawei "Huawei Mate S" [2016] www.consumer.huawei.com Dec. 6, 2016 <<http://consumer.huawei.com/en/mobile-phones/mateS/index.htm>>.

Lorga, Radu "Lenovo Phab2 Comes to India, Will Go on Sale on Dec. 9, Priced at \$175" [2016] www.gsmdome.com Dec. 6, 2016 <<http://www.gsmdome.com/lenovo-phab2-comes-india-will-go-sale-december-9th-priced-175>>.

Rob "iPhone 6 vs iPhone 6 Plus: which to buy?" [2014] www.isource.com Sep. 9, 2014 <<http://isource.com/2014/09/09/iphone-6-vs-iphone-6-plus/>>.

* cited by examiner

FIG. 1

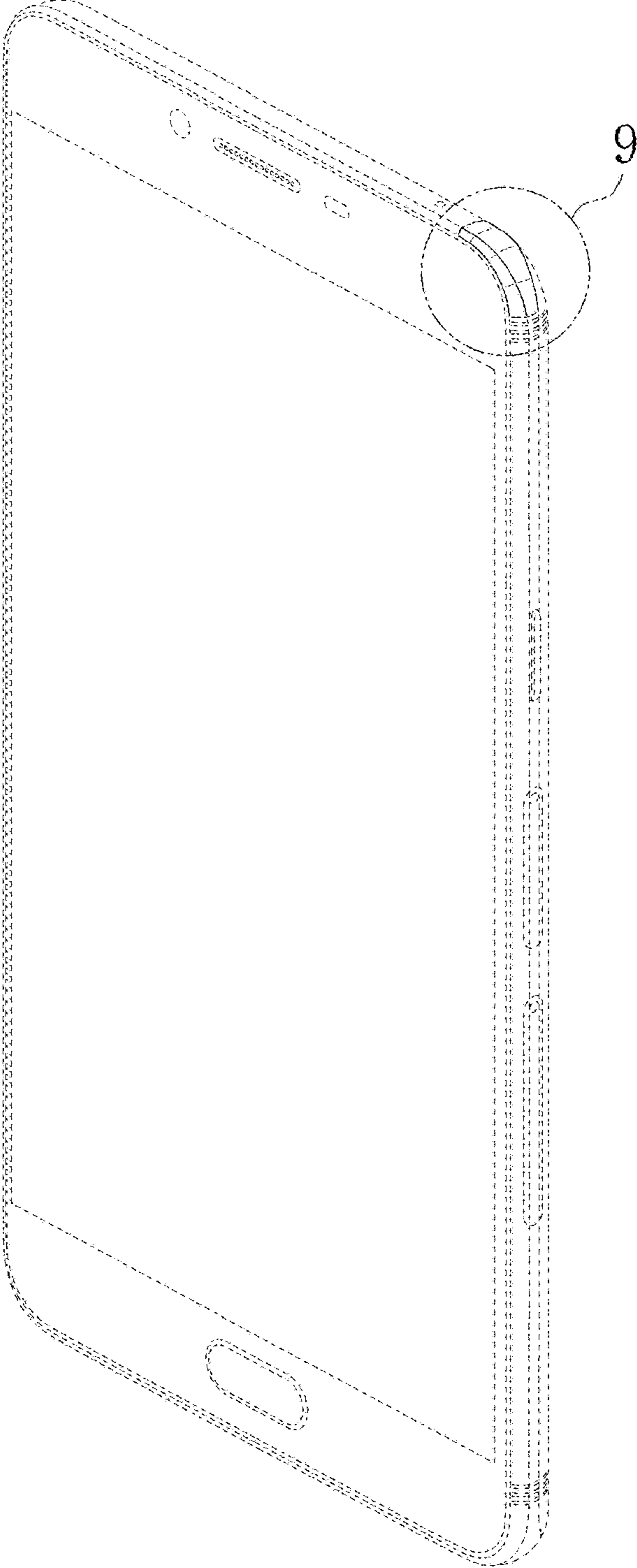

FIG. 2

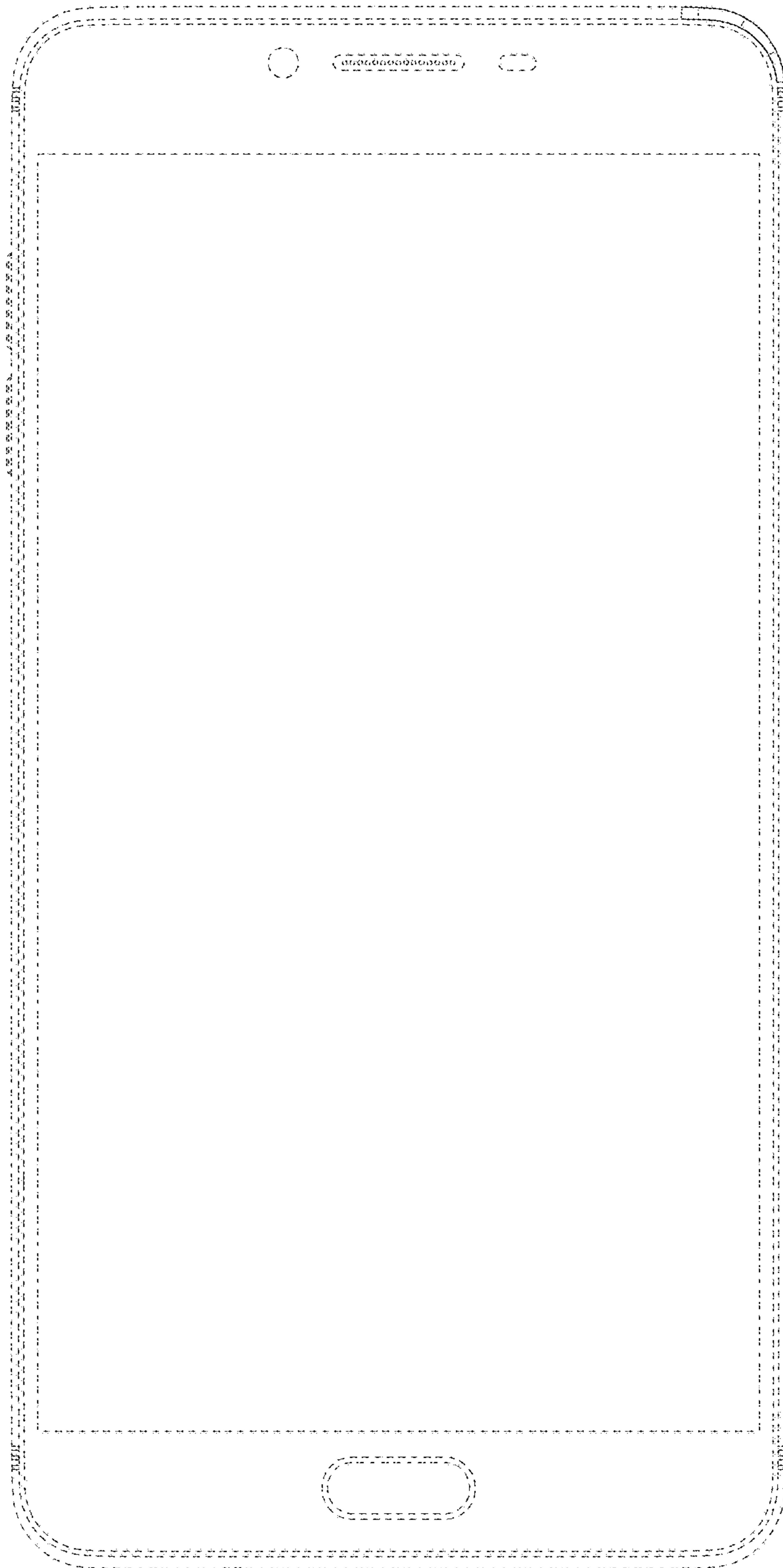

FIG. 3

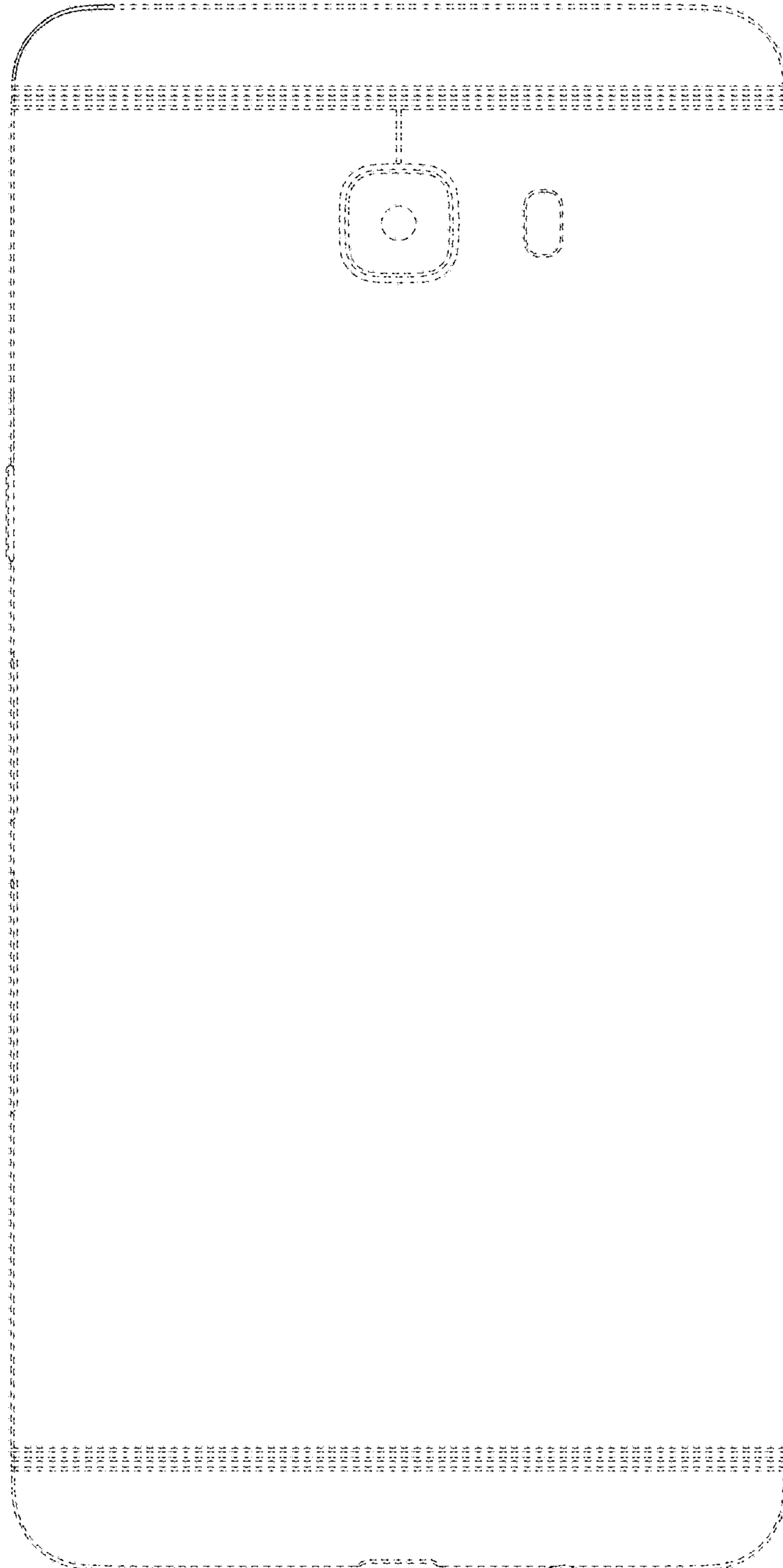

FIG. 4

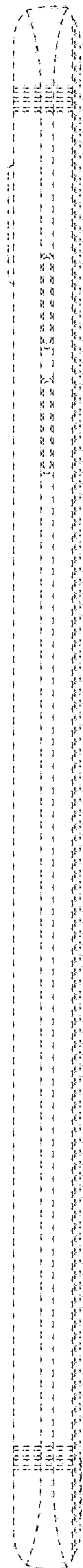

FIG. 5

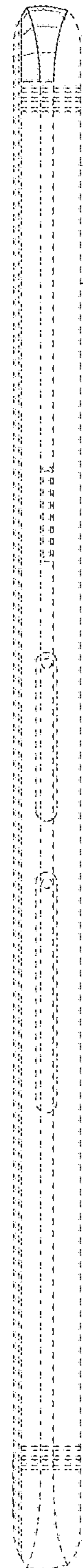

FIG. 6

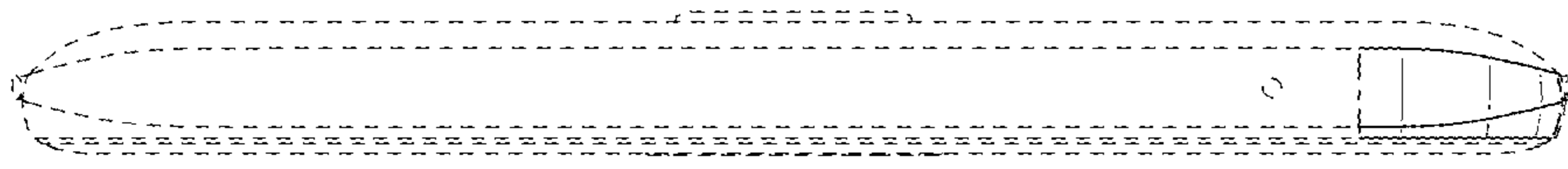

FIG. 7

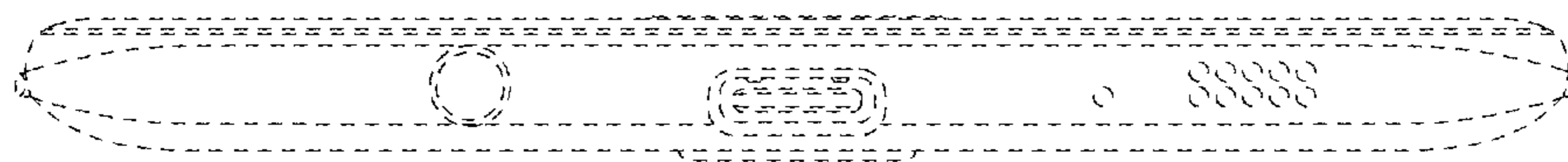

FIG. 8

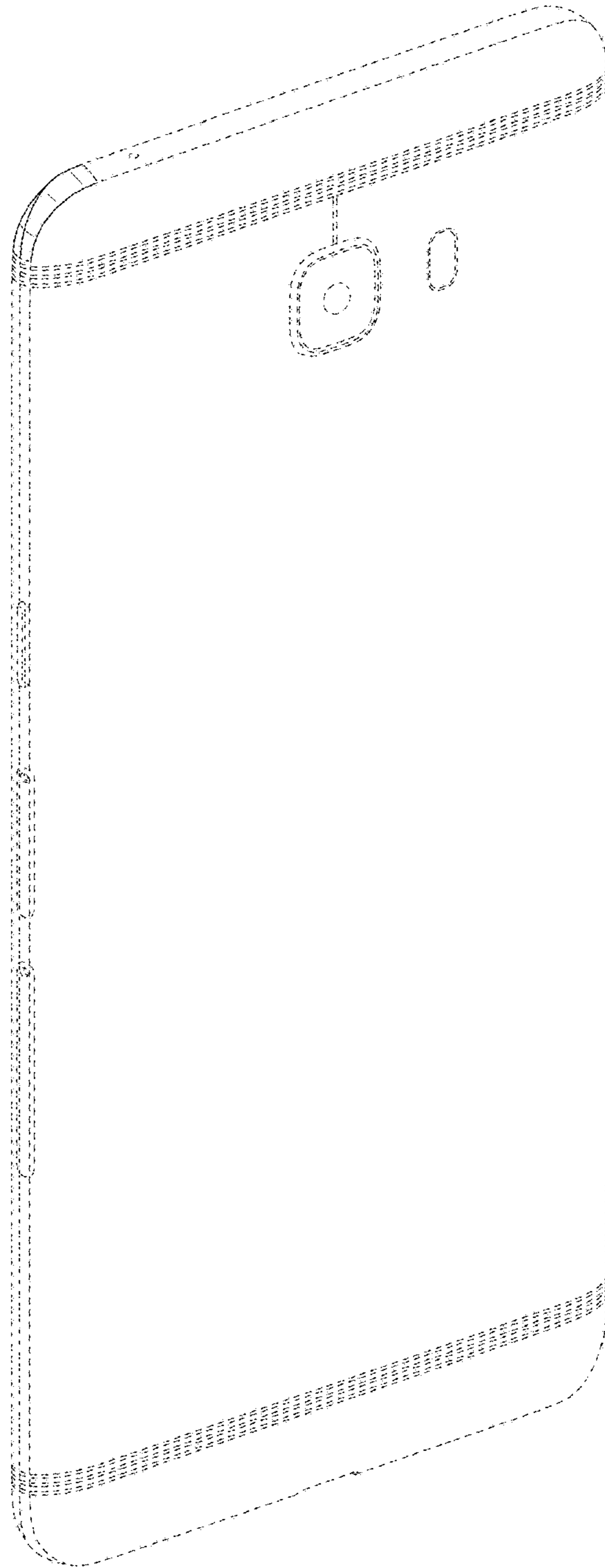

FIG. 9

