



US00D829682S

(12) **United States Design Patent** (10) **Patent No.:** **US D829,682 S**  
**Han et al.** (45) **Date of Patent:** **\*\* Oct. 2, 2018**

(54) **MOBILE PHONE**

(74) *Attorney, Agent, or Firm* — Birch, Stewart, Kolasch & Birch, LLP

(71) Applicant: **LG ELECTRONICS INC.**, Seoul (KR)

(57) **CLAIM**

(72) Inventors: **Jongbeom Han**, Seoul (KR); **Haklim Lee**, Seoul (KR)

The ornamental design for a mobile phone, as shown and described.

(73) Assignee: **LG ELECTRONICS INC.**, Seoul (KR)

**DESCRIPTION**

(\*\*) Term: **15 Years**

- 1. Mobile phone
- 1.1 : Perspective
- 1.2 : Front
- 1.3 : Back
- 1.4 : Left
- 1.5 : Right
- 1.6 : Top
- 1.7 : Back perspective
- 1.8 : Perspective view 2
- 1.9 : Front view 2
- 1.10 : Back view 2
- 1.11 : Left view 2
- 1.12 : Top view 2
- 1.13 : Back perspective view 2

(21) Appl. No.: **35/503,375**

(22) Filed: **Jan. 11, 2017**

(80) **Hague Agreement Data**

Int. Filing Date: **Jan. 11, 2017**  
 Int. Reg. No.: **DM/094392**  
 Int. Reg. Date: **Jan. 11, 2017**  
 Int. Reg. Pub. Date: **Jul. 14, 2017**

The broken lines depict portions of the mobile phone that form no part of the claimed design; the dash-dot broken lines define the boundary of the claimed design and form no part thereof; the reproduction **1.1** is a front perspective view of the mobile phone; the reproduction **1.2** is a front view thereof; the reproduction **1.3** is a back view thereof; the reproduction **1.4** is a left view thereof; the reproduction **1.5** is a right view thereof; the reproduction **1.6** is a top view thereof where the bottom view is a mirror image; the reproduction **1.7** is a back perspective view thereof; the reproduction **1.8** is a front perspective view in a condition that the subject design has been unfolded; the reproduction **1.9** is a front view of the reproduction **1.8**; the reproduction **1.10** is a back view of the reproduction **1.8**; the reproduction **1.11** is a left view of the reproduction **1.8** where the right view is a mirror image; the reproduction **1.12** is a top view of the reproduction **1.8** where the bottom view is a mirror image; the reproduction **1.13** is a back perspective view of the reproduction **1.8**.

(30) **Foreign Application Priority Data**

Jul. 11, 2016 (KR) ..... 30-2016-0033671

(51) **LOC (11) Cl.** ..... **14-03**

(52) **U.S. Cl.**  
USPC ..... **D14/138 AB**

(58) **Field of Classification Search**  
USPC ..... D14/138 AA, 138 AB, 138 AC, 138 AD, D14/138 C, 138 G, 138 R, 248, 315-318,  
(Continued)

(56) **References Cited**

U.S. PATENT DOCUMENTS

7,408,698 B2 \* 8/2008 Kuo ..... G06F 1/1601  
204/450  
D588,126 S \* 3/2009 Chiang ..... D14/345  
(Continued)

*Primary Examiner* — Richard E Chilcot

**1 Claim, 13 Drawing Sheets**

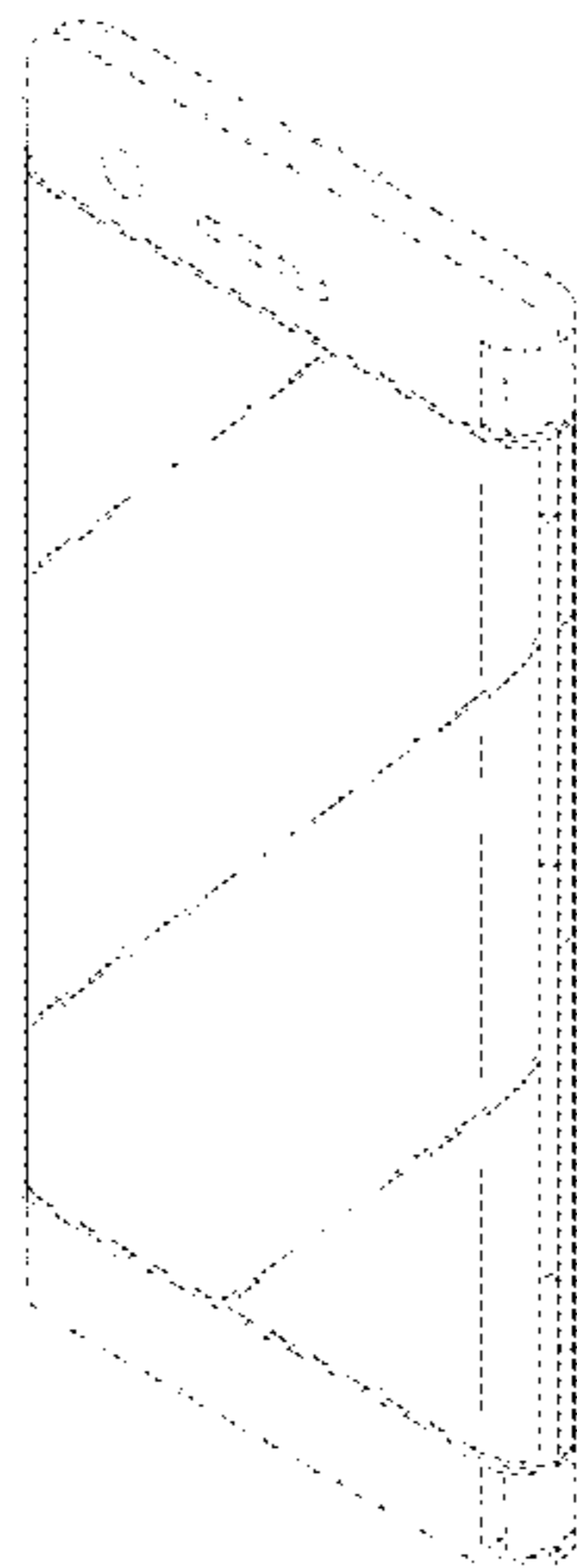

(52) **U.S. Cl.**  
 CPC ..... *G06F 1/1616* (2013.01)

(58) **Field of Classification Search**  
 USPC ..... D14/341, 342, 345, 346, 203.1, 203.3,  
 D14/203.7, 218, 250  
 CPC .. G06F 1/1652; G06F 1/1616; H04M 1/0214;  
 H04M 1/0218; H04M 1/0268; H04M  
 1/027; H04M 1/0202; H04M 1/0279;  
 H04M 1/0235; H04M 1/0237; H04M  
 1/0239; H04M 1/0266; H04M 1/0295  
 See application file for complete search history.

(56) **References Cited**

U.S. PATENT DOCUMENTS

D681,000 S \* 4/2013 Koh ..... D14/203.4  
 D681,054 S \* 4/2013 Koh ..... D14/496  
 D689,054 S \* 9/2013 Snyder ..... D14/440  
 D693,323 S \* 11/2013 Kawase ..... D14/138 AB  
 D716,253 S \* 10/2014 Lee ..... D14/138 AB  
 D716,751 S \* 11/2014 Lee ..... D14/138 AB  
 D716,800 S \* 11/2014 Lee ..... D14/345

D742,873 S \* 11/2015 Ahn ..... D14/341  
 D746,285 S \* 12/2015 Okabe ..... D14/345  
 9,239,594 B2 \* 1/2016 Lee ..... G06F 1/1652  
 D749,573 S \* 2/2016 Park ..... D14/203.4  
 D749,575 S \* 2/2016 Park ..... D14/203.4  
 D749,576 S \* 2/2016 Park ..... D14/203.4  
 D754,657 S \* 4/2016 Kim ..... D14/345  
 D767,525 S \* 9/2016 Byun ..... D14/138 AB  
 D767,526 S \* 9/2016 Lee ..... D14/138 AB  
 D769,209 S \* 10/2016 Byun ..... D14/138 AB  
 D778,866 S \* 2/2017 Lee ..... D14/138 AB  
 D782,436 S \* 3/2017 Kwak ..... D14/138 AB  
 D784,945 S \* 4/2017 Choo ..... D14/138 AB  
 D786,210 S \* 5/2017 Lee ..... D14/138 AB  
 D788,774 S \* 6/2017 Seo ..... D14/345  
 D791,725 S \* 7/2017 Lee ..... D14/138 AB  
 D791,726 S \* 7/2017 Lee ..... D14/138 AB  
 D795,826 S \* 8/2017 Yoon ..... D14/138 AB  
 D797,729 S \* 9/2017 Park ..... D14/248  
 D798,257 S \* 9/2017 Choo ..... D14/138 AB  
 D800,112 S \* 10/2017 Park ..... D14/345  
 D815,055 S \* 4/2018 Seo ..... D14/138 AB  
 2012/0044620 A1 \* 2/2012 Song ..... G06F 1/1616  
 361/679.01

\* cited by examiner

1.1

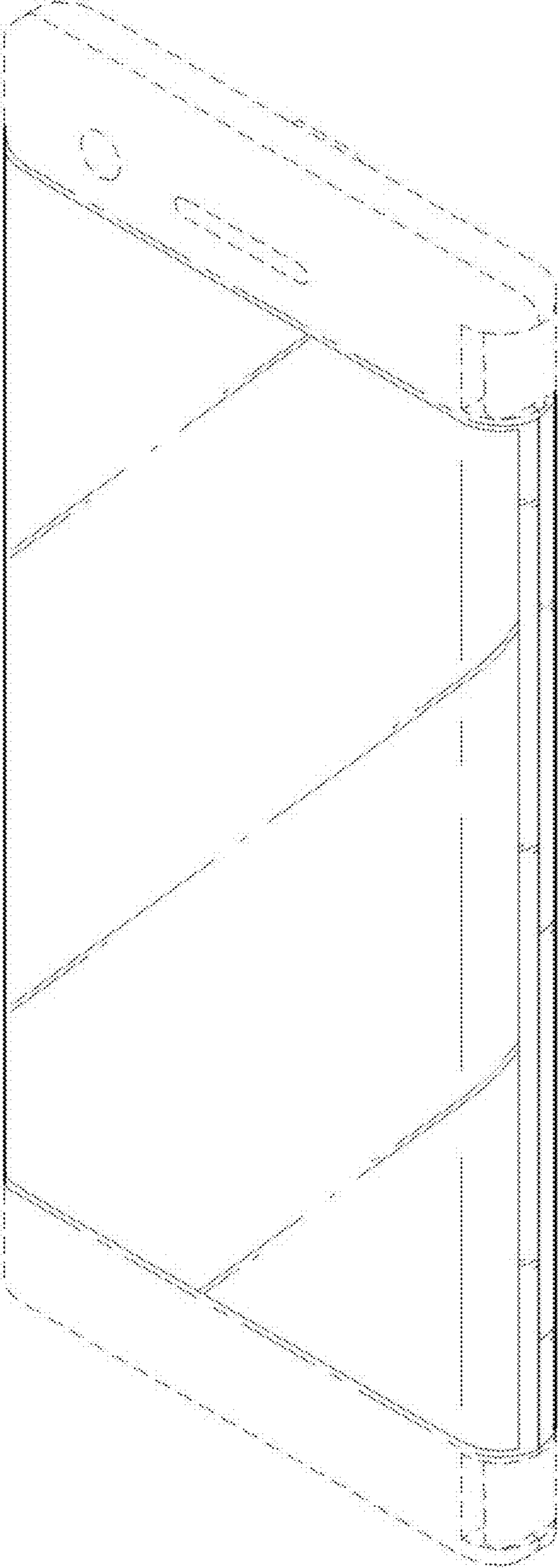

1.2

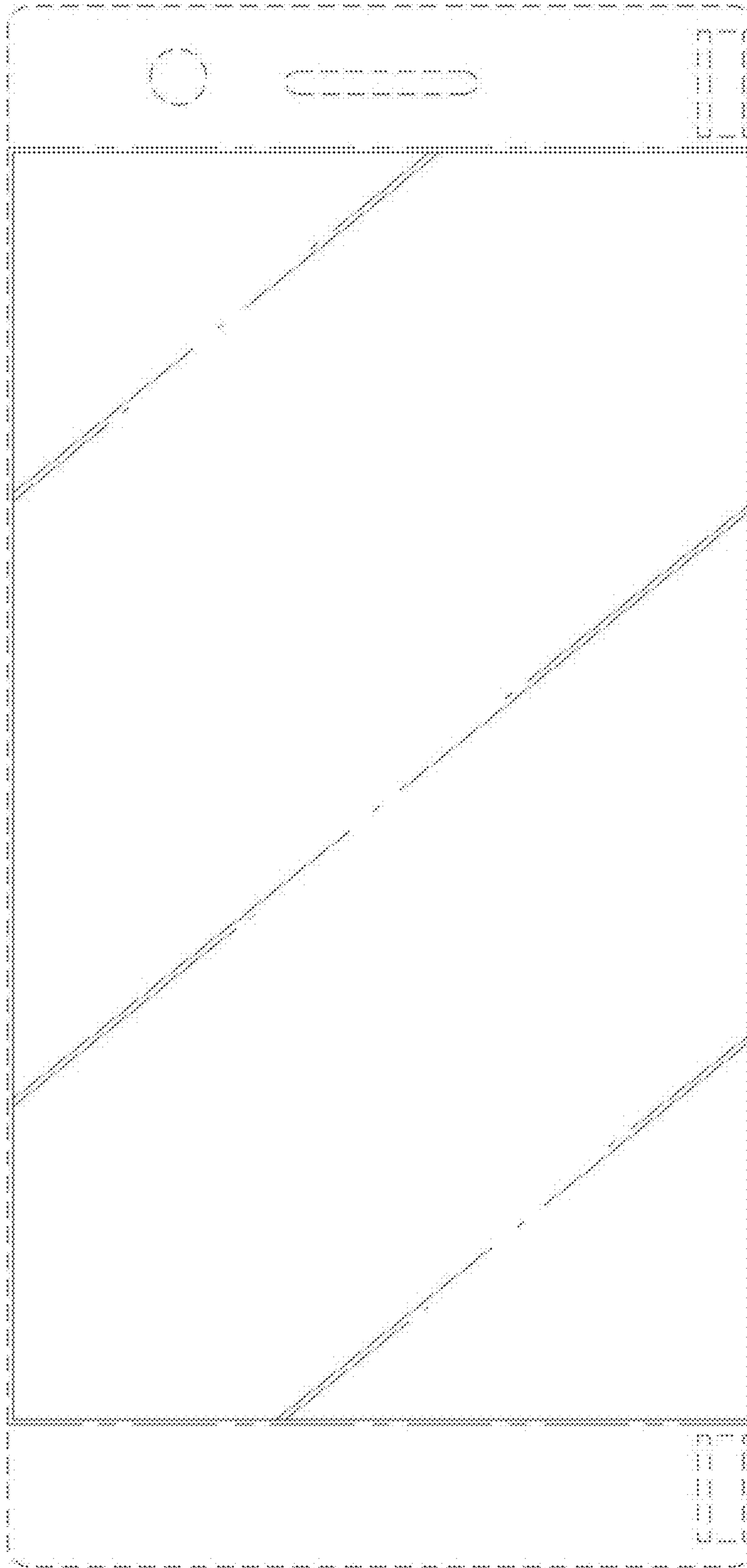

1.3

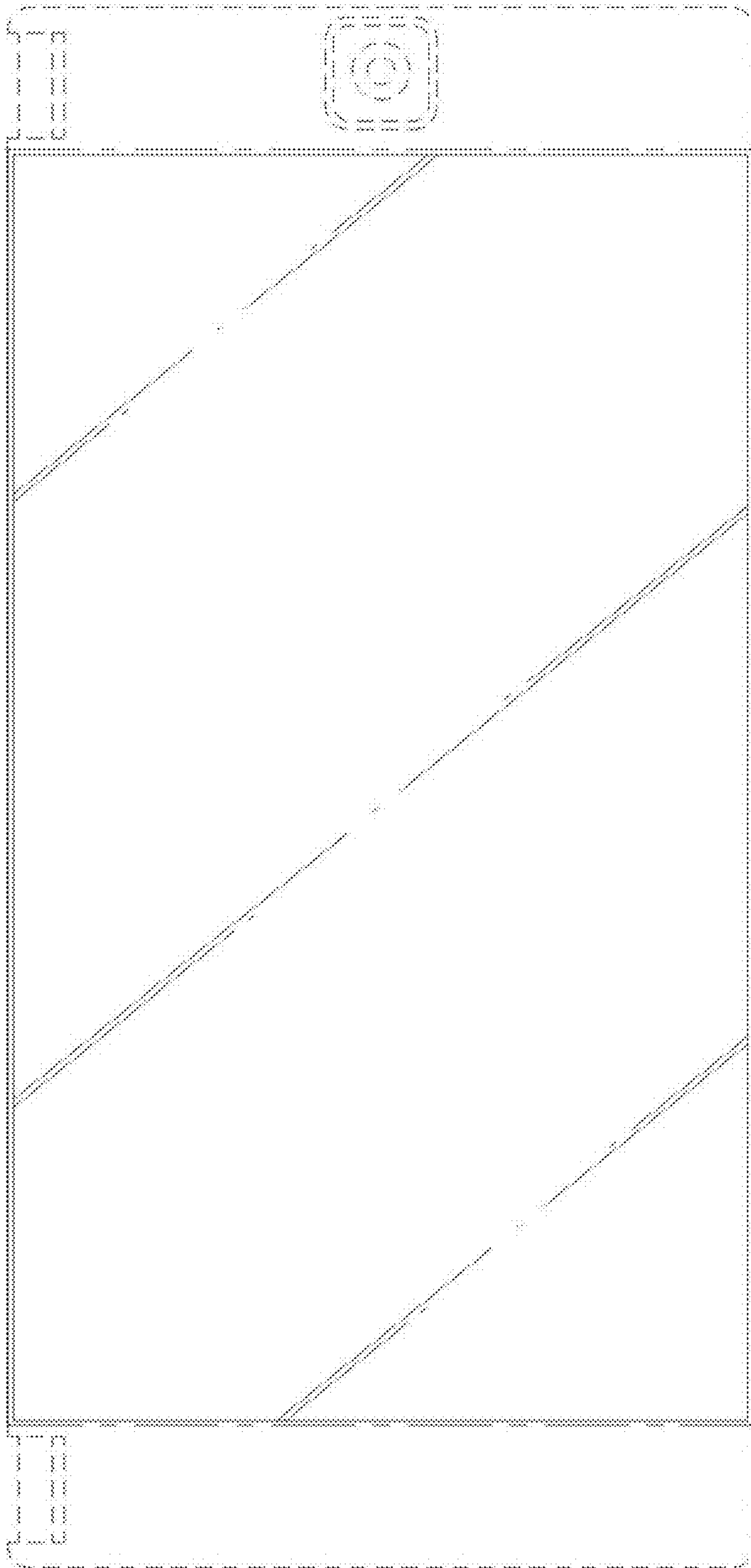

1.4

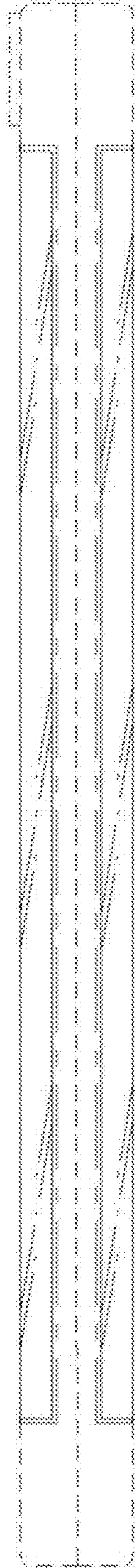

1.5

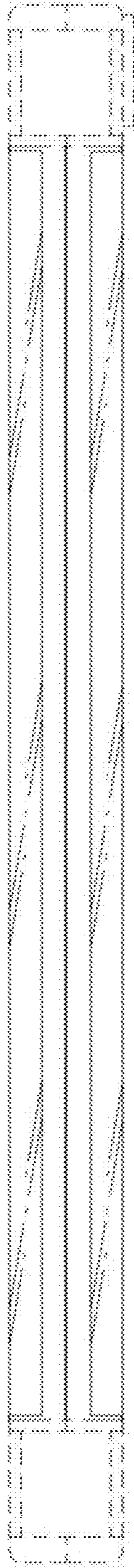

**1.6**

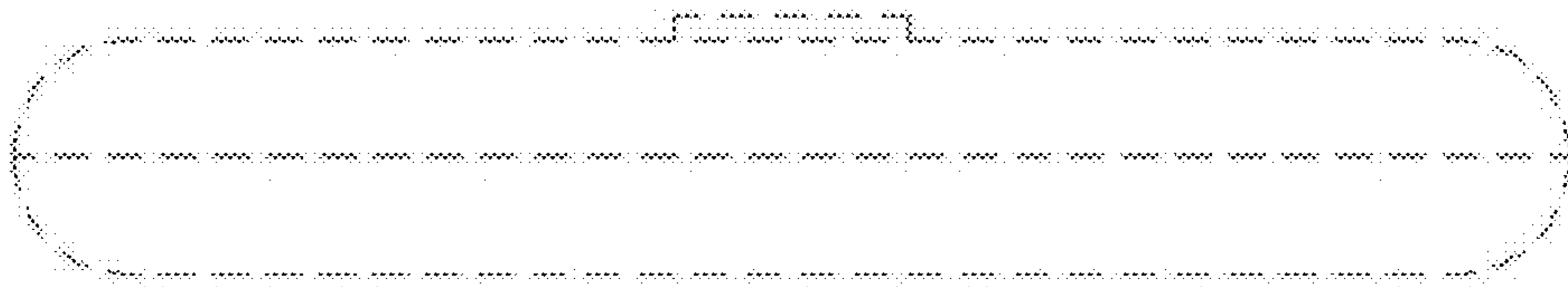



1.7

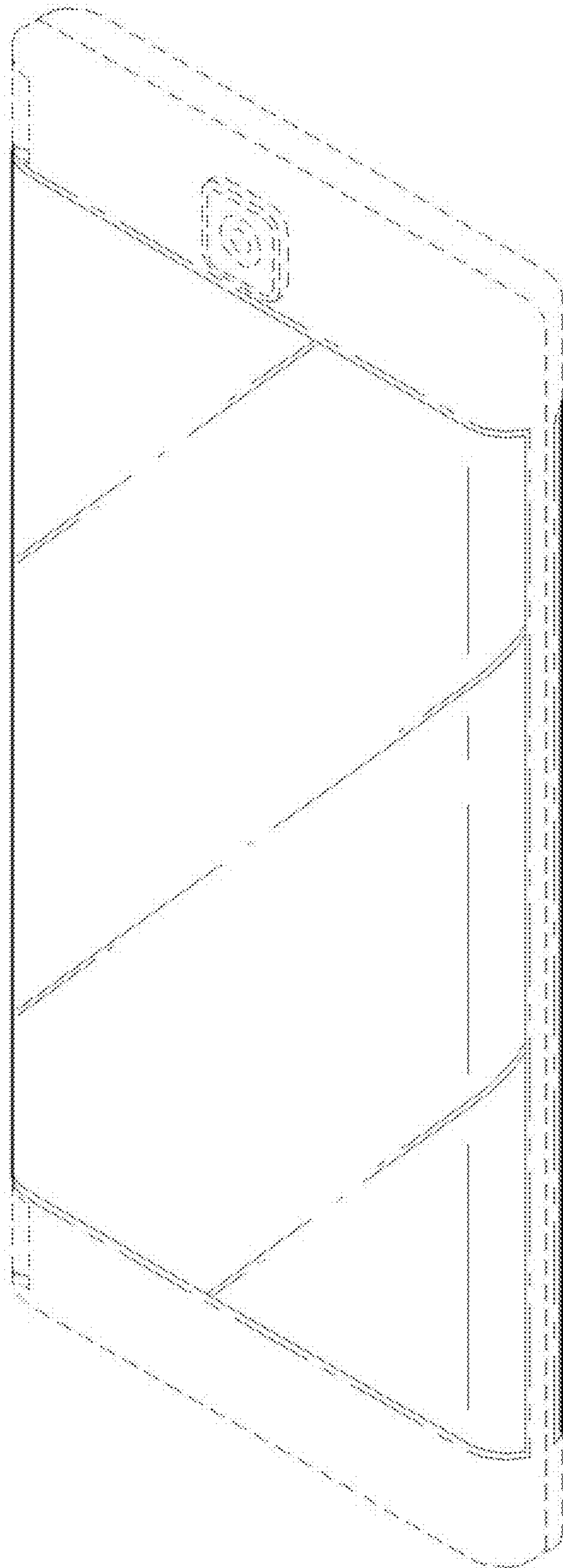

1.8

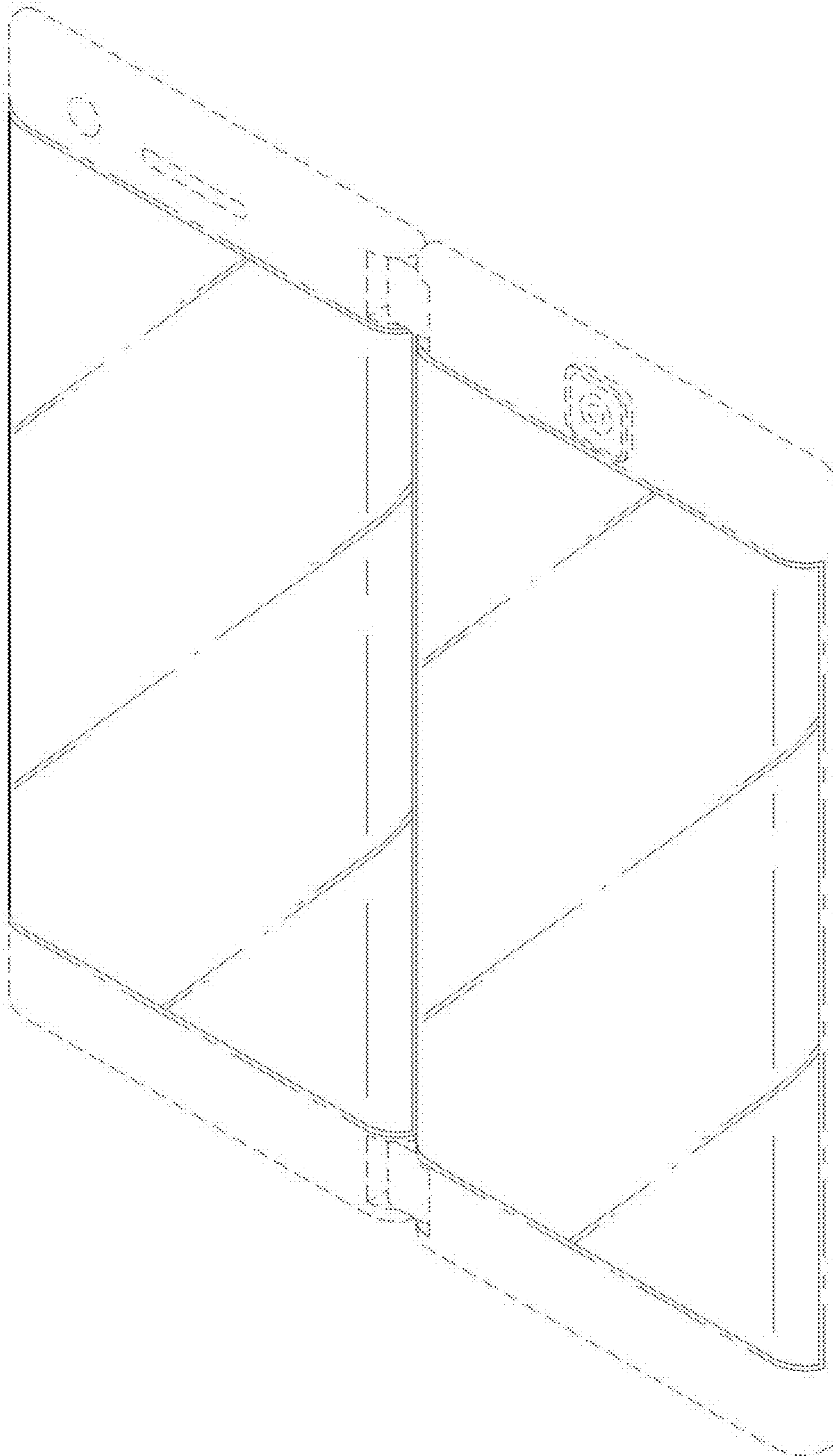

1.9

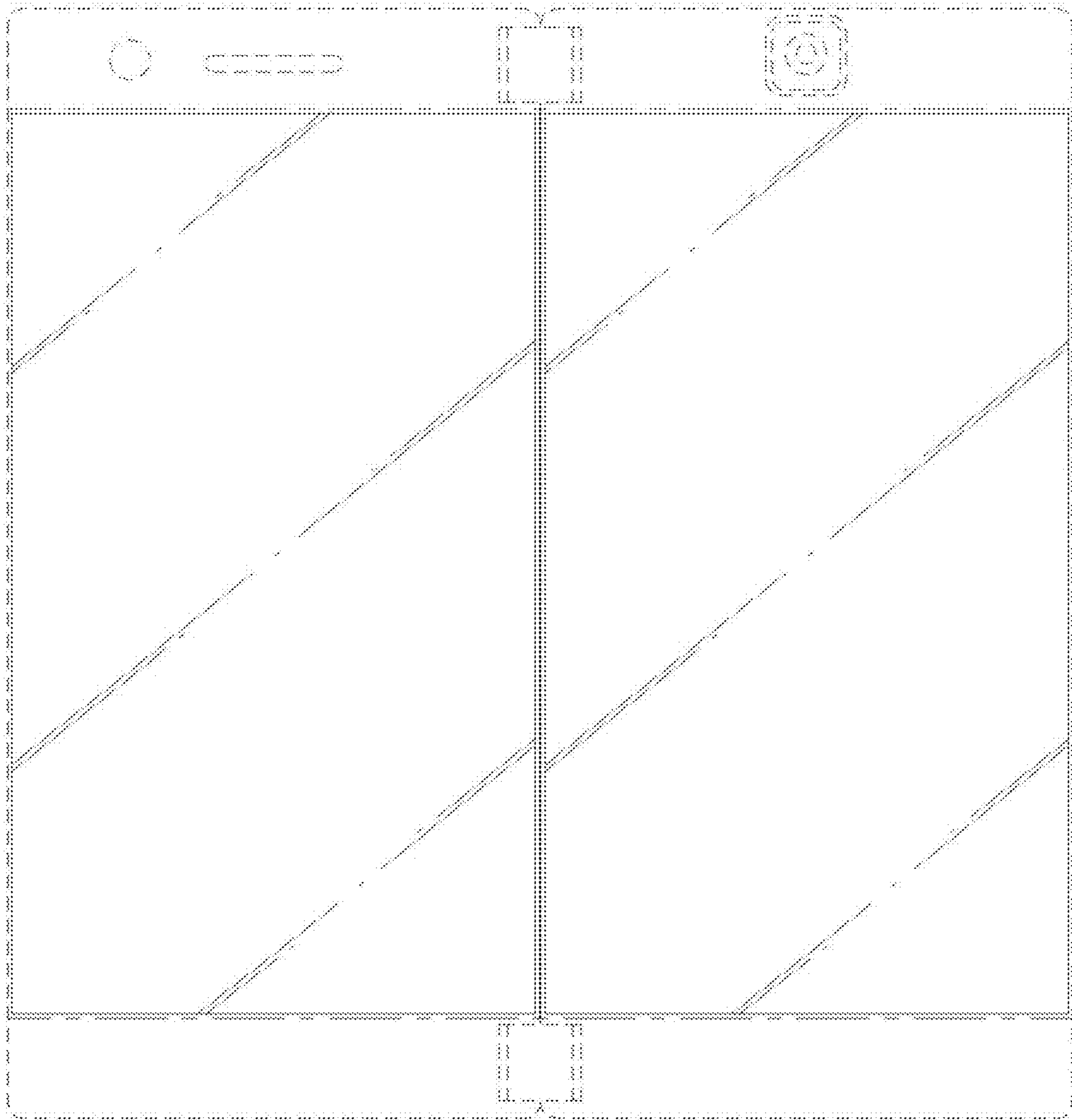

**1.10**

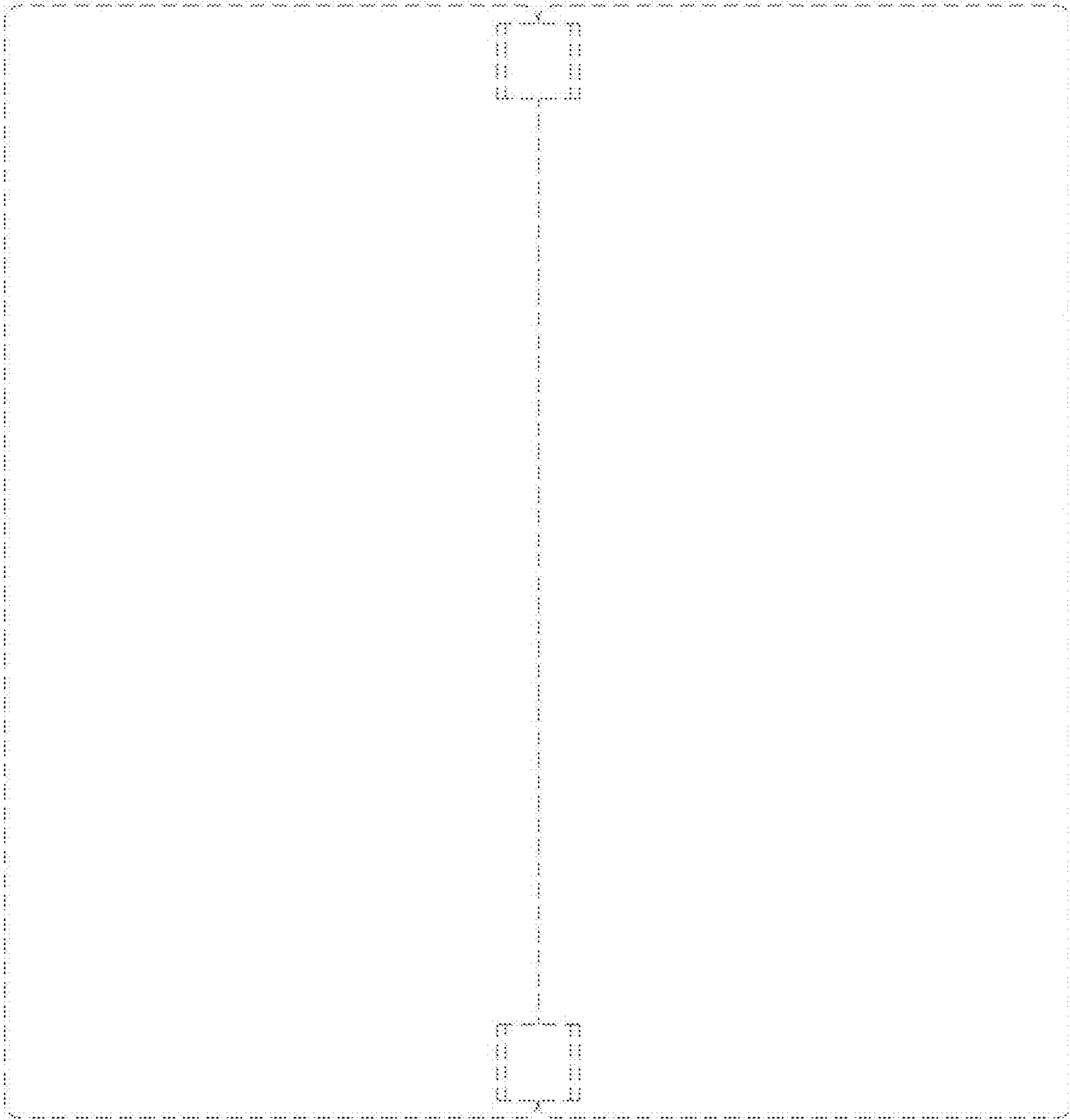

**1.11**

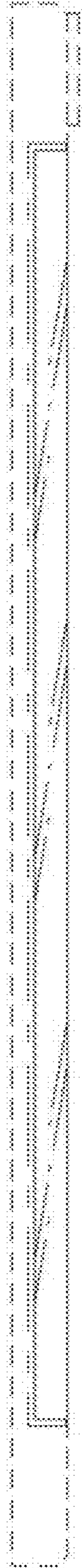

**1.12**

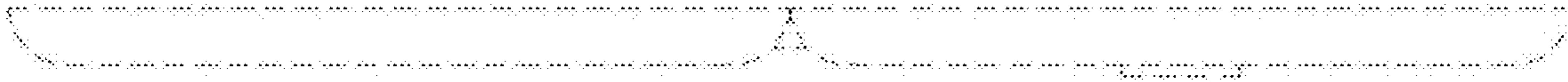

1.13

