



US00D829680S

(12) **United States Design Patent** (10) **Patent No.:** **US D829,680 S**
Han et al. (45) **Date of Patent:** **** Oct. 2, 2018**

(54) **MOBILE PHONE**

Primary Examiner — Richard E Chilcot

(71) Applicant: **LG ELECTRONICS INC.**, Seoul (KR)

(74) *Attorney, Agent, or Firm* — Birch, Stewart, Kolasch & Birch, LLP

(72) Inventors: **Jongbeom Han**, Seoul (KR); **Haklim Lee**, Seoul (KR)

(57) **CLAIM**

The ornamental design for a mobile phone, as shown and described.

(73) Assignee: **LG ELECTRONICS INC.**, Seoul (KR)

DESCRIPTION

(**) Term: **15 Years**

1. Mobile Phone

(21) Appl. No.: **35/503,331**

1.1 : Perspective

1.2 : Front

(22) Filed: **Jan. 11, 2017**

1.3 : Back

1.4 : Left

(80) **Hague Agreement Data**

Int. Filing Date: **Jan. 11, 2017**

Int. Reg. No.: **DM/094399**

Int. Reg. Date: **Jan. 11, 2017**

Int. Reg. Pub. Date: **Jul. 14, 2017**

1.5 : Right

1.6 : Top

1.7 : Back perspective

1.8 : Perspective view 2

1.9 : Front view 2

1.10 : Back view 2

1.11 : Left view 2

1.12 : Top view 2

1.13 : Back perspective view 2

(30) **Foreign Application Priority Data**

Jul. 11, 2016 (KR) 30-2016-0033670

(51) **LOC (11) Cl.** **14-03**

(52) **U.S. Cl.**
USPC **D14/138 AB**

(58) **Field of Classification Search**
USPC D14/138 AA, 138 AB, 138 AC, 138 AD,
D14/138 C, 138 G, 138 R, 248, 315–318,
(Continued)

The broken lines depict portions of the mobile phone that form no part of the claimed design; the reproduction 1.1 is a front perspective view of the mobile phone; the reproduction 1.2 is a front view thereof; the reproduction 1.3 is a back view thereof; the reproduction 1.4 is a left view thereof; the reproduction 1.5 is a right view thereof; the reproduction 1.6 is a top view thereof where the bottom view is a mirror image; the reproduction 1.7 is a back perspective view thereof; the reproduction 1.8 is a front perspective view in a condition that the subject design has been unfolded; the reproduction 1.9 is a front view of the reproduction 1.8; the reproduction 1.10 is a back view of the reproduction 1.8; the reproduction 1.11 is a left view of the reproduction 1.8 where the right view is a mirror image; the reproduction 1.12 is a top view of the reproduction 1.8 where the bottom view is a mirror image; the reproduction 1.13 is a back perspective view of the reproduction 1.8.

(56) **References Cited**

U.S. PATENT DOCUMENTS

7,408,698 B2 * 8/2008 Kuo G06F 1/1601
204/450

D588,126 S * 3/2009 Chiang D14/345
(Continued)

1 Claim, 13 Drawing Sheets

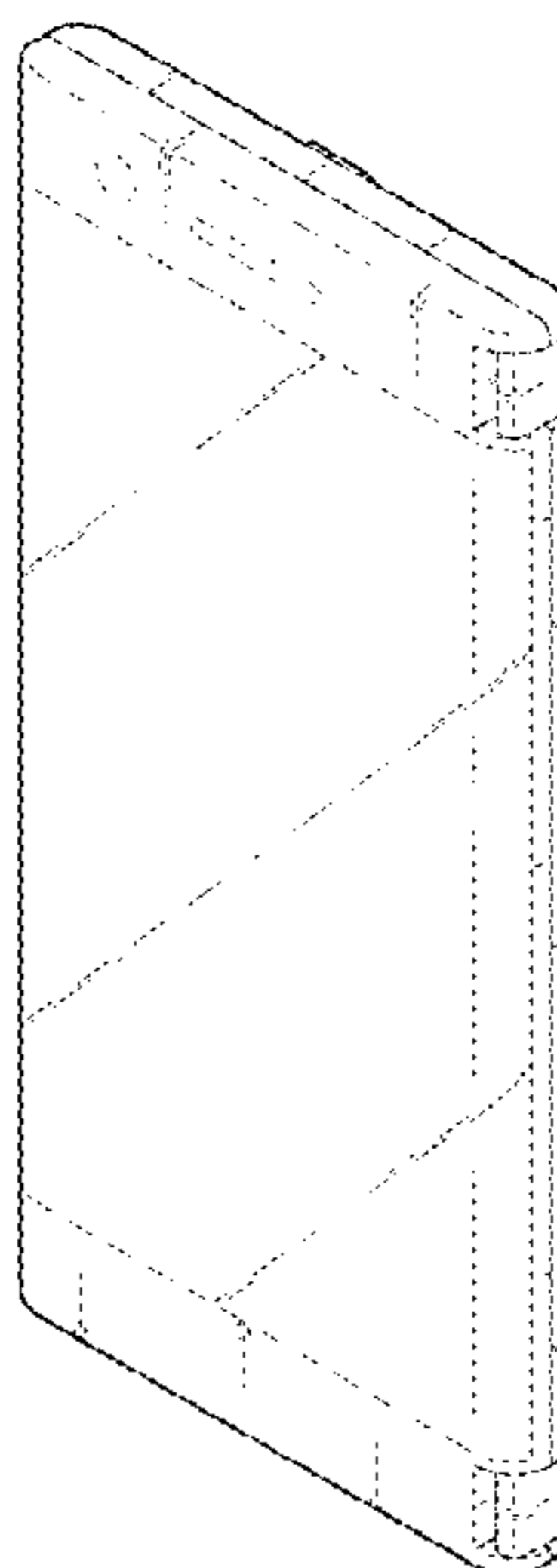

(52) **U.S. Cl.**
 CPC *G06F 1/1616* (2013.01)

(58) **Field of Classification Search**
 USPC D14/341, 342, 345, 346, 203.1, 203.3,
 D14/203.7, 218, 250
 CPC .. G06F 1/1652; G06F 1/1616; H04M 1/0214;
 H04M 1/0218; H04M 1/0268; H04M
 1/027; H04M 1/0202; H04M 1/0279;
 H04M 1/0235; H04M 1/0237; H04M
 1/0239; H04M 1/0266; H04M 1/0295
 See application file for complete search history.

(56) **References Cited**

U.S. PATENT DOCUMENTS

D681,000 S * 4/2013 Koh D14/203.4
 D681,054 S * 4/2013 Koh D14/496
 D689,054 S * 9/2013 Snyder D14/440
 D693,323 S * 11/2013 Kawase D14/138 AB
 D716,253 S * 10/2014 Lee D14/138 AB
 D716,751 S * 11/2014 Lee D14/138 AB
 D716,800 S * 11/2014 Lee D14/345

D742,873 S * 11/2015 Ahn D14/341
 D746,285 S * 12/2015 Okabe D14/345
 9,239,594 B2 * 1/2016 Lee G06F 1/1652
 D749,573 S * 2/2016 Park D14/203.4
 D749,575 S * 2/2016 Park D14/203.4
 D749,576 S * 2/2016 Park D14/203.4
 D754,657 S * 4/2016 Kim D14/345
 D767,525 S * 9/2016 Byun D14/138 AB
 D767,526 S * 9/2016 Lee D14/138 AB
 D769,209 S * 10/2016 Byun D14/138 AB
 D778,866 S * 2/2017 Lee D14/138 AB
 D782,436 S * 3/2017 Kwak D14/138 AB
 D784,945 S * 4/2017 Choo D14/138 AB
 D786,210 S * 5/2017 Lee D14/138 AB
 D788,774 S * 6/2017 Seo D14/345
 D791,725 S * 7/2017 Lee D14/138 AB
 D791,726 S * 7/2017 Lee D14/138 AB
 D795,826 S * 8/2017 Yoon D14/138 AB
 D797,729 S * 9/2017 Park D14/248
 D798,257 S * 9/2017 Choo D14/138 AB
 D800,112 S * 10/2017 Park D14/345
 D815,055 S * 4/2018 Seo D14/138 AB
 2012/0044620 A1 * 2/2012 Song G06F 1/1616
 361/679.01

* cited by examiner

1.1

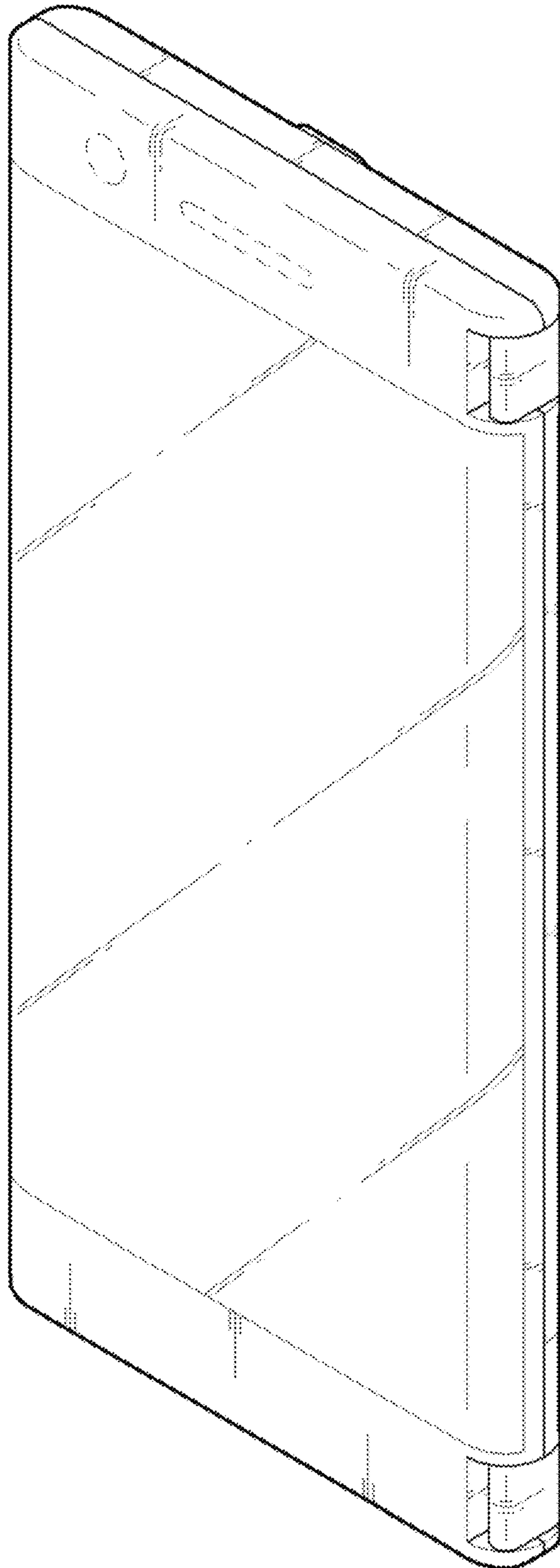

1.2

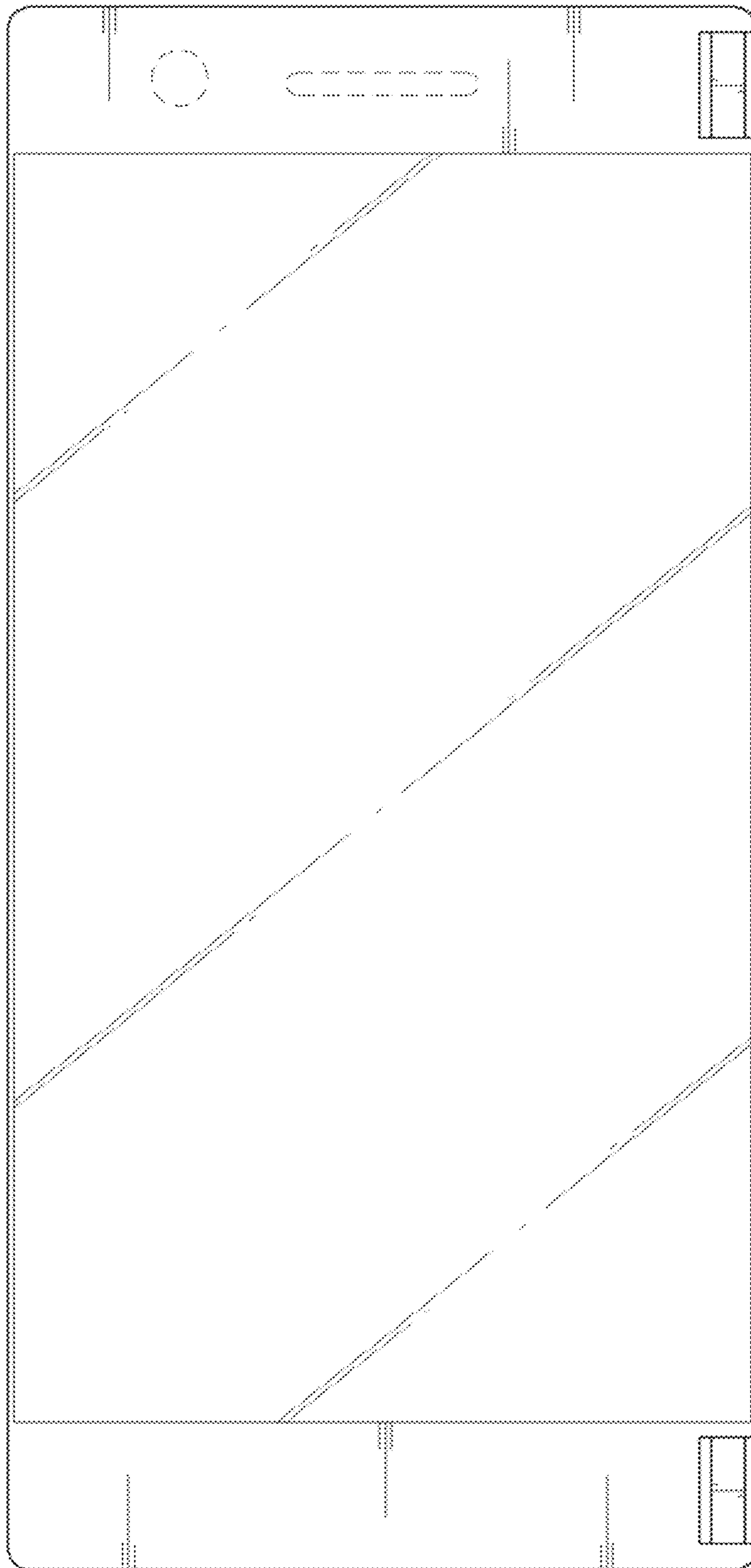

1.3

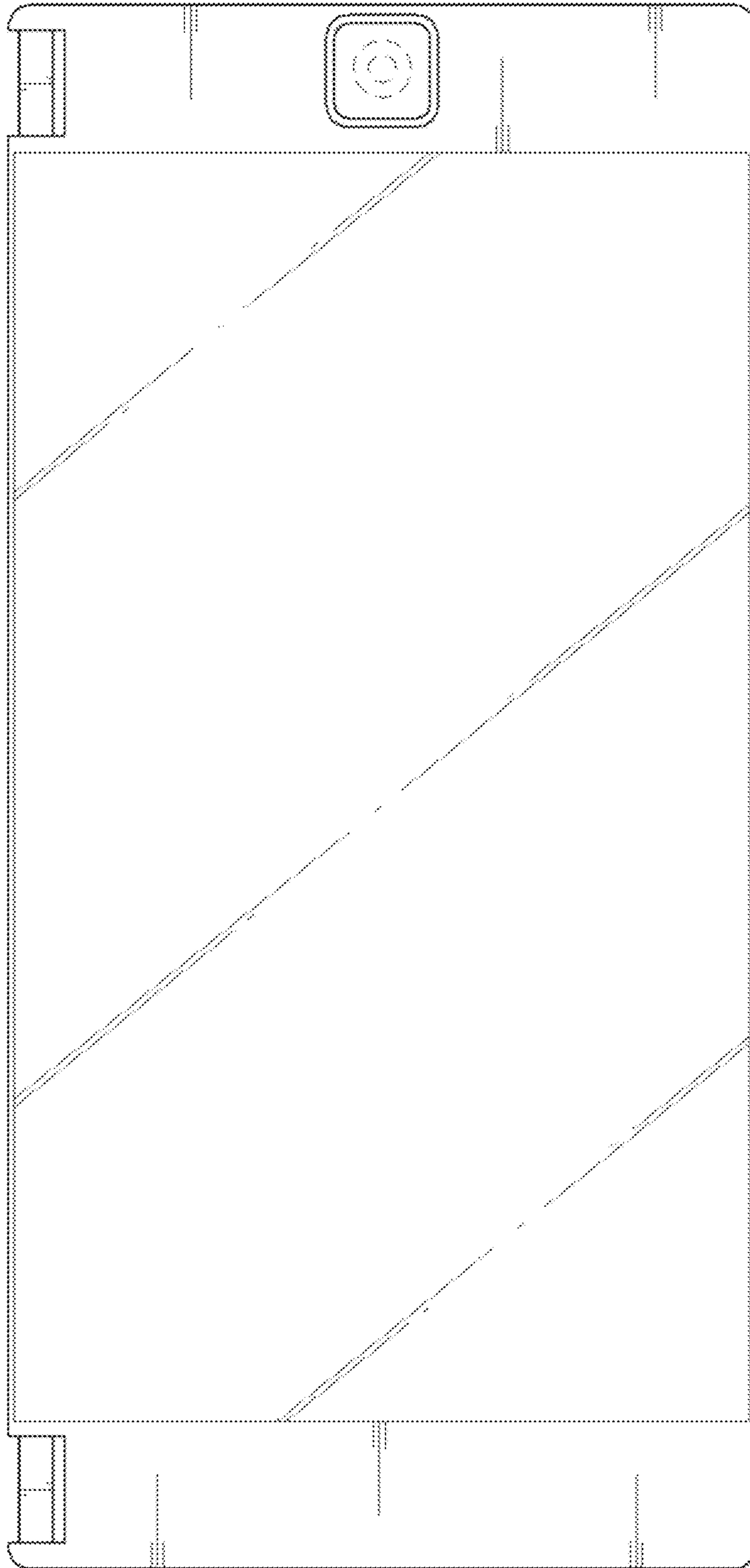

1.4

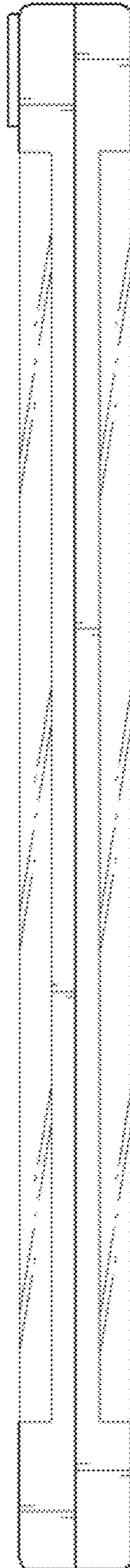

1.5

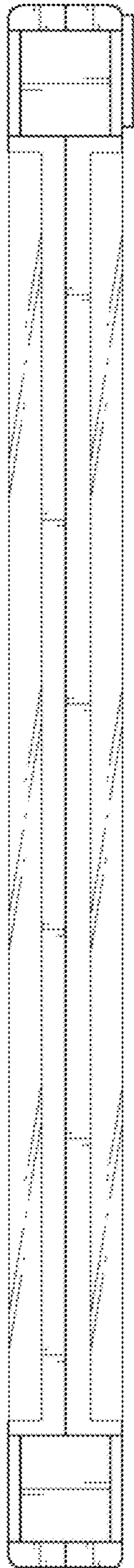

1.6

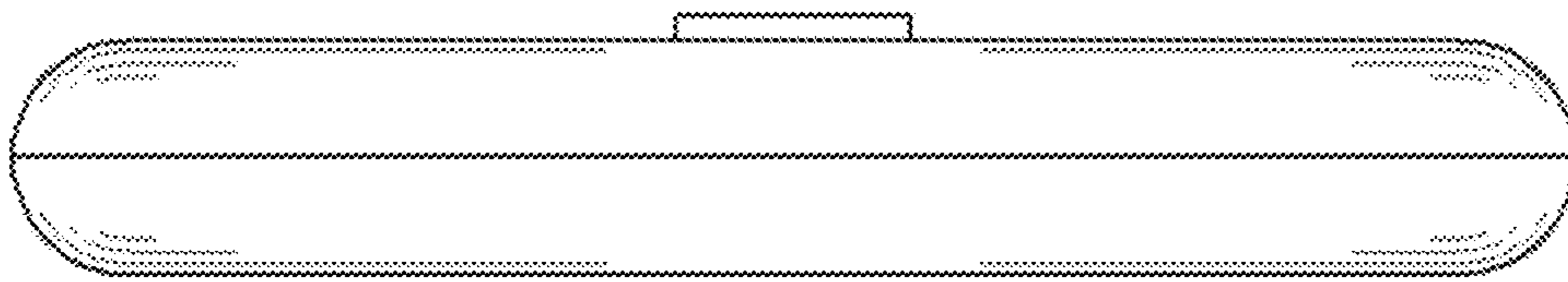

1.7

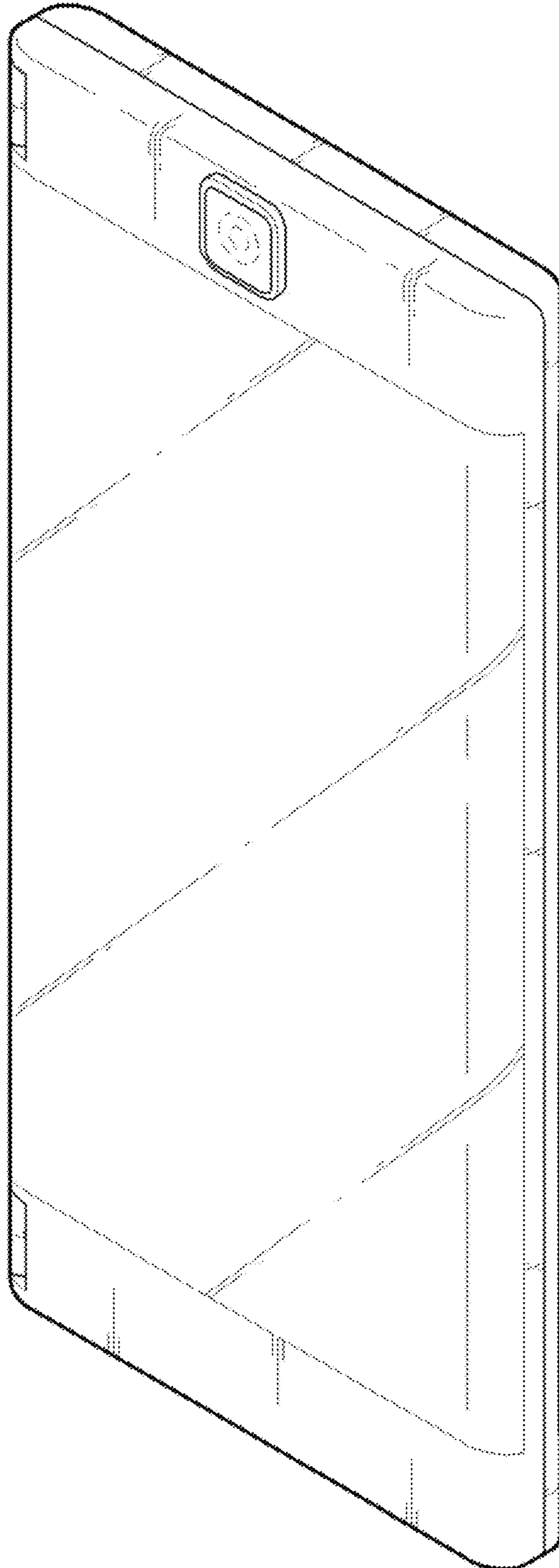

1.8

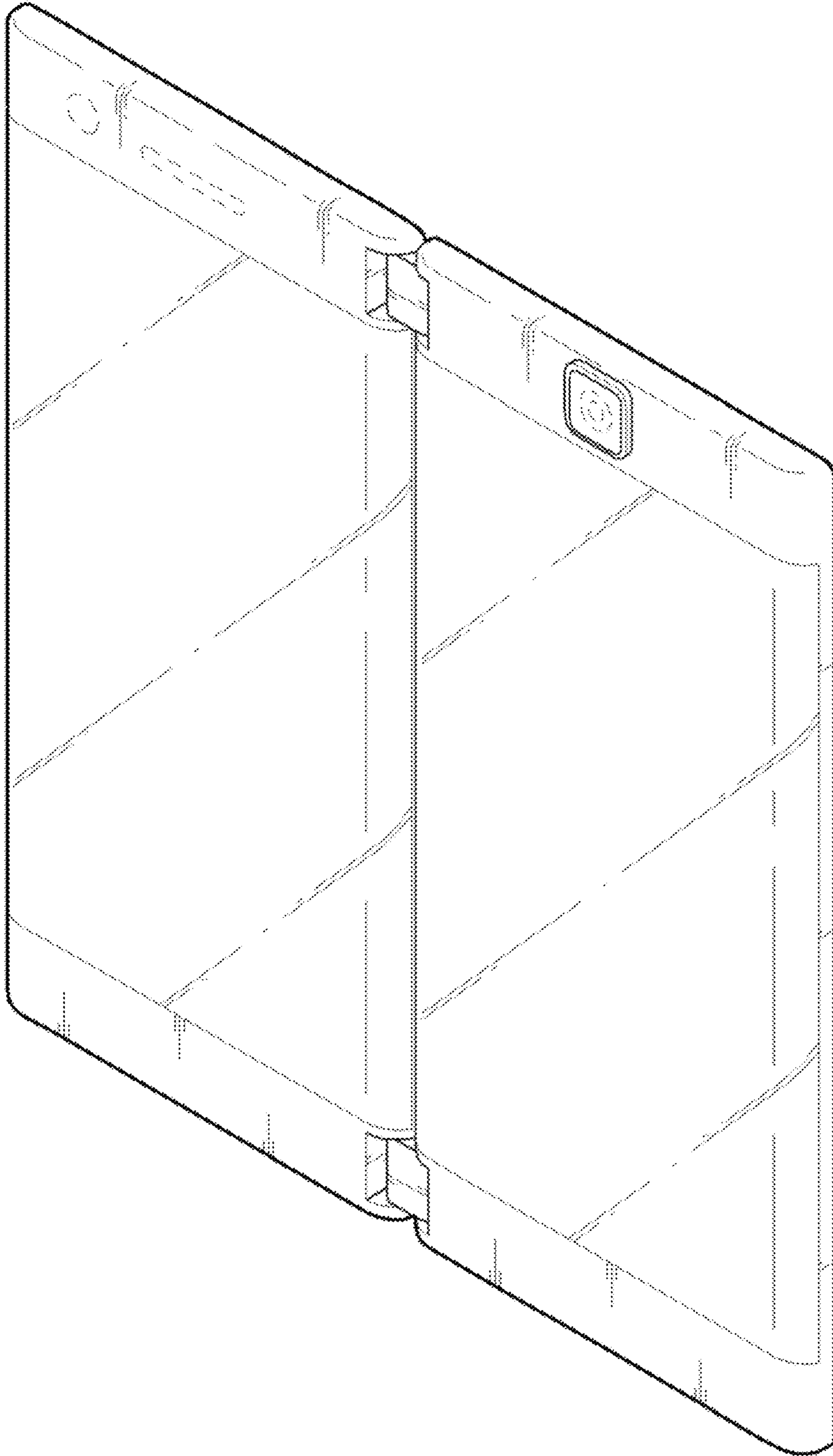

1.9

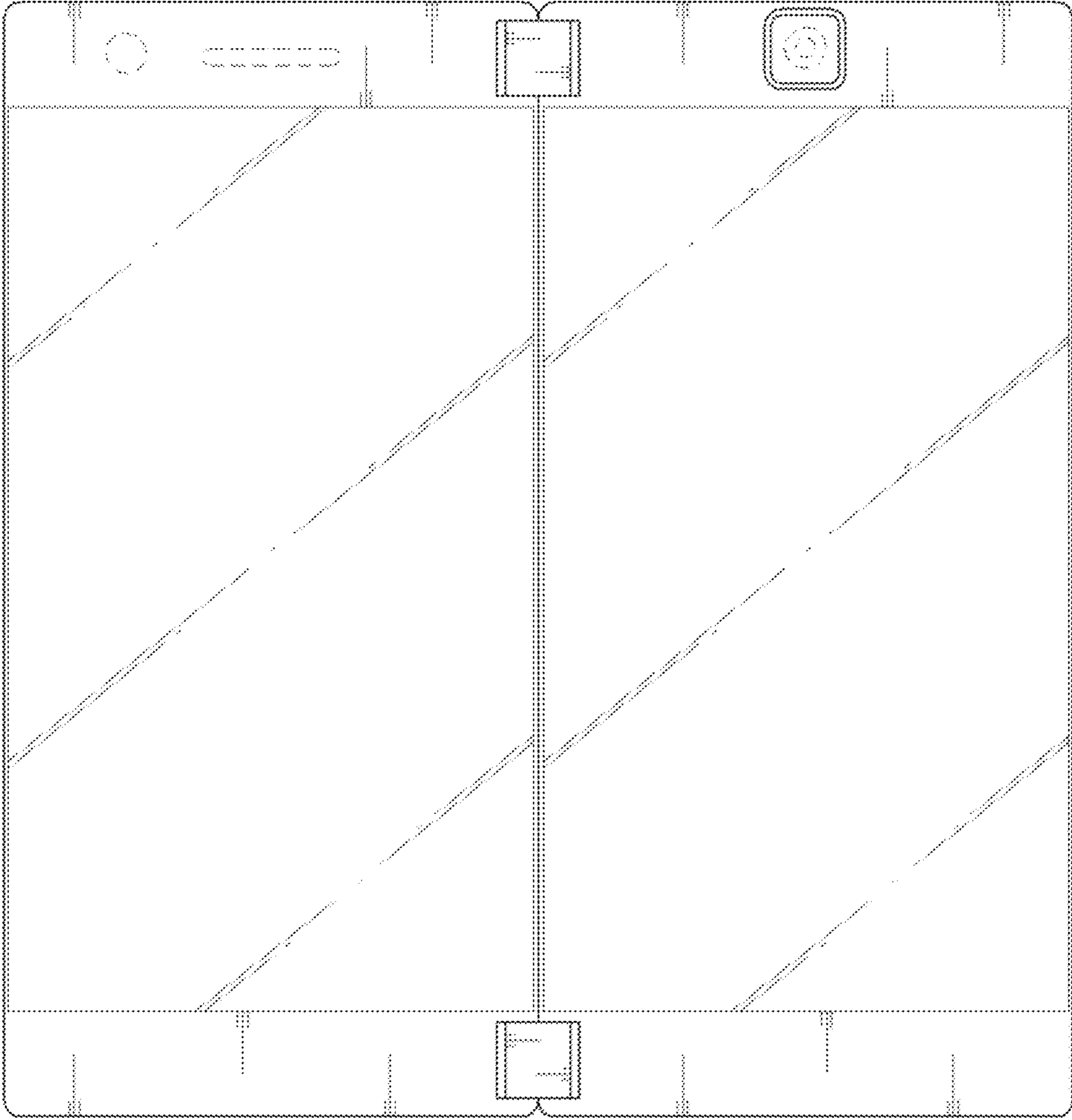

1.10

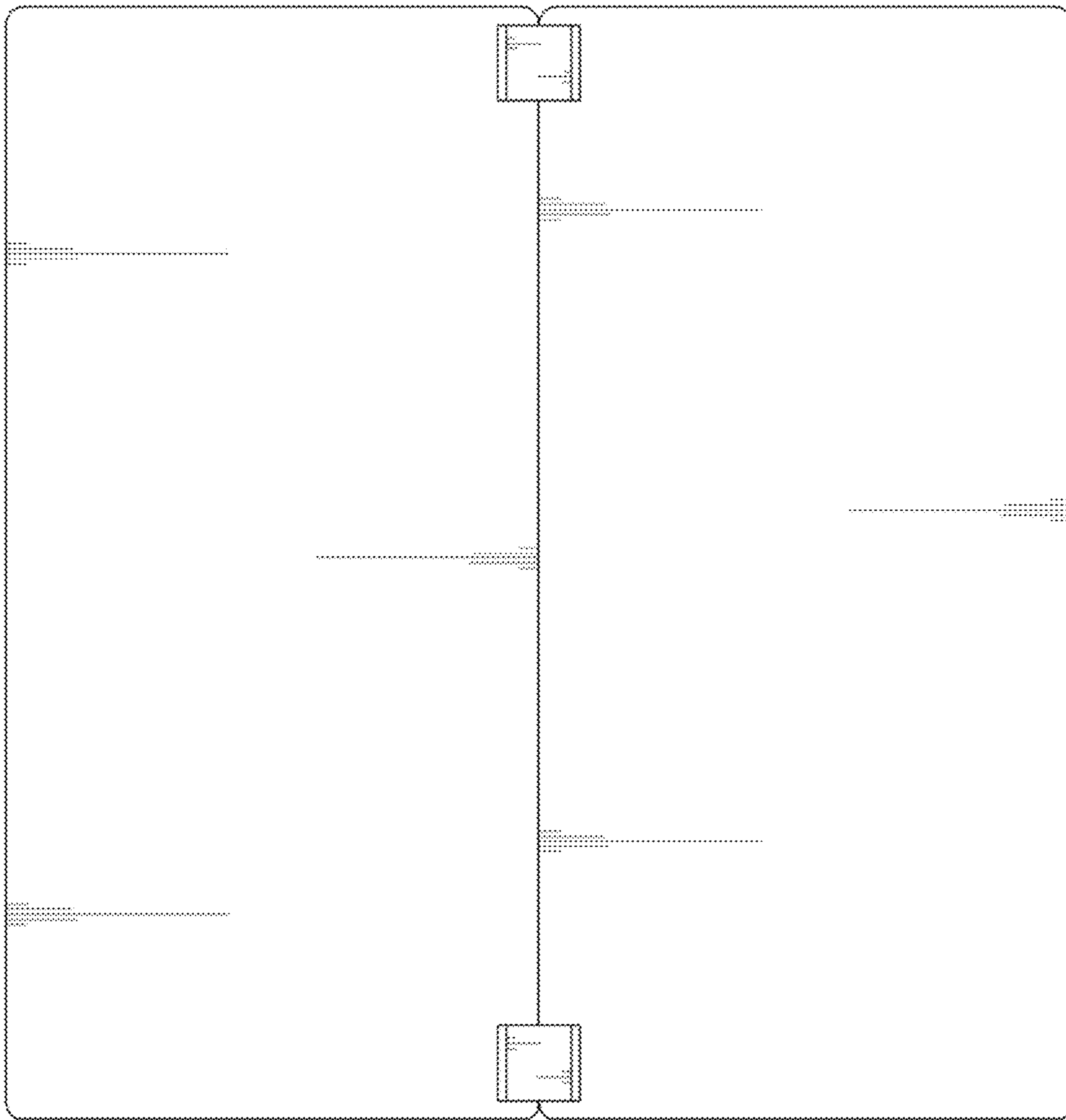

1.1

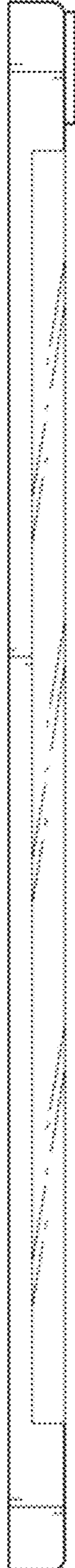

1.12



1.13

