



US00D829600S

(12) **United States Design Patent**
Thibadeau

(10) **Patent No.:** **US D829,600 S**
(45) **Date of Patent:** **** Oct. 2, 2018**

(54) **ZIPPER PULLER**

(71) Applicant: **Thule, Inc.**, Seymour, CT (US)

(72) Inventor: **Mark Thibadeau**, Boulder, CO (US)

(73) Assignee: **Thule, Inc.**, Seymour, CT (US)

(**) Term: **15 Years**

(21) Appl. No.: **29/611,658**

(22) Filed: **Jul. 24, 2017**

(51) **LOC (11) Cl.** **02-07**

(52) **U.S. Cl.**
USPC **D11/221**

(58) **Field of Classification Search**

USPC D11/200, 201, 221; 24/381–383,
24/385–389, 401, 414–417, 421–422,
24/427–431, 433, 434; 2/265; D2/641,
D2/642; 294/3.6; 223/118; D8/33, 34,
D8/40

CPC A44B 19/00; A44B 19/02; A44B 19/04;
A44B 19/10; A44B 19/26; A44B 19/30;
A44B 19/06; A44B 19/34; A44B 19/40;
A44B 19/52; A44B 19/38; G02C 3/003;
A44H 37/06; B29C 45/14573

See application file for complete search history.

(56) **References Cited**

U.S. PATENT DOCUMENTS

D123,188 S * 10/1940 Morin D11/221
D277,140 S * 1/1985 Abe D11/221

D575,191 S * 8/2008 Kojima D11/221
D579,378 S * 10/2008 Lobel D11/221
D621,297 S * 8/2010 Ohgaku D11/221
D645,783 S * 9/2011 Wang D11/221
D787,370 S * 5/2017 Hardy D11/221

* cited by examiner

Primary Examiner — Ralf Seifert

(74) *Attorney, Agent, or Firm* — Sterne, Kessler,
Goldstein & Fox P.L.L.C.

(57) **CLAIM**

The ornamental design for a zipper puller, as shown and described.

DESCRIPTION

FIG. 1 is a top front perspective view of a zipper puller showing the claimed design;
FIG. 2 is a front view thereof;
FIG. 3 is a rear view thereof;
FIG. 4 is a left side view thereof;
FIG. 5 is a right side view thereof;
FIG. 6 is a top view thereof;
FIG. 7 is a bottom view thereof;
FIG. 8 is a top front perspective view of a zipper puller showing a second embodiment of the claimed design;
FIG. 9 is a front view of FIG. 8;
FIG. 10 is a rear view of FIG. 8;
FIG. 11 is a left side view of FIG. 8;
FIG. 12 is a right side view of FIG. 8;
FIG. 13 is a top view of FIG. 8; and,
FIG. 14 is a bottom view of FIG. 8.

1 Claim, 14 Drawing Sheets

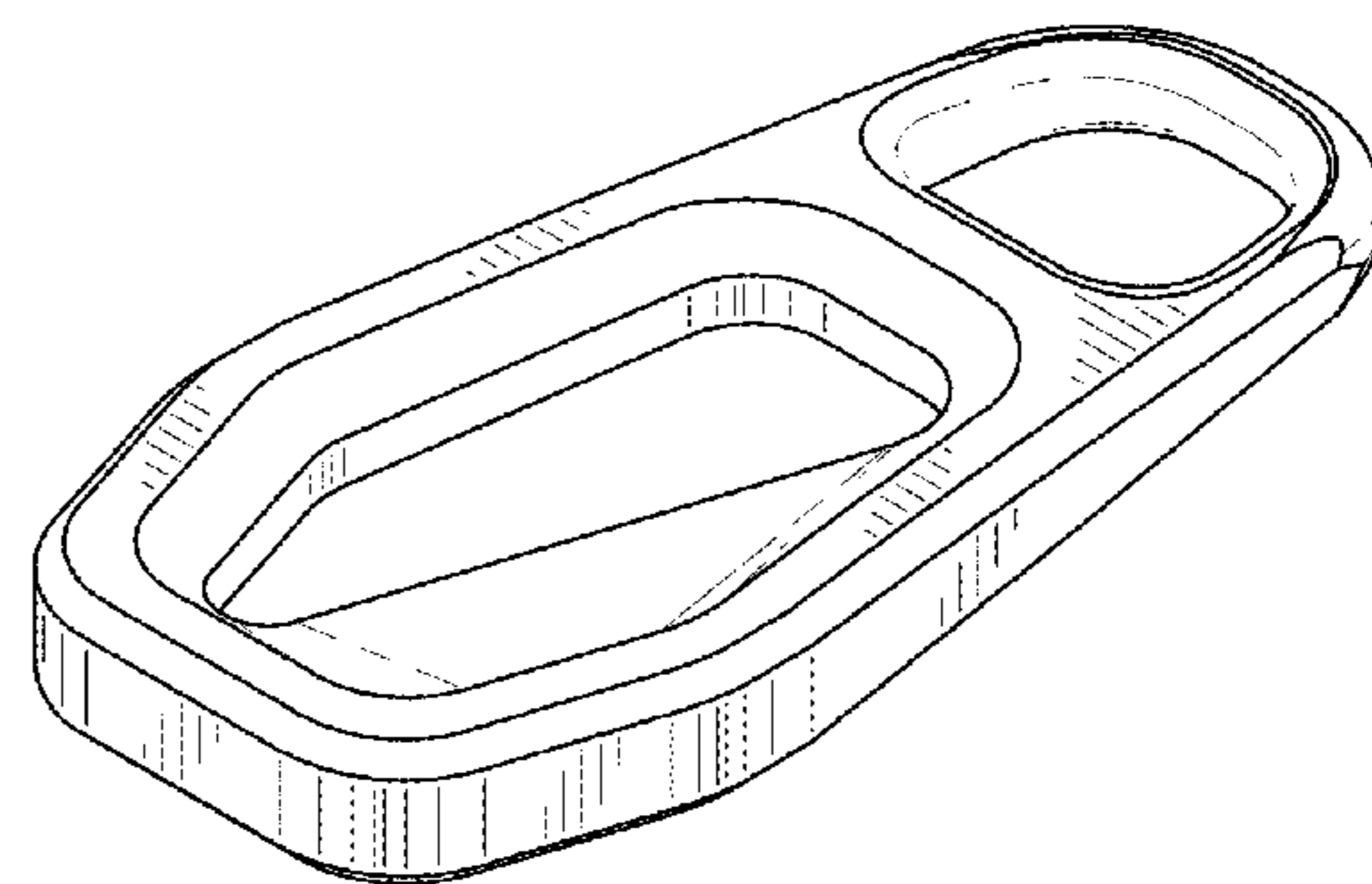
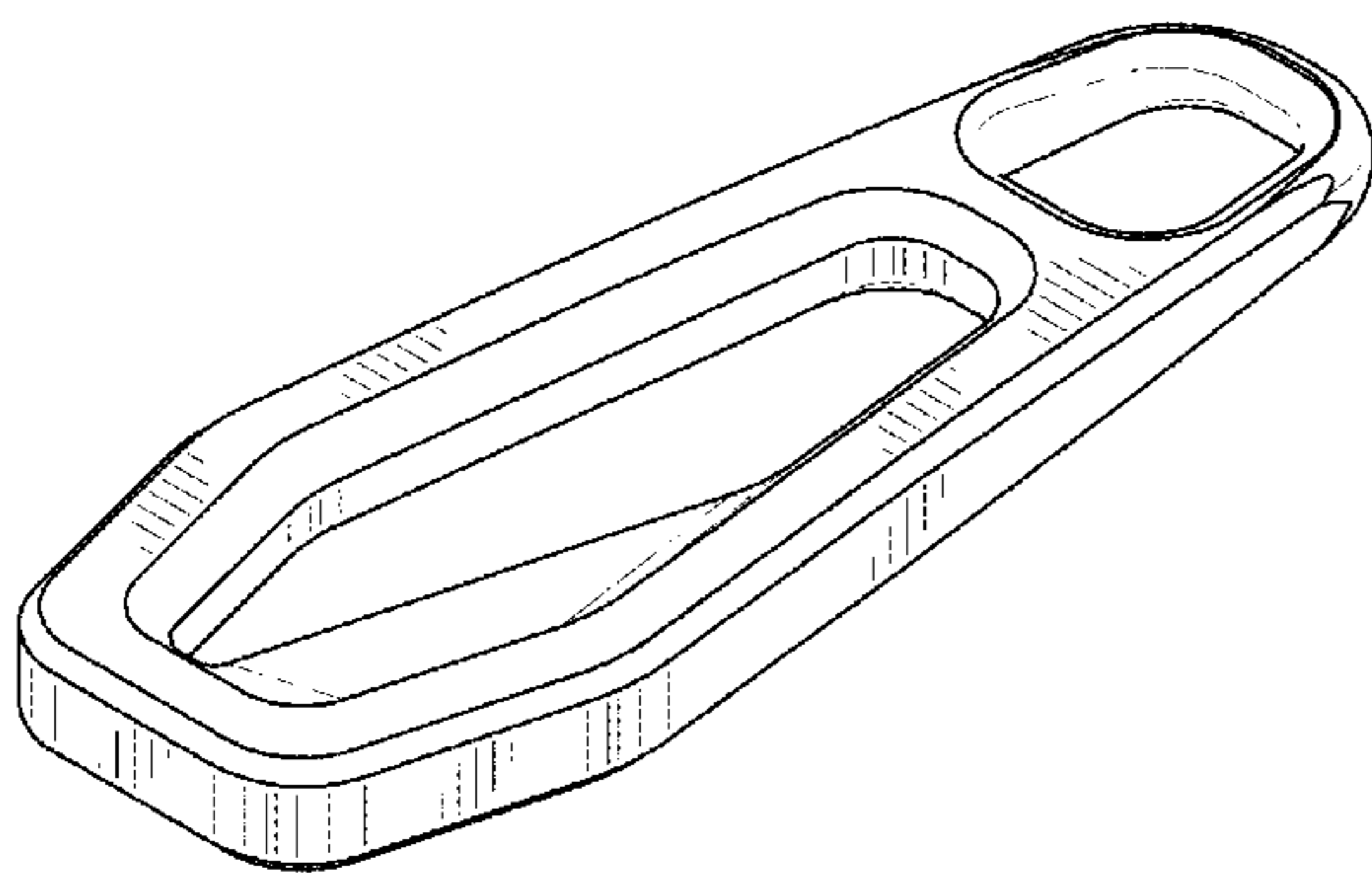

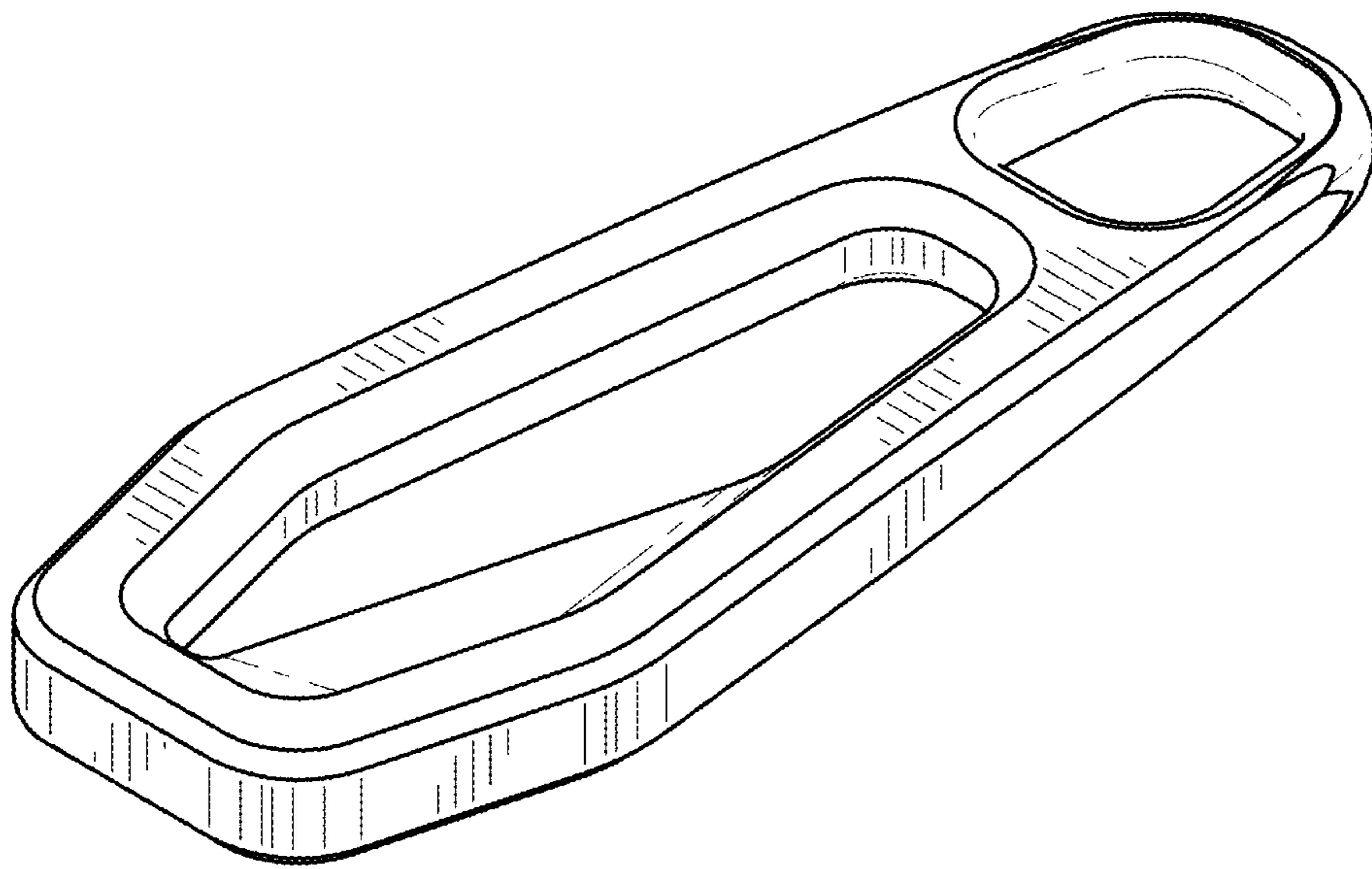

FIG.1

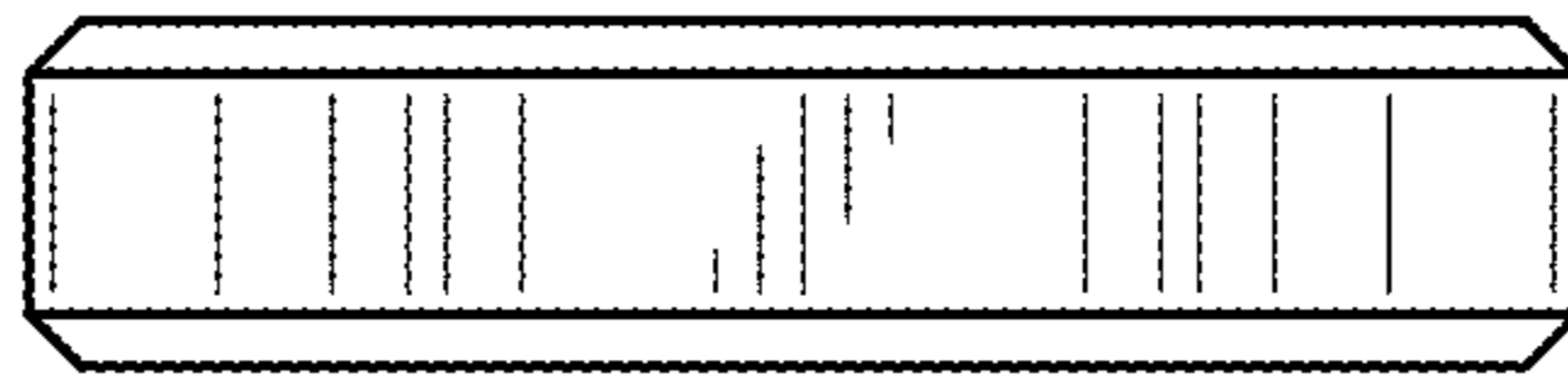

FIG. 2

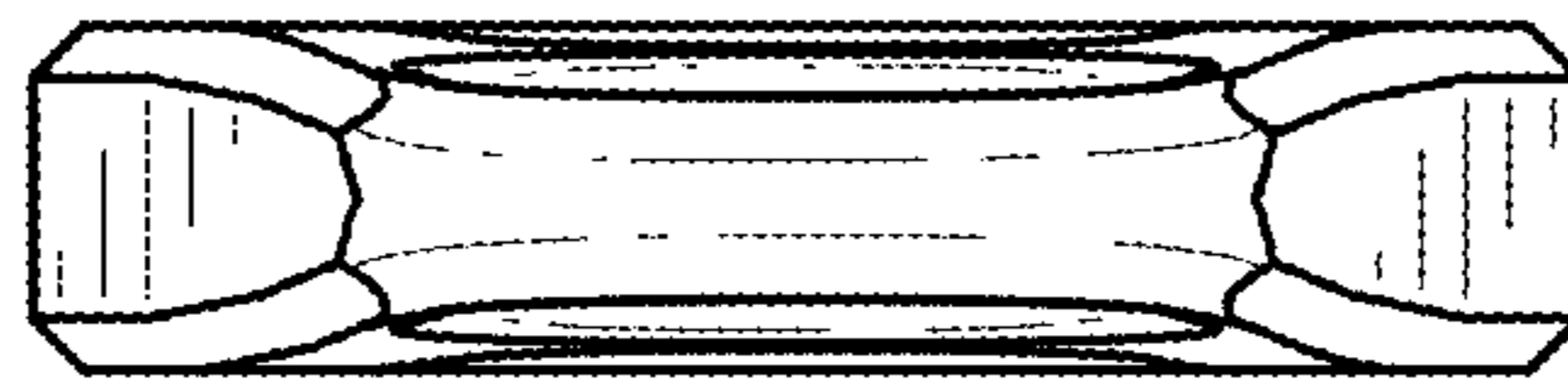

FIG.3

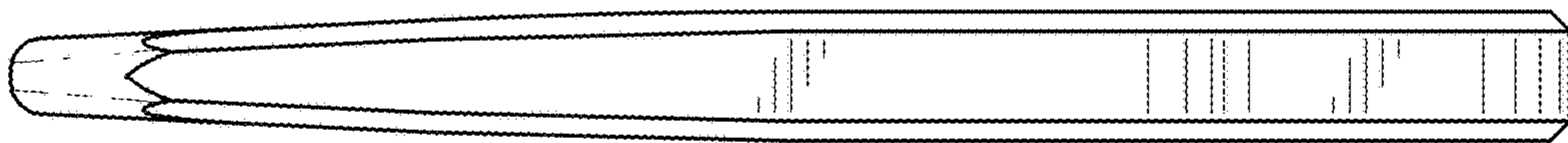

FIG. 4



FIG. 5

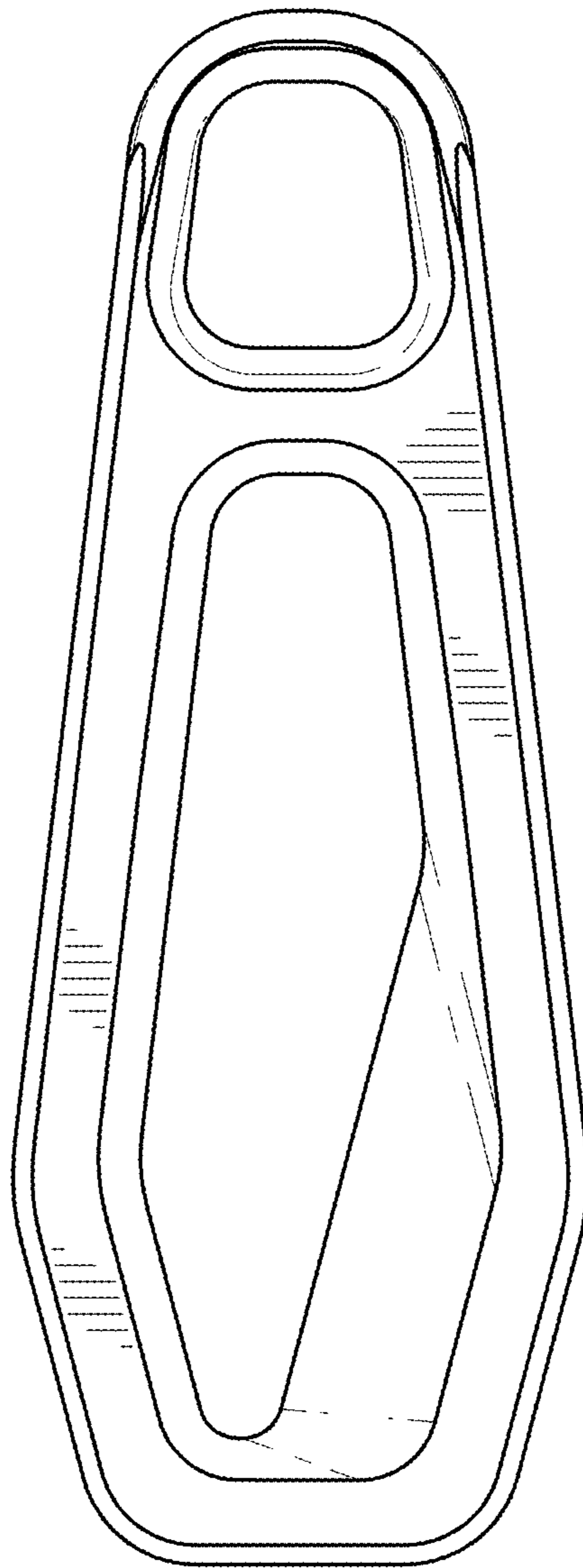

FIG.6

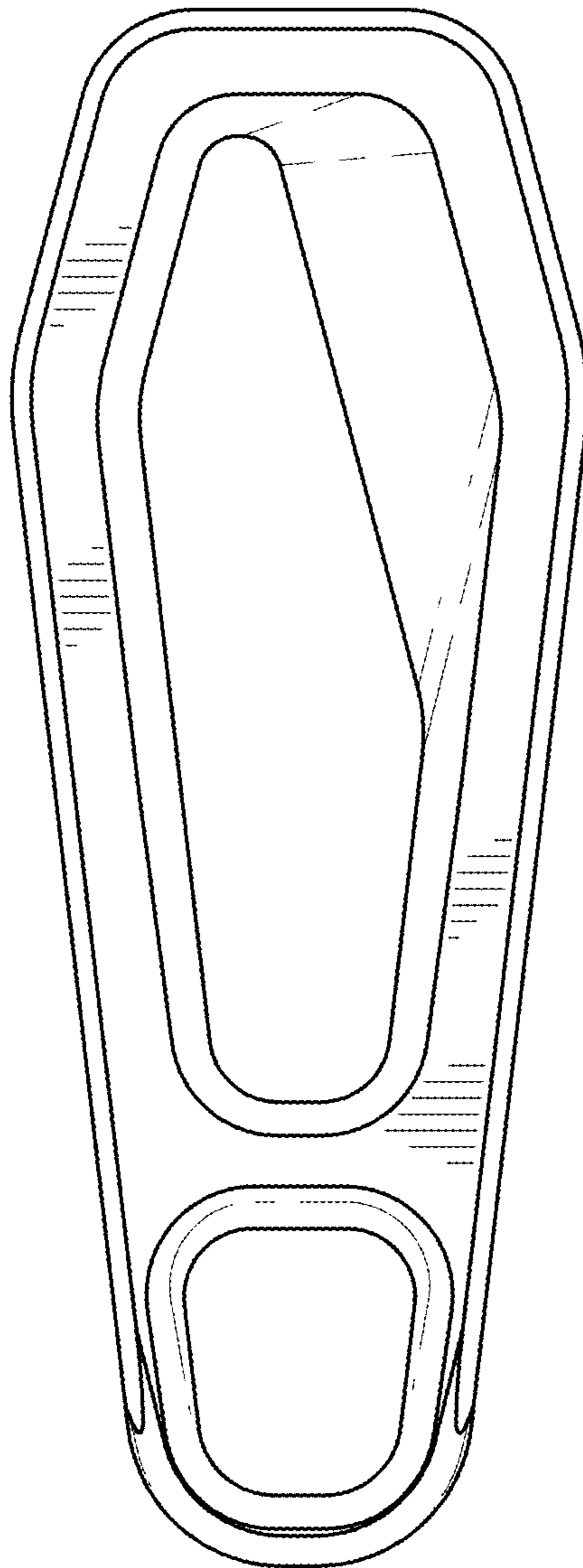

FIG.7

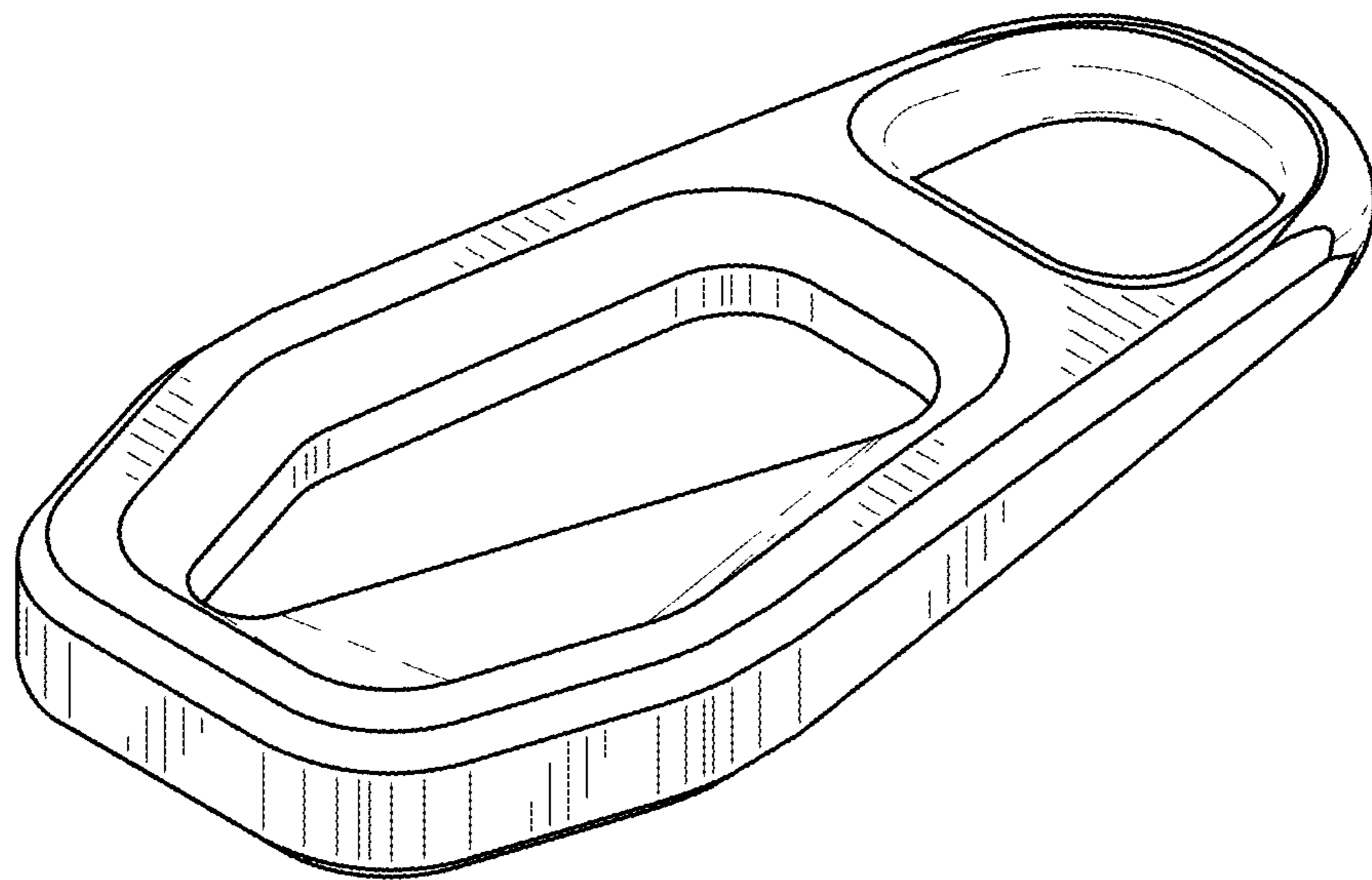

FIG.8

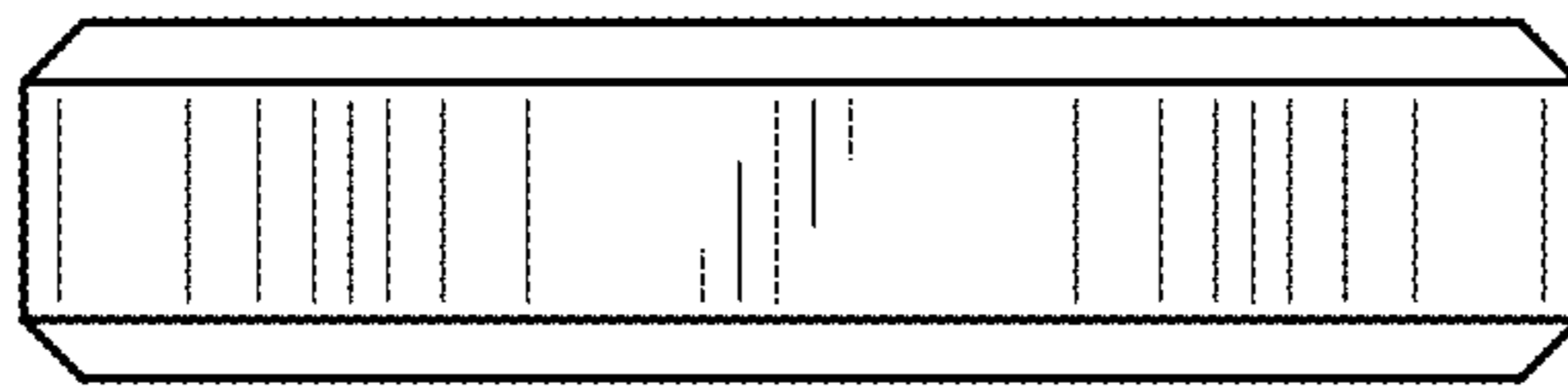

FIG.9

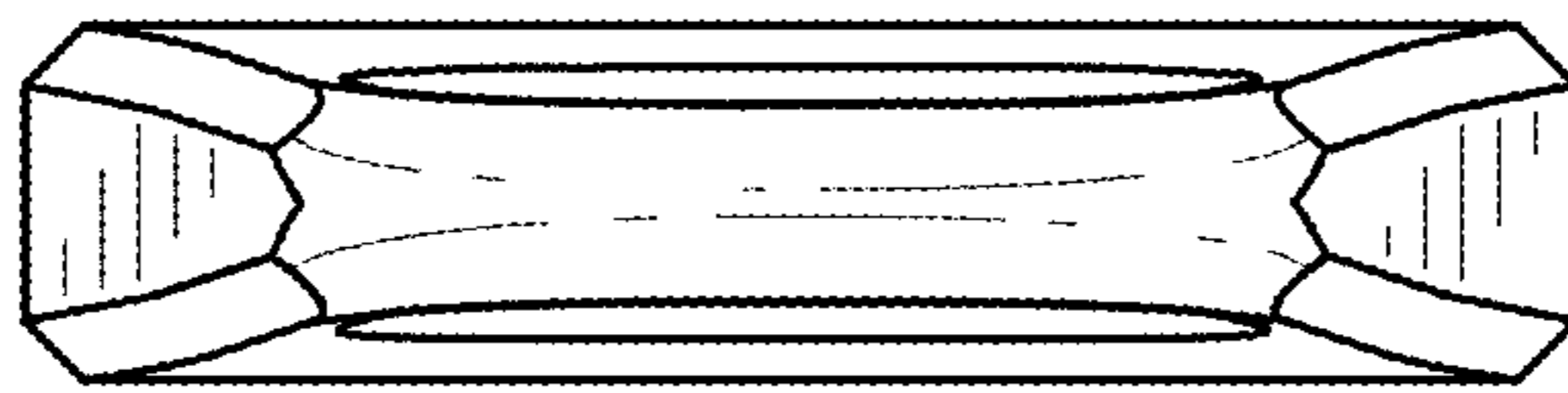

FIG.10

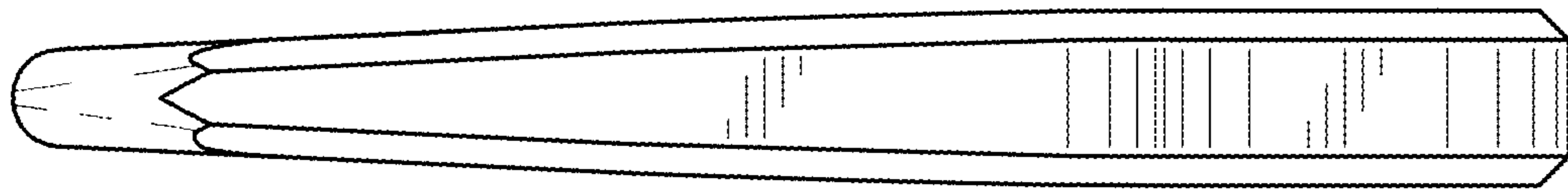

FIG.11

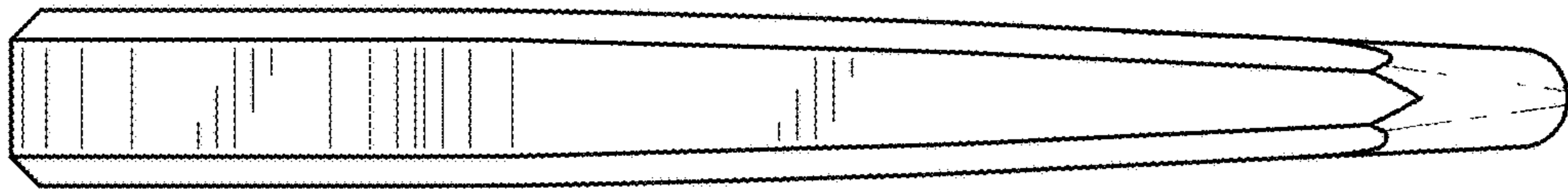

FIG.12

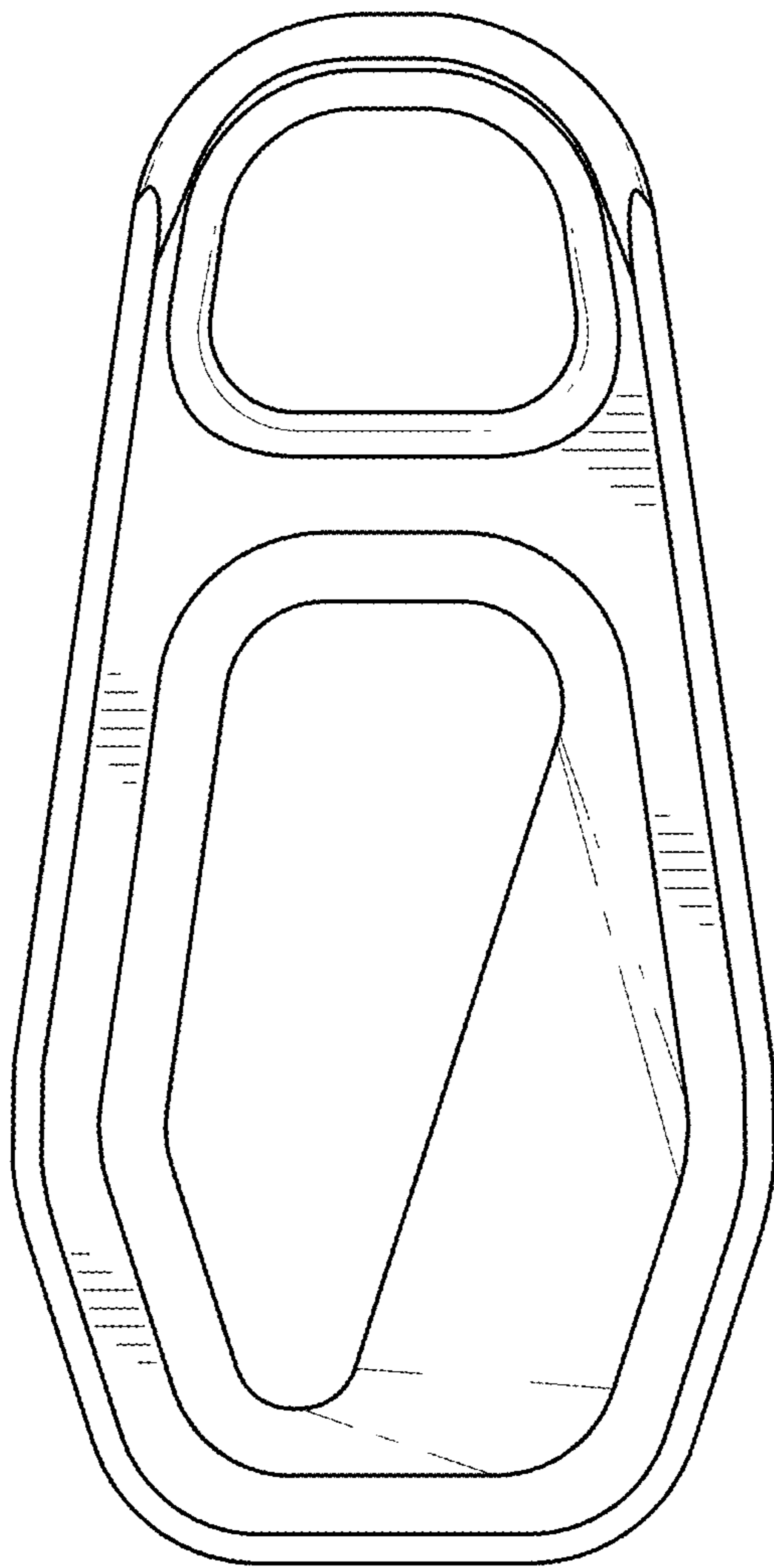

FIG.13

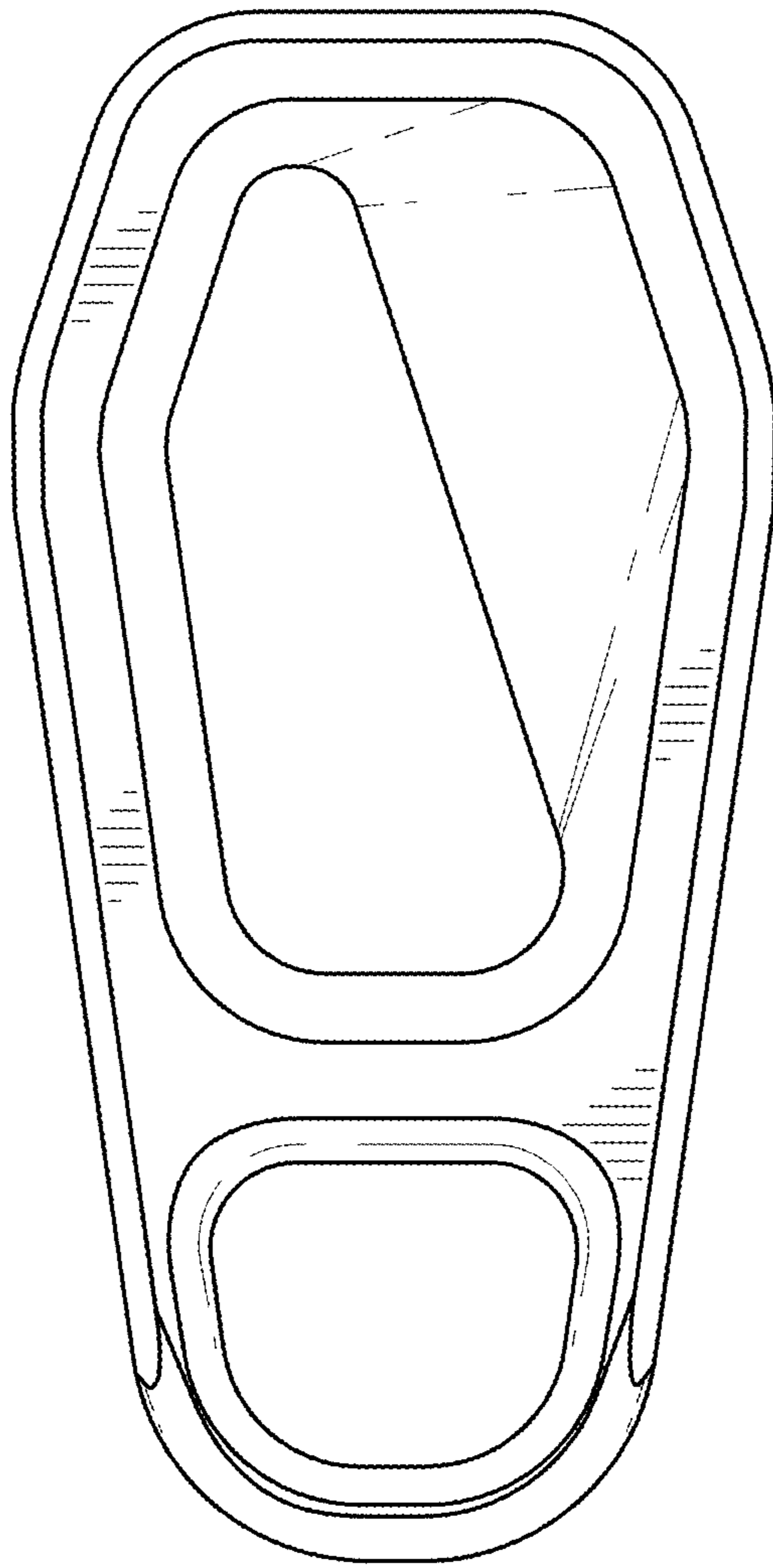

FIG. 14