



US00D829573S

(12) **United States Design Patent** (10) **Patent No.:** **US D829,573 S**  
**Okazaki et al.** (45) **Date of Patent:** **\*\* Oct. 2, 2018**

(54) **CASE FOR MEASUREMENT CONTROL DEVICE**

D307,708 S \* 5/1990 Moriyama et al. .... D13/164  
D579,796 S \* 11/2008 Schmid ..... D10/49  
D677,587 S \* 3/2013 Mueller ..... D10/49

(71) Applicant: **MEIDENSHA CORPORATION**,  
Tokyo (JP)

(Continued)

(72) Inventors: **Nobuo Okazaki**, Hachioji (JP);  
**Akihiko Kodama**, Ota (JP)

*Primary Examiner* — Antoine D Davis

(74) *Attorney, Agent, or Firm* — Foley & Lardner LLP

(73) Assignee: **MEIDENSHA CORPORATION**,  
Tokyo (JP)

(57) **CLAIM**

We claim the ornamental design for a case for measurement control device, as shown and described.

(\*\*) Term: **15 Years**

**DESCRIPTION**

(21) Appl. No.: **29/585,284**

(22) Filed: **Nov. 22, 2016**

(30) **Foreign Application Priority Data**

May 24, 2016 (JP) ..... 2016-011073

(51) **LOC (11) Cl.** ..... **10-04**

(52) **U.S. Cl.**  
USPC ..... **D10/49; D13/163**

(58) **Field of Classification Search**  
USPC ..... D10/49; D13/162, 162.1, 163, 164  
CPC ... G01L 5/06; G01L 5/101; G01L 3/18; G01L 3/20; G01L 3/22; G01L 3/1478; G01L 3/1471; G01L 3/16; G01L 3/08; G01L 1/04; G01L 1/14; G01L 1/20; G01L 1/2212; G01L 1/2237; G01R 31/34; Y10S 60/912; H02K 49/08; H02K 49/046; G01G 3/1404; G01G 19/18; G01M 15/044; G01M 15/02; G01M 15/09; G01M 17/0072; G01B 7/24

See application file for complete search history.

(56) **References Cited**

**U.S. PATENT DOCUMENTS**

D271,569 S \* 11/1983 Lui ..... D10/49  
D290,818 S \* 7/1987 Tomozawa ..... D10/40

FIG. 1 is a front view of an embodiment of a case for measurement control device according to the claimed design;

FIG. 2 is a rear view of the embodiment shown in FIG. 1; FIG. 3 is a plan view of the embodiment shown in FIG. 1, in a closed condition;

FIG. 4 is a bottom view of the embodiment shown in FIG. 1, in a closed condition;

FIG. 5 is a right side view of the embodiment shown in FIG. 1, in a closed condition;

FIG. 6 is a left side view of the embodiment shown in FIG. 1, in a closed condition;

FIG. 7 is a right side perspective view of the embodiment shown in FIG. 1, in a closed condition;

FIG. 8 is a left side perspective view of the embodiment shown in FIG. 1, in a closed condition;

FIG. 9 is a plan view of the embodiment shown in FIG. 1, in an open condition;

FIG. 10 is a right side view of the embodiment shown in FIG. 1, in an open condition; and,

FIG. 11 is a right side perspective view of the embodiment shown in FIG. 1, in an open condition.

The ornamental design which is claimed is shown in solid lines in the drawings. The broken lines in the drawings are for illustrative purposes only and form no part of the claimed design.

**1 Claim, 11 Drawing Sheets**

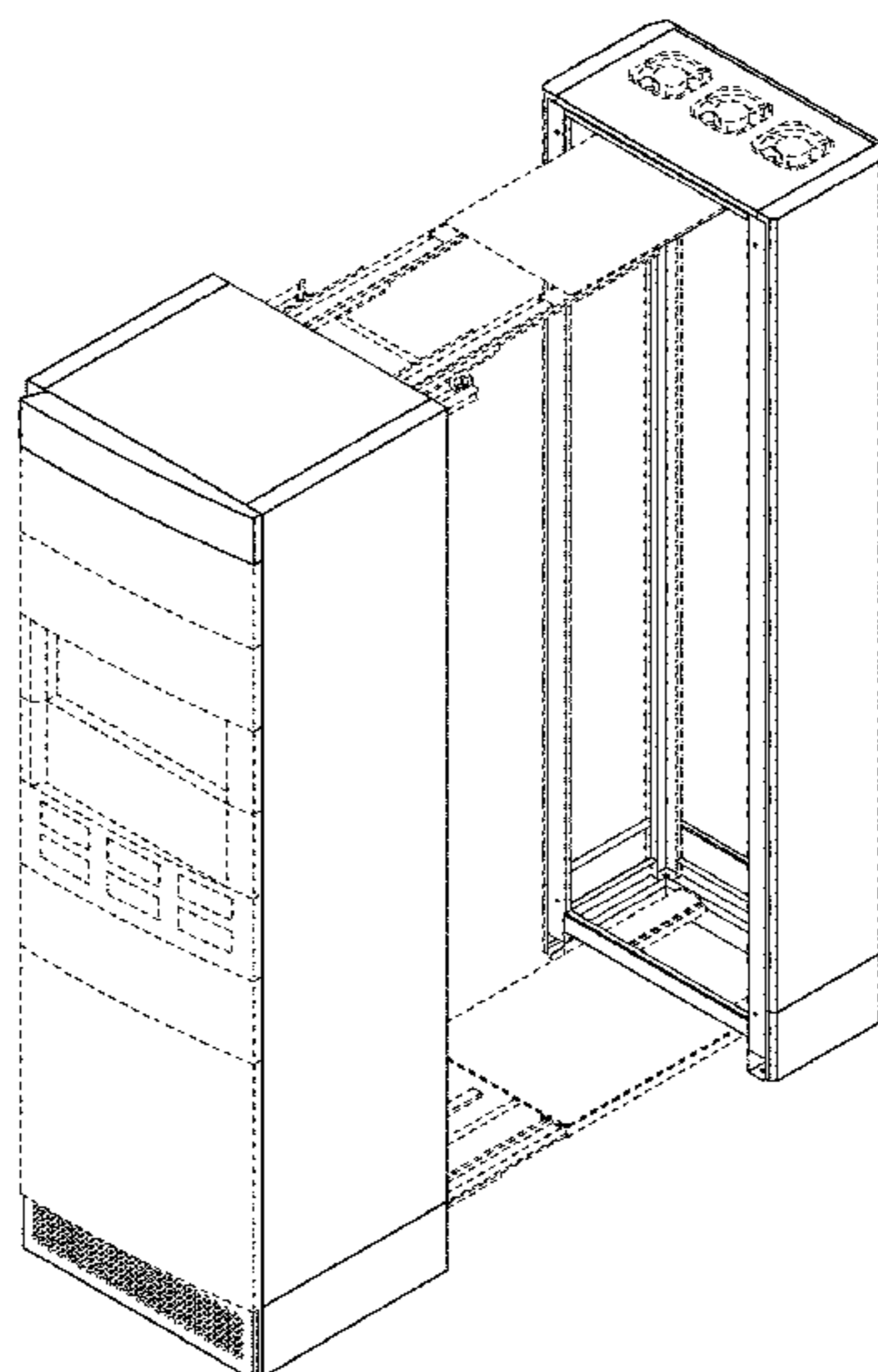

(56)

**References Cited**

U.S. PATENT DOCUMENTS

D704,078 S \* 5/2014 Mueller et al. .... D10/64  
D811,332 S \* 2/2018 Siddiqui et al. .... D13/162

\* cited by examiner

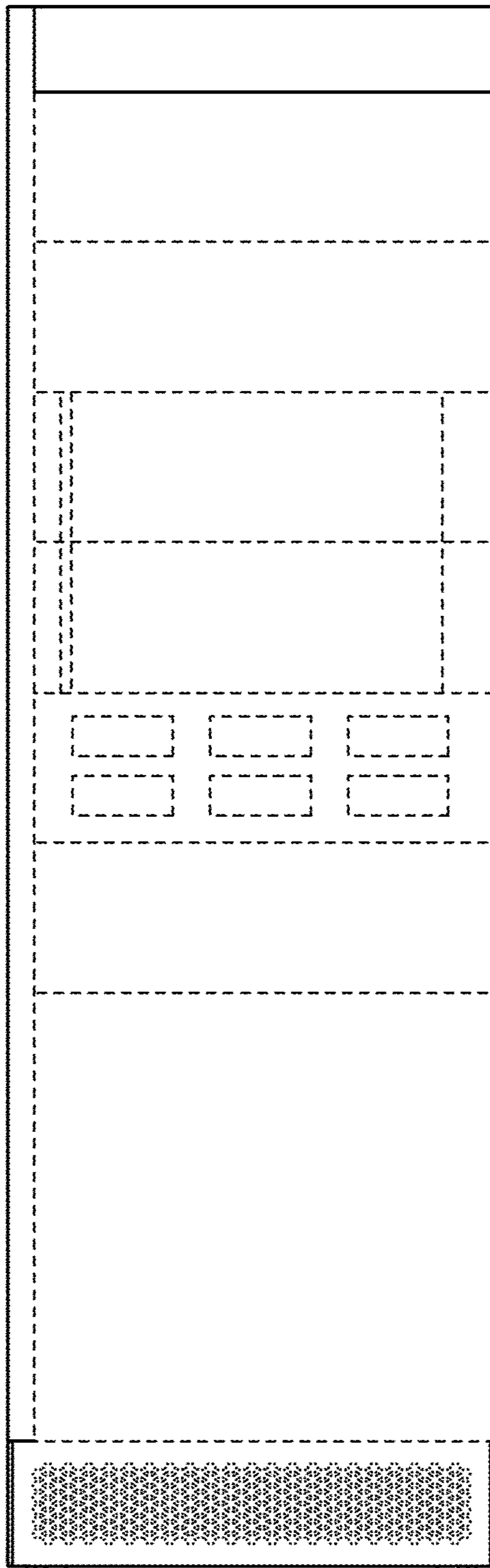

**Fig. 1**

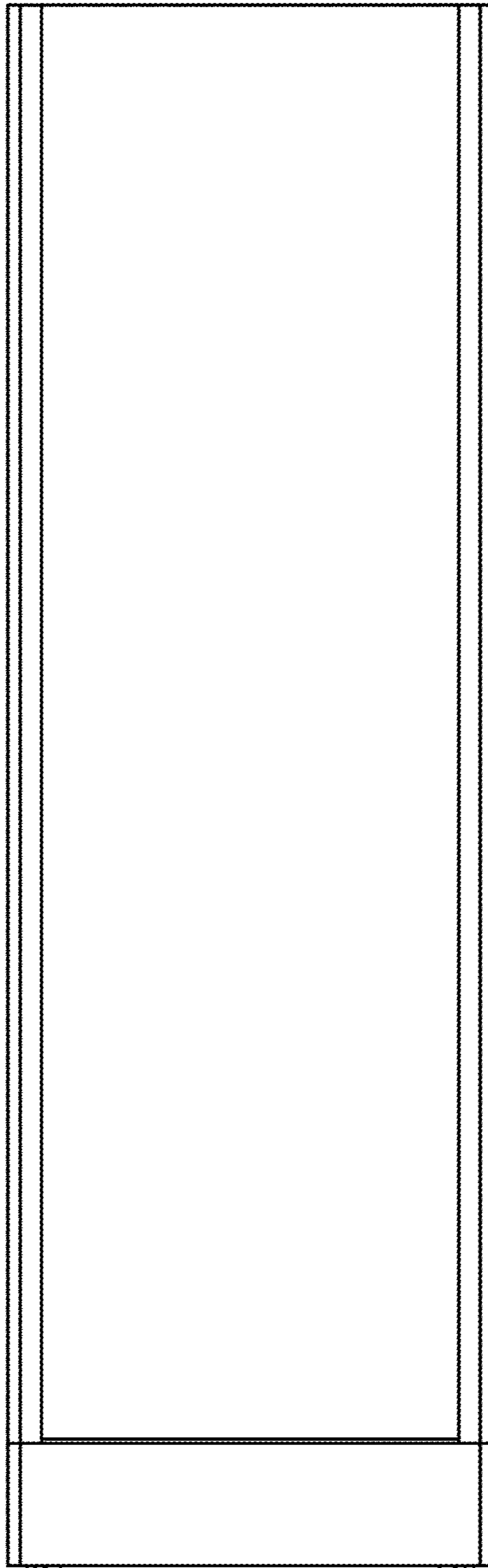

**Fig. 2**

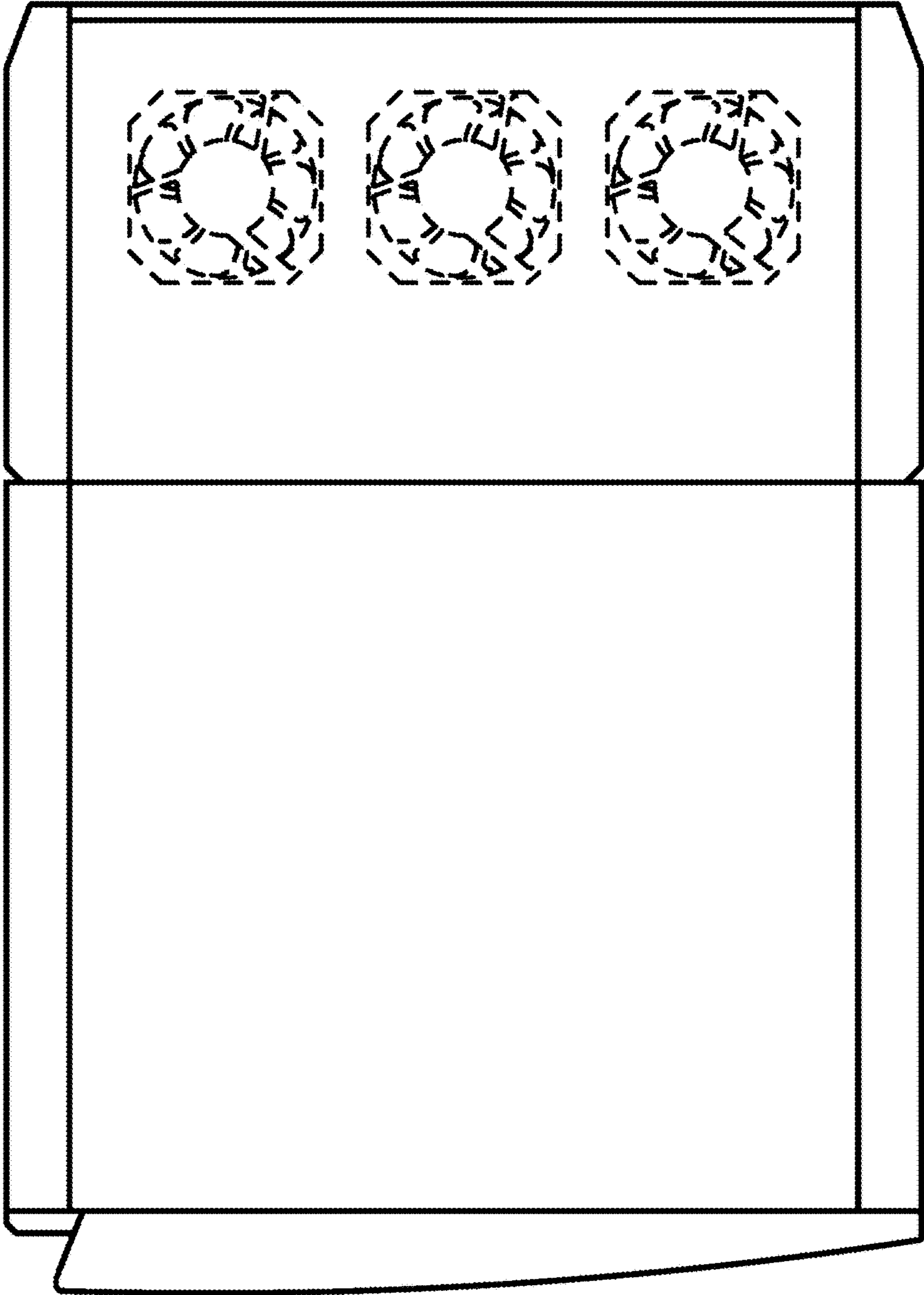

Fig. 3

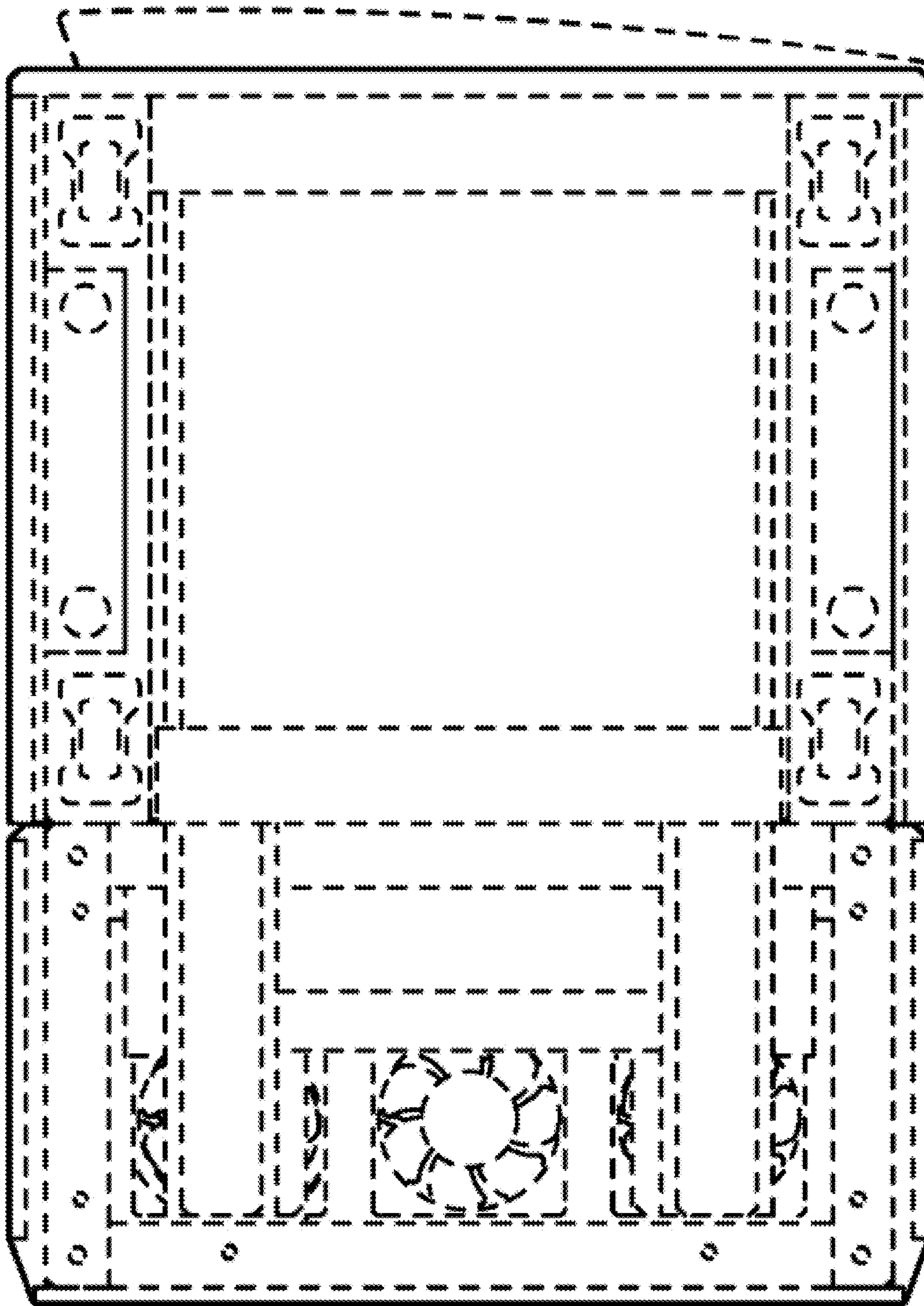

Fig. 4

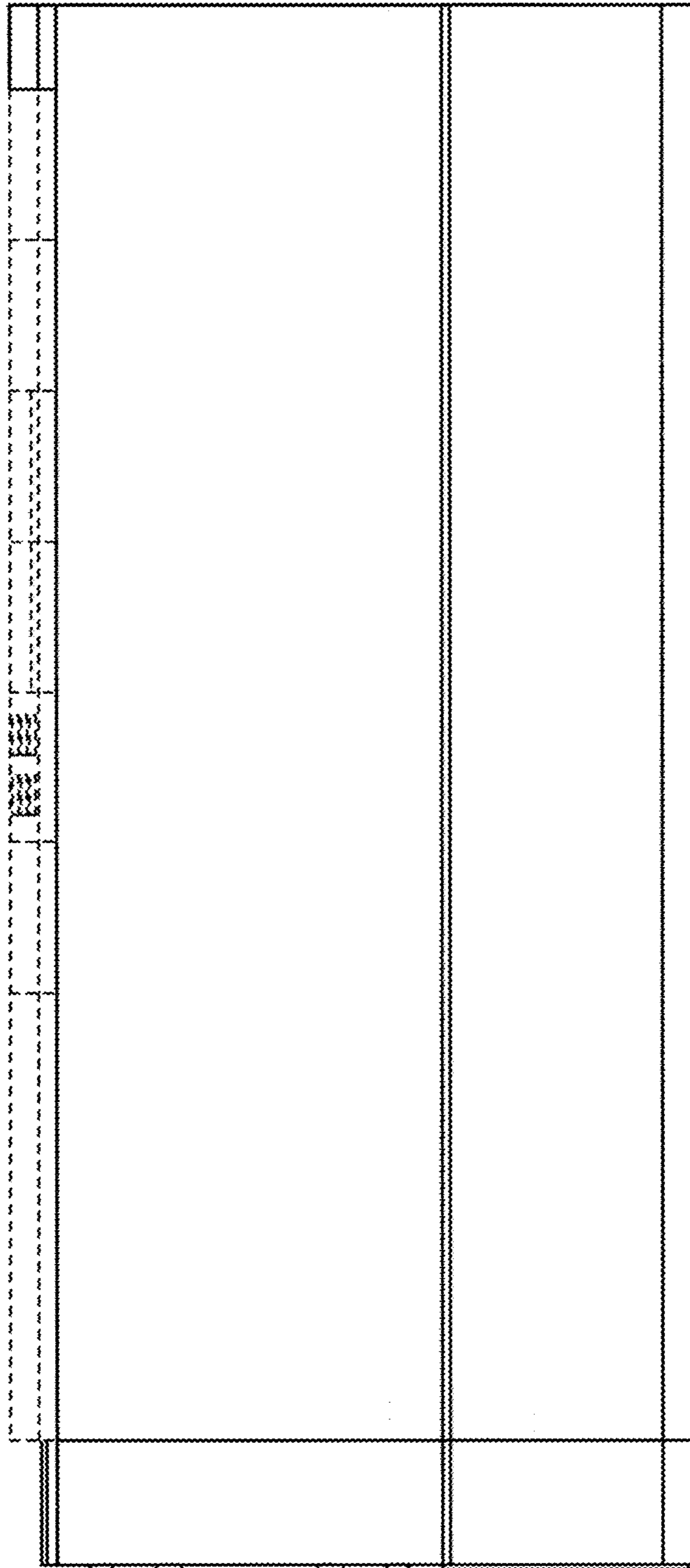

Fig. 5

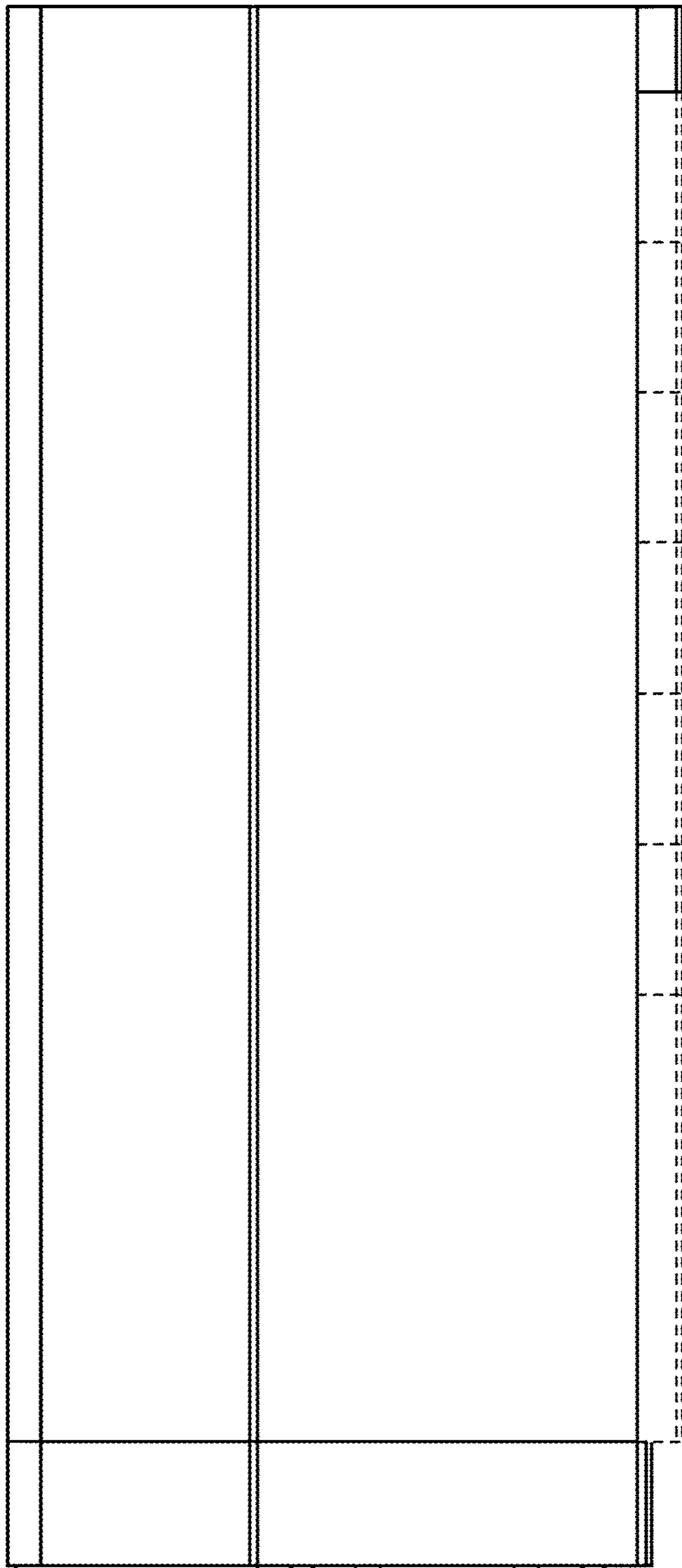
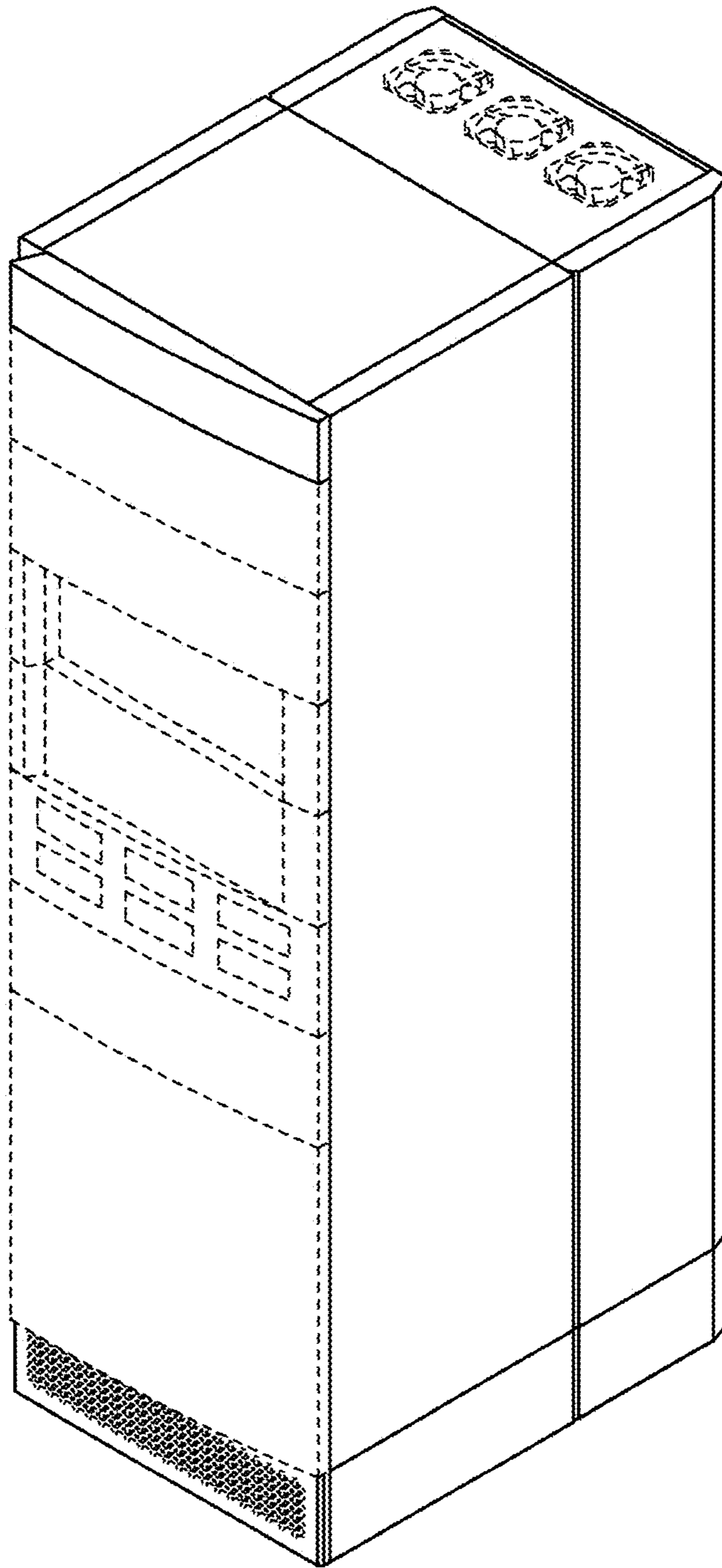
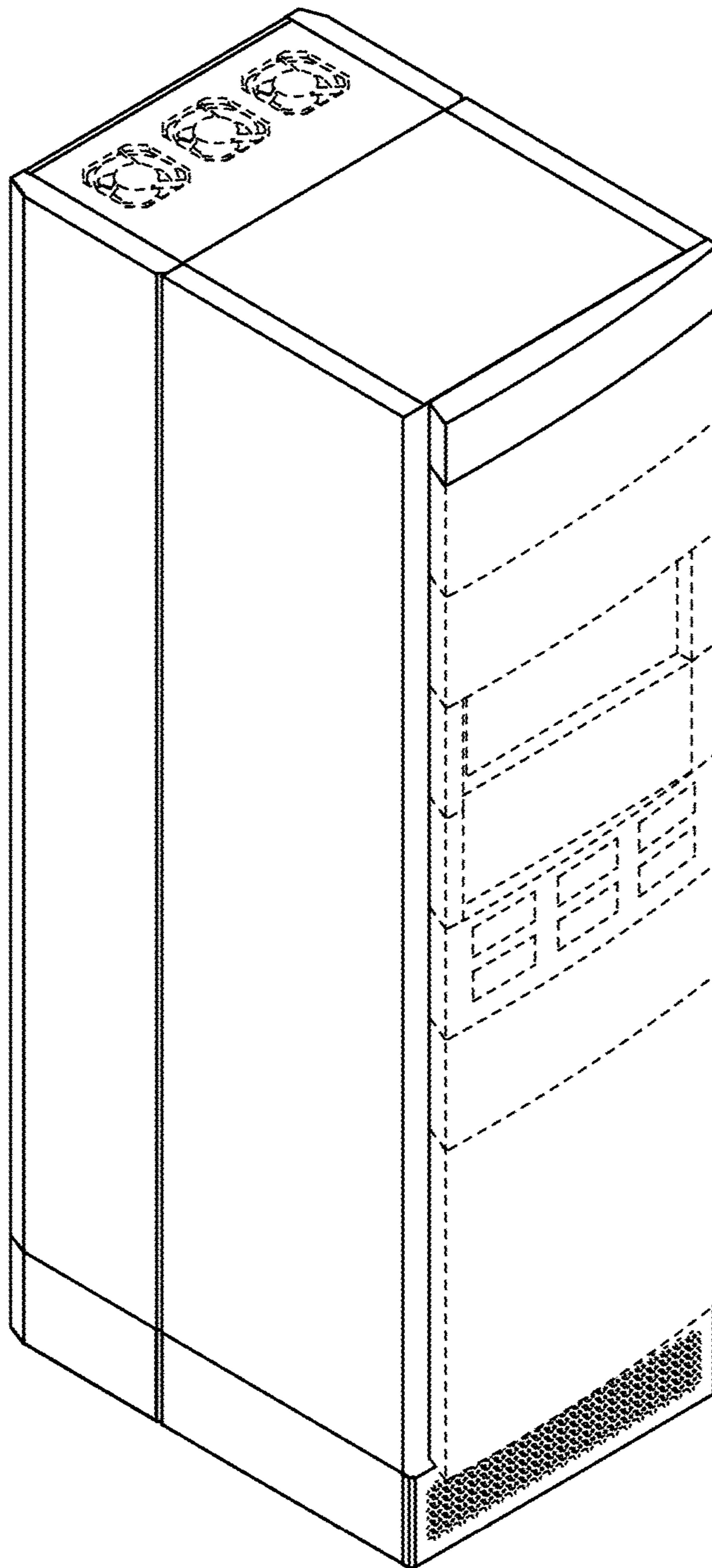

Fig. 6

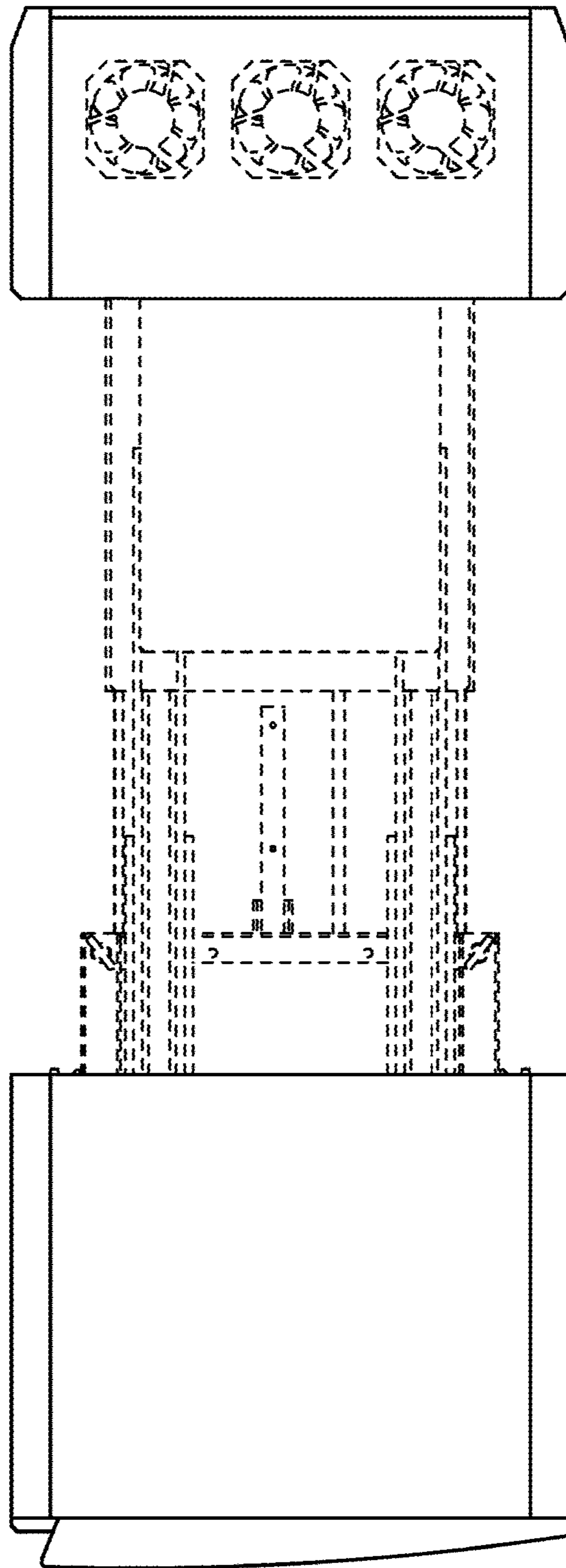



**Fig. 7**



**Fig. 8**



**Fig. 9**

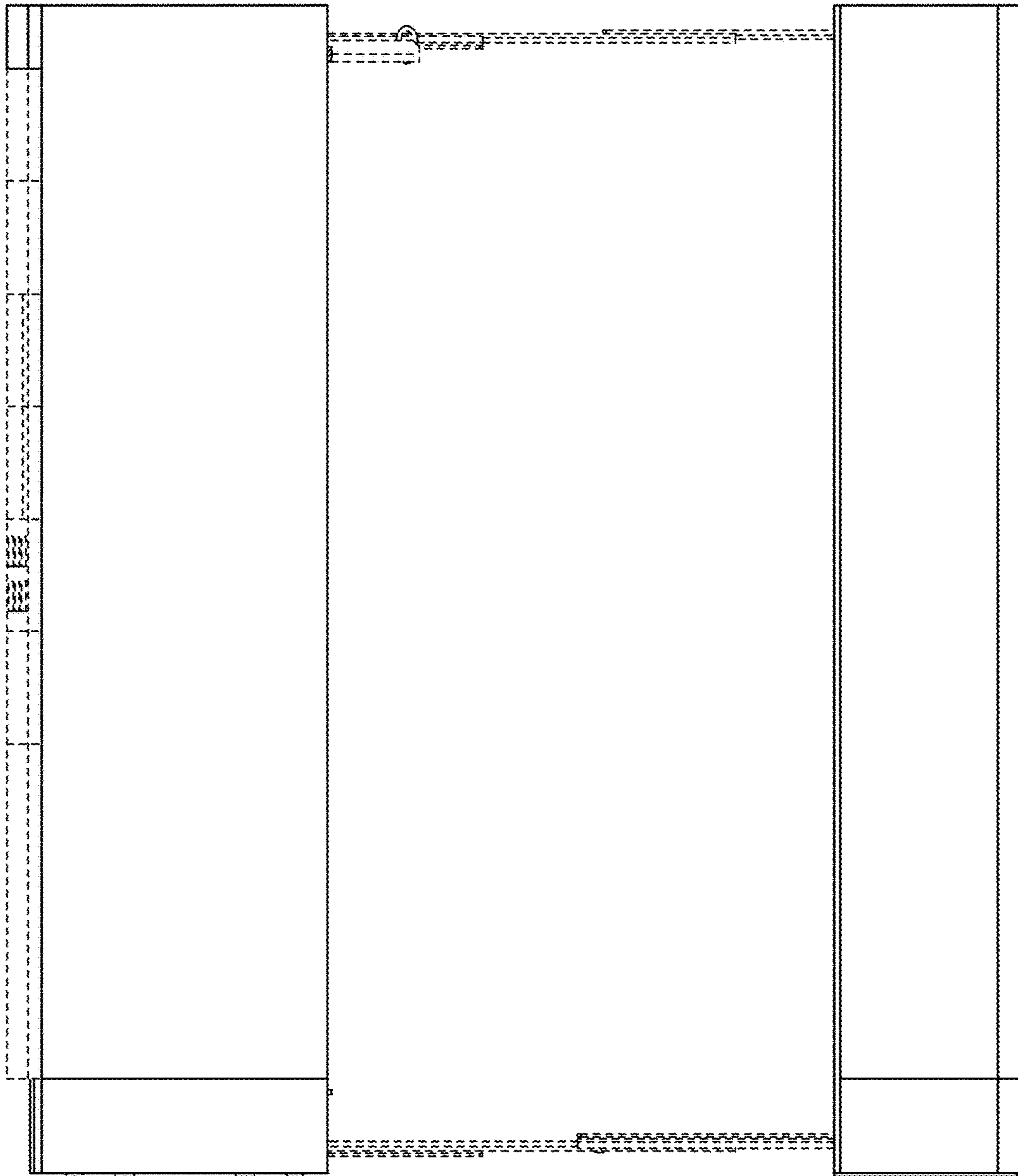

Fig. 10

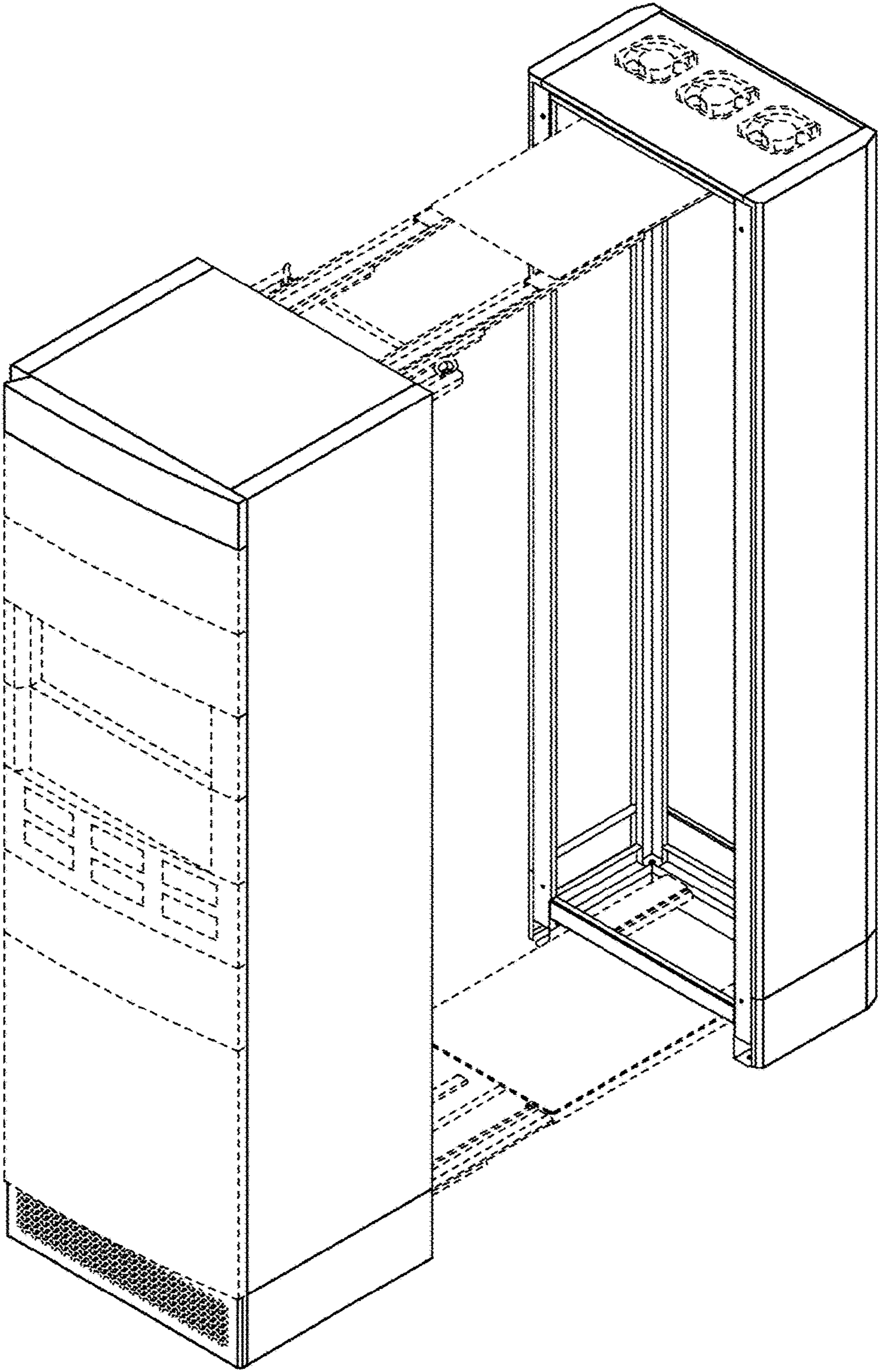

Fig. 11