



US00D829569S

(12) **United States Design Patent**
O'Neill

(10) **Patent No.:** **US D829,569 S**
(45) **Date of Patent:** **** Oct. 2, 2018**

(54) **PACKAGING**

(71) Applicant: **SUGARFINA, INC.**, Inglewood, CA
(US)

(72) Inventor: **Rosie Colleen O'Neill**, Inglewood, CA
(US)

(73) Assignee: **SUGARFINA, INC.**, El Segundo, CA
(US)

(**) Term: **15 Years**

(21) Appl. No.: **29/618,030**

(22) Filed: **Sep. 18, 2017**

(51) **LOC (11) Cl.** **09-03**

(52) **U.S. Cl.**

USPC **D9/759**; D9/420; D9/721

(58) **Field of Classification Search**

USPC D9/414-419, 420-423, 430-434, 715,
D9/721, 737, 756, 759, 760; D7/601,
D7/602, 610, 701

CPC B65D 5/00; B65D 5/0015; B65D 5/061;
B65D 5/18; B65D 5/20; B65D 5/32;
B65D 5/321; B65D 5/322

See application file for complete search history.

(56) **References Cited**

U.S. PATENT DOCUMENTS

228,158 A	5/1880	Woods
D36,435 S	7/1903	Daggett
1,162,840 A	12/1915	Wood
1,588,857 A	6/1926	Sherman
D71,513 S	11/1926	Austin
1,620,789 A	3/1927	Urban, Jr.
1,697,880 A	1/1929	Peter
1,762,923 A	6/1930	Fegely
D86,128 S	2/1932	Levkoff
1,871,617 A	8/1932	King
1,892,092 A	12/1932	Barad
1,899,547 A	2/1933	Addis et al.
1,994,159 A	3/1935	Wurzburg
D95,429 S	4/1935	James et al.
2,511,211 A	6/1950	Klein et al.

2,522,049 A	9/1950	Lang
2,541,173 A	2/1951	Moore
2,597,377 A	5/1952	Robinson
2,604,980 A	7/1952	Reid
2,751,135 A	6/1956	Kessler
2,782,951 A	2/1957	Inman
2,790,589 A	4/1957	Moore
3,004,661 A	10/1961	Schumann
3,126,093 A	3/1964	Bradley et al.
3,357,543 A	12/1967	Taggart
3,423,006 A	1/1969	Stedman
3,494,534 A	2/1970	McFarland et al.
3,600,871 A	8/1971	Farquhar
3,660,934 A	5/1972	Pollack et al.
D242,771 S	12/1976	Papillon
D244,085 S	4/1977	Giddings et al.
4,139,096 A	2/1979	Sieger
D258,938 S	4/1981	Spitzer
4,293,079 A	10/1981	Lytle
D292,876 S	11/1987	Grunhut
D292,877 S	11/1987	Grunhut
4,713,928 A	12/1987	Tisma
4,757,898 A	7/1988	Klein
D307,504 S	4/1990	Silcox
D315,297 S	3/1991	Campbell
D317,717 S	6/1991	Carol
D317,718 S	6/1991	Carol
5,038,940 A	8/1991	Okabe
5,096,056 A	3/1992	Garcia
5,104,124 A	4/1992	Bernard
D327,004 S *	6/1992	Nadel D9/432
D329,601 S	9/1992	Samelson
D333,615 S	3/1993	Zutler
D335,819 S	5/1993	Campbell
D344,020 S	2/1994	Pavely
5,375,706 A	12/1994	Perez
D361,508 S	8/1995	Schnack
D361,661 S	8/1995	Masuda
D373,723 S *	9/1996	Healey D9/433
5,555,982 A	9/1996	Kuhn et al.
5,590,786 A	1/1997	Jaycox
5,603,558 A	2/1997	Zimmer
D380,417 S	7/1997	Hardy
D380,926 S	7/1997	Goodburn et al.
5,682,999 A *	11/1997	Larson A63H 3/18 206/45.28
5,738,221 A	4/1998	Van Witt et al.
5,791,468 A	8/1998	House
5,817,510 A	10/1998	Pandey et al.
D411,308 S	6/1999	Pandey et al.
D424,296 S	5/2000	David
D424,425 S	5/2000	Ngai
D426,902 S	6/2000	Hardy et al.

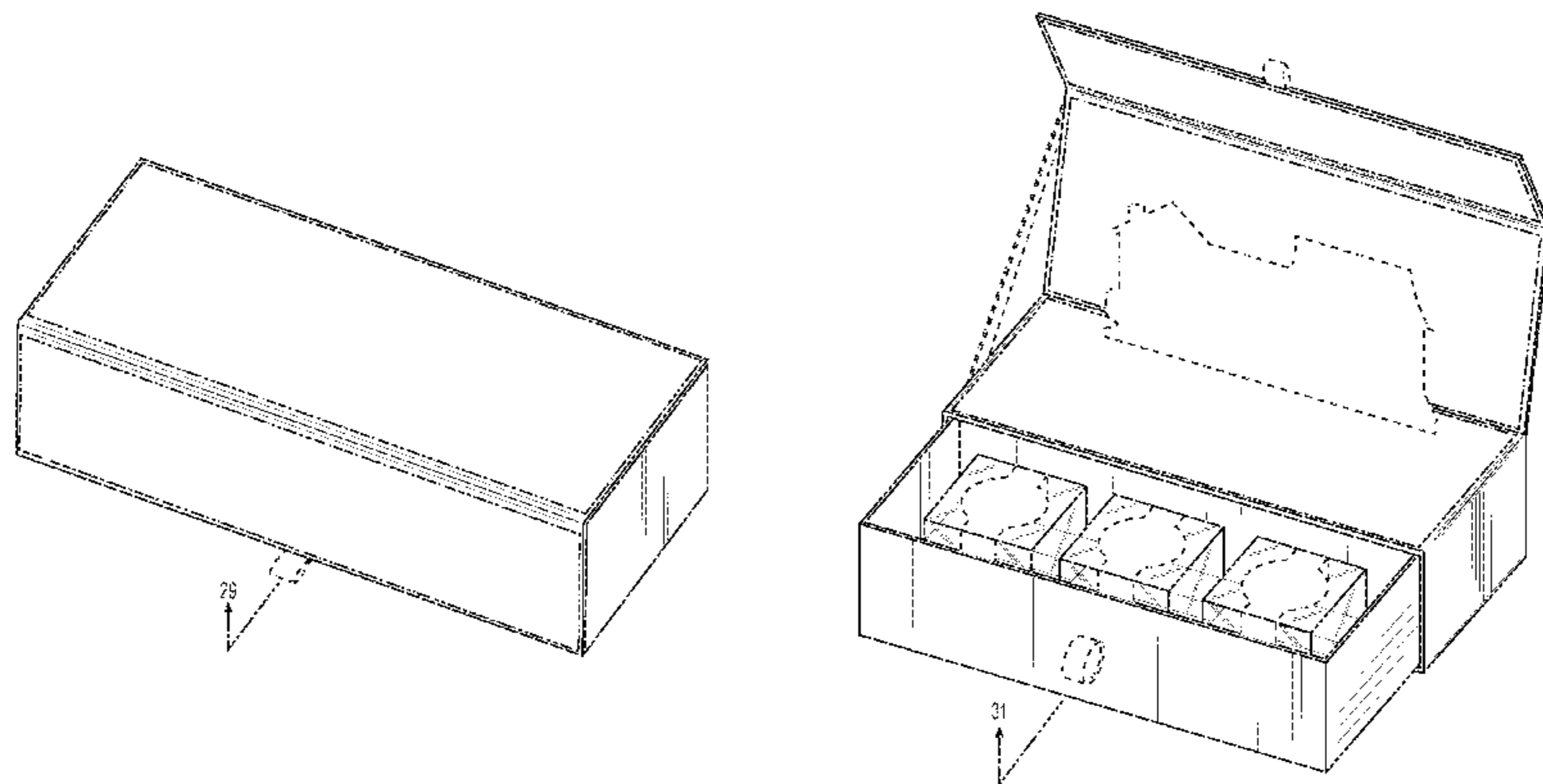

US D829,569 S

Page 2

D433,630 S	11/2000	Lubineau-Bigot et al.	D758,191 S	6/2016	Tu et al.
6,349,820 B1	2/2002	Kelley et al.	D763,104 S	8/2016	Akana et al.
D455,073 S	4/2002	Mizrahi	D763,683 S	8/2016	O'Neill
D464,568 S	10/2002	Sisinni	D763,684 S	8/2016	O'Neill
D464,885 S	10/2002	Weinstein et al.	D764,911 S	8/2016	Glass et al.
D468,100 S	1/2003	Bowling	D768,008 S	10/2016	Akana et al.
6,533,166 B1	3/2003	Kaiss	D769,727 S	10/2016	Lohuis et al.
D477,911 S	8/2003	Stuart	D769,986 S	10/2016	Timg
D492,194 S	6/2004	Kim	D772,057 S	11/2016	Adams et al.
D494,862 S	8/2004	Sisinni	D774,388 S	12/2016	Xia
6,923,556 B1	8/2005	Baker, III	9,533,791 B2	1/2017	Fath
D510,528 S *	10/2005	Funk D9/737	D780,569 S	3/2017	Bard et al.
D511,681 S	11/2005	Cogley et al.	D780,570 S	3/2017	Bard et al.
D521,733 S	5/2006	Kim	D787,186 S	5/2017	Thurbin
D522,376 S	6/2006	Hales	D787,320 S *	5/2017	Gill D9/423
D528,794 S	9/2006	Lanham et al.	D789,752 S	6/2017	Zmrhal et al.
D536,246 S *	2/2007	Schneider D9/432	2002/0108880 A1	8/2002	Krupa et al.
7,264,123 B2	9/2007	Reed	2006/0266672 A1	11/2006	Young
D553,495 S	10/2007	Vandecasteele et al.	2006/0283733 A1	12/2006	Masa
D568,765 S *	5/2008	Miles D9/737	2007/0095693 A1	5/2007	DeLuca
D580,263 S	11/2008	Yi Man	2008/0190788 A1	8/2008	Cziraky
D584,053 S	1/2009	Abdo et al.	2009/0242455 A1	10/2009	Adams et al.
D596,485 S	7/2009	Andre et al.	2010/0012672 A1	1/2010	Piron
D603,720 S	11/2009	Cesare et al.	2010/0187227 A1	7/2010	Wang
D609,116 S	2/2010	Kim	2011/0174166 A1	7/2011	Sparado et al.
7,757,843 B2	7/2010	Katsis	2012/0168434 A1	7/2012	Algarda Cervera et al.
D621,548 S	8/2010	Chen	2012/0168443 A1	7/2012	Maness
D643,306 S	8/2011	Martinez et al.	2013/0161378 A1	6/2013	Nebeker et al.
8,006,842 B1	8/2011	Loughlin, Jr. et al.	2013/0220880 A1	8/2013	Glass et al.
D646,984 S	10/2011	Moore et al.	2013/0240387 A1	9/2013	Pugh
8,109,389 B1	2/2012	Amer	2013/0248531 A1	9/2013	Lane
D657,284 S	4/2012	Young	2014/0021086 A1	1/2014	Roesler
D663,520 S	7/2012	Antler	2014/0166736 A1	6/2014	Kato
D664,312 S	7/2012	Bizzle	2014/0312107 A1	10/2014	Nash
8,272,509 B1	9/2012	McCutchen	2015/0093509 A1	4/2015	Kennedy et al.
D669,352 S	10/2012	Paslowski	2015/0232245 A1	8/2015	Fullan
D670,931 S	11/2012	Tapper	2015/0321811 A1	11/2015	Yeung
D670,932 S	11/2012	Tapper	2016/0009473 A1	1/2016	Korinek et al.
D673,864 S	1/2013	Read et al.	2016/0046404 A1	2/2016	Cheeser et al.
D675,539 S	2/2013	Biglarians	2016/0185511 A1	6/2016	O'Neill
D682,119 S	5/2013	Buford	2017/0050797 A1	2/2017	Farid et al.
D685,578 S	7/2013	Pestell	2017/0076343 A1	3/2017	Bernstein et al.
D686,065 S	7/2013	Kuo et al.	2017/0138660 A1	5/2017	Huckaby et al.
D686,491 S	7/2013	Kuo et al.	2017/0152092 A1	6/2017	Glass et al.
D687,321 S	8/2013	Pralus			
D690,554 S	10/2013	Presley			
D691,465 S	10/2013	O'Brien et al.			
D691,900 S	10/2013	Kraus			
D698,639 S *	2/2014	Fletcher D9/415	EP	2042439 A1	4/2009
D698,664 S	2/2014	Abbott	WO	2017125444 A1	7/2017
D700,462 S	3/2014	Boos			
D704,550 S	5/2014	Mattila et al.			
D706,627 S	6/2014	Olsson et al.			
D709,305 S	7/2014	Tapper			
D709,306 S	7/2014	Tapper			
D709,364 S	7/2014	Olsson et al.			
D712,176 S	9/2014	Tamilarasan			
D712,748 S	9/2014	Akana et al.			
D713,739 S	9/2014	Akana et al.			
D717,165 S	11/2014	Kwak et al.			
D722,870 S	2/2015	Fohner et al.			
D728,358 S	5/2015	Belamich			
D729,636 S	5/2015	Steinberger			
D730,749 S *	6/2015	Young D9/759			
D731,323 S	6/2015	O'Neill			
D731,325 S	6/2015	Loessin			
D733,314 S	6/2015	Lui			
D733,315 S	6/2015	Lui			
D733,317 S	6/2015	Lui			
D733,318 S	6/2015	Lui			
9,061,790 B2	6/2015	Yagishita			
D734,075 S	7/2015	Tapper			
D738,721 S	9/2015	Song et al.			
D741,193 S	10/2015	Lohuis et al.			
D748,280 S	1/2016	Lui			
D754,408 S	4/2016	Garrett et al.			
D755,641 S	5/2016	O'Neill			
D756,560 S	5/2016	Ghiotti et al.			
D756,804 S	5/2016	Gross			

FOREIGN PATENT DOCUMENTS

EP	2042439 A1	4/2009
WO	2017125444 A1	7/2017

OTHER PUBLICATIONS

Sugarfina Partners With Sanrio to Create the Cutest Hello Kitty Candy on the Planet. [online] Published Sep. 17, 2017. Retrieved Nov. 20, 2017 from URL: <<https://www.popsugar.com/food/photo-gallery/44018877/image/44018885/Sugarfinas-Pop-Up-Candy-Bento-Box-30>>.*

Rigid Set-up Box, Wine and Champagne Chocolate Leather Gift Box, Faux Leather, Dark Brown, QTY/CASE-6. [online] Retrieved Nov. 22, 2017 from URL: <<https://www.aspecialtybox.com/RG00F-00493-C>>.*

House Drawer Gift Box/CMXSSGB-010. [online] Retrieved Nov. 22, 2017 from URL: <<http://www.charmpackaging.com/special-shape-gift-box/house-drawer-gift-box-cmxssg-b-010.html>>.*

Bouquet Bar 3 Piece Box Photo—Instagram—<https://www.instagram.com/p/BPs-h6rBWic/?taken-by=thebouquetbar>; Jan. 25, 2017, 1 page.

Bouquet Bar 6 Piece Box Photo—“It’s Time to Ditch the Red Roses: Six Better Ways to Give Your Valentine Flowers,” People Home & Travel; Jan. 31, 2017, 10 pages.

Bouquet Bar 6 Piece Photo—Instagram—<https://www.instagram.com/p/BP-9I12hV9Q/?taken-by=thebouquetbar>; Feb. 1, 2017, 1 page.

Chocomize 2 Piece Box—<https://www.chocomize.com/candy-cubes-2pack.html>; Oct. 16, 2017, 4 pages.

- Chocomize 3 Piece Box Photo—Facebook—<https://www.facebook.com/Chocomize/photos/a.423529781180.220124.176532311180/10154561729211181/?type=3&theater>; Nov. 11, 2016, 1 page.
- Chocomize 6 Piece Box—<https://www.chocomize.com/candy-cube-6pcs-box.html>; Oct. 16, 2017, 3 pages.
- Chocomize 9 Piece Box Photo—Instagram—<https://www.instagram.com/p/BI5r4s6BLH7/?taken-by=chocomize>; Aug. 9, 2016, 1 page.
- Chocomize 9 Piece Box Photo—Instagram—<https://www.instagram.com/p/BMpjEEUhpqV/?taken-by=chocomize>; Nov. 10, 2016, 1 page.
- Chocomize 9 Piece Box Photo—Instagram—<https://www.instagram.com/p/BMrp0YdhQeU/?taken-by=chocomize>; Nov. 11, 2016, 1 page.
- Cubetas 2 Piece and 3 Piece Box Photo—Instagram—<https://www.instagram.com/p/BMyWwq0BQoH/?taken-by=cubetas.2016>; Nov. 14, 2016, 1 page.
- Cubetas 2 Piece and 3 Piece Box Photo—Instagram—<https://www.instagram.com/p/BNtkhJpBzYm/?taken-by=cubetas.2016>; Dec. 7, 2016, 1 page.
- Cubetas 2 Piece Box Photo—Instagram—<https://www.instagram.com/p/BMQ9Bjihqyz/?taken-by=cubetas.2016>; Nov. 1, 2016, 1 page.
- Cubetas 3 Piece Box Photo—Instagram—<https://www.instagram.com/p/BPrxqTThloh/?taken-by=cubetas.2016>; Jan. 25, 2017, 1 page.
- Foxes Events 6 Piece Box Photo—Instagram—<https://www.instagram.com/p/BQVMWj7jZke/?taken-by=foxesevents&hl=en>; Feb. 10, 2017, 1 page.
- Idea Stage 2 Piece Box—<https://www.ideastage.com/Cube-Shaped-Candy-Set-965458328>; Oct. 13, 2017, 2 pages.
- Sugarwish 2 Piece and 4 Piece Boxes—<https://web.archive.org/web/20151201071311/https://sugarwish.com/choose-a-sugarwish>; Dec. 1, 2015, 1 page.
- Sweet Lounge 2 Piece Box—<https://www.sweetlounge.co.uk/lounge-box-hello-spring-collection-for-vegans/>; Oct. 16, 2017, 6 pages.
- Sweet Lounge 3 Piece and 4 Piece Box Photo—Instagram—https://www.instagram.com/p/Bm_eHn6g8ly/?taken-by=sweetloungeuk; Nov. 19, 2016, 1 page.
- Sweet Lounge 3 Piece and 4 Piece Box Photo—Instagram—https://www.instagram.com/p/Bmy_iidAMwX/?taken-by=sweetloungeuk; Nov. 4, 2016, 1 page.
- Sweet Lounge 4 Piece Box—Instagram—<https://www.instagram.com/p/BNMnfaJgwOo/?taken-by=sweetloungeuk>; Nov. 24, 2016, 1 page.
- Sweet Lounge 4 Piece Box—<https://www.sweetlounge.co.uk/lounge-box-hello-spring-collection/>; Oct. 16, 2017, 7 pages.
- Sweet Lounge 4 Piece Box Video Snapshots—Facebook—<https://www.facebook.com/sweetloungeuk/videos/vb.670728213008752/1188285557919679/?type=2&theater>; Nov. 16, 2016, 6 pages.
- Sweet Pete's 8 Piece Box—www.sweetpetescandy.com/collections/create-a-box; Nov. 18, 2016, 2 pages.
- Sweitzer Candy 3 Piece Box Photo—Instagram—<https://www.instagram.com/p/440XveluqO/?taken-by=sweitzercandy>; Jul. 8, 2015, 1 page.
- Sweitzer Candy 4 Piece Box Photo—Instagram—<https://www.instagram.com/p/440XveluqO/?taken-by=sweitzercandy>; Apr. 16, 2015, 1 page.
- Sweitzer Candy 8 Piece Box Photo—Instagram—<https://www.instagram.com/p/wLDm8Olujs/?taken-by=sweitzercandy>; Dec. 4, 2014, 1 page.
- Webb Company 2 Piece Box Photo—Facebook—<https://www.facebook.com/webbcollection/photos/a.376918812240.156708.376836382240/10154628557212241/?type=3&theater>; Oct. 18, 2016, 1 page.
- Webb Company 4 Piece Box—<https://www.facebook.com/webbcollection/photos/a.376918812240.156708.376836382240/10154602255037241/?type=3&theater>; Oct. 11, 2016, 1 page.
- Weeny Beeny 3 Piece Box Photo—Facebook—<https://www.facebook.com/weenyweeny123/>; Jan. 31, 2017, 1 page.
- Weeny Beeny 4 Piece Box Photo—Facebook—<https://www.facebook.com/weenyweeny123/>; Jan. 31, 2017, 1 page.
- Bonbonist Box Photo—Facebook—<https://www.facebook.com/thebonbonist/photos/a.1493876617357861.1073741829.1290401221038736/1493876580691198/?type=3&theater>; Oct. 1, 2017, 1 page.
- Bonbonist—<https://thebonbonist.com/>; Oct. 18, 2017, 4 pages.
- Chocomize, Candy Cube Boxes, www.chocomize.com/candy-cube-box-9pc.html (Jun. 29, 2017).
- MidNite Snax, Signature Sets, http://midnitesnax.com/home_page_files/view/1265/file.pdf (Jun. 29, 2017).
- Sweet Pete's, Build-a-Candy-Cube-Box, <https://www.sweetpetescandy.com/collections/build-a-candy-cube-box> (Jun. 29, 2017).
- Sweet Pete's, Pete's Picks Collection, www.sweetpetescandy.com:80/collections/boxes (Mar. 23, 2016).
- Sweitzer Candy Shop, Gifts, <https://sweitzercandy.com/index.php/gift-boxes.html> (Jun. 29, 2017).
- Sugarfina, Design Your Own Bento, www.sugarfina.com/shop/gift-shop/gift-type/design-your-own-bento (Jun. 29, 2017).
- Sugarfina, Custom Catalogue, <https://issuu.com/sugarfina/docs/2017-corporatecatalog-ppai-webversi> (Jun. 29, 2017).
- Teapressa, Tea + Cube, available at <https://teapressa.com/collections/gifts/products/tea-cube> (Jun. 29, 2017).
- Sweitzer Candy Gift Box 8, available Feb. 21, 2015, [online], [site visited Aug. 2, 2017]. Available from Internet, <URL: <https://web.archive.org/web/20150221225755/https://sweitzercandy.com/index.php/gift-boxes.html>, 2 pages.
- Sweitzer Candy Gift Box 4, available Feb. 21, 2015, [online], [site visited Aug. 2, 2017]. Available from Internet, <URL: <https://web.archive.org/web/20150221225755/https://sweitzercandy.com/index.php/gift-boxes.html>, 2 pages.
- "A Taste of Paradise," Collection by Sugarfina, available Aug. 2, 2017, [online], [site visited Aug. 2, 2017]. Available from internet, <URL: <https://www.sugarfina.com>, 1 page.
- Cubetas, [online], [site visited Aug. 16, 2017]. Available from Internet, <URL: <http://cubetas.jp/>>, 19 pages.
- International Search Report and Written Opinion for International Application No. PCT/US2017/057660 dated Jan. 25, 2018, 9 pages.
- Beach Picnic Image (Date Unknown), 1 page.
- Sugarfina Representative Twitter posts; <https://twitter.com/sugarfina>; 8 pages.
- Sugarfina Representative Facebook posts; <https://www.facebook.com/Sugarfina>; 25 pages.
- Sugarfina Representative Instagram posts; <https://www.instagram.com/sugarfina/?hl=en>; 40 pages.
- Sugarfina: Sampling the Sweets—York Avenue; <https://yorkavenueblog.com/sugarfina-sampling-sweets/>; Sep. 8, 2014; 7 pages.
- Sugarfina—Candy Happiness!; <http://luluandlattes.com/2013/06/27/sugarfina-candy-happiness/>; Jun. 27, 2013; 11 pages.
- Kasey's Kitchen: Kasey's Favorite Thing #20: Sugarfina; <http://kaseyskitchentv.blogspot.com/2013/12/kaseys-favorite-thing-20-sugarfina.html>; Dec. 17, 2013; 3 pages.
- Jonathan Adler Sugarfina Bento Boxes_InStyle.com; <http://www.instyle.com/lifestyle/news/sugarfina-loves-jonathan-adler-collection>; Apr. 11, 2016; 2 pages.
- Fancy candy brand selects fancier Dallas destination for Texas debut; <http://dallas.culturemap.com/news/restaurants-bars/10-29-15-sugarfina-highland-park-village-market-candy/>; Oct. 29, 2015; 4 pages.
- Emiiichan Blog_Sugarfina candy order; <https://emiiichan.blogspot.com/2014/11/sugarfina-candy-order.html>; Nov. 21, 2014, 18 pages.
- Drool Worthy Sweets in Cute Packaging Beckon at Sugarfina Candy Shop; <http://www.7x7.com/drool-worthy-sweets-in-cute-packaging-beckon-at-sugarfina-candy-shop-1787196138.html>; Jul. 15, 2015; 4 pages.
- Candy Critic: Boxes and Boxes of Gummies From Sugarfina; <http://candy-critic.blogspot.com/2013/05/boxes-and-boxes-of-gummies-from.html>; May 2, 2013; 2 pages.
- Sugarfina Part I—Foodette Reviews; <http://foodettereviews.com/?p=24>; Sep. 10, 2013; 7 pages.
- Rebecca's Delights: Sugarfina Gourmet Candy—Author Rebecca Kelsey Sampson; <http://rebeccakelsey.com/2012/11/rebeccas-delights-sugarfina-gourmet-candy>; Nov. 12, 2012; 6 pages.
- Sugar & Charm // Sugarfina—Mary Costa Photography; <http://marycostaphotography.com/sugar-charm-sugarfina/>; Apr. 22, 2014; 24 pages.
- Treat yourself: Sugarfina!_Twinkie Chan Blog; <http://blog.twinkiechan.com/2012/09/20/treat-yourself-sugarfina/>; Sep. 20, 2012; 13 pages.
- Sugarfina << MDH Mark D Hogan; <https://markdhogan.wordpress.com/tag/sugarfina/>; Aug. 29, 2013; 7 pages.

Sugarfina (Beverly Hills, CA) • The Episodic Eater; <https://www.theepisodiceater.com/sugarfina-beverly-hills-ca/>; unknown date; 29 pages.

Sugarfina—A Unique Candy Boutique at The Americana; <http://www.realmomofsfv.com/2014/06/18/sugarfina-a-unique-candy-boutique-at-the-americana/>; Jun. 18, 2014; 28 pages.

Sugarfina—Thrillist LA; <https://www.thrillist.com/eat/los-angeles/we-fed-a-kid-absinthe-candy-here-s-what-happened-thrillist-la>; Dec. 16, 2013; 35 pages.

A Sweet Evening at Sugarfina—SavvySleepers; <https://www.savvysleepers.com/blogs/the-benefits-of-satin/44181636-a-sweet-evening-at-sugarfina>; Aug. 31, 2015; 7 pages.

Sugarfina: The Chocolates—Candy Blog; http://www.candyblog.net/blog/item/sugarfina_the_chocolates; Jul. 16, 2013; 11 pages.

Sugarfina Beverly Hills & Trio of Goodies—Candy Blog; http://www.candyblog.net/blog/item/sugarfina_trio_of_goodies; Dec. 16, 2013; 11 pages.

Sugarfina: The Gummies—Candy Blog; http://www.candyblog.net/blog/item/sugarfina_the_gummies; Jul. 10, 2013; 11 pages.

NYC Guide: Sugarfina—York Avenue; <https://yorkavenueblog.com/nyc-guide-sugarfina/>; Oct. 26, 2015; 74 pages.

Talking Shop: Sugarfina—Sugar Paper; <https://sugarpaper.com/blogs/news/87503553-talking-shop-sugarfina>; Feb. 11, 2016; 13 pages.

A Candy Emporium for Adults; <https://www.entrepreneur.com/article/236286>; Aug. 25, 2014; 10 pages.

10 fanciest candies from Sugarfina's New York shop—NY; <http://www.nydailynews.com/life-style/eats/10-fanciest-candies-sugarfina-new-york-shop-article-1.2407237>; Oct. 22, 2015; 9 pages.

People Freaked Out So Hard Trying to Get Rosé Gummy Bears that They Crashed the Website; <https://www.forbes.com/sites/meghancasserly/2013/04/09/sugarfina-facebook-candy-shop-outerspace/#78cb39dd6e74>; Jun. 29, 2016; 14 pages.

Sugarfina: One Candy-Coated Startup's Plans for a Lucrative Exit—But First a Trip to Space; <https://www.forbes.com/sites/meghancasserly/2013/04/09/sugarfina-facebook-candy-shop-outerspace/#78cb39dd6e74>; Apr. 9, 2013; 6 pages.

Luxurious One-of-a-Kind Candy Shop Tour With Sugarfina—Best Friends for Frosting; <https://bestfriendsforfrosting.com/2015/11/luxurious-one-kind-candy-sugarfina/>; Nov. 17, 2015; 16 pages.

Sugarfina Launches—Atlanta's Lenox Square Just Got Sweeter!; <http://www.momsmagicalmiles.com/sugarfinalaunches-atlantas-lenox/>; Nov. 6, 2015; 15 pages.

Whispering Angel Rosé-Infused Gummy Bears are Summer's Hottest Sweet—The Glamorous Gourmet; <https://theglamorousgourmet.com/whispering-angel-rose-gummy-bears-summers-hottest-sweet/>; Jul. 31, 2016; 13 pages.

Sugar Fix: Sugarfina Pasadena; <https://studiodiy.com/2015/07/21/sugar-fix-sugarfina-pasadena/>; Jul. 21, 2015; 15 pages.

Rosie O'Neill of Sugarfina—The Everygirl; <http://theeverygirl.com/rosie-oneill-of-sugarfina>; May 18, 2014; 27 pages.

White Two Piece Gift Box (Exact Date Unknown); believed available as of Aug. 2012; 1 page.

Colored Deluxe Two Piece Gift Boxes (Exact Date Unknown); believed available as of Aug. 2012; 10 pages.

Clear Flush-Lid Amac Boxes (Exact Date Unknown); believed available as of Feb. 27, 2010; 10 pages.

* cited by examiner

Primary Examiner — Vy N Koenig

(74) Attorney, Agent, or Firm — Troutman Sanders LLP;
Alexis N. Simpson; Micah B. Hensley

(57) **CLAIM**

The ornamental design for a packaging, as shown and described.

DESCRIPTION

FIG. 1 is a front perspective view of a packaging showing my new design, shown with the top and drawer closed.

FIG. 2 is a front view thereof.

FIG. 3 is a rear view thereof.

FIG. 4 is a left view thereof.

FIG. 5 is a right view thereof.

FIG. 6 is a top view thereof.

FIG. 7 is a bottom view thereof.

FIG. 8 is a front perspective view thereof, shown with the top open for clarity of illustration.

FIG. 9 is a front view thereof, shown with the top open for clarity of illustration.

FIG. 10 is a back view thereof, shown with the top open for clarity of illustration.

FIG. 11 is a left view thereof, shown with the top open for clarity of illustration.

FIG. 12 is a right view thereof, shown with the top open for clarity of illustration.

FIG. 13 is a top view thereof, shown with the top open for clarity of illustration.

FIG. 14 is a bottom view thereof, shown with the top open for clarity of illustration.

FIG. 15 is a front perspective view thereof, with the top and drawer open for clarity of illustration, and showing cubes in the drawer.

FIG. 16 is a front view thereof, with the top and drawer open for clarity of illustration, and showing cubes in the drawer.

FIG. 17 is a back view thereof, with the top and drawer open for clarity of illustration, and showing cubes in the drawer.

FIG. 18 is a left view thereof, with the top and drawer open for clarity of illustration, and showing cubes in the drawer.

FIG. 19 is a right view thereof, with the top and drawer open for clarity of illustration, and showing cubes in the drawer.

FIG. 20 is a top view thereof, with the top and drawer open for clarity of illustration, and showing cubes in the drawer.

FIG. 21 is a bottom view thereof, with the top and drawer open for clarity of illustration, and showing cubes in the drawer.

FIG. 22 is a front perspective view thereof, with the top and drawer open for clarity of illustration, shown without cubes in the drawer.

FIG. 23 is a front view thereof, with the top and drawer open for clarity of illustration, shown without cubes in the drawer.

FIG. 24 is a back view thereof, with the top and drawer open for clarity of illustration, shown without cubes in the drawer.

FIG. 25 is a left view thereof, with the top and drawer open for clarity of illustration, shown without cubes in the drawer.

FIG. 26 is a right view thereof, with the top and drawer open for clarity of illustration, shown without cubes in the drawer.

FIG. 27 is a top view thereof, with the top and drawer open for clarity of illustration, shown without cubes in the drawer.

FIG. 28 is a bottom view thereof, with the top and drawer open for clarity of illustration, shown without cubes in the drawer.

FIG. 29 is a cross-sectional view thereof, shown with the top and drawer closed merely for clarity of illustration, bisecting the packaging as reflected in FIG. 1.

FIG. 30 is a cross-sectional view thereof, shown with the top open merely for clarity of illustration, bisecting the packaging as reflected in FIG. 8.

FIG. 31 is a cross-sectional view thereof, shown with the top and drawer open and with cubes in the drawer merely for clarity of illustration, bisecting the packaging as reflected in FIG. 15; and,

FIG. 32 is a cross-sectional view thereof, shown with the top and drawer open and without cubes in the drawer merely for clarity of illustration, bisecting the packaging as reflected in FIG. 22.

The broken lines shown represent unclaimed subject matter and form no part of the claimed design. The shade lines shown represent surface shading and not surface ornamentation, color, or material type. The dot-dashed boundary lines shown do not form part of the claimed design. The bounds of the claimed design are defined with dot-dashed boundary lines when the boundary does not exist in reality in the article embodying the design.

1 Claim, 32 Drawing Sheets

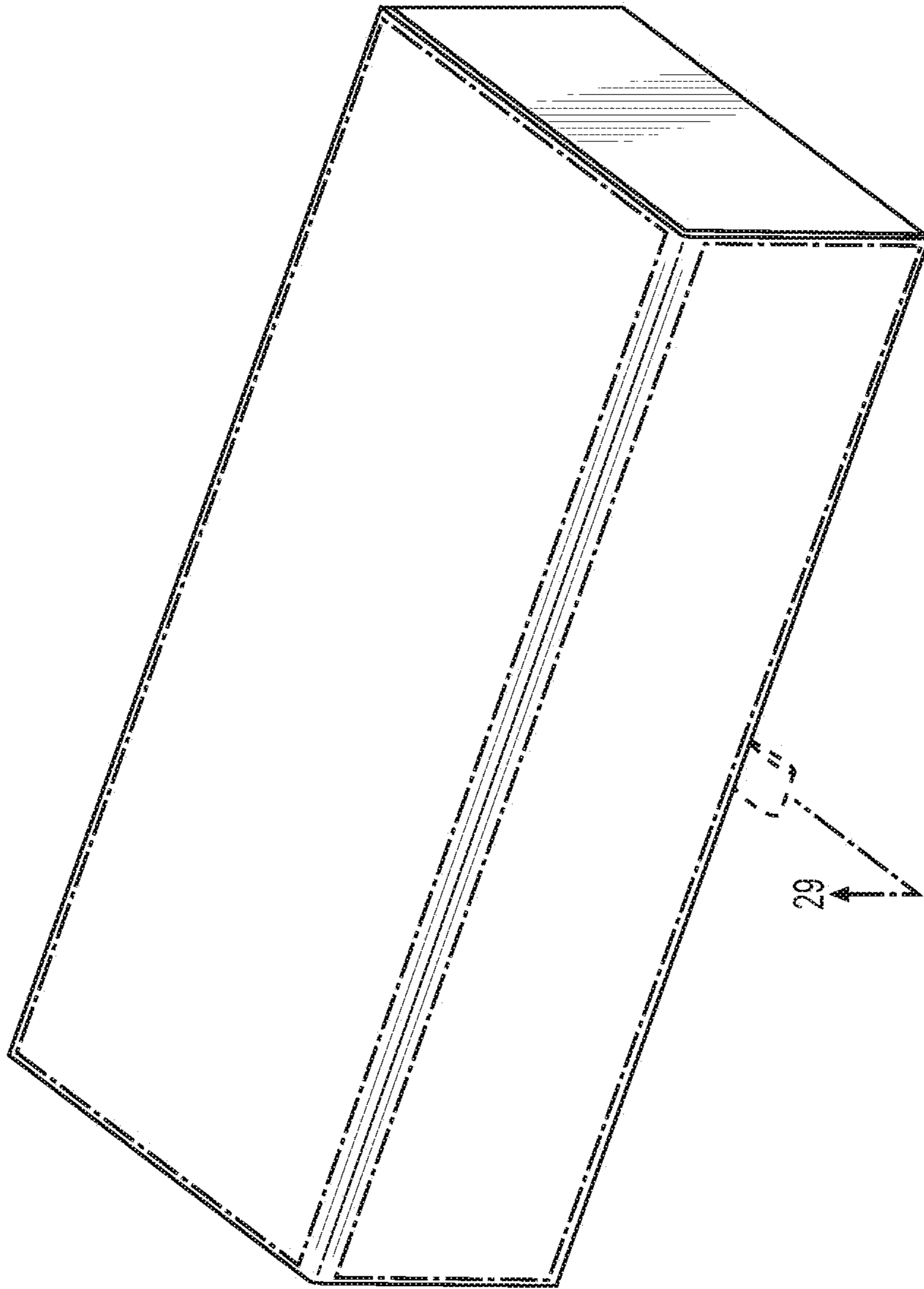

FIG. 1

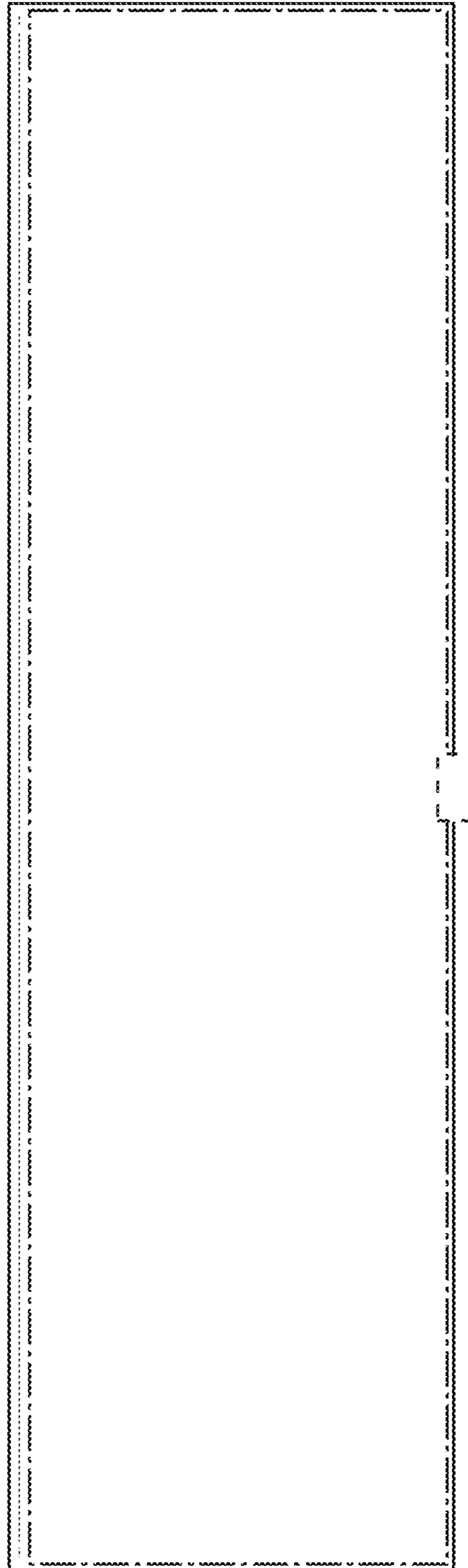

FIG. 2

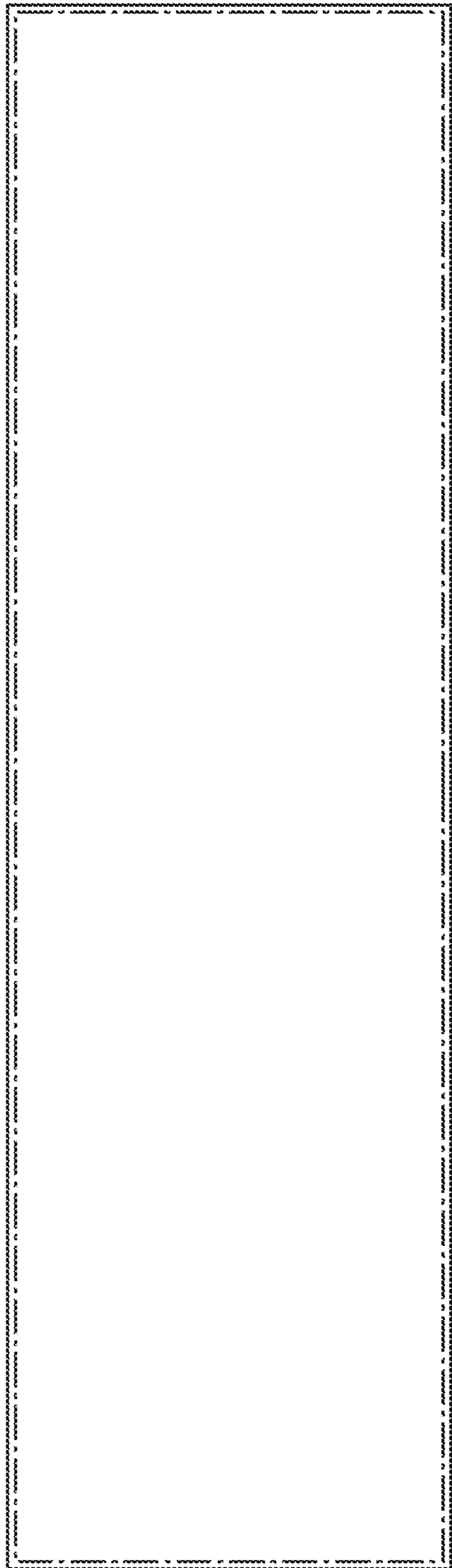

FIG. 3

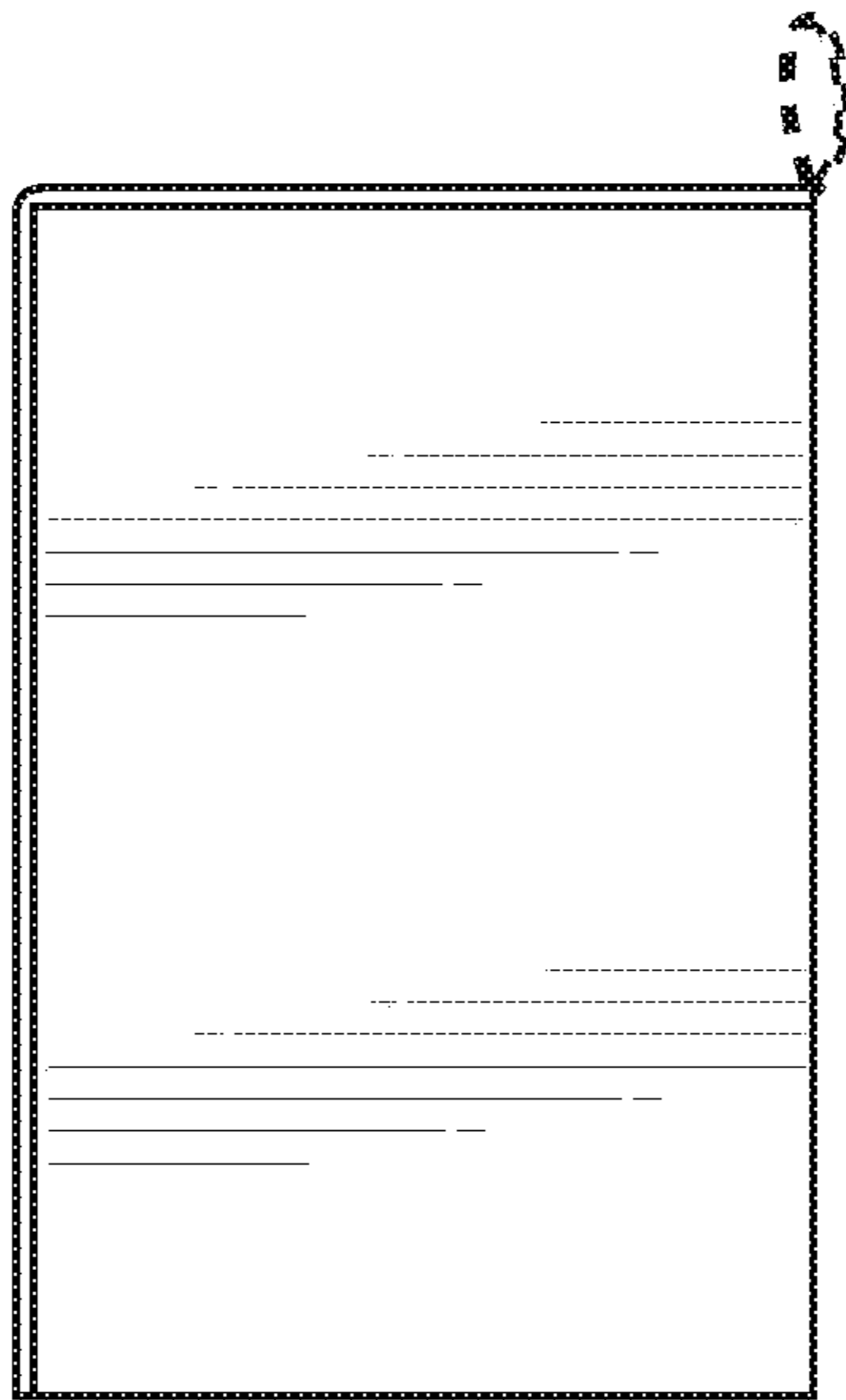

FIG. 4

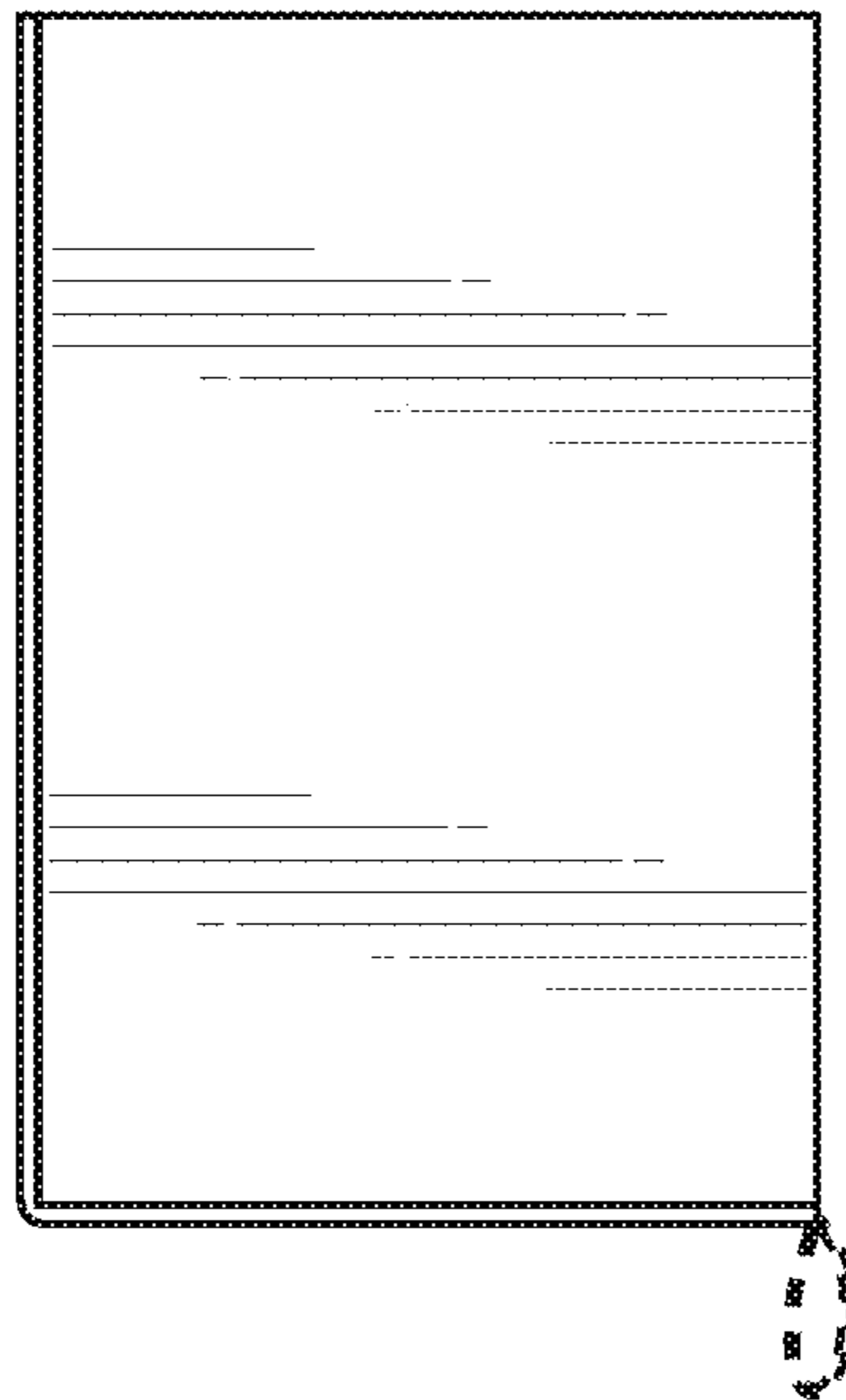

FIG. 5

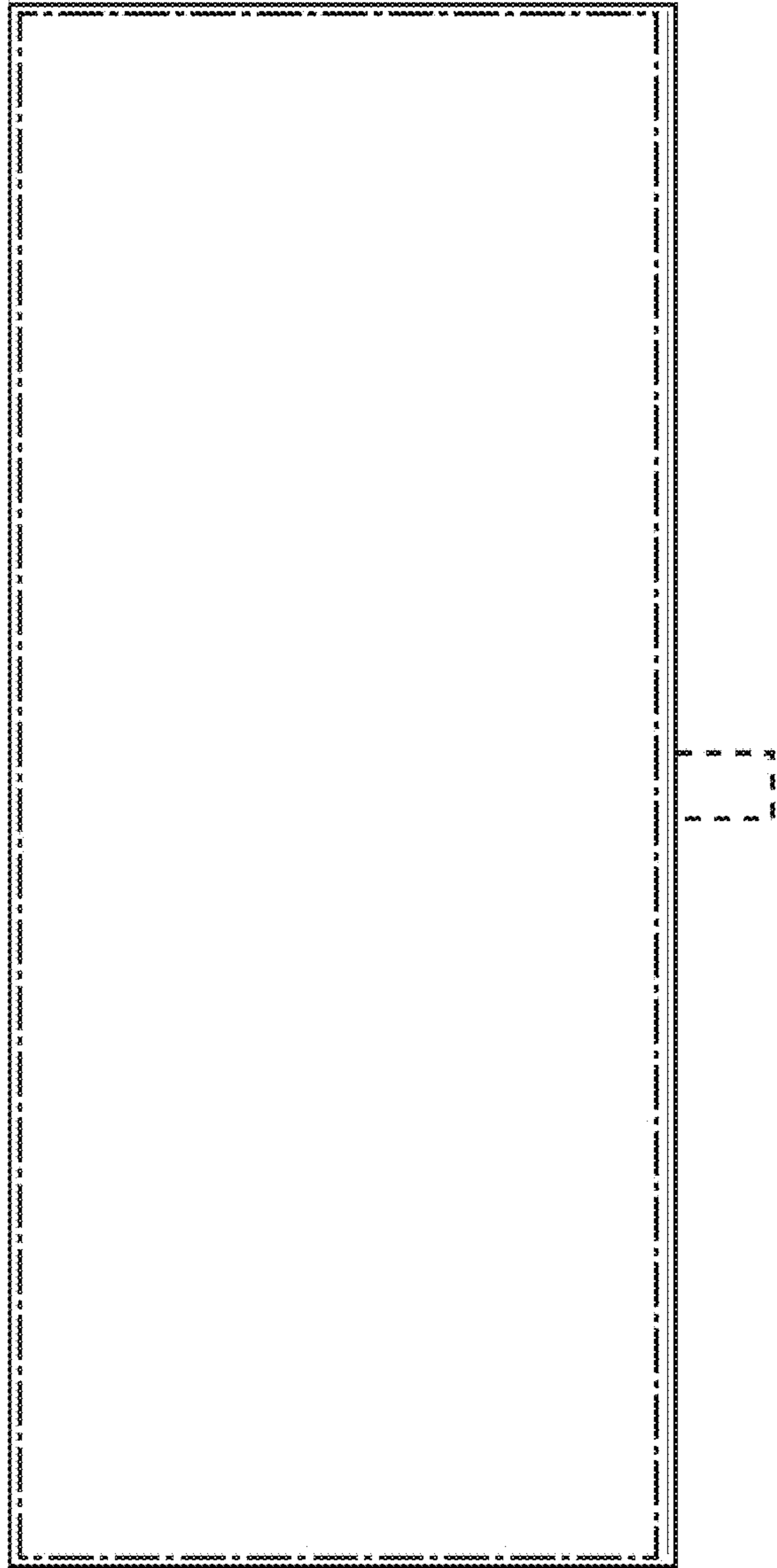

FIG. 6

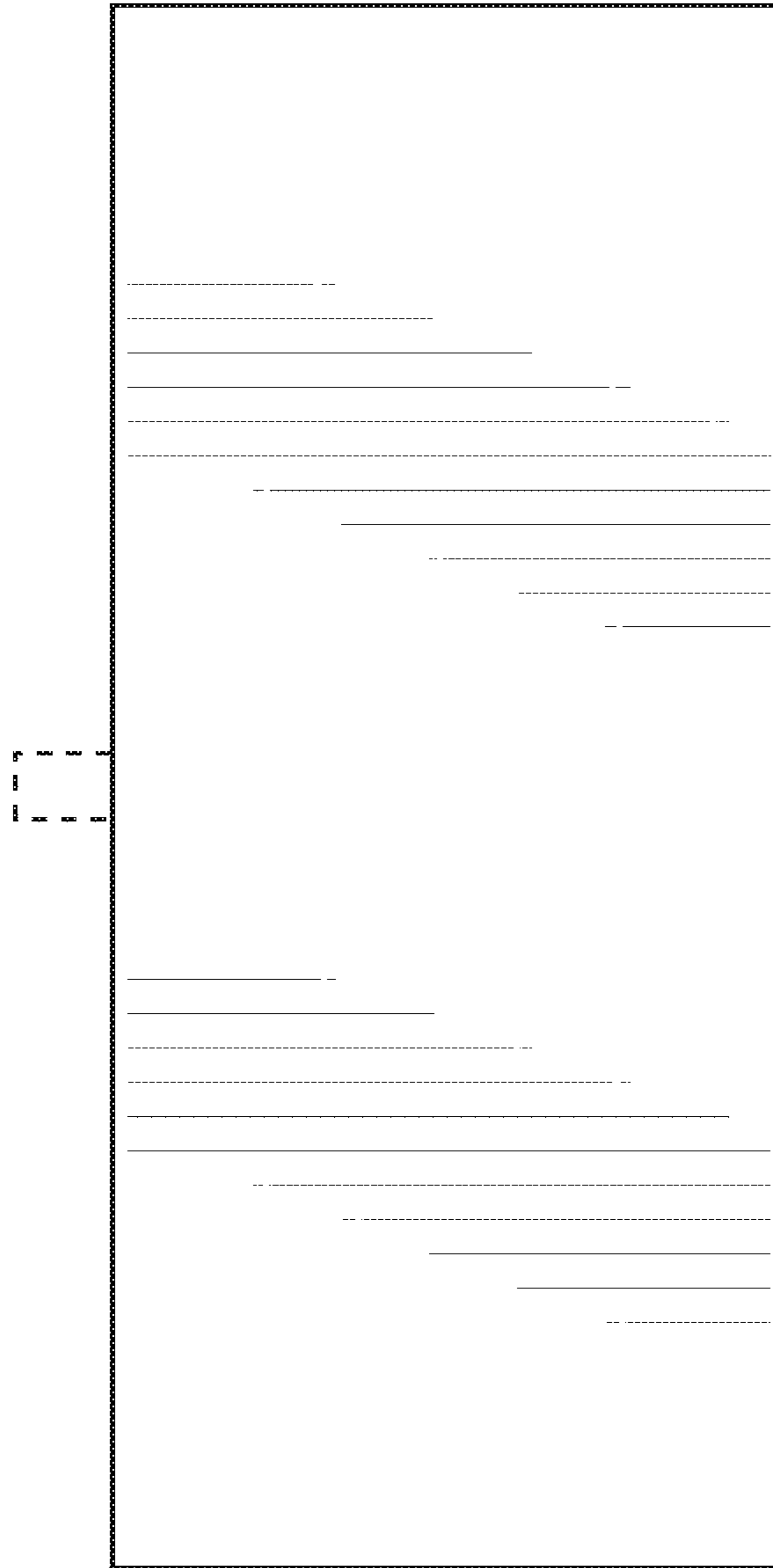

FIG. 7

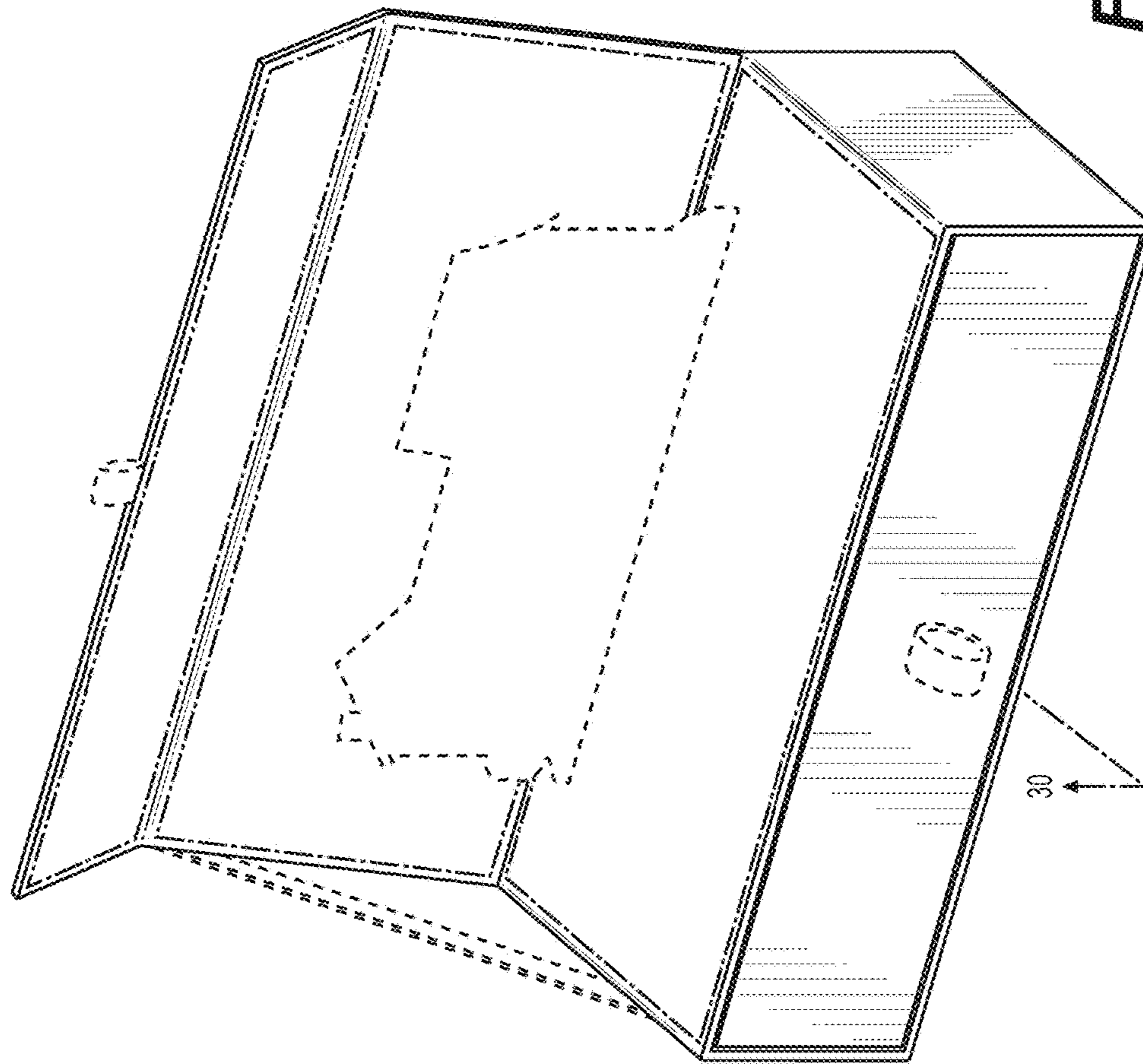

FIG. 8

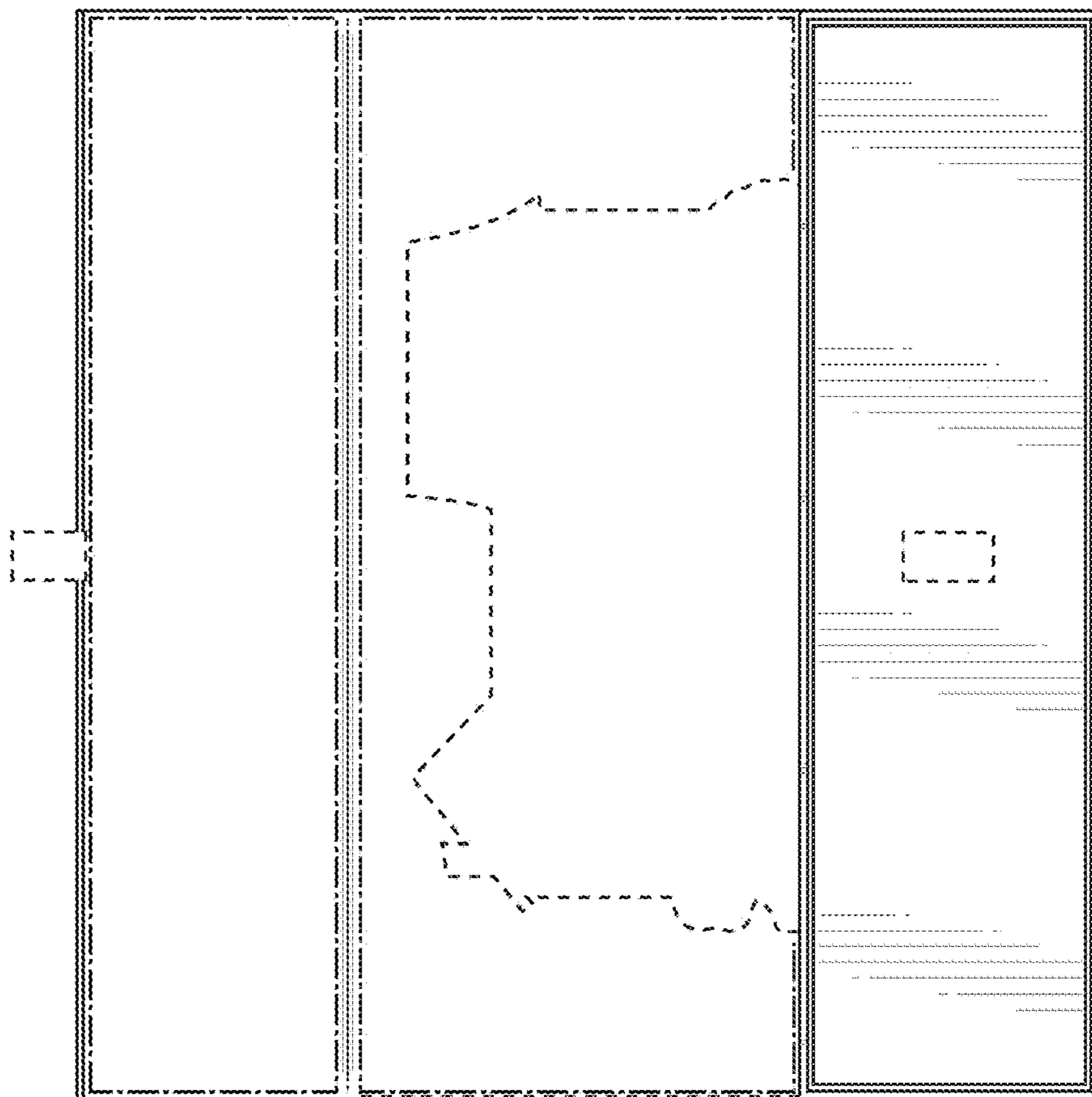

FIG. 9

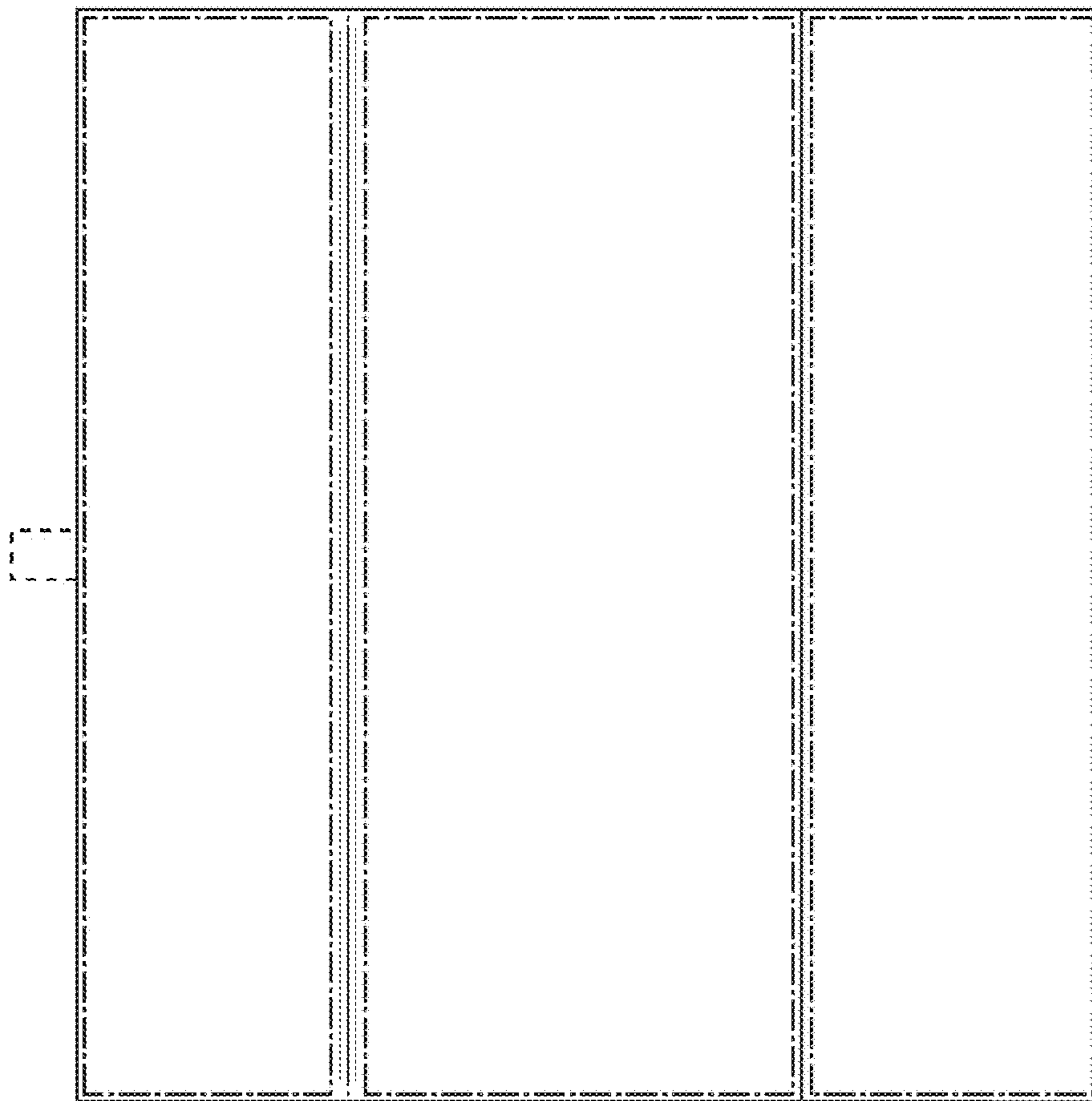

FIG. 10

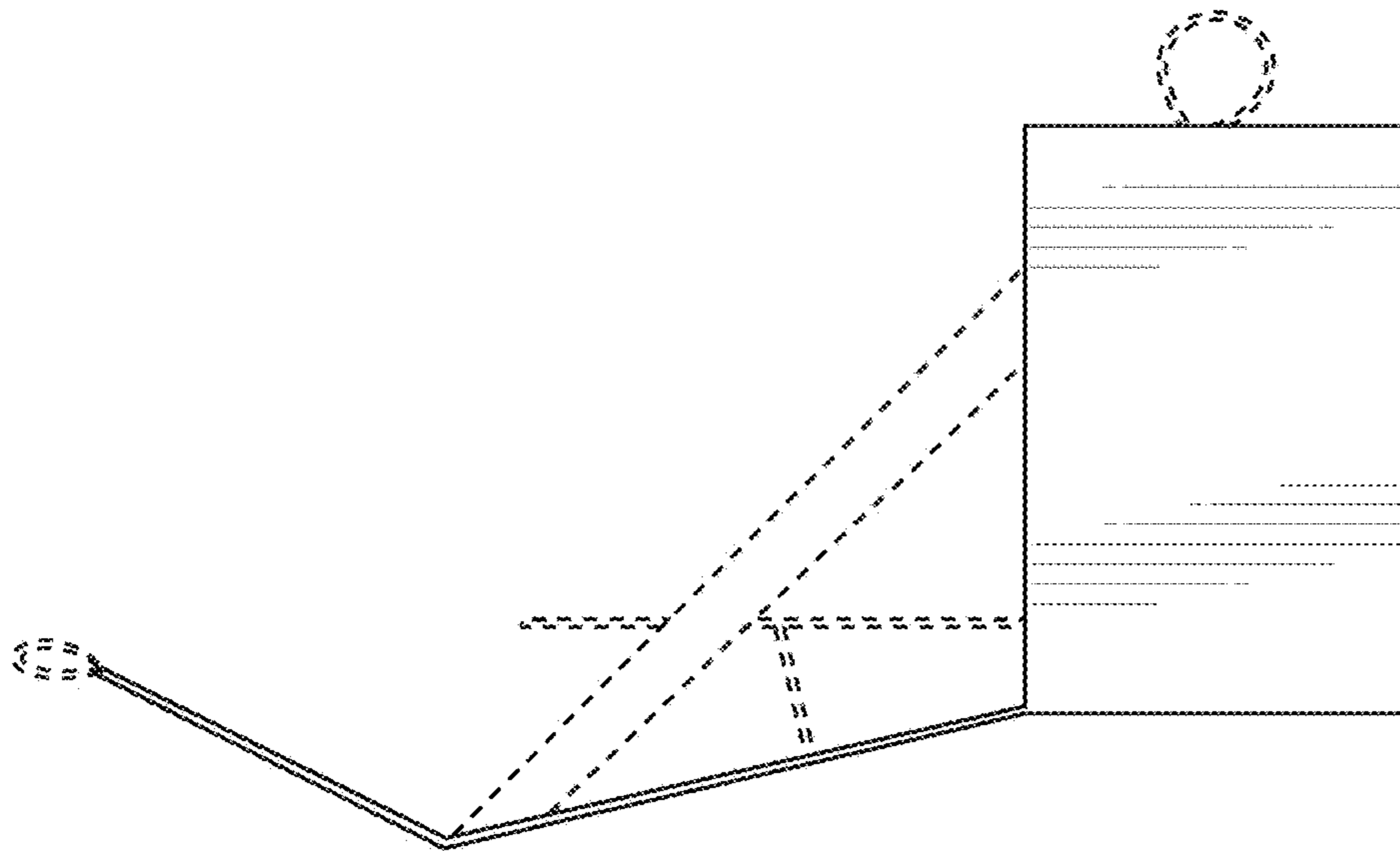

FIG. 11

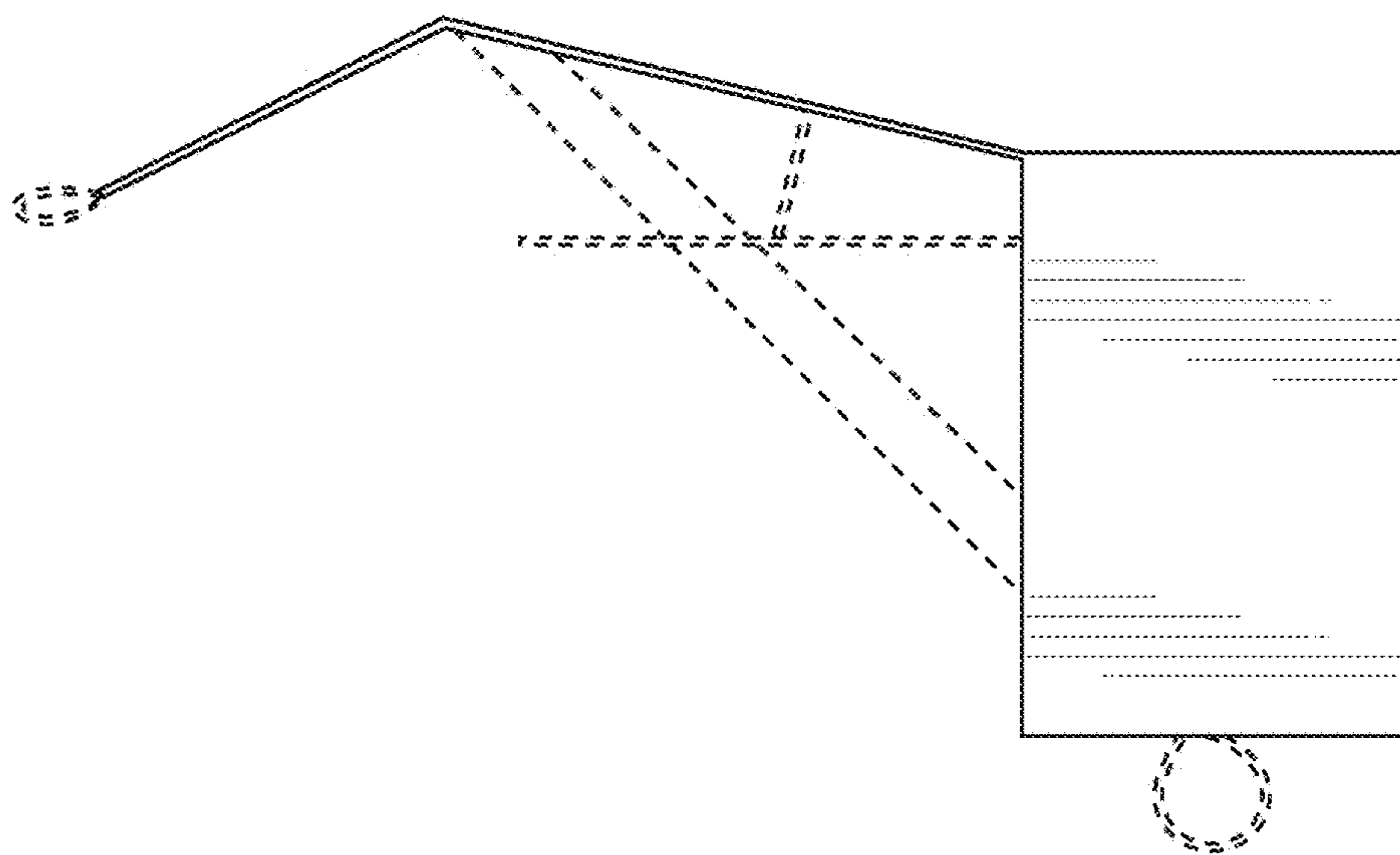

FIG. 12

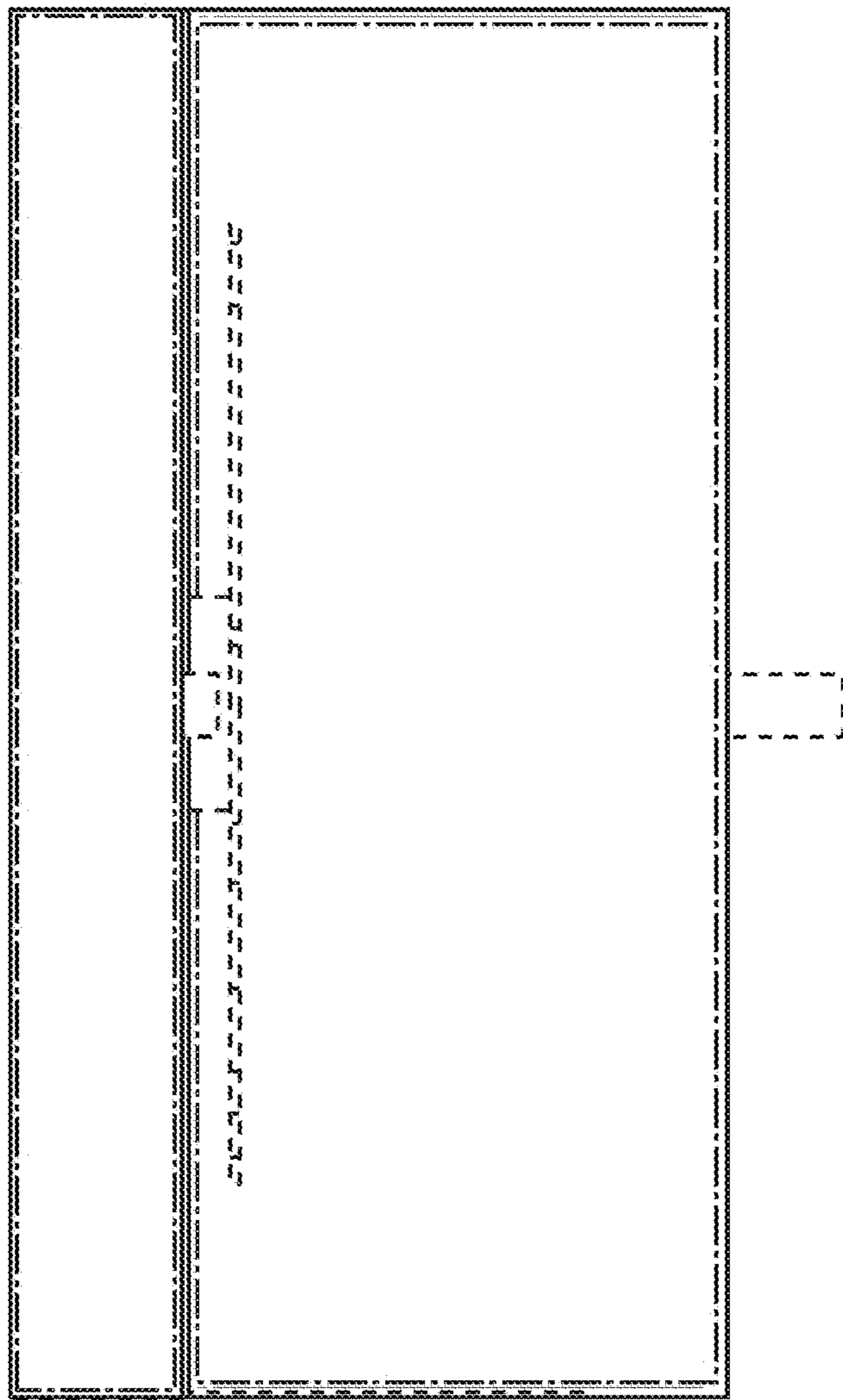

FIG. 13

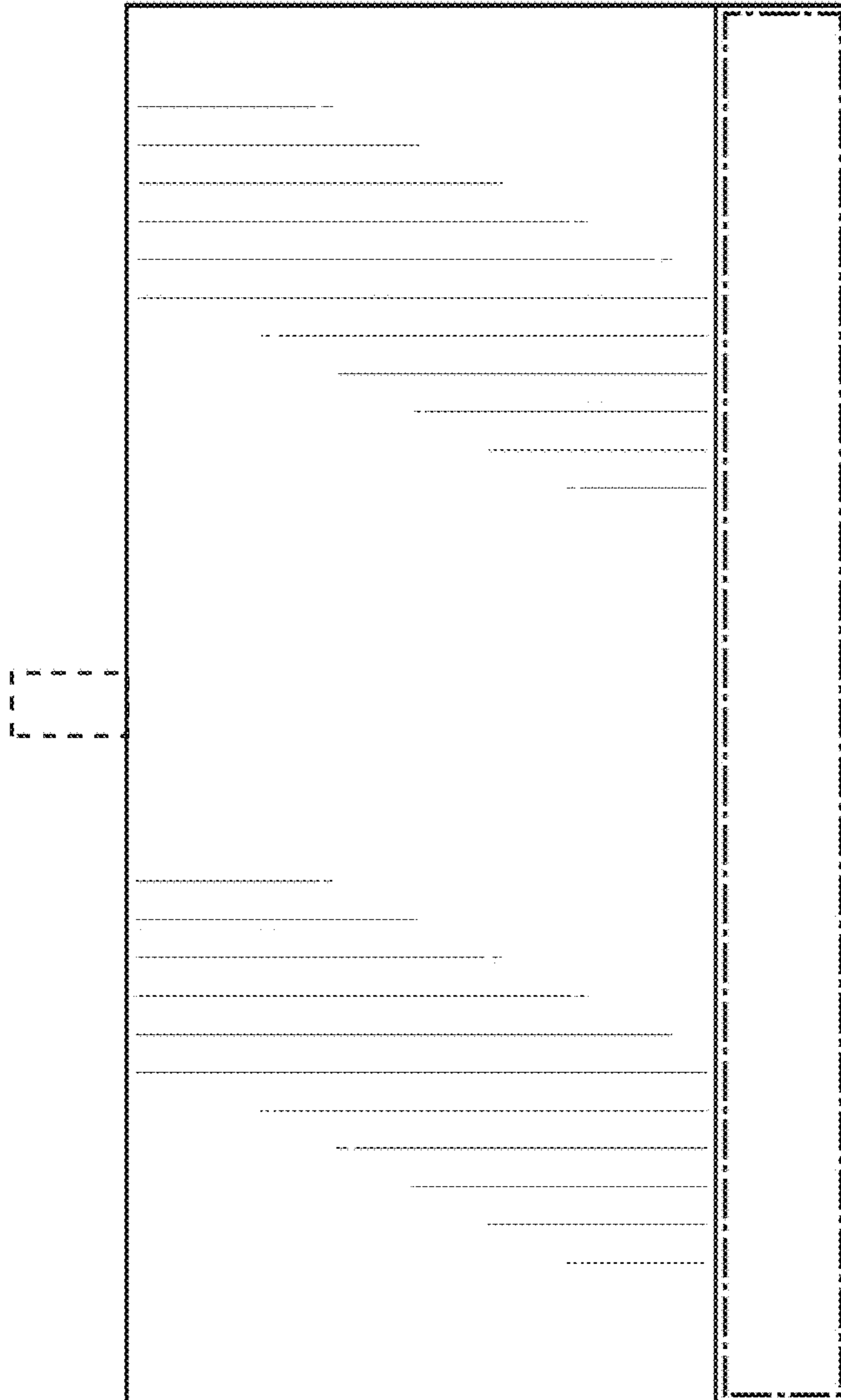

FIG. 14

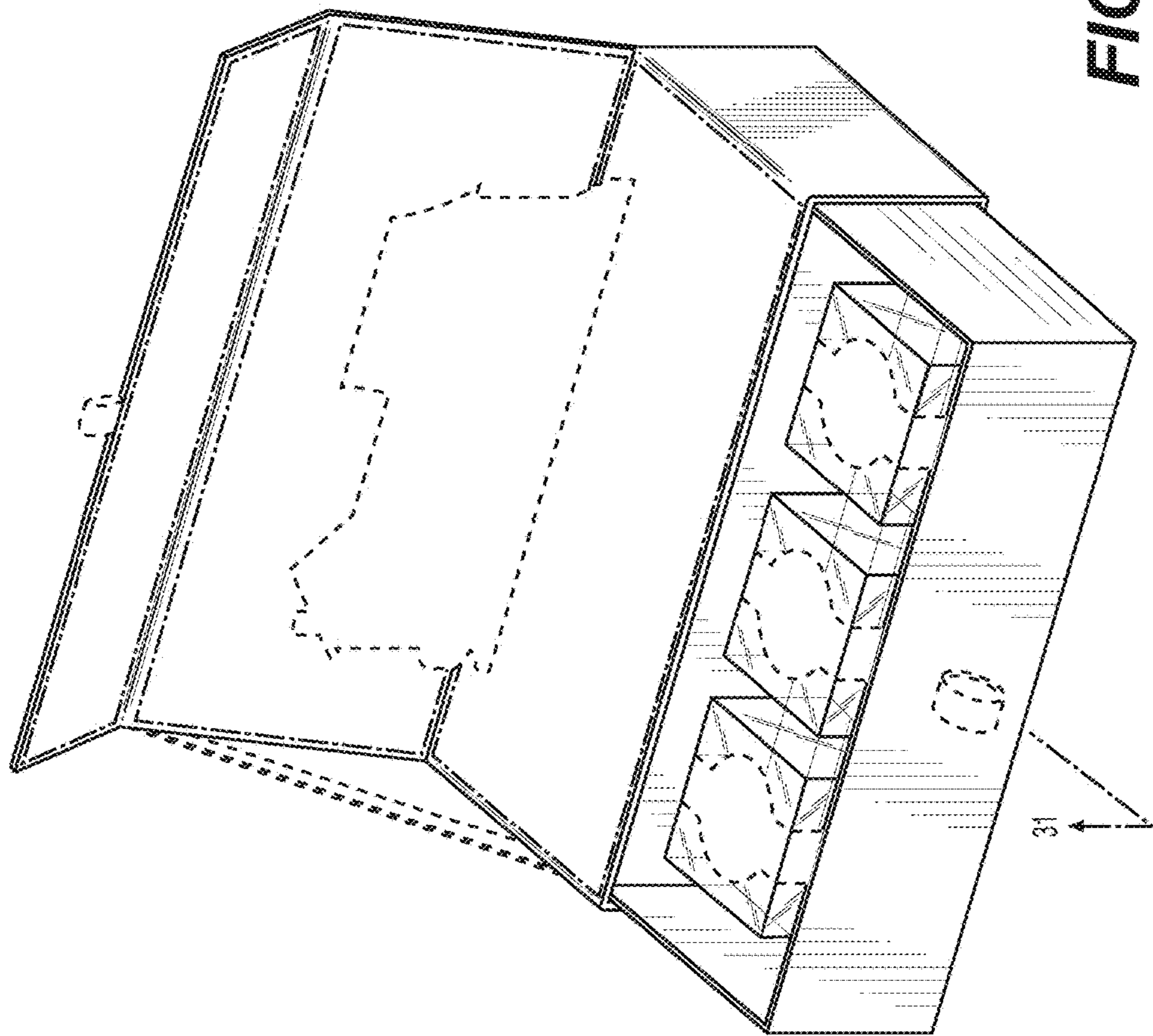

FIG. 15

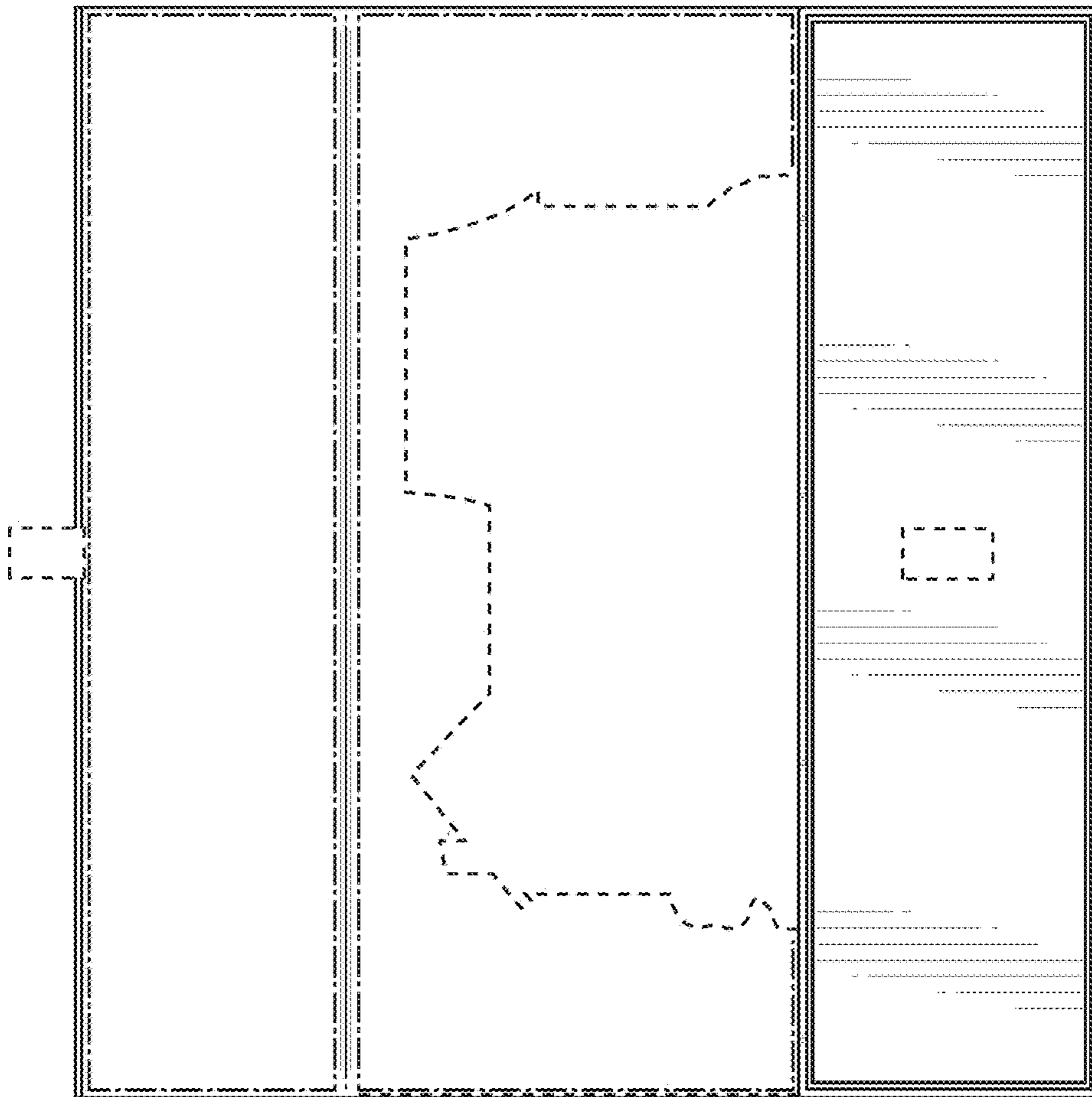

FIG. 16

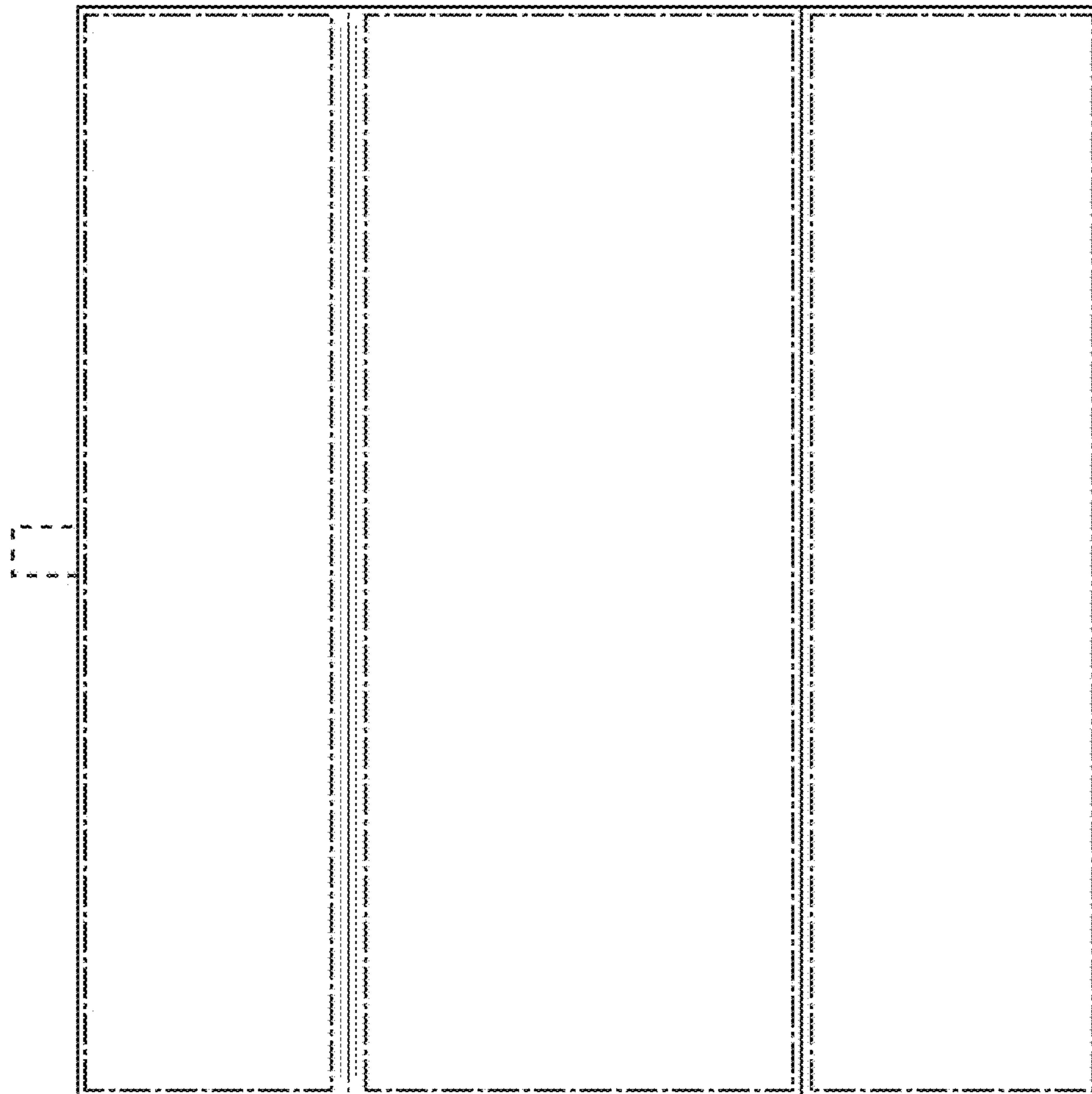

FIG. 17

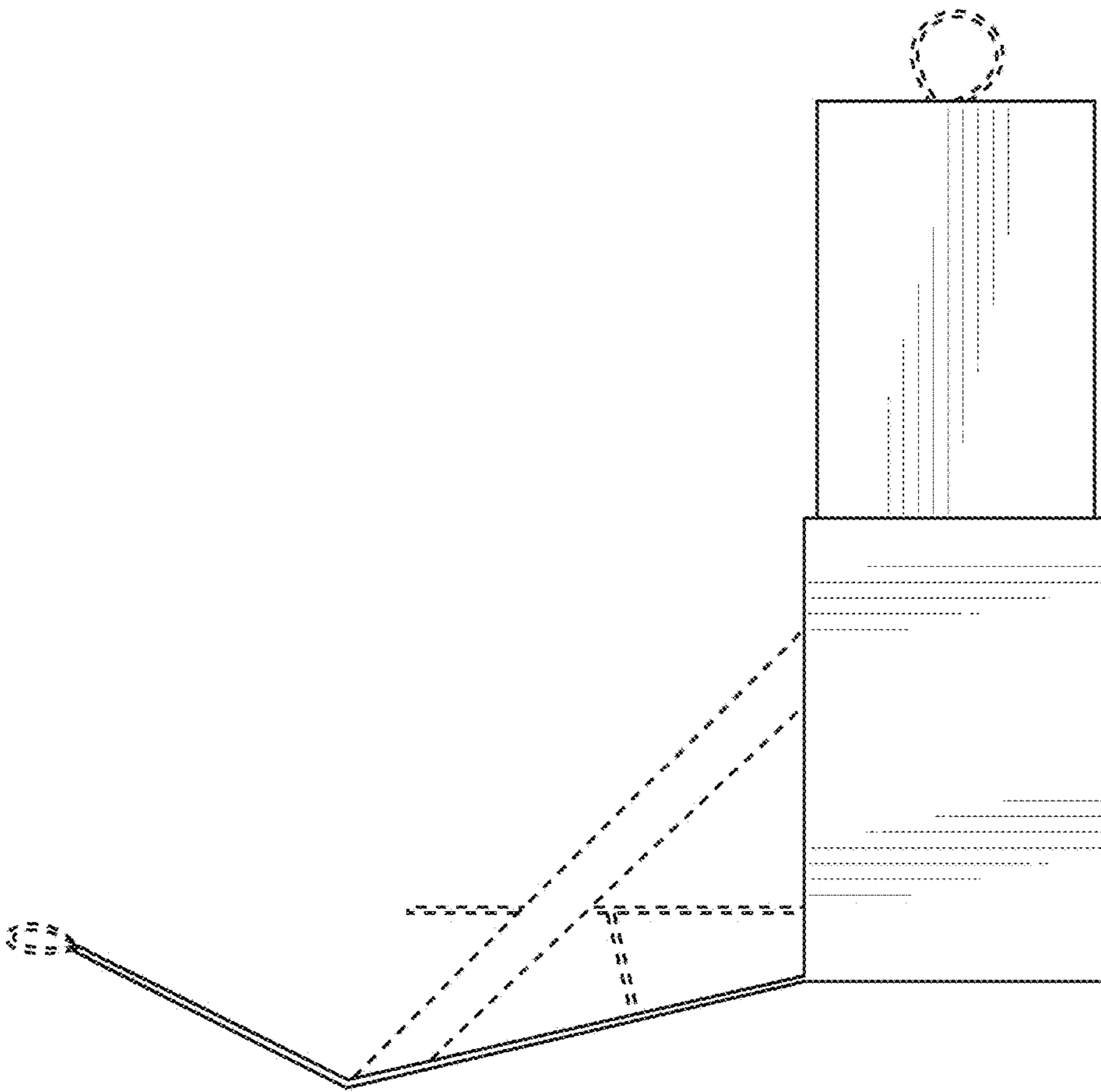

FIG. 18

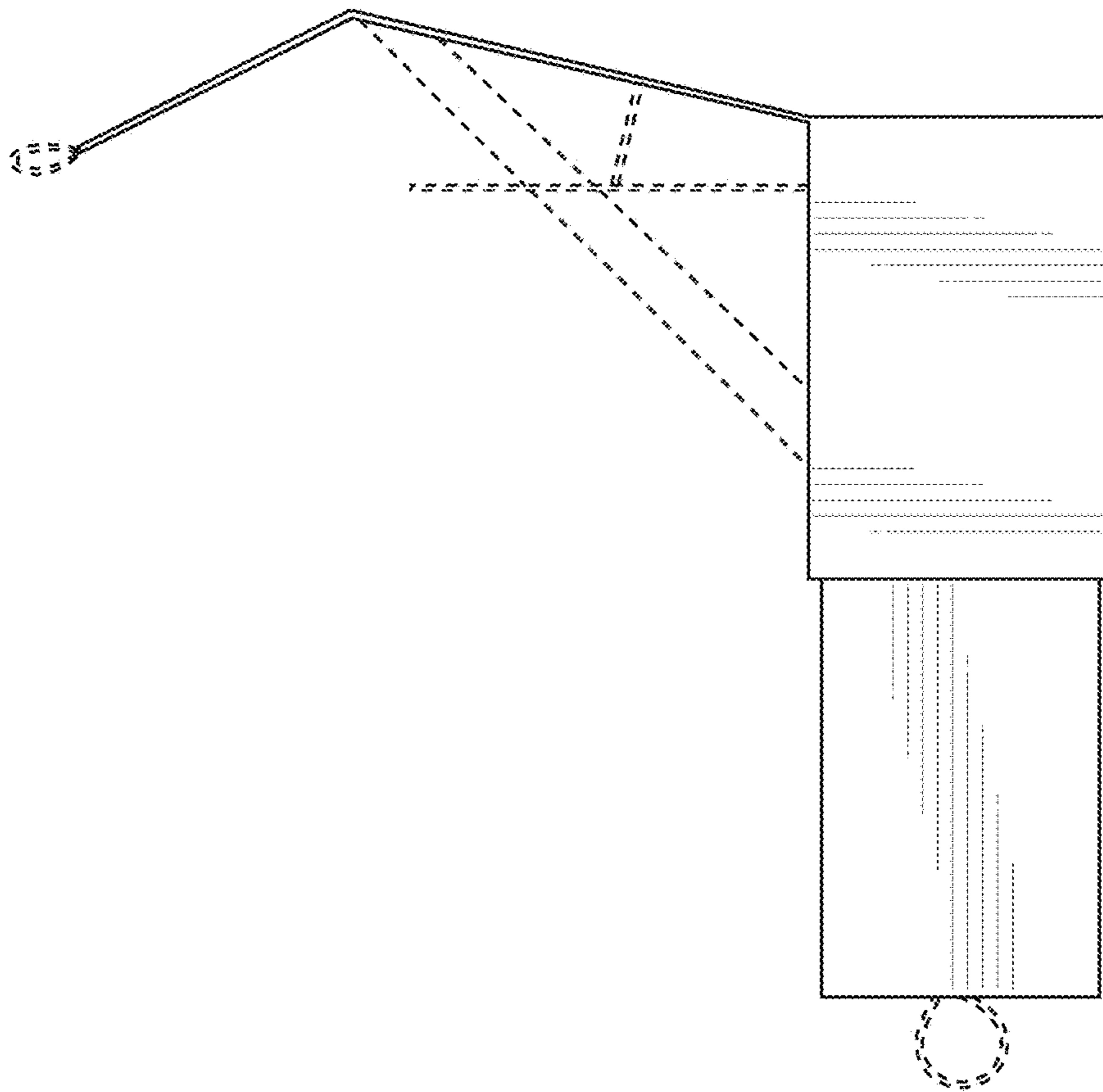

FIG. 19

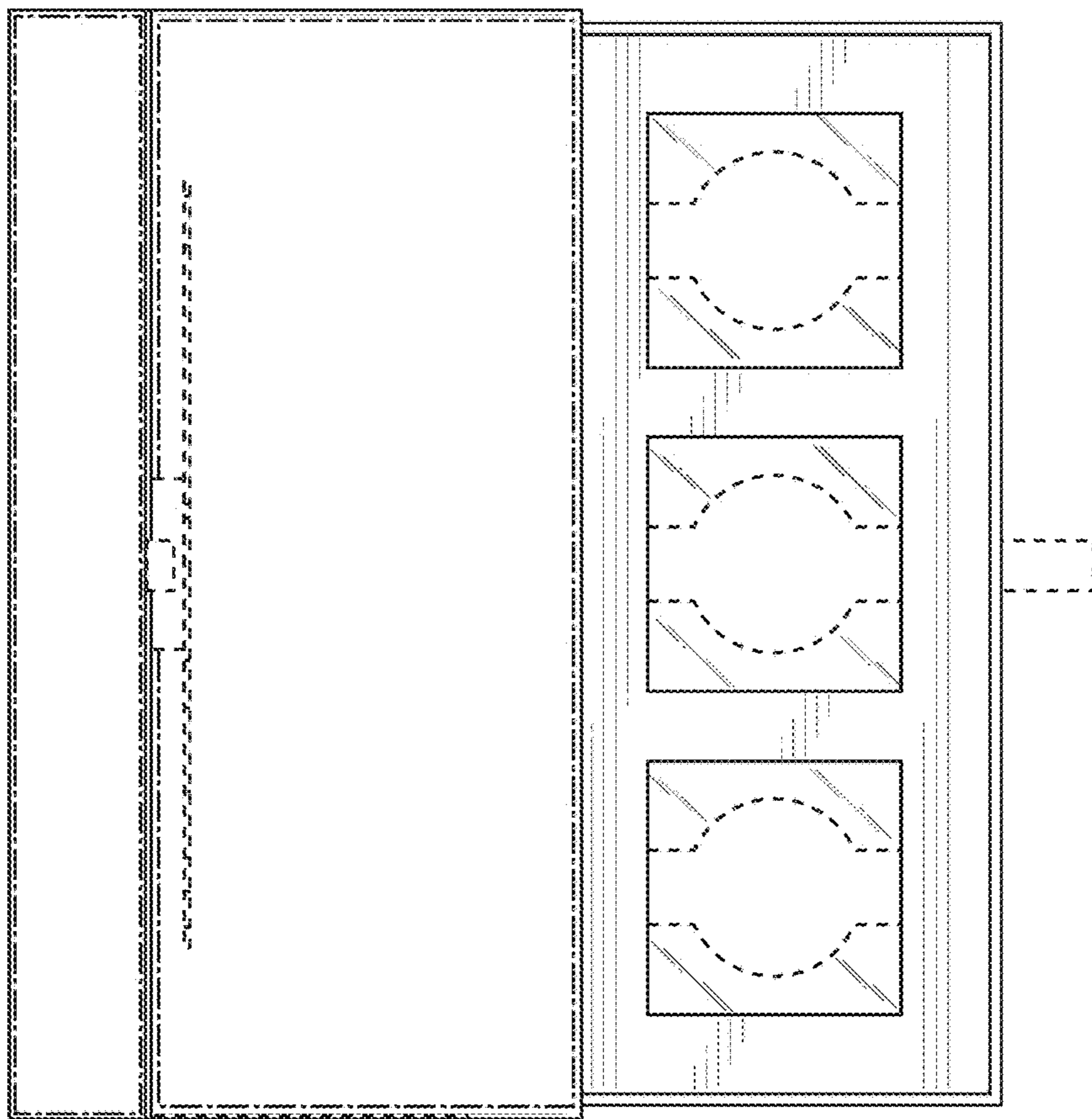

FIG. 20

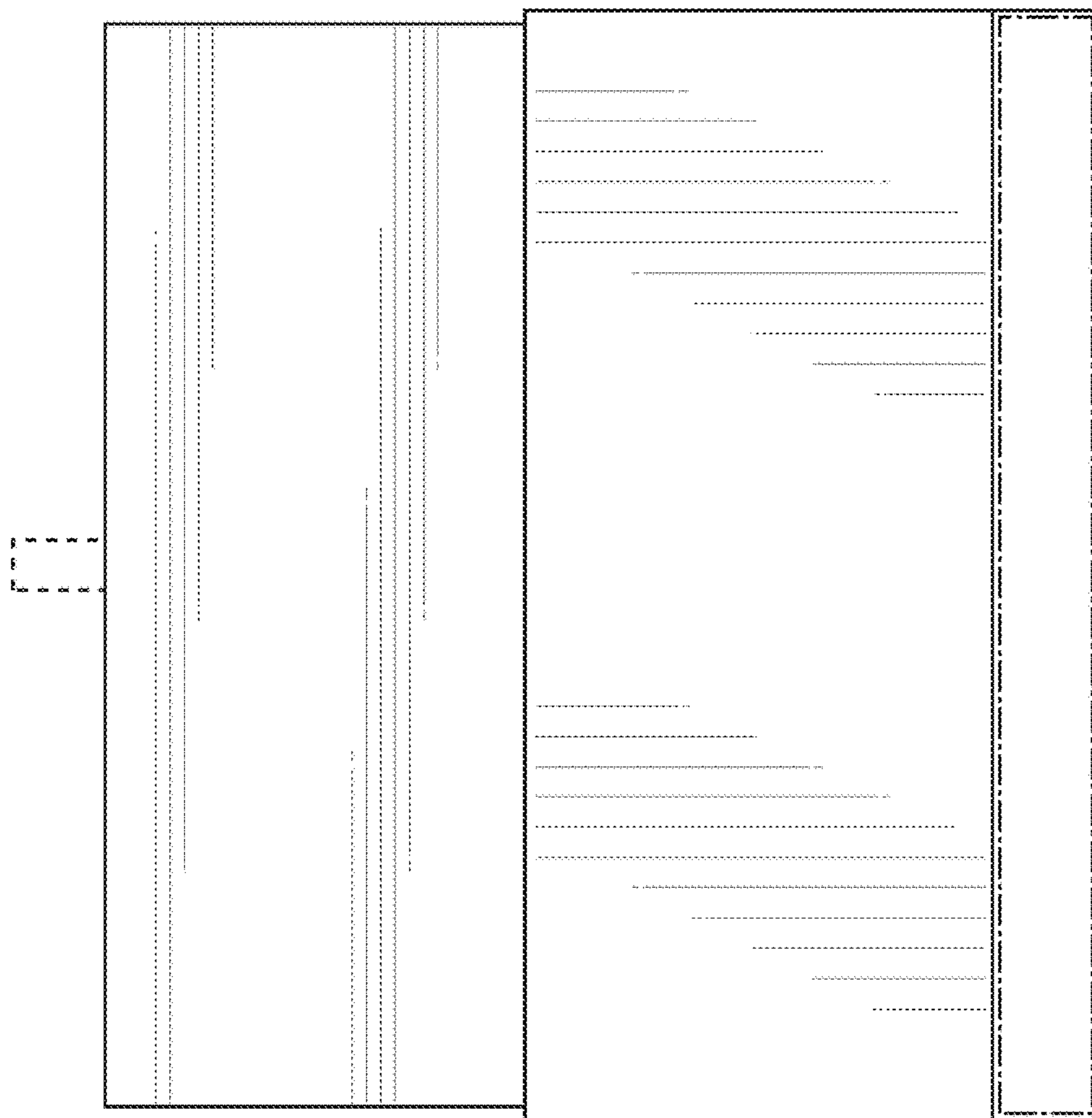

FIG. 21

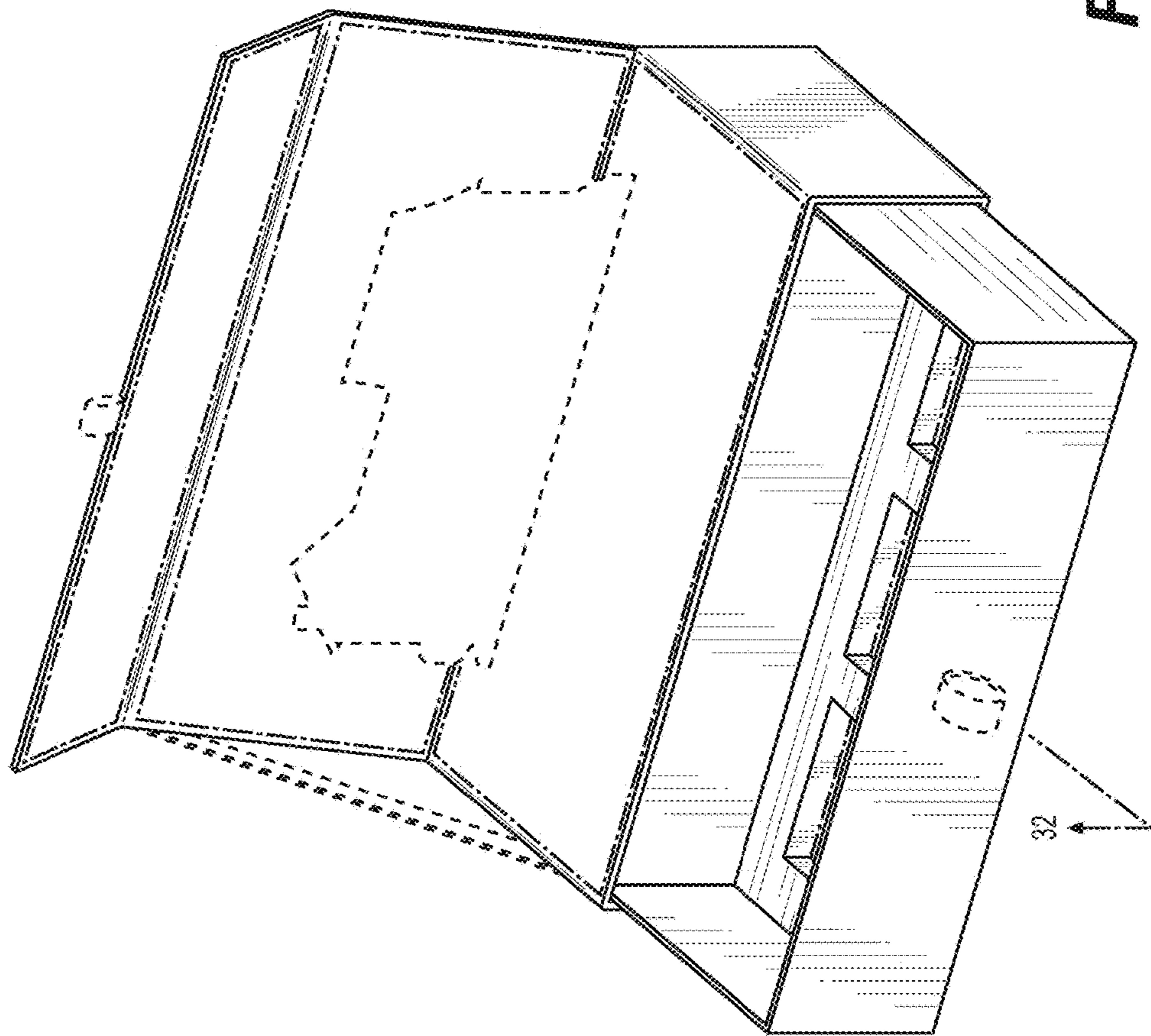

FIG. 22

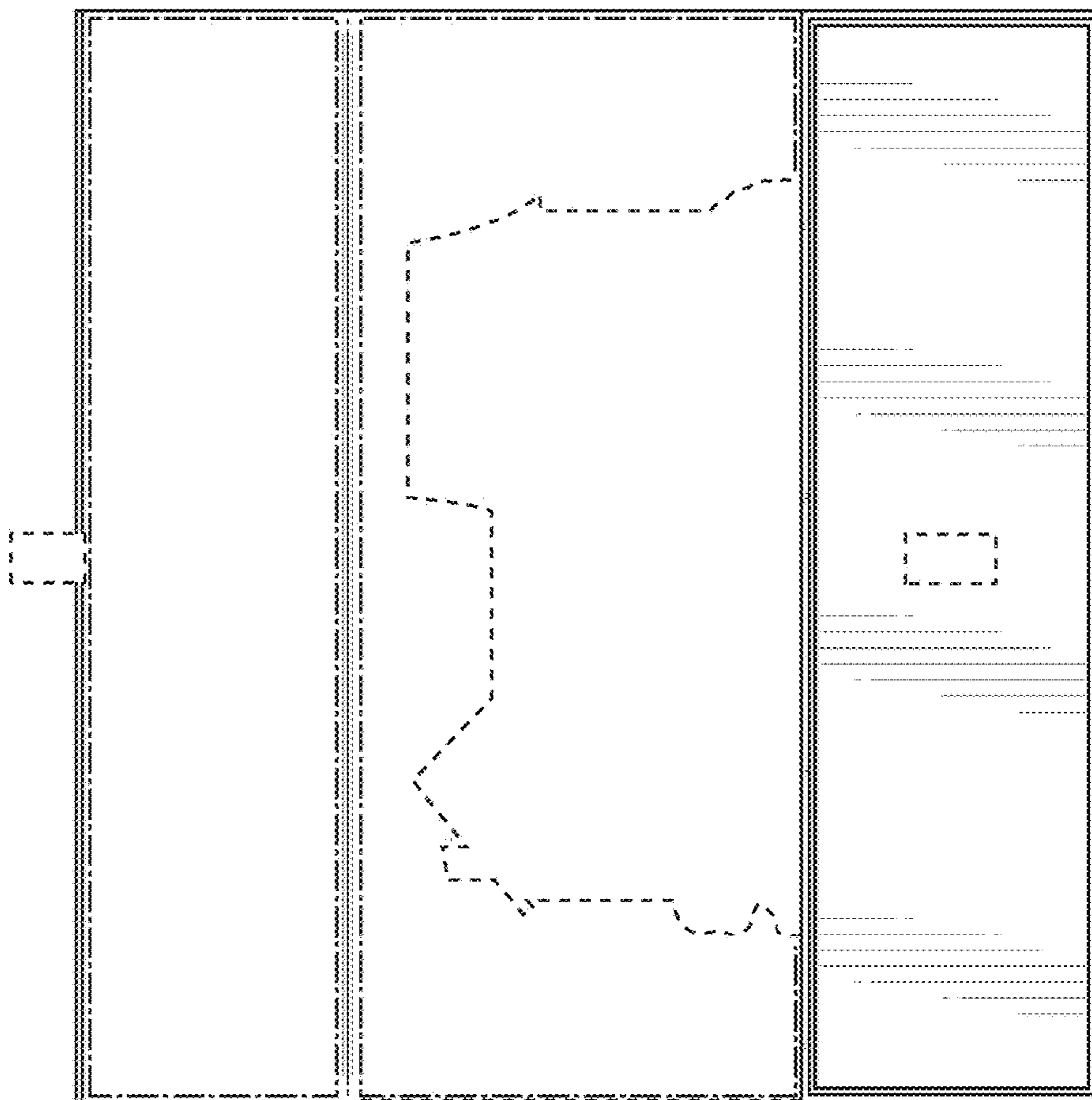

FIG. 23

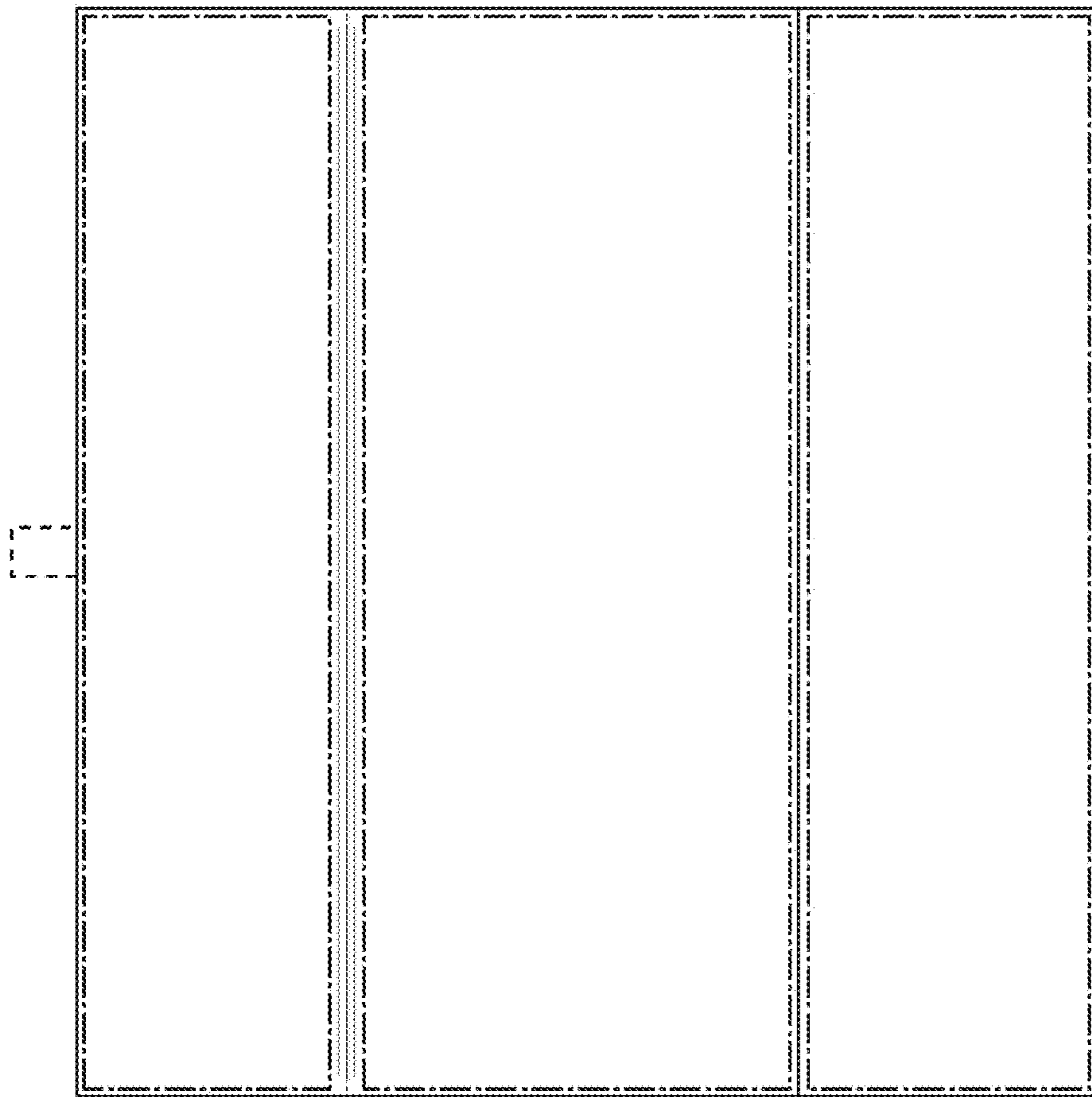

FIG. 24

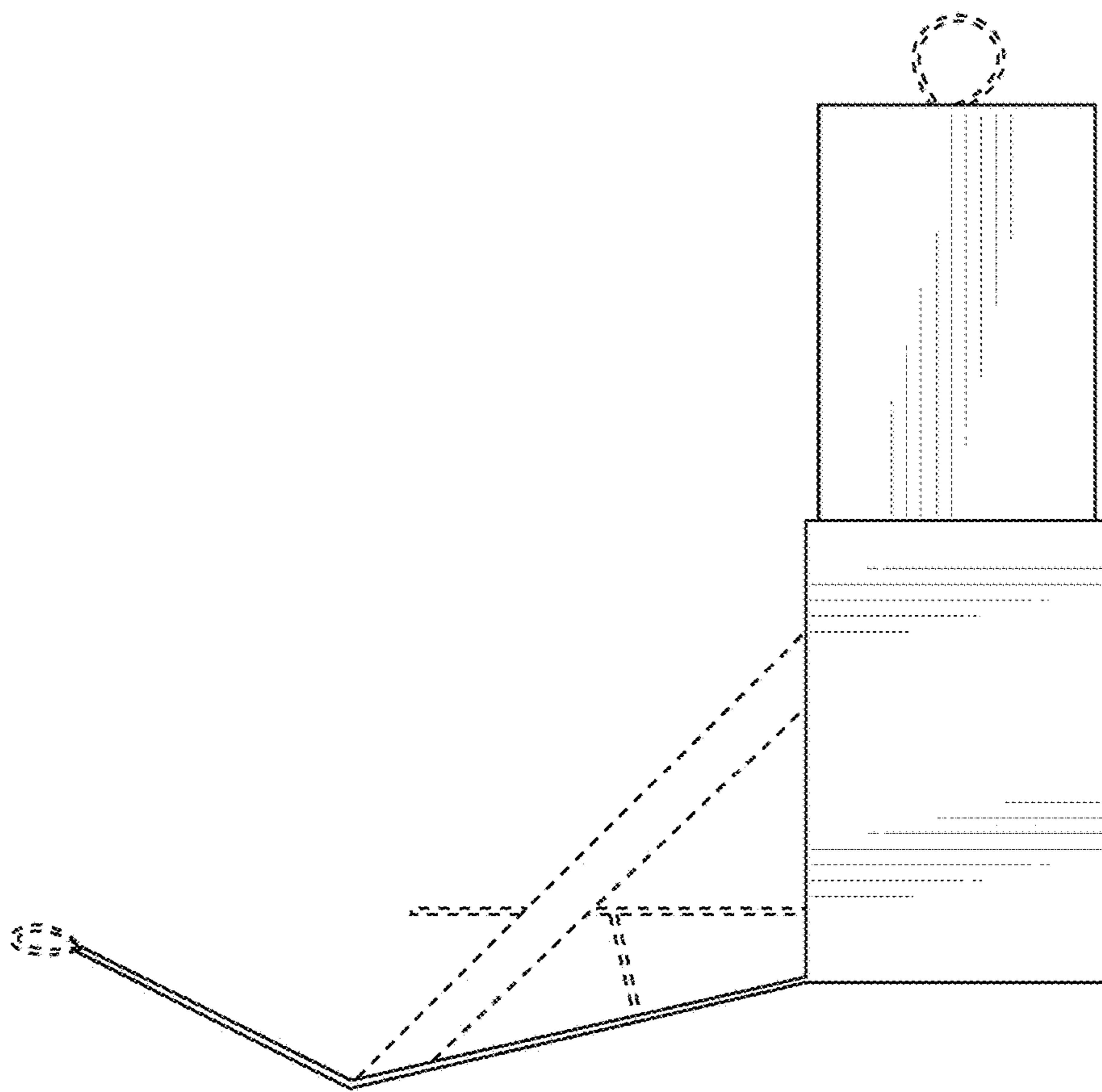

FIG. 25

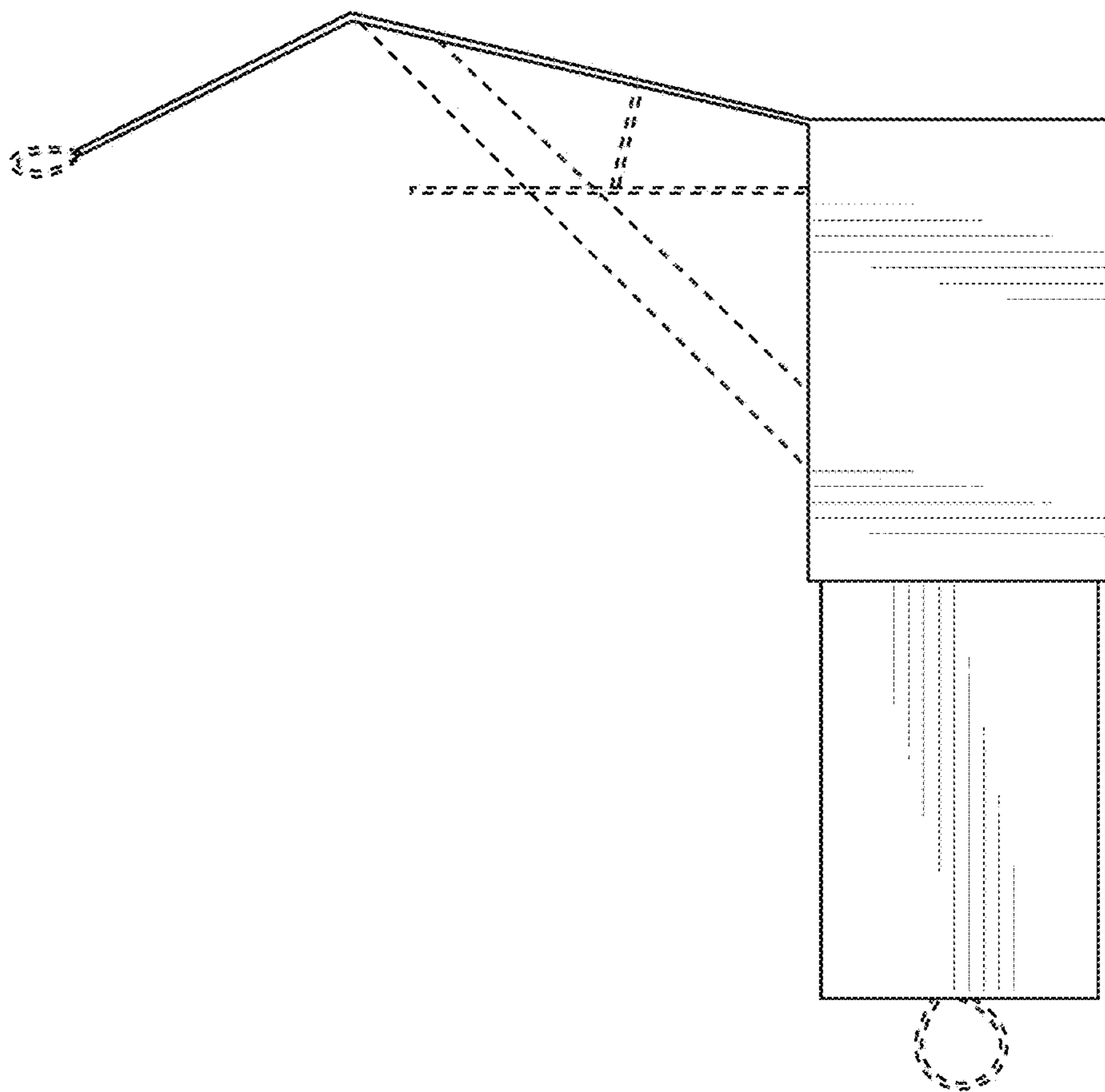

FIG. 26

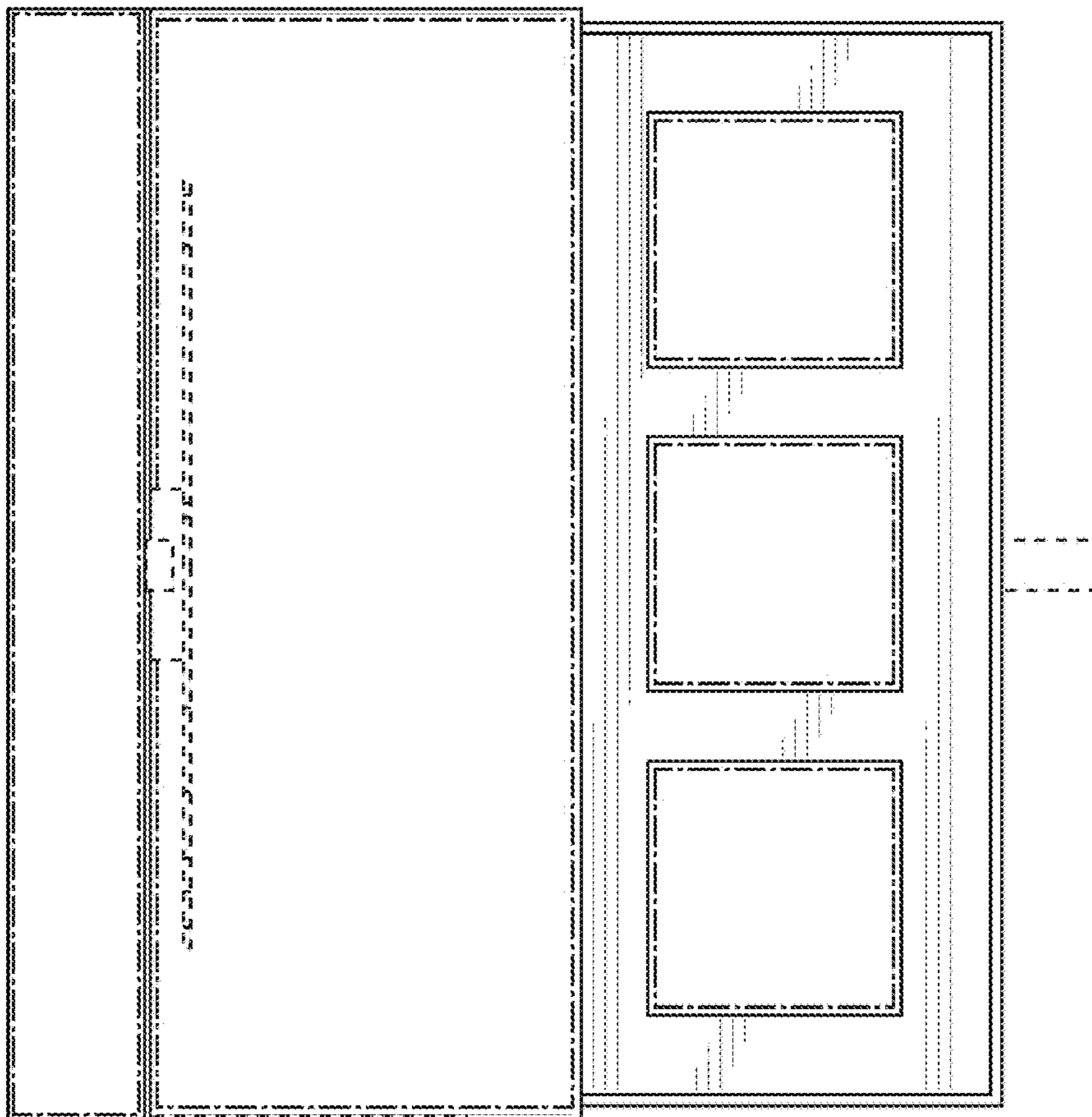

FIG. 27

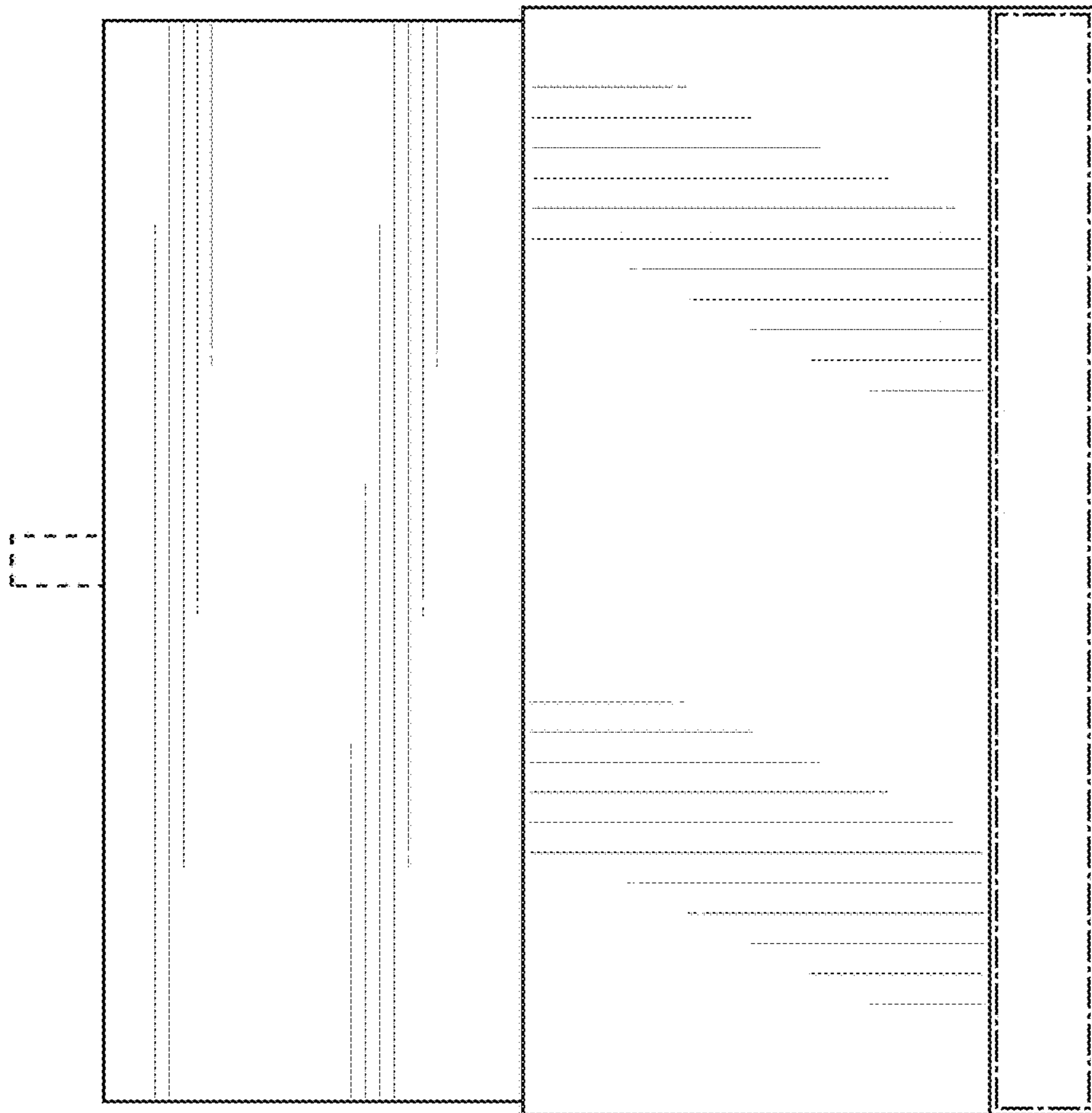

FIG. 28

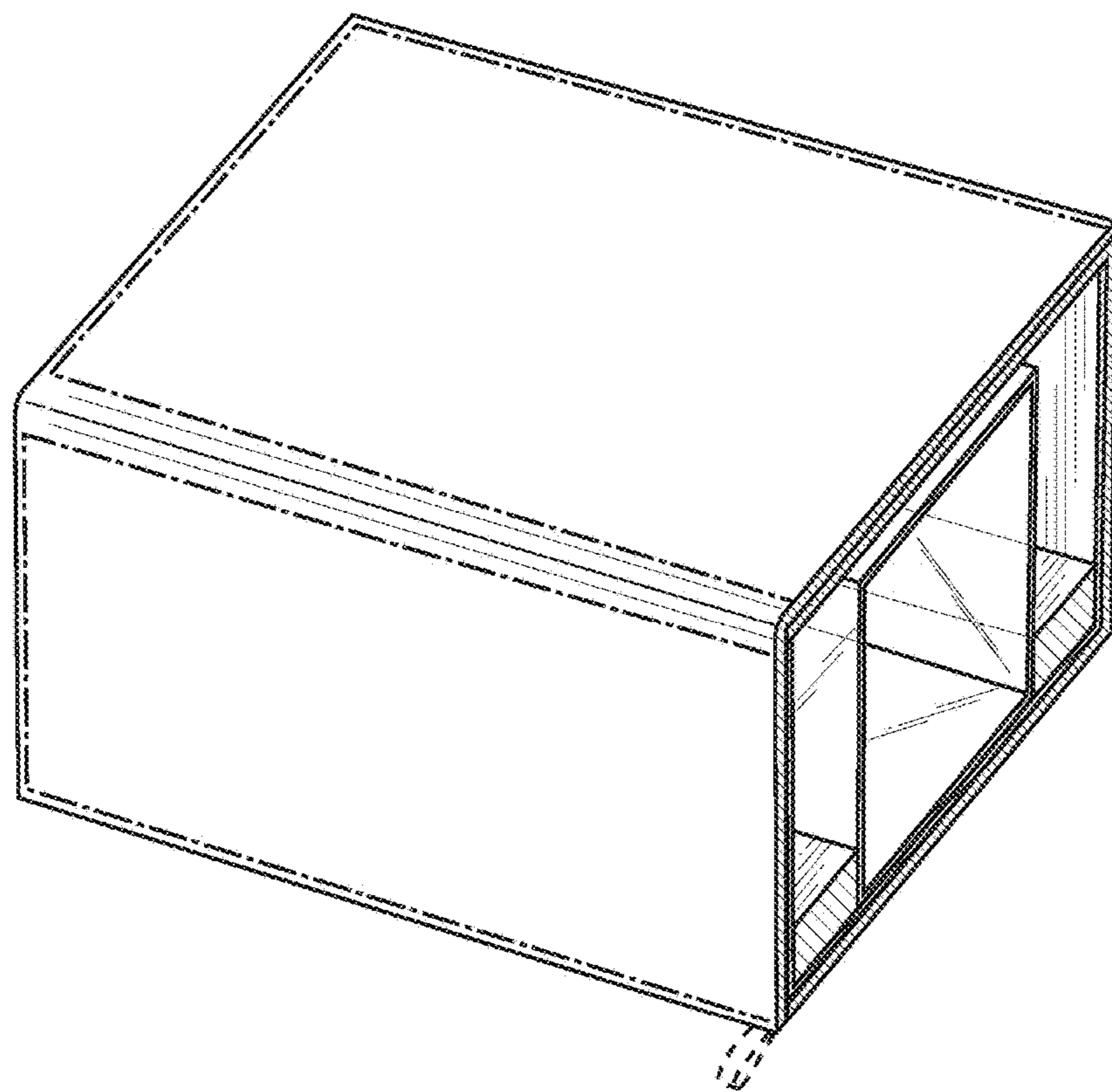

FIG. 29

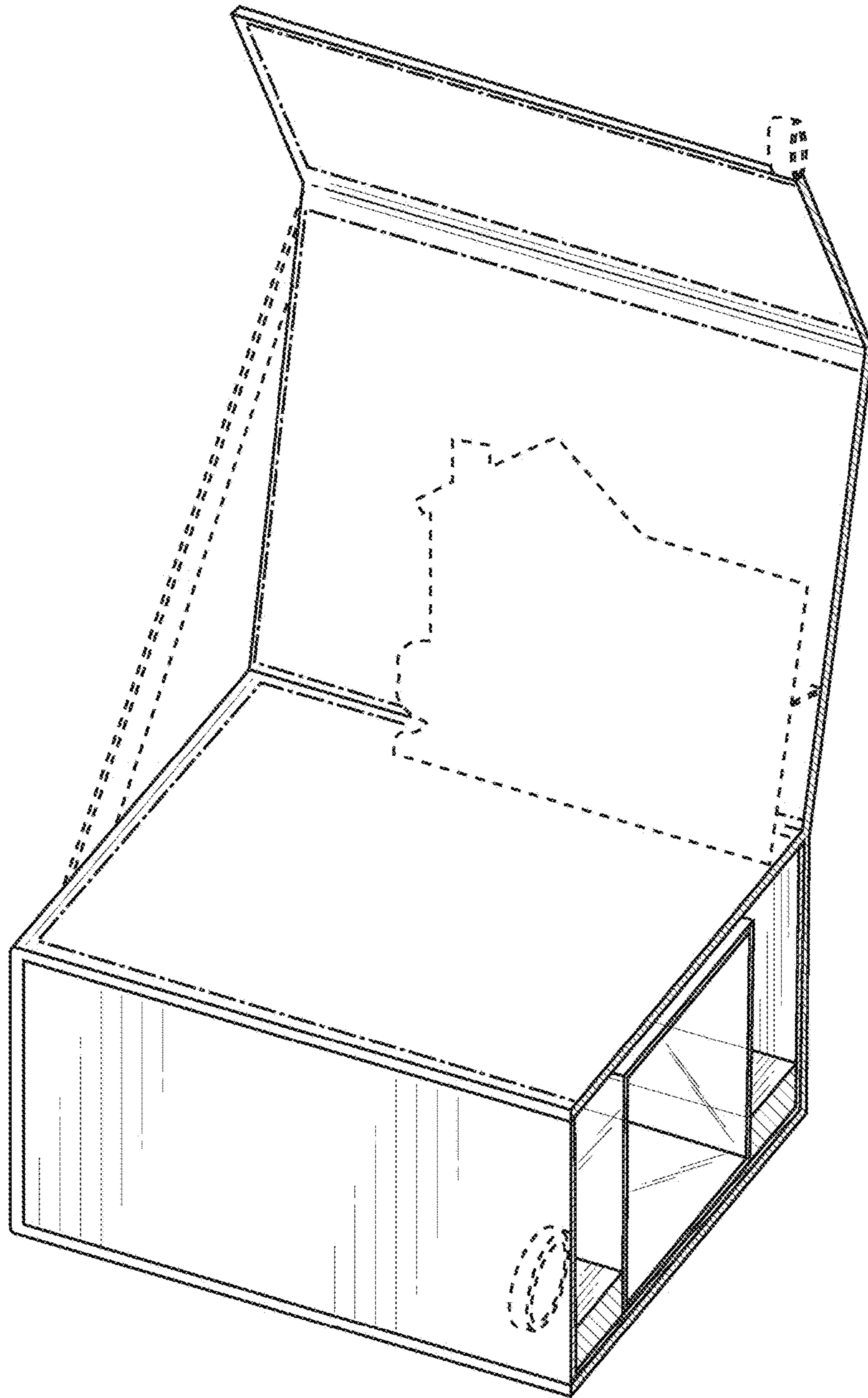

FIG. 30

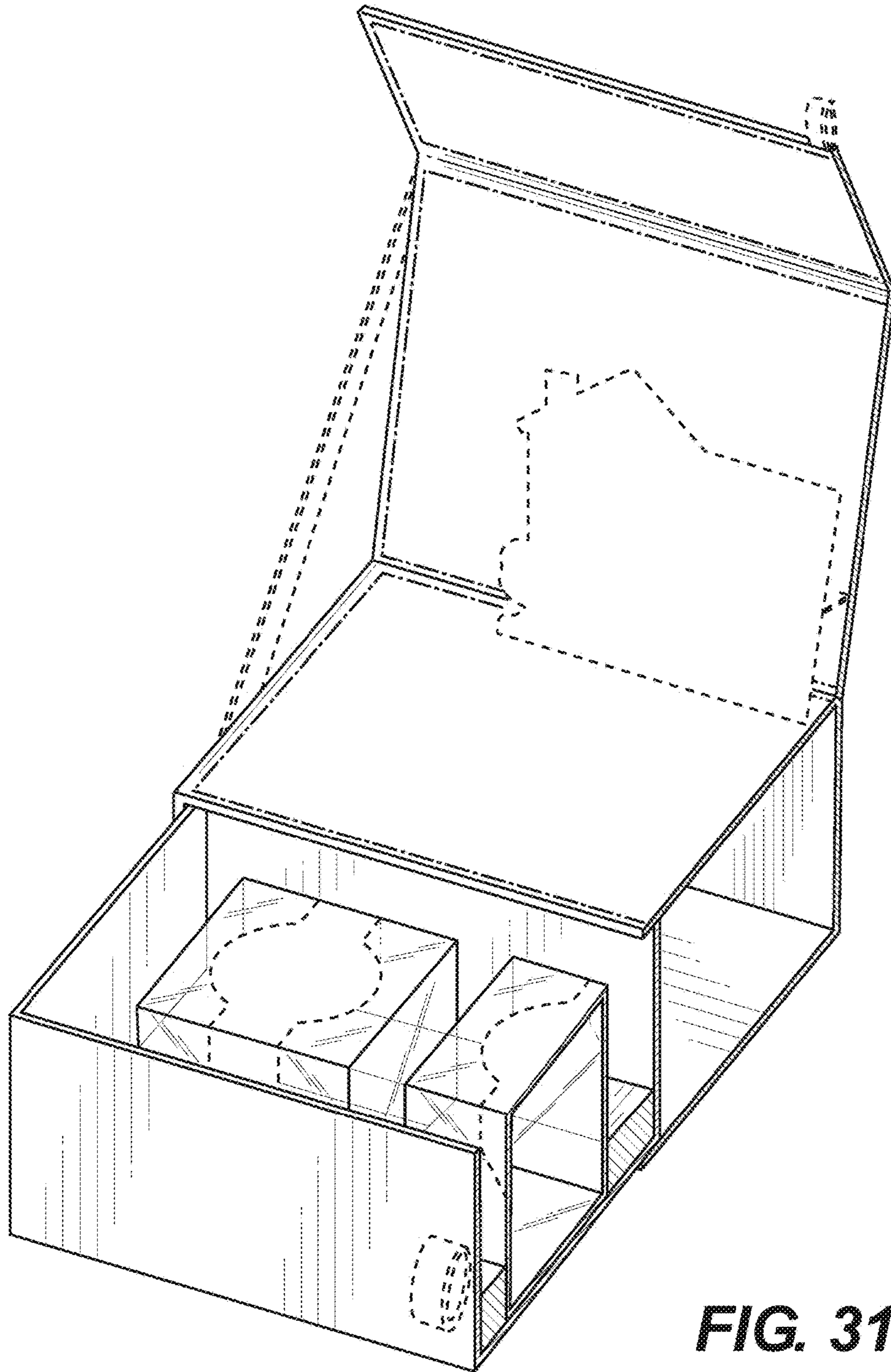

FIG. 31

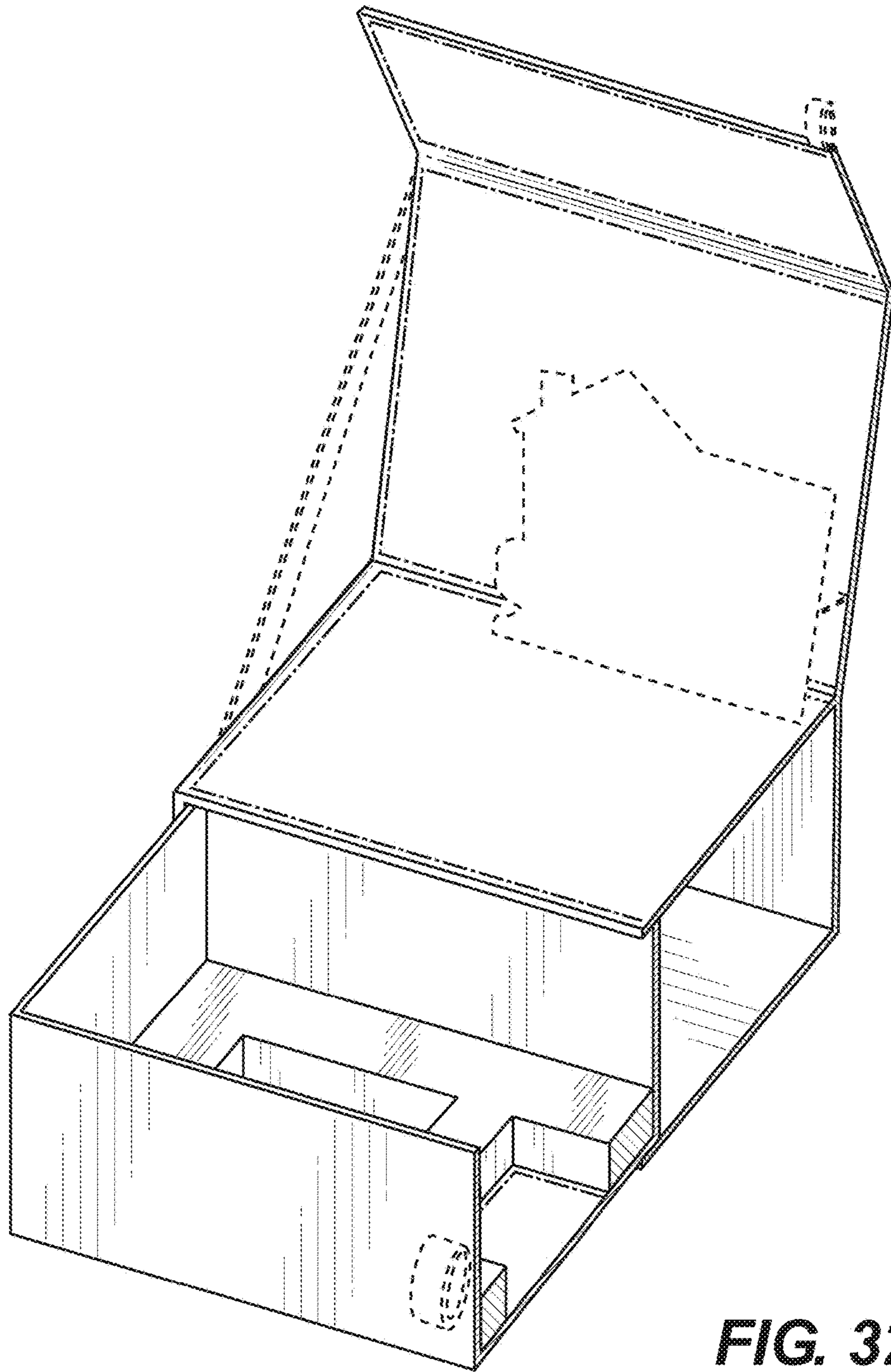

FIG. 32