



US00D829560S

(12) **United States Design Patent** (10) **Patent No.:** **US D829,560 S**
Arzano et al. (45) **Date of Patent:** **** *Oct. 2, 2018**

(54) **CONTAINER WITH LID AND LABEL**

(71) Applicant: **Conopco, Inc.**, Englewood Cliffs, NJ (US)

(72) Inventors: **Victoria Louise Arzano**, New York, NY (US); **Randi Lynn Silberman**, Brooklyn, NY (US)

(73) Assignee: **Conopco, Inc.**, Englewood Cliffs, NJ (US)

(*) Notice: This patent is subject to a terminal disclaimer.

(**) Term: **15 Years**

(21) Appl. No.: **29/593,360**

(22) Filed: **Feb. 8, 2017**

(30) **Foreign Application Priority Data**

Aug. 17, 2016 (EM) 003344217-0001

(51) **LOC (11) Cl.** **09-01**

(52) **U.S. Cl.**
USPC **D9/563; D9/575**

(58) **Field of Classification Search**

USPC D3/203.1; D20/22, 27, 37; D9/416, 454, D9/499, 516, 518, 560, 563, 570-575, D9/901; D24/121, 224; D4/114
CPC B65D 2501/0081; B65D 25/205; B65D 41/3447; B65D 23/14
See application file for complete search history.

(56) **References Cited**

U.S. PATENT DOCUMENTS

D185,514 S * 6/1959 Ryan D20/22
5,544,768 A * 8/1996 Gargione B65D 50/046
215/209
D382,488 S * 8/1997 Ja D9/560
5,803,287 A * 9/1998 Kusz B65D 41/0471
215/330
D399,756 S * 10/1998 Lonczak D9/574

D499,452 S * 12/2004 Walsh D20/22
D503,620 S * 4/2005 Taylor D9/518
D535,566 S * 1/2007 Lin D9/453
D548,607 S * 8/2007 Langbein D9/454
D590,721 S * 4/2009 Martinez De San Vicente
D9/520
D602,785 S * 10/2009 Rothberg D9/547
D691,054 S * 10/2013 Olsson D9/435

(Continued)

OTHER PUBLICATIONS

Co-pending application, Arzano et al., U.S. Appl. No. 29/593,344, filed Feb. 8, 2017, Transparent Container With Lid and Label.

(Continued)

Primary Examiner — Ian Simmons

Assistant Examiner — Keith Frank

(74) *Attorney, Agent, or Firm* — Foley & Lardner LLP

(57) **CLAIM**

An ornamental design for a container with lid and label, as shown and described.

DESCRIPTION

The patent or application file contains at least one drawing executed in color. Copies of this patent or patent application publication with color drawing(s) will be provided by the Office upon request and payment of the necessary fee.

FIG. 1 is a front and side perspective view of a container with lid and label showing our new design;

FIG. 2 is a front elevation view thereof;

FIG. 3 is a rear elevation view thereof;

FIG. 4 is a left side elevation view thereof;

FIG. 5 is a right side elevation view thereof; and,

FIG. 6 is a top plan view thereof.

The use of the color in the accompanying drawings is to be considered an integral part of the disclosed and claimed design.

1 Claim, 6 Drawing Sheets
(6 of 6 Drawing Sheet(s) Filed in Color)

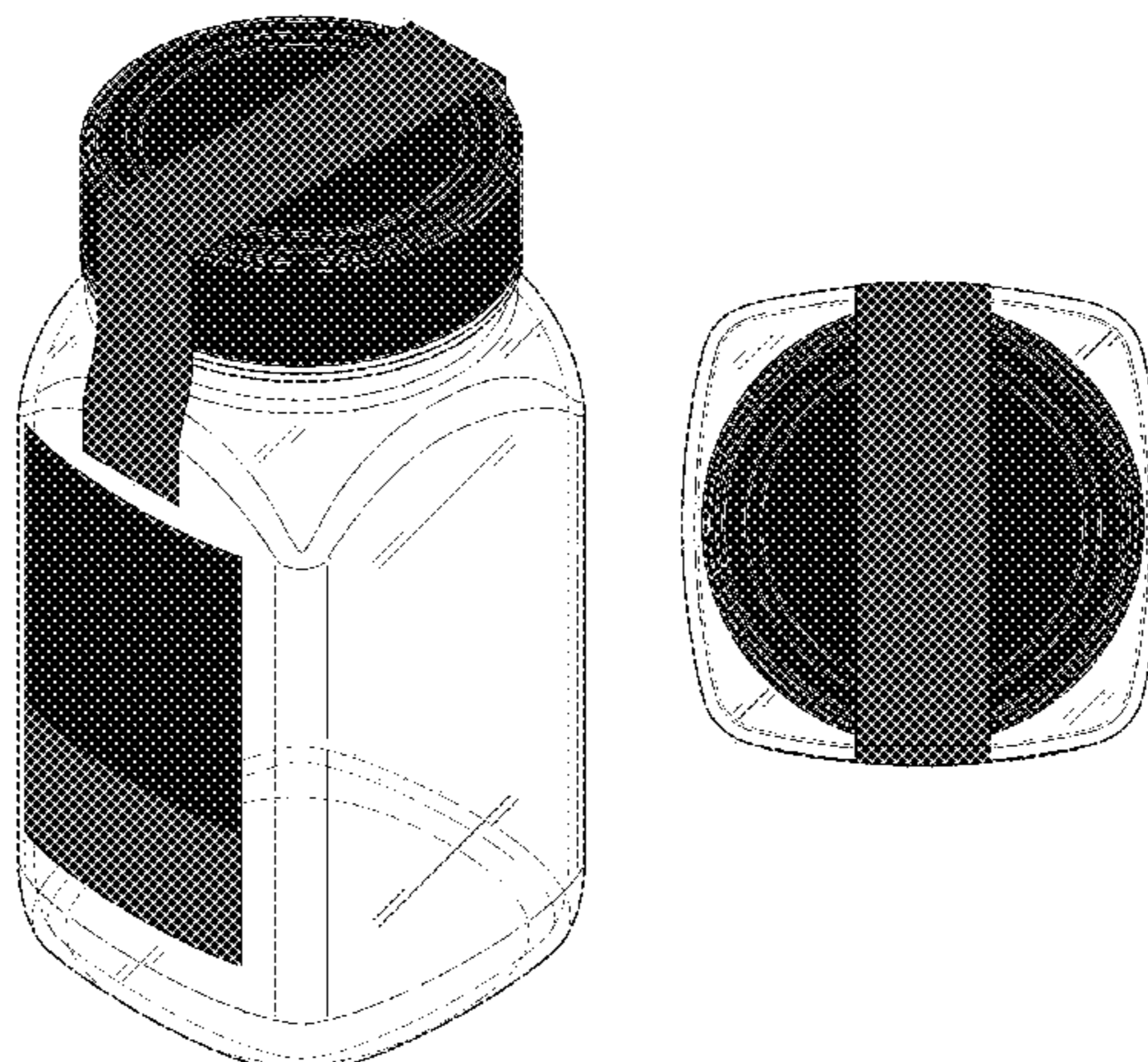

(56)

References Cited

U.S. PATENT DOCUMENTS

D707,297 S * 6/2014 Hoang D20/27
 D717,661 S * 11/2014 McIntire D9/560
 D756,234 S * 5/2016 Orset D9/560
 D775,726 S * 1/2017 Giancursio, II D24/121
 D781,378 S * 3/2017 Miceli D20/22
 D798,160 S * 9/2017 Miller D9/560
 2004/0007556 A1* 1/2004 Manera B65D 41/06
 215/332
 2011/0198838 A1* 8/2011 Sellars G09F 3/0288
 283/81
 2013/0126551 A1* 5/2013 Unger B01L 3/523
 222/1
 2013/0298435 A1* 11/2013 Silvano G09F 3/0289
 40/638
 2014/0068982 A1* 3/2014 Silvano G09F 3/0288
 40/638
 2016/0207045 A1* 7/2016 Unger B01L 3/523

OTHER PUBLICATIONS

Co-pending application, Arzano et al., U.S. Appl. No. 29/593,349, filed Feb. 8, 2017, Transparent Container With Lid and Coloured Label.

Co-pending application, Arzano et al., U.S. Appl. No. 29/593,353, filed Feb. 8, 2017, Transparent Container With Lid and Coloured Label.

Co-pending application, Arzano et al., U.S. Appl. No. 29/593,354, filed Feb. 8, 2017, Transparent Container With Lid and Coloured Label.

Co-pending application, Arzano et al., U.S. Appl. No. 29/593,356, filed Feb. 8, 2017, Transparent Container With Lid and Coloured Label.

Co-pending application, Arzano et al., U.S. Appl. No. 29/593,361, filed Feb. 8, 2017, Transparent Container With Lid and Coloured Label.

Co-pending application, Arzano et al., U.S. Appl. No. 29/593,362, filed Feb. 8, 2017, Transparent Container With Lid and Coloured Label.

Co-pending application, Arzano et al., U.S. Appl. No. 29/593,364, filed Feb. 8, 2017, Transparent Container With Lid and Coloured Label.

Co-pending application, Arzano et al., U.S. Appl. No. 29/593,367, filed Feb. 8, 2017, Transparent Container With Lid and Coloured Label.

* cited by examiner

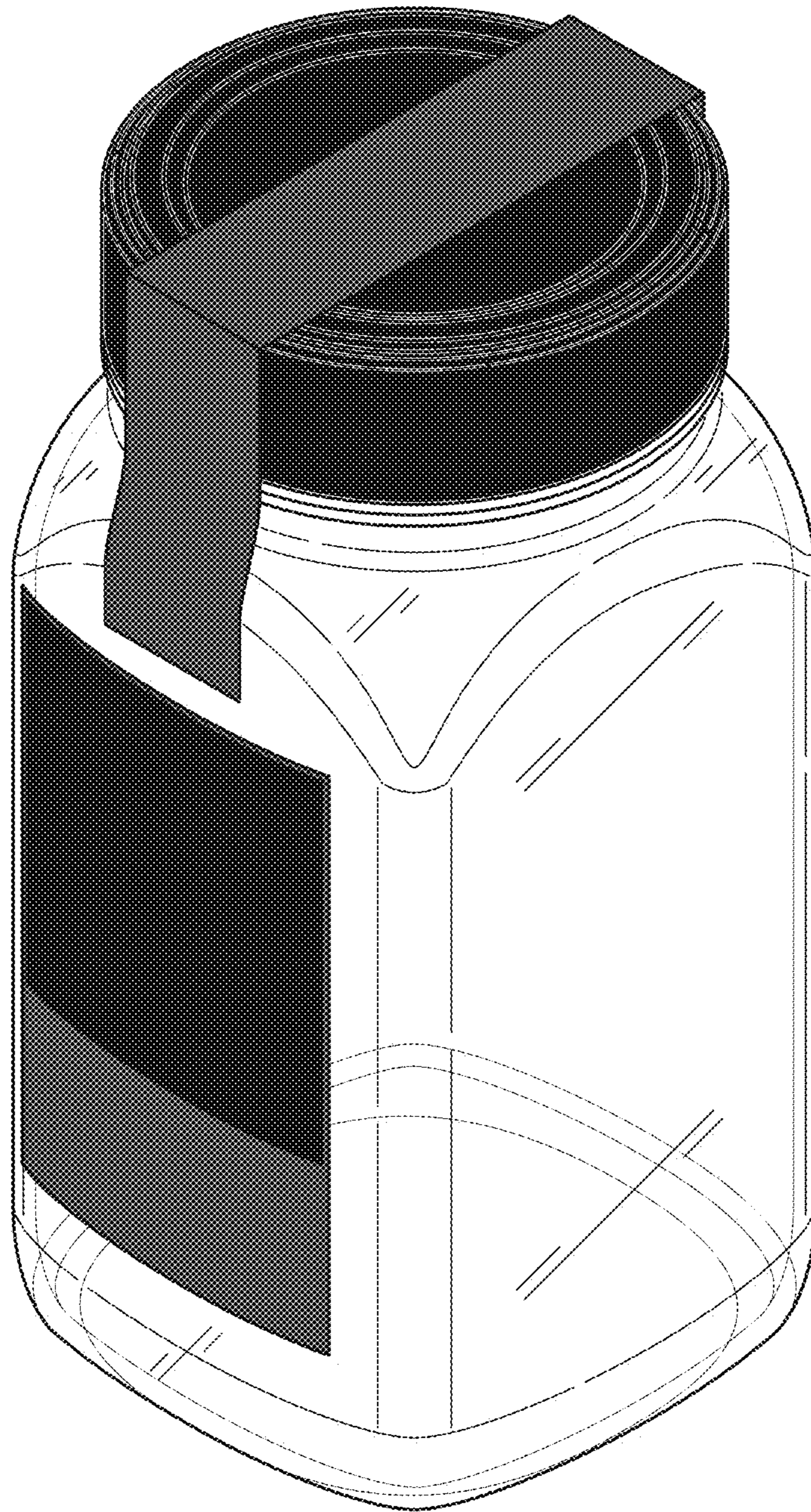

FIG. 1

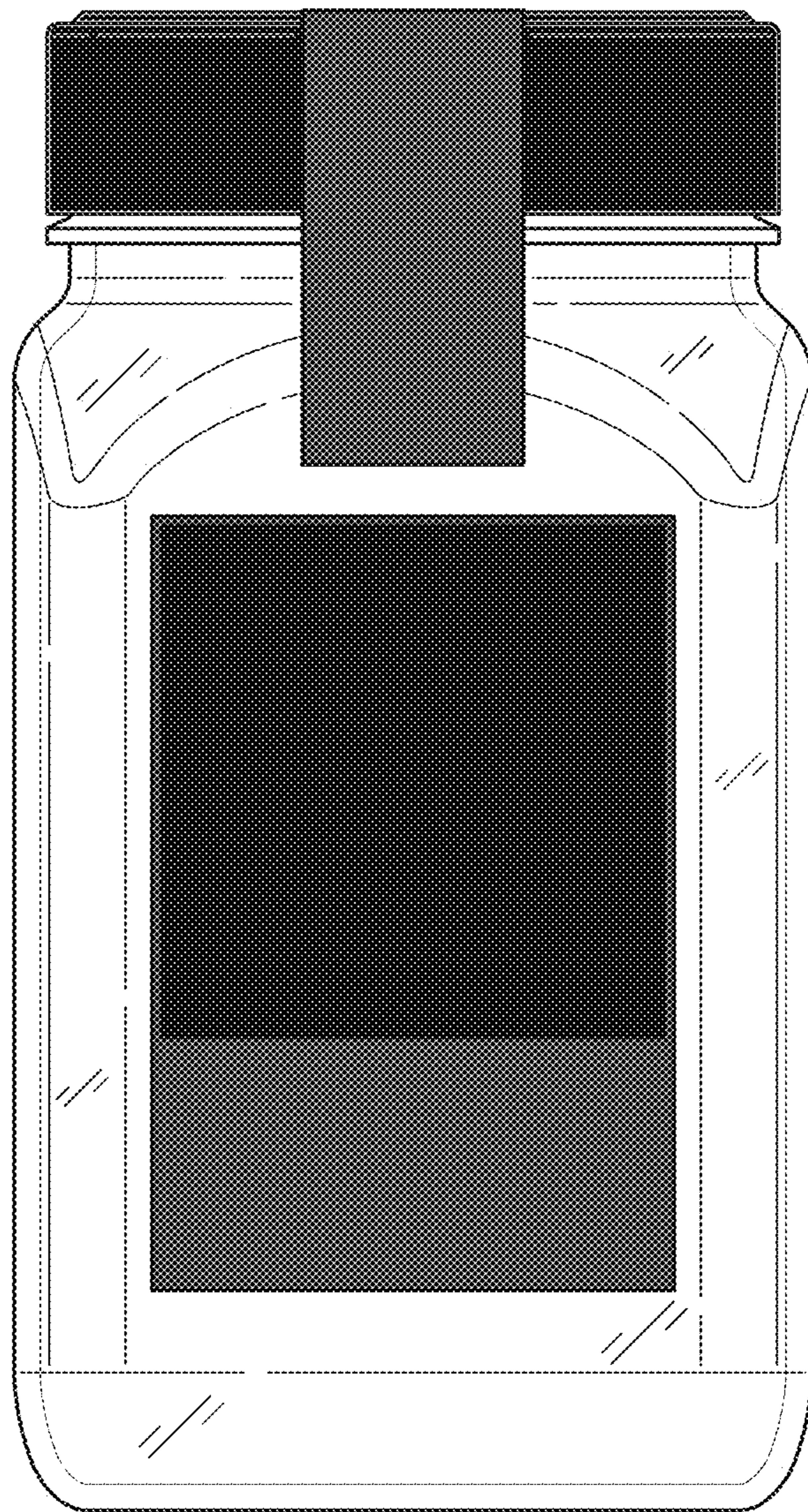

FIG. 2

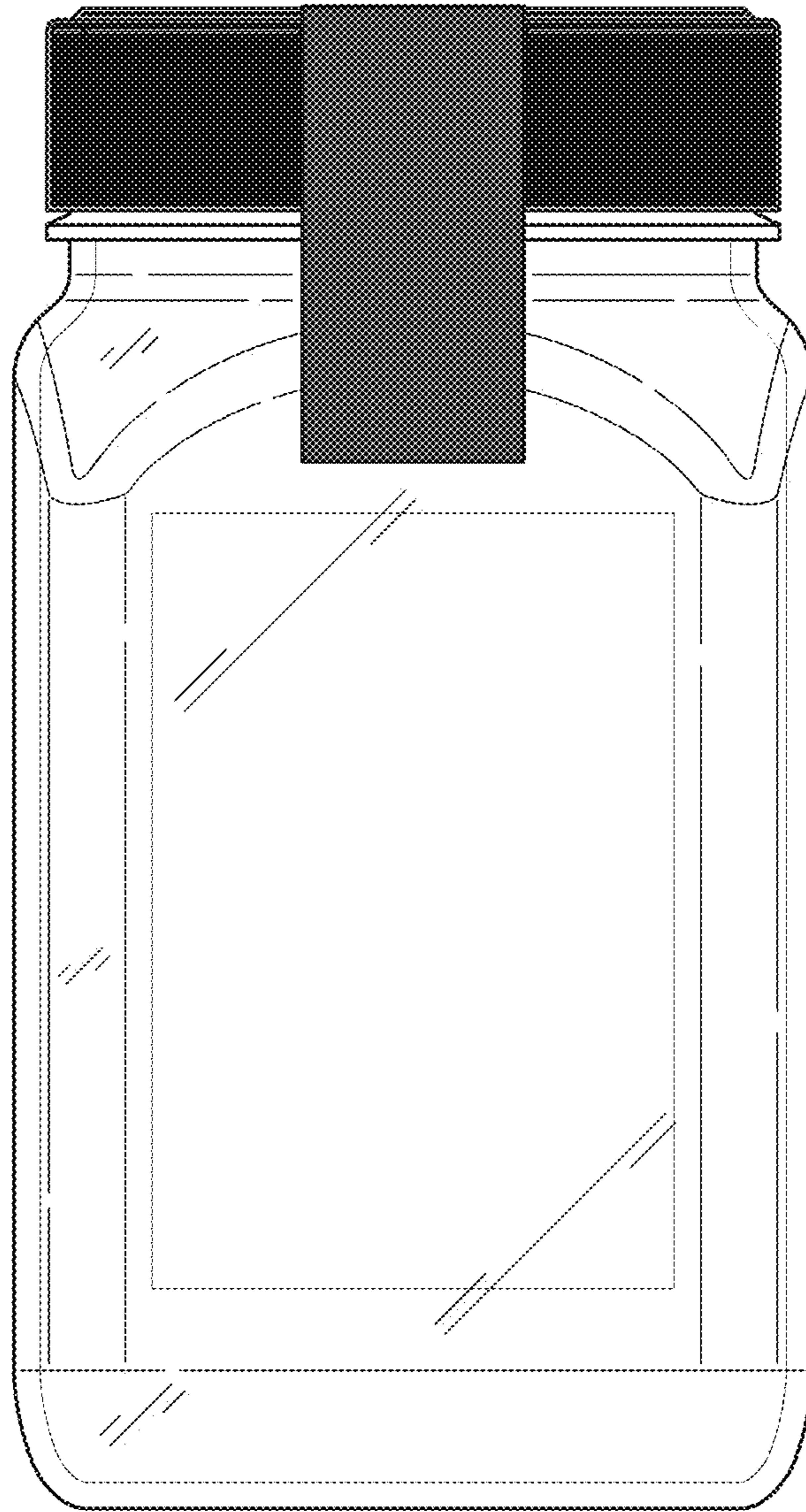

FIG. 3

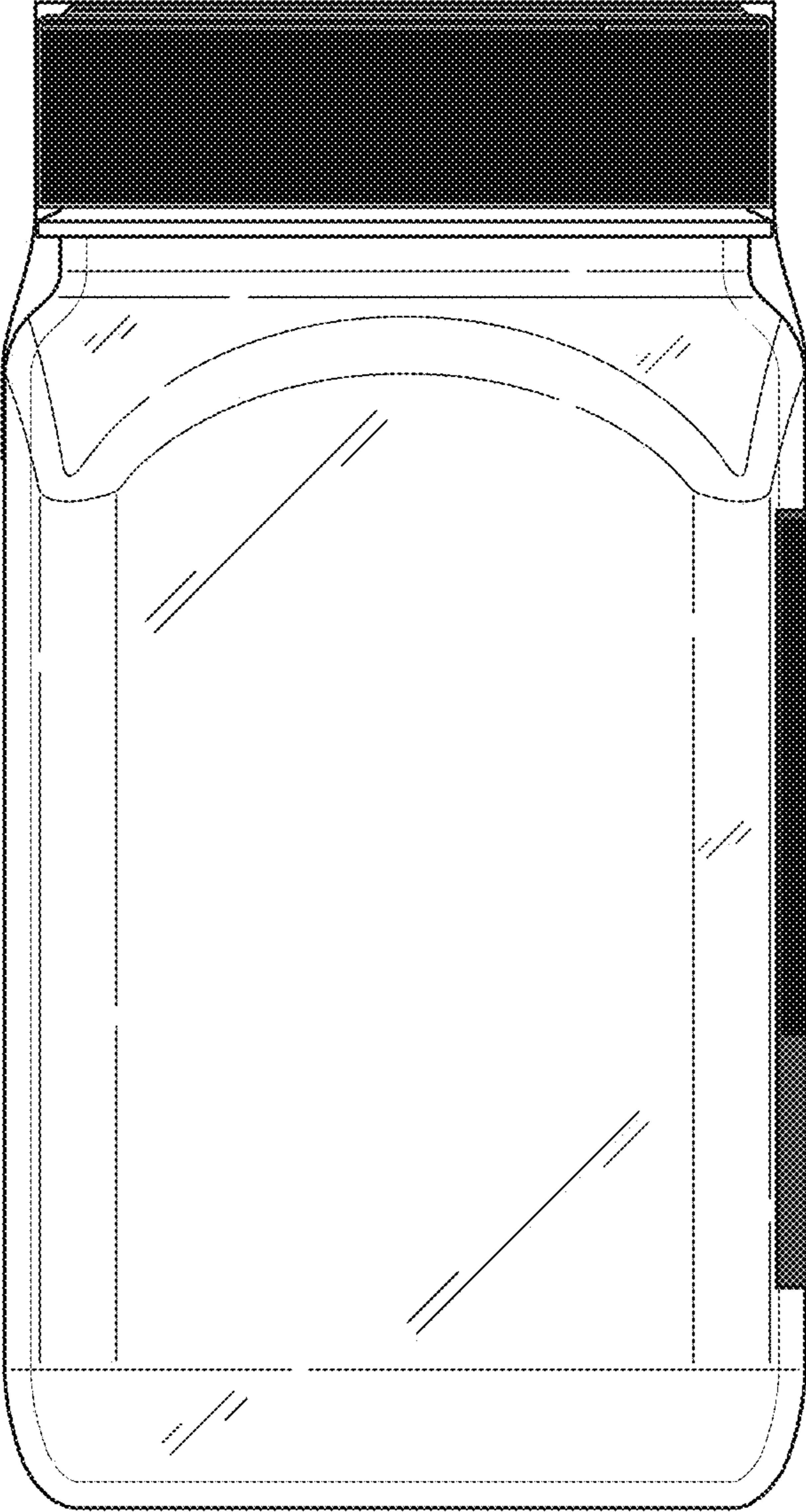

FIG. 4

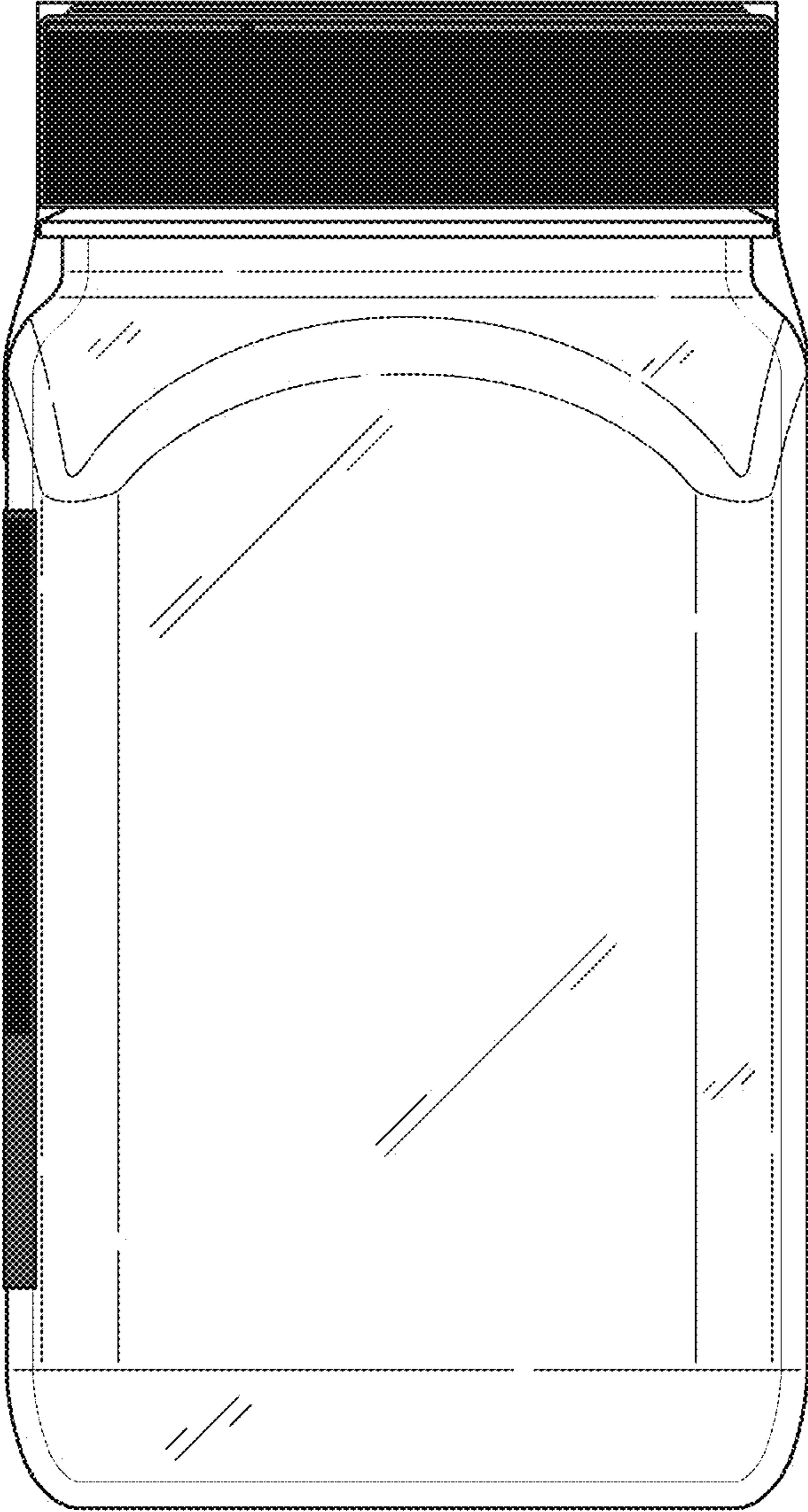

FIG. 5

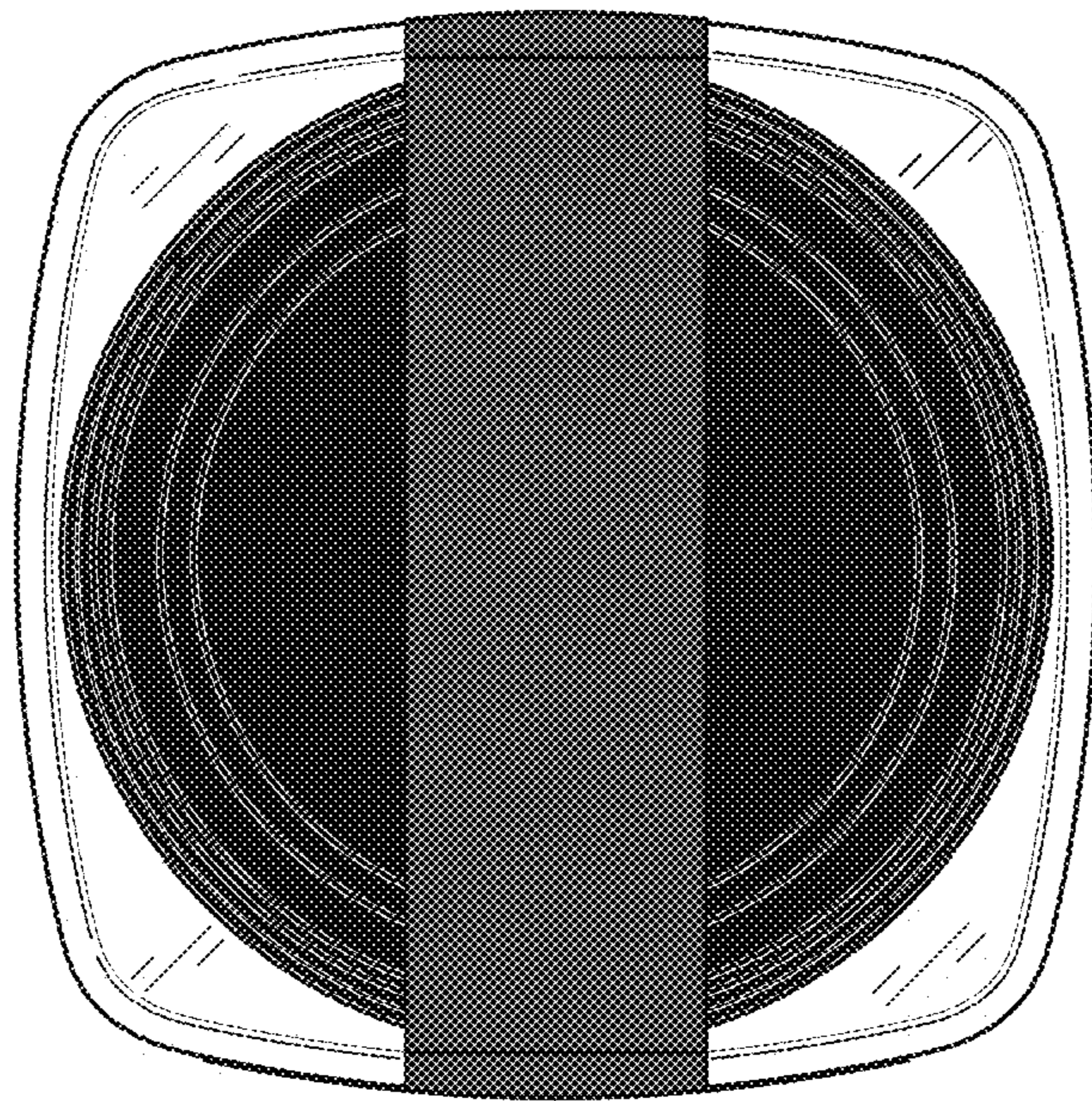

FIG. 6