



US00D829506S

(12) **United States Design Patent**  
**Breit et al.**

(10) **Patent No.:** **US D829,506 S**

(45) **Date of Patent:** **\*\* Oct. 2, 2018**

(54) **BOTTLE**

(71) Applicant: **O2COOL, LLC**, Chicago, IL (US)

(72) Inventors: **Oliver Breit**, Discovery Bay (HK);  
**Lars Junker**, Kowloon (HK); **Michael Ksiazek**, Burr Ridge, IL (US); **Leonard Scott Huff**, Maryville, TN (US); **Eric F. Junkel**, Mount Prospect, IL (US)

(73) Assignee: **O2COOL, LLC**, Chicago, IL (US)

(\*\*) Term: **15 Years**

(21) Appl. No.: **29/609,886**

(22) Filed: **Jul. 6, 2017**

(51) **LOC (11) Cl.** ..... **07-01**

(52) **U.S. Cl.**  
USPC ..... **D7/510; D7/511; D7/531; D9/567; D9/539**

(58) **Field of Classification Search**  
USPC ..... D7/507, 509, 510, 511, 512, 523, 531, D7/532, 533, 535, 536, 608, 392.1, 396.2, D7/529, 667, 319, 320, 300, 300.1; D9/435, 436, 449, 442, 443, 500, 502, D9/503, 504, 529, 447, 516, 453, 531, D9/567, 539; 220/592.16, 592.17, 62.12, 220/703; D26/7  
CPC ..... A45F 3/16; B65D 47/066; A47J 43/27; A47G 19/2272; A47G 19/2211; A47G 19/22; A47G 19/2222  
See application file for complete search history.

(56) **References Cited**

**U.S. PATENT DOCUMENTS**

D217,585 S *	5/1970	Jose	.....	D9/500
D249,111 S *	8/1978	Geyer	.....	D7/523
D407,980 S *	4/1999	Dinand	.....	D9/500
D428,813 S *	8/2000	Haley	.....	D9/500

D486,996 S *	2/2004	Karp	.....	D7/510
D520,363 S *	5/2006	Perez	.....	D9/500
D529,761 S *	10/2006	Trombly	.....	D7/509
D533,069 S *	12/2006	Archeny	.....	D9/542
D538,597 S *	3/2007	Kim	.....	D7/510
D579,333 S *	10/2008	Dixon	.....	D9/500
D580,709 S *	11/2008	Williams	.....	D7/509
D581,216 S *	11/2008	Williams	.....	D7/509
D597,365 S *	8/2009	Oas	.....	D7/300.1
D621,648 S *	8/2010	Lown	.....	D7/300.1
D696,905 S *	1/2014	Carreno	.....	D7/509
D728,297 S *	5/2015	Melzer	.....	D7/300.1
D735,043 S *	7/2015	Herbst	.....	D9/539
D758,133 S *	6/2016	Peng	.....	D7/510
D763,076 S *	8/2016	Lane	.....	D9/446
D789,745 S *	6/2017	Rashid	.....	D7/523
D798,664 S *	10/2017	Kristinik	.....	D7/509
9,913,552 B2 *	3/2018	Elsaden	.....	A47G 19/2272
2014/0151390 A1 *	6/2014	Kohler	.....	A47G 19/12 220/825

(Continued)

*Primary Examiner* — Marianne Pandozzi

*Assistant Examiner* — Jae Liang

(74) *Attorney, Agent, or Firm* — Thompson Coburn LLP

(57) **CLAIM**

The ornamental design for a bottle, as shown and described.

**DESCRIPTION**

FIG. 1 is a first perspective view of a bottle showing our new design;  
FIG. 2 is a second perspective view thereof;  
FIG. 3 is a left side view thereof;  
FIG. 4 is a right side view thereof;  
FIG. 5 is a front view thereof;  
FIG. 6 is a rear view thereof;  
FIG. 7 is a top view thereof; and,  
FIG. 8 is a bottom view thereof.  
The broken lines in the drawings depict portions of the bottle that form no part of the claimed design.

**1 Claim, 7 Drawing Sheets**

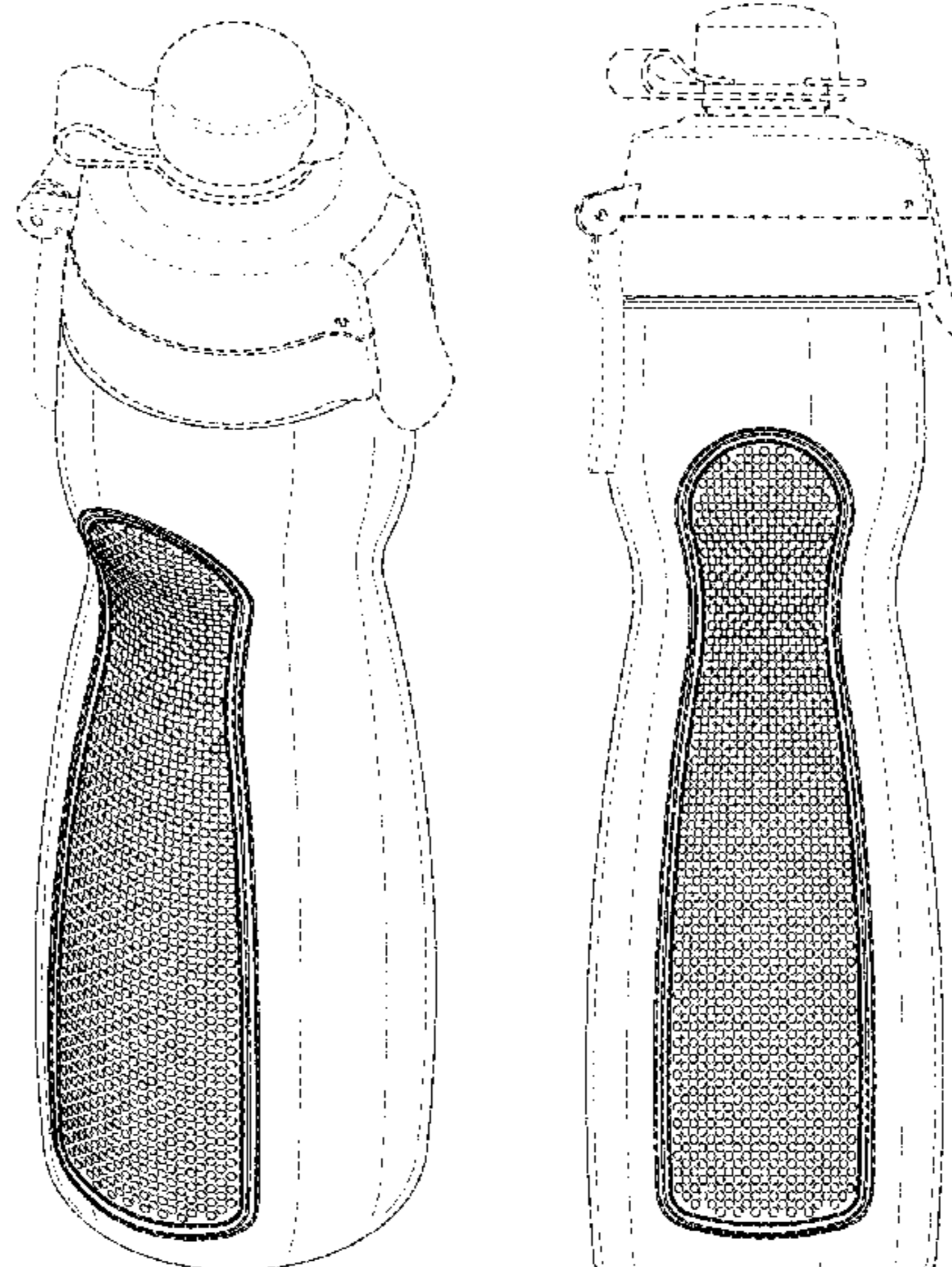

(56)

**References Cited**

U.S. PATENT DOCUMENTS

2016/0206082 A1\* 7/2016 Gottlieb ..... A45F 3/16

\* cited by examiner

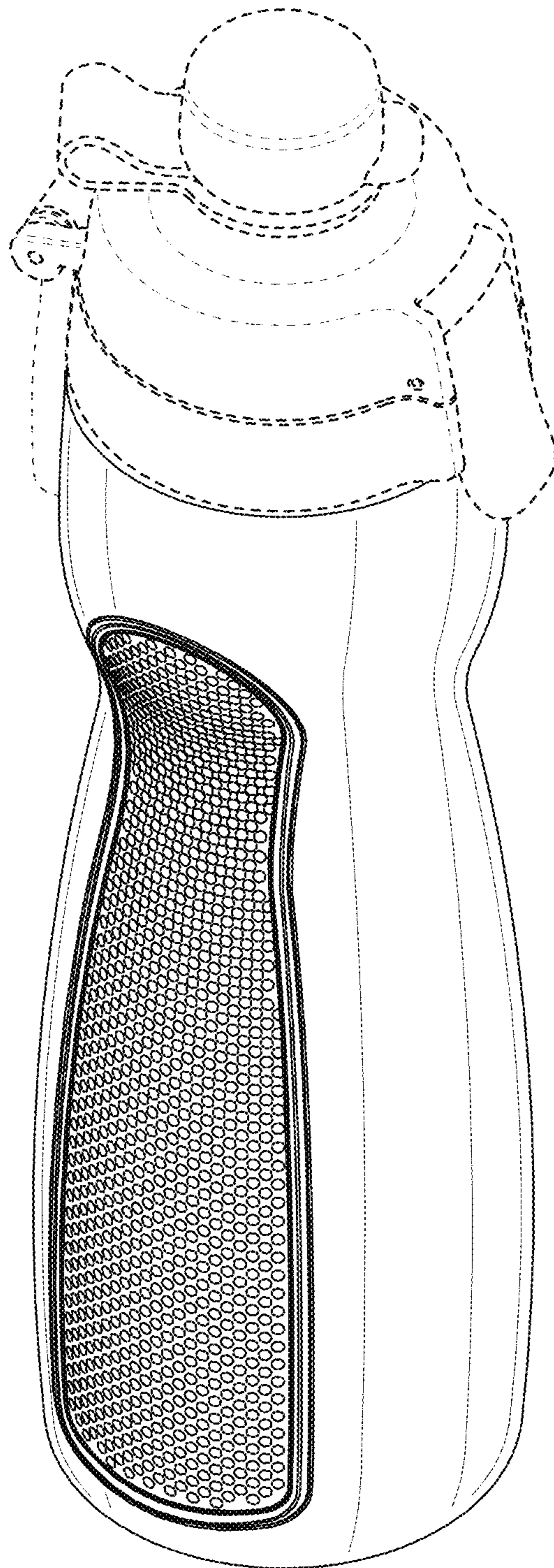

FIG. 1

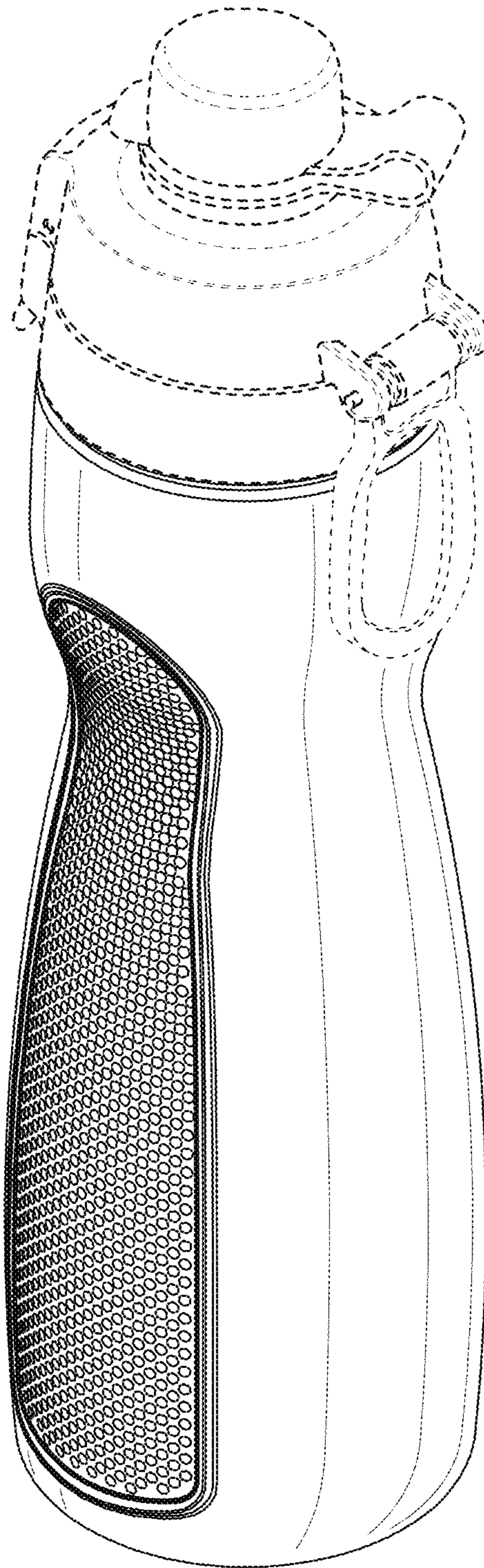

FIG. 2

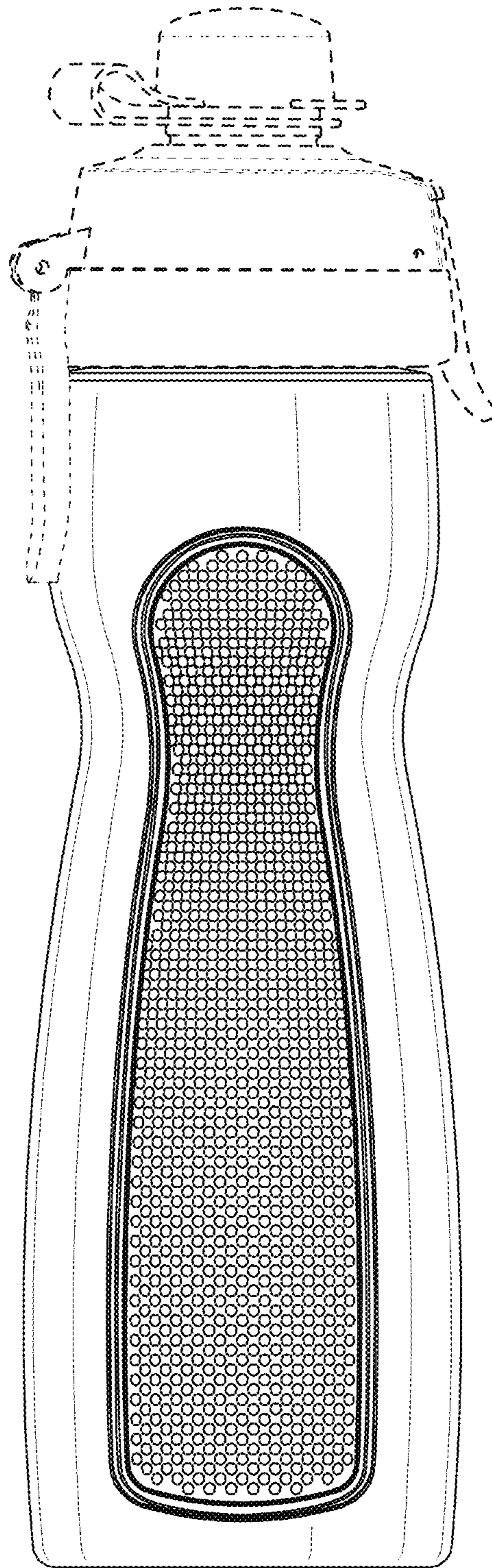

FIG. 3

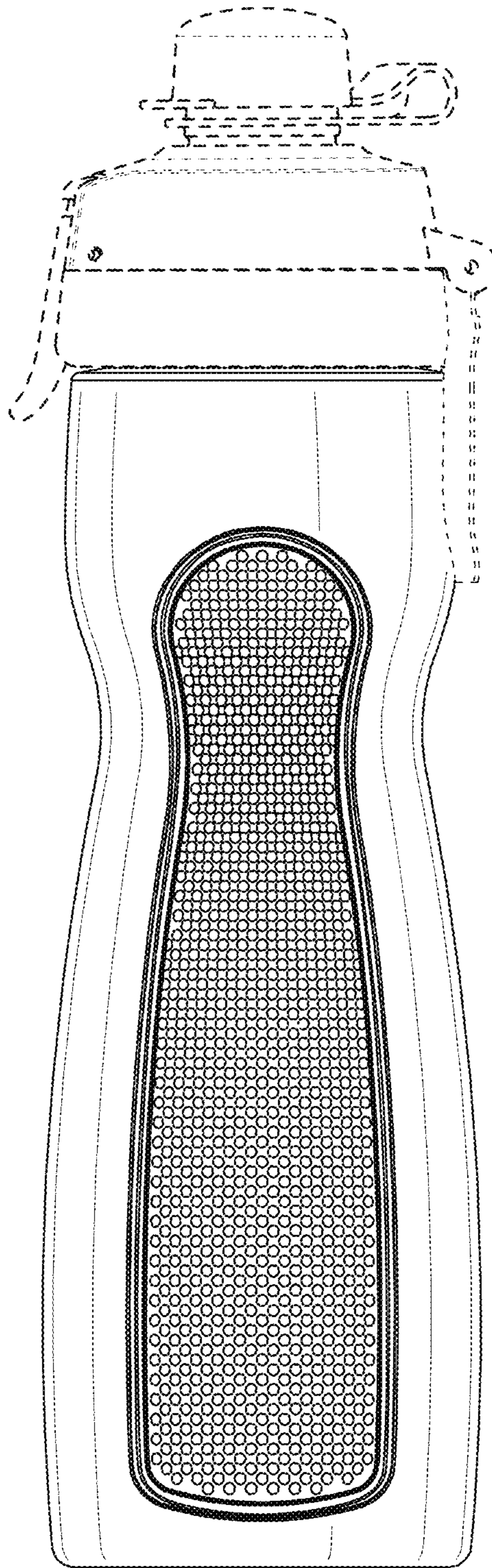

FIG. 4

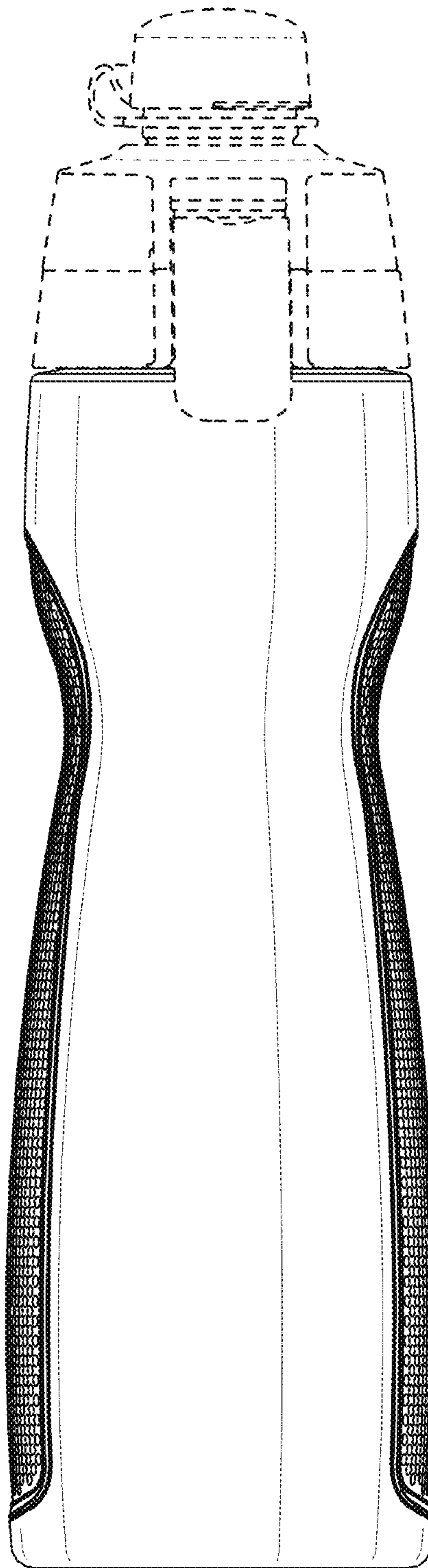

FIG. 5

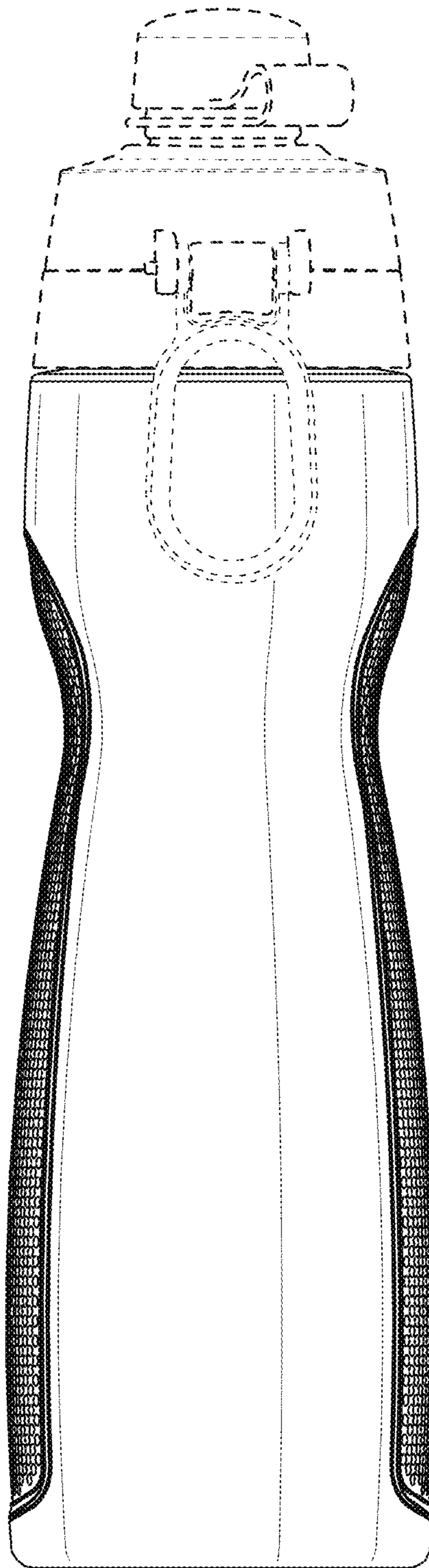

FIG. 6



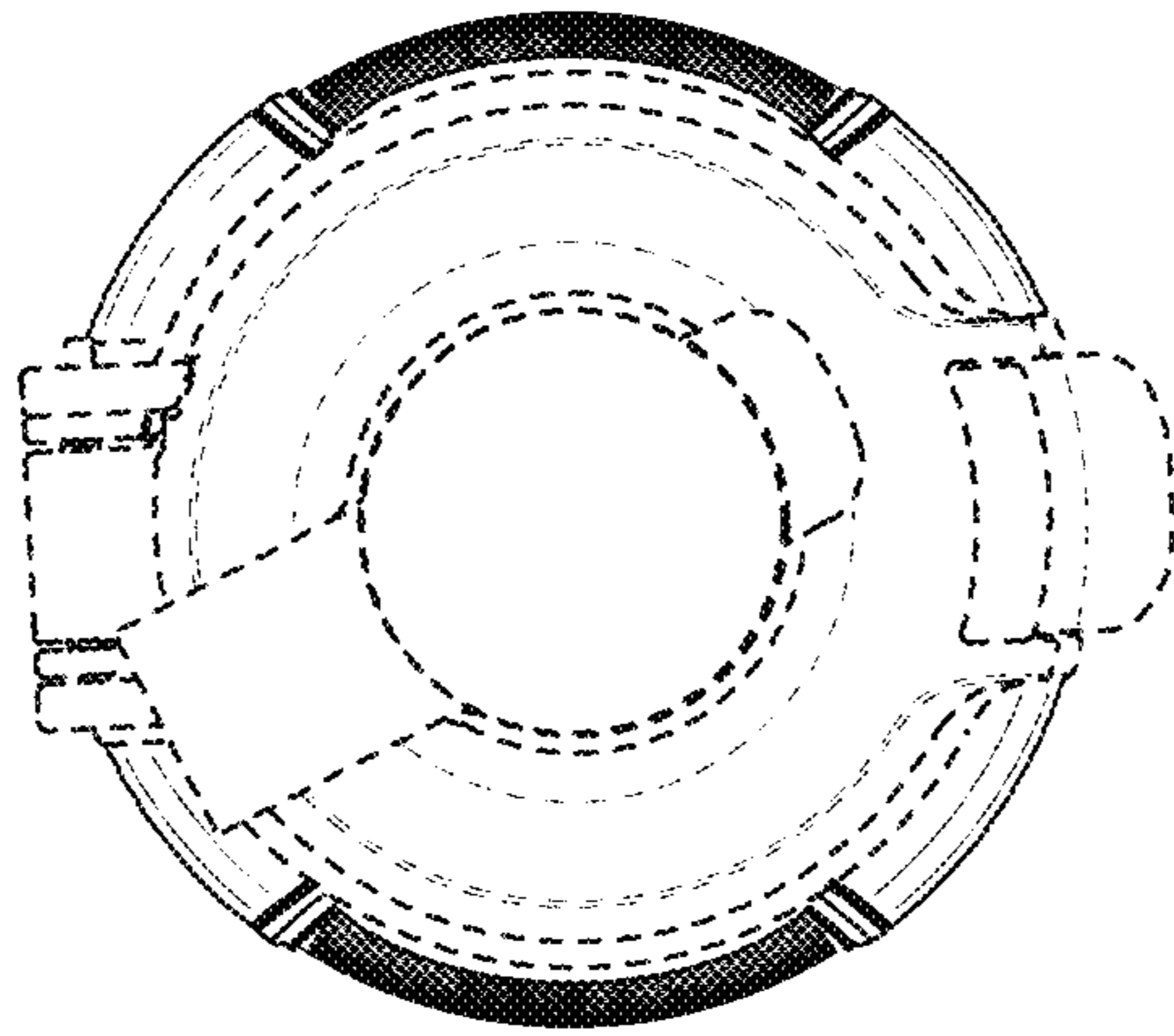

FIG. 7

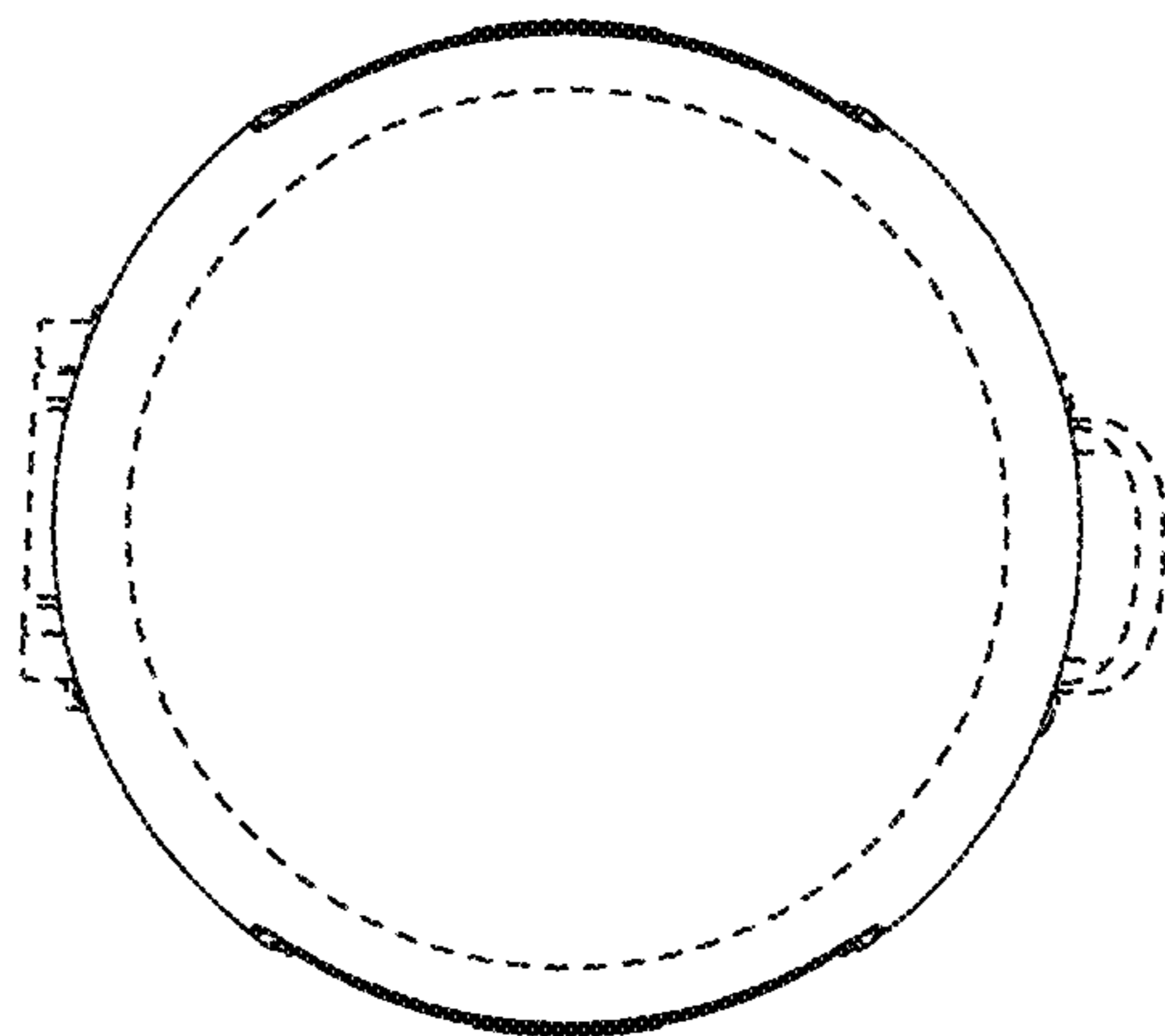

FIG. 8