



US00D829499S

(12) **United States Design Patent** (10) **Patent No.:** **US D829,499 S**  
**Colston** (45) **Date of Patent:** **\*\* Oct. 2, 2018**

(54) **GRILL BASKET**

(71) Applicant: **Traeger Pellet Grills LLC**, Salt Lake City, UT (US)

(72) Inventor: **Michael Colston**, Salt Lake City, UT (US)

(73) Assignee: **Traeger Pellet Grills, LLC**, Salt Lake City, UT (US)

(\*\*) Term: **15 Years**

(21) Appl. No.: **29/558,106**

(22) Filed: **Mar. 15, 2016**

(51) **LOC (11) Cl.** ..... **07-99**

(52) **U.S. Cl.**  
USPC ..... **D7/402**

(58) **Field of Classification Search**  
USPC ..... D7/402, 403, 323, 339, 347, 354, 361, D7/362, 368, 667, 668, 669, 674, 677, D7/688, 690, 692, 695, 369, 387, 388, D7/396.6, 407, 213, 409, 416, 332  
CPC ..... A21B 1/48  
See application file for complete search history.

(56) **References Cited**

**U.S. PATENT DOCUMENTS**

4,777,927	A *	10/1988	Stephen	.....	A47J 37/0704
					126/25 R
D301,431	S *	6/1989	Landis	.....	D7/402
5,074,279	A *	12/1991	Sainsbury	.....	A47J 37/0786
					126/145
D325,249	S *	4/1992	Kliebert	.....	D23/308
D395,979	S *	7/1998	Picozza	.....	D7/334
D404,610	S *	1/1999	Besette	.....	D7/402
D472,422	S *	4/2003	Pai	.....	D7/334
D474,063	S *	5/2003	Eisinger	.....	D7/334
D479,430	S *	9/2003	Chung	.....	D7/334
D483,215	S *	12/2003	Eisinger	.....	D7/334
D491,010	S *	6/2004	Chung	.....	D7/334

D496,821	S *	10/2004	Pai	.....	D7/334
D511,924	S *	11/2005	Chung	.....	D7/334
D512,263	S *	12/2005	Chung	.....	D7/334
D526,833	S *	8/2006	Chung	.....	D7/334
D526,834	S *	8/2006	Chung	.....	D7/334
D528,847	S *	9/2006	Chung	.....	D7/334
D532,652	S *	11/2006	Powell	.....	D7/402
D534,034	S *	12/2006	Chambers	.....	D7/402
D550,023	S *	9/2007	Chung	.....	D7/334

(Continued)

**OTHER PUBLICATIONS**

Traeger TV Renegade Elite Grill Traeger Wood Fired Grills, [online], [site visited Nov. 1, 2017]. Available from Internet, URL:<http://www.traegergrills.com/renegade-elite.html>.\*

(Continued)

*Primary Examiner* — Caron D Veynar  
*Assistant Examiner* — Katrina N Gonzalez  
(74) *Attorney, Agent, or Firm* — Workman Nydegger

(57) **CLAIM**

The ornamental design for a grill basket, as shown and described.

**DESCRIPTION**

FIG. 1 is a front perspective view of a grill basket showing my new design in a configuration of use;  
FIG. 2 is a front perspective view of the grill basket;  
FIG. 3 is a front elevation view thereof;  
FIG. 4 is a rear elevation view thereof;  
FIG. 5 is a top plan view thereof;  
FIG. 6 is a bottom plan view thereof;  
FIG. 7 is a right side elevation view thereof; and,  
FIG. 8 is a left side elevation view thereof.  
The broken lines in the drawings depict environmental subject matter and portions of the grill basket that form no part of the claimed design.

**1 Claim, 5 Drawing Sheets**

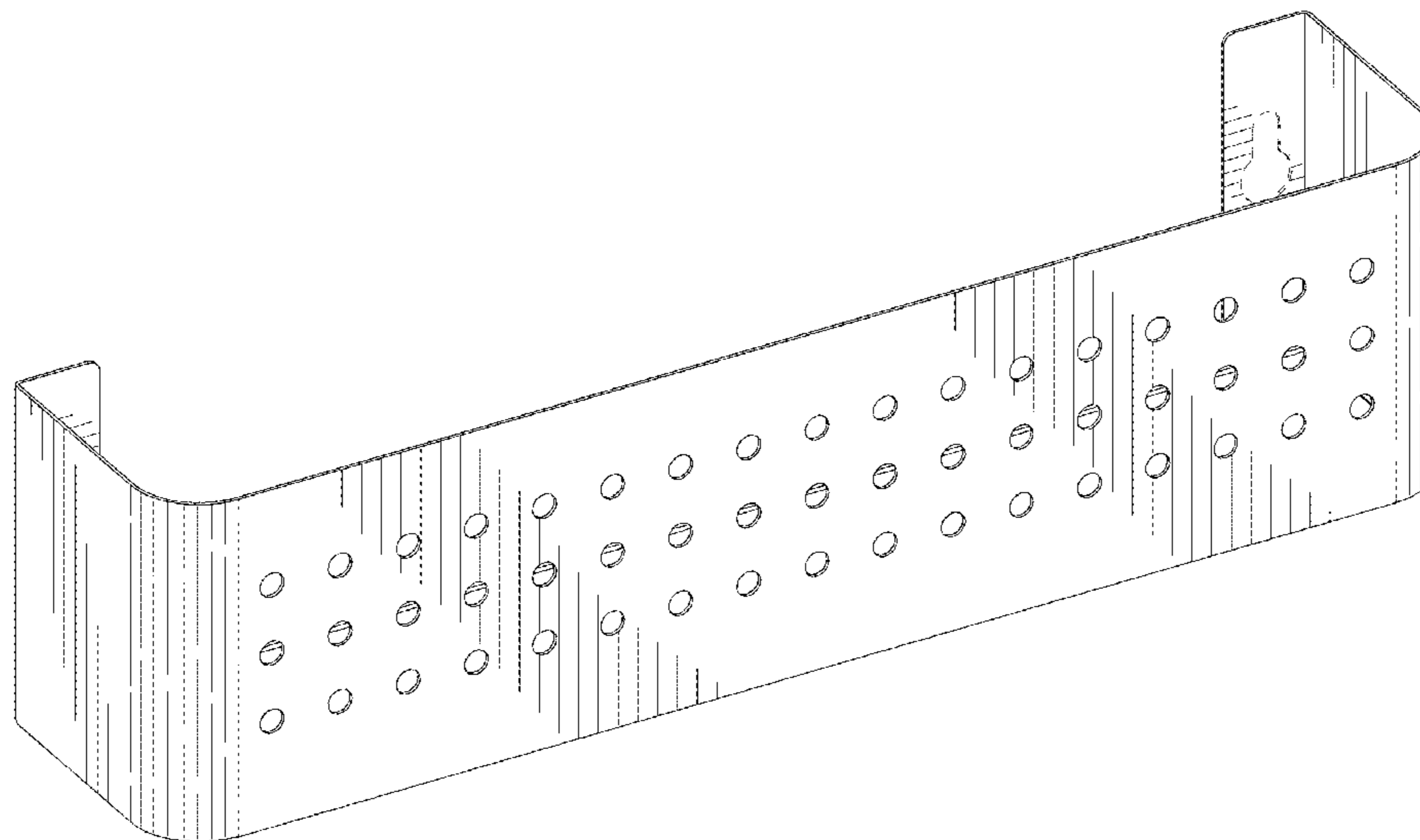

(56)

**References Cited**

U.S. PATENT DOCUMENTS

D607,262 S \* 1/2010 Chung ..... D7/334  
D752,913 S \* 4/2016 Taylor ..... D7/354

OTHER PUBLICATIONS

LTL More Inside Mountable Mesh Basket \_ Staples, [online], [site visited Nov. 1, 2017]. Available from Internet, URL:[https://www.staples.com/LTL-More-Inside-Mountable-Mesh-Basket/product\\_WYF078278658423](https://www.staples.com/LTL-More-Inside-Mountable-Mesh-Basket/product_WYF078278658423).\*

Metro H209K3 Green Rectangular Smartwall G3 Storage Basket, [online], [site visited Nov. 1, 2017]. Available from Internet, URL: <https://www.culinarydepotinc.com/metro-h209k3-green-rectangular-smartwall-g3-storage-basket>.\*

Hafele 540.36.207 Chrome 12.75\_ Wide Steel Wire Hanging 3-Sided Basket—PullsDirect, [online], [site visited Nov. 1, 2017]. Available from Internet, URL: <https://www.pulldirect.com/hafele-540-36-207-12-75-wide-steel-wire-hanging-3-sided-basket/p1587943>.\*

\* cited by examiner

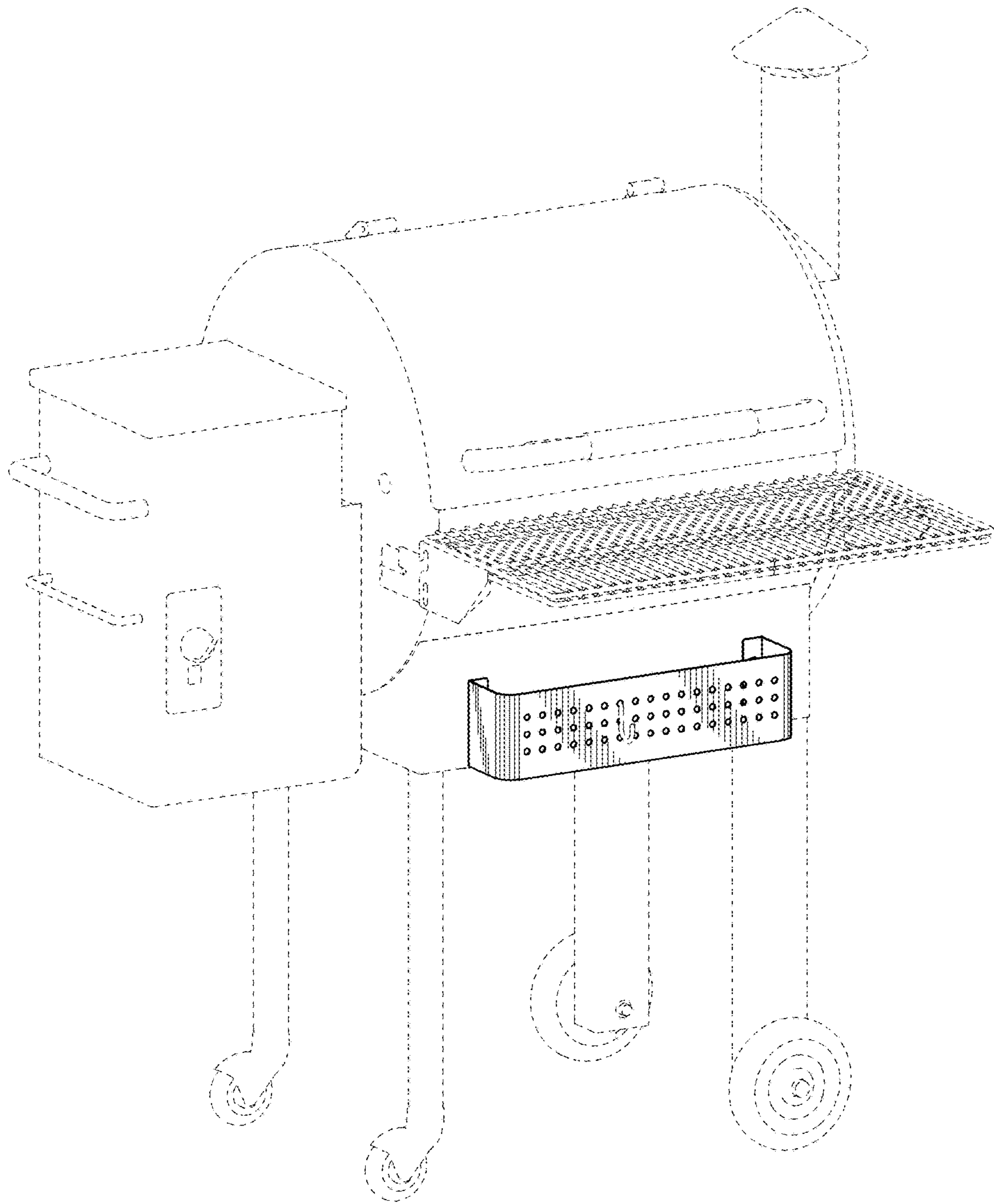

**FIG. 1**

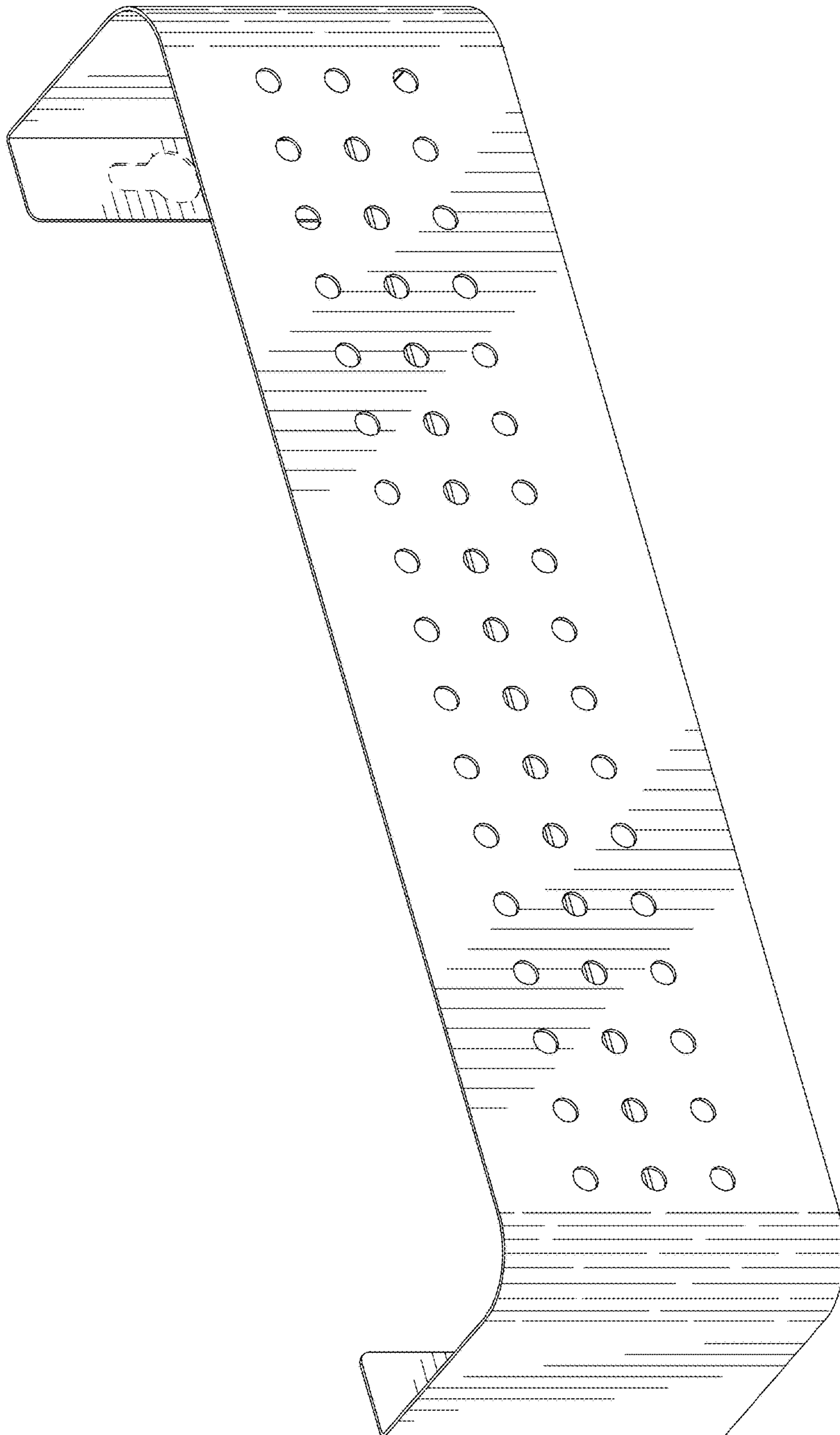

FIG. 2

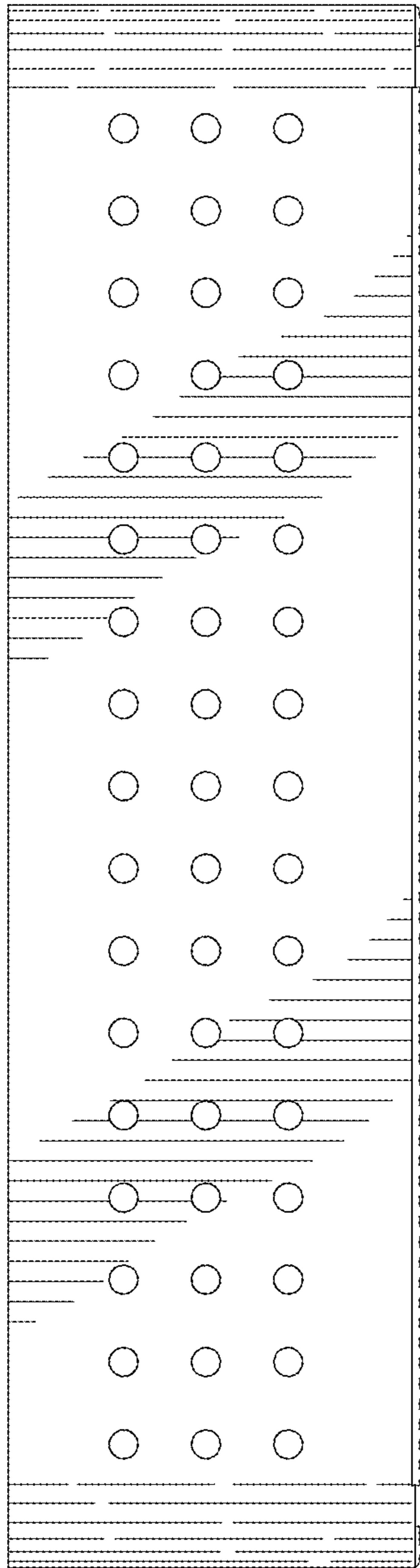

FIG. 3

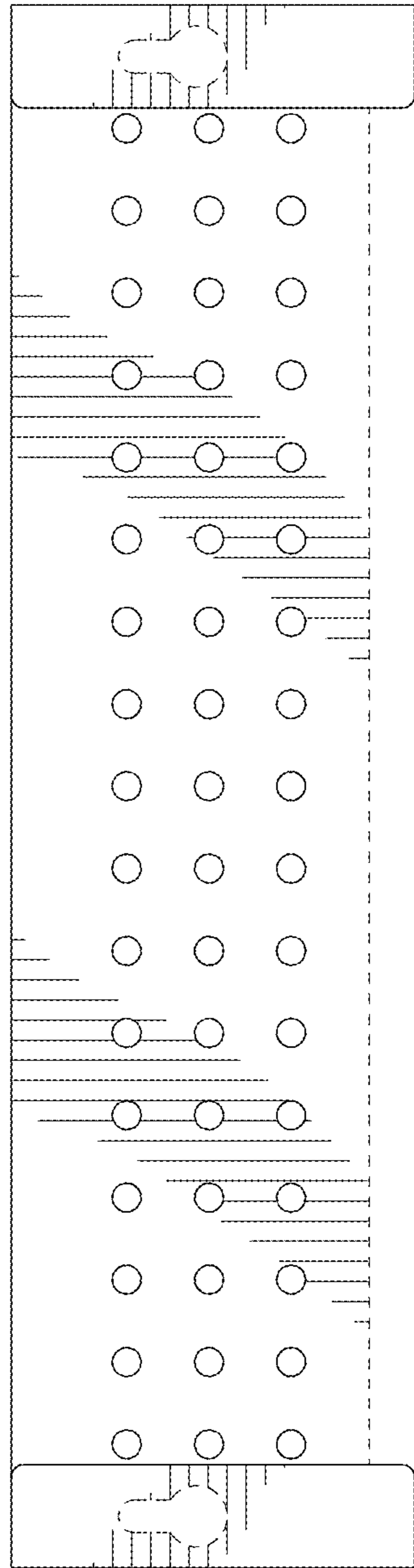

FIG. 4

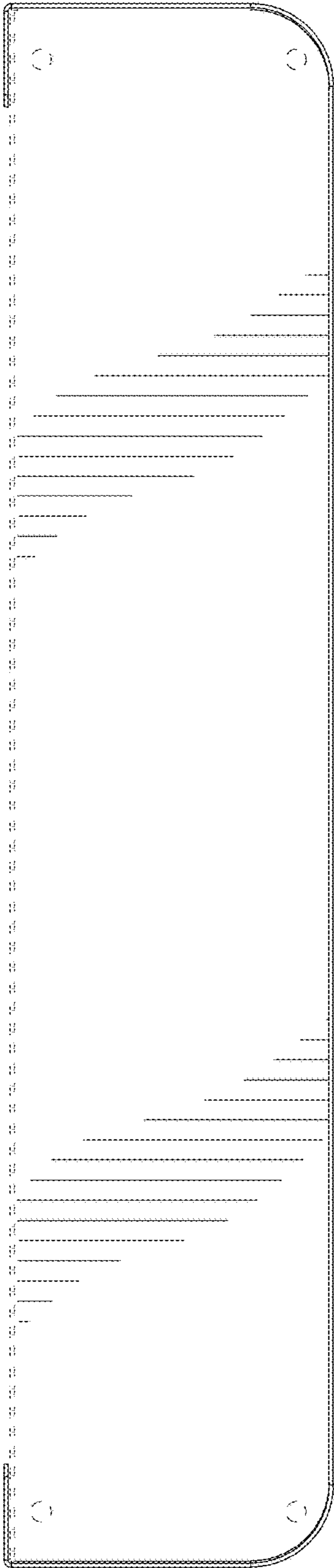

FIG. 5

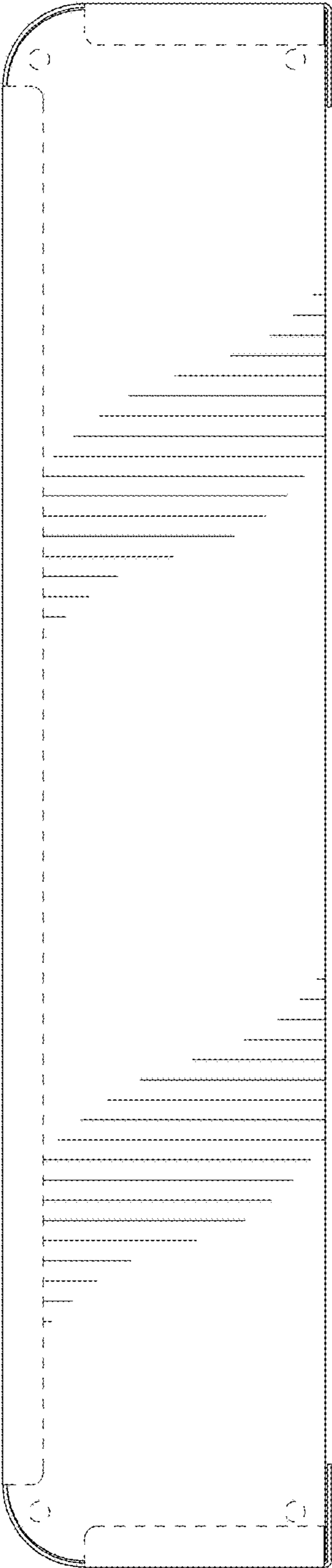
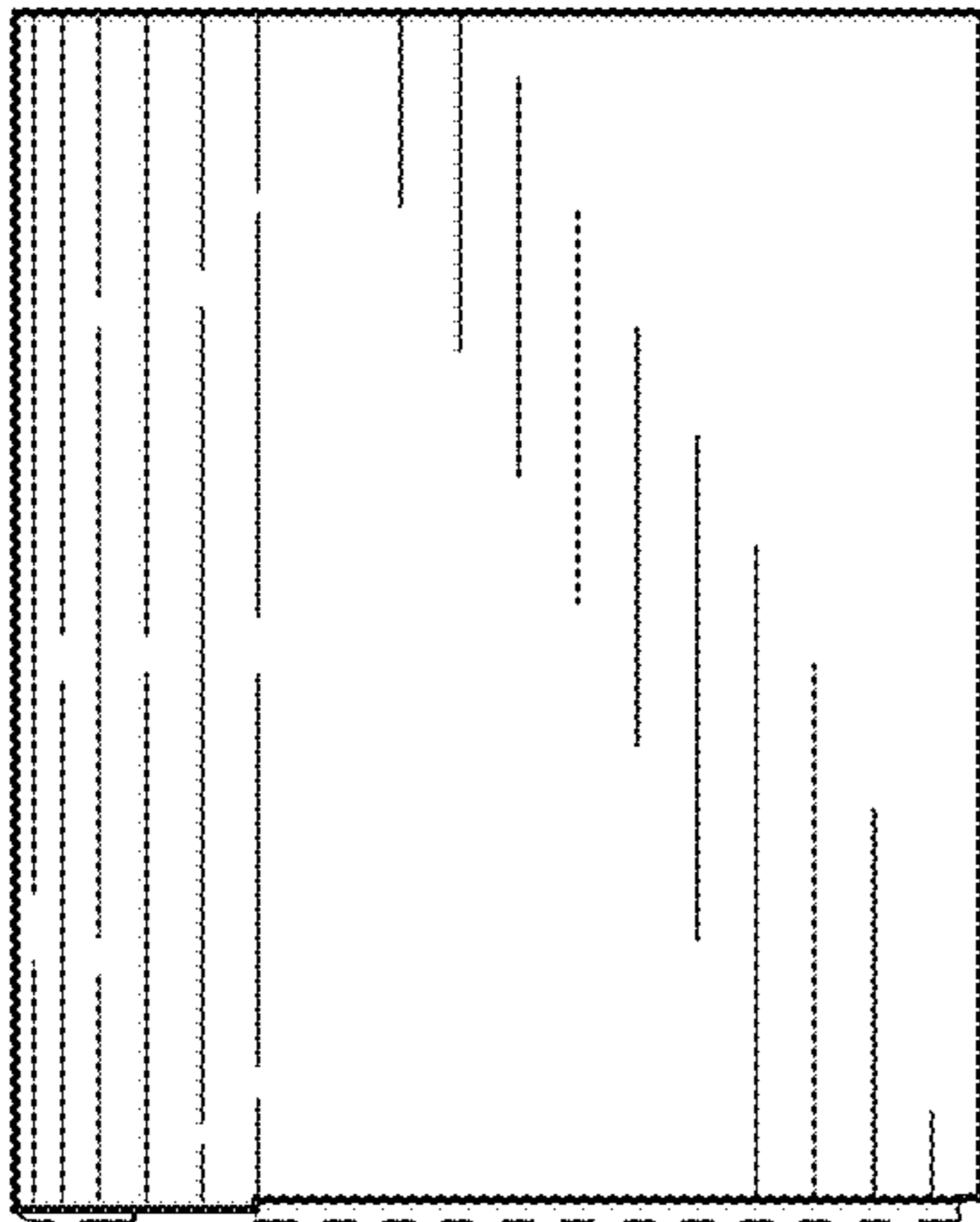
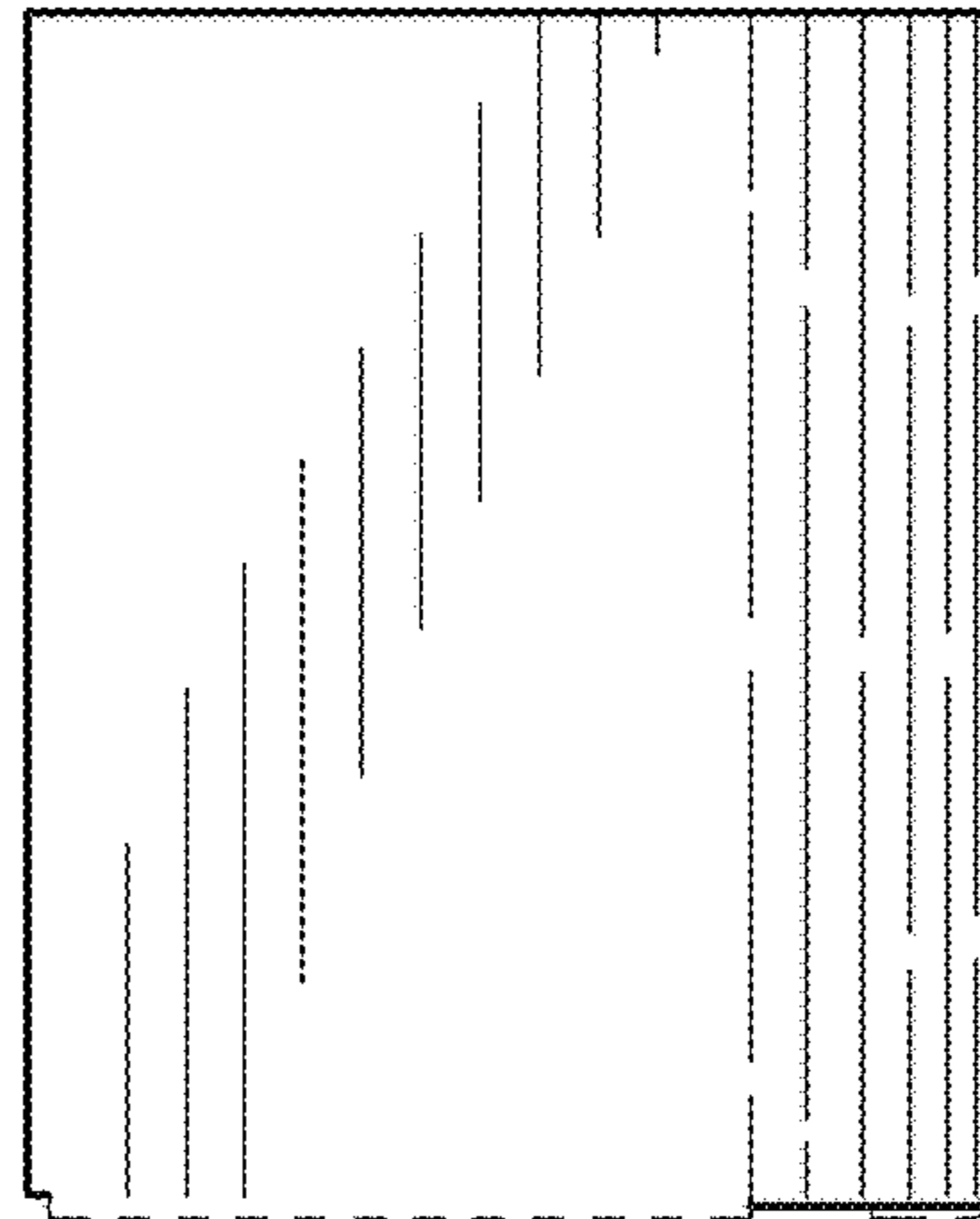

FIG. 6



**FIG. 7**



**FIG. 8**