



US00D829476S

(12) **United States Design Patent**
Bernardi

(10) **Patent No.:** **US D829,476 S**

(45) **Date of Patent:** **** Oct. 2, 2018**

(54) **DINING TABLE**

(71) Applicant: **J & R Household Co., Ltd.**, Shanghai
(CN)

(72) Inventor: **Lodovico Bernardi**, Vittorio Veneto
(IT)

(73) Assignee: **J & R Household Co., Ltd.**, Shanghai
(CN)

(**) Term: **15 Years**

(21) Appl. No.: **29/590,325**

(22) Filed: **Jan. 9, 2017**

(51) **LOC (11) Cl.** **06-03**

(52) **U.S. Cl.**
USPC **D6/691.1**

(58) **Field of Classification Search**
USPC D6/641, 685, 689, 690, 691, 691.1,
D6/691.2, 691.3, 691.4, 691.5, 691.6,
D6/691.7, 691.8, 691.9, 702, 703.1,
D6/703.4, 707.15

CPC .. A47B 37/00; A47B 3/00; A47B 1/00; A47B
3/06; A47B 3/08; A47B 7/00; A47B
21/00; A47B 23/00; A47B 25/00; A47B
13/08; A47B 3/083; A47B 3/14; A47B
17/00; A47B 3/0809; A47B 3/0812; A47B
2013/026; A47B 2200/03; A47B 2200/00;
A47B 2003/0821; A47C 3/045

See application file for complete search history.

(56) **References Cited**

U.S. PATENT DOCUMENTS

D415,909 S * 11/1999 Valderen D6/685
D461,330 S * 8/2002 Wang D6/349
D475,869 S * 6/2003 Jackson D6/691.1
9,215,923 B1 * 12/2015 Boone A47B 13/021
D772,621 S * 11/2016 Levy D6/691

D779,862 S * 2/2017 Everson D6/691.1
D784,744 S * 4/2017 Burden D6/691
D792,134 S * 7/2017 Bougay D6/691
D797,478 S * 9/2017 Merritt D6/691
D801,092 S * 10/2017 Merritt D6/691
2010/0043679 A1* 2/2010 Laws A47B 95/043
108/64
2016/0058173 A1* 3/2016 Green A47B 88/407
108/26
2017/0138380 A1* 5/2017 Leng E06C 1/387

OTHER PUBLICATIONS

Coaster 103061, posted at Amazon.com, posted on Apr. 4, 2015, site visited Feb. 13, 2018. online, available from internet: <https://www.amazon.com/Coaster-103061-Home-Furnishings-Chestnut/dp/B00J9YT99G>.*

* cited by examiner

Primary Examiner — Mary Ann Calabrese

Assistant Examiner — Catherine Ho

(74) *Attorney, Agent, or Firm* — Loza & Loza, LLP;
Michael F. Fedrick

(57) **CLAIM**

I claim the ornamental design for a dining table, as shown and described.

DESCRIPTION

FIG. 1 is a perspective view of the present invention;
FIG. 2 is a right side elevation view thereof;
FIG. 3 is an enlarged sectional view thereof taken in the direction of line 3-3 of FIG. 2;
FIG. 4 is a left side elevation view of FIG. 1;
FIG. 5 is a front elevation view thereof;
FIG. 6 is a rear elevation view thereof;
FIG. 7 is a top view thereof; and,
FIG. 8 is a bottom view thereof.

1 Claim, 8 Drawing Sheets

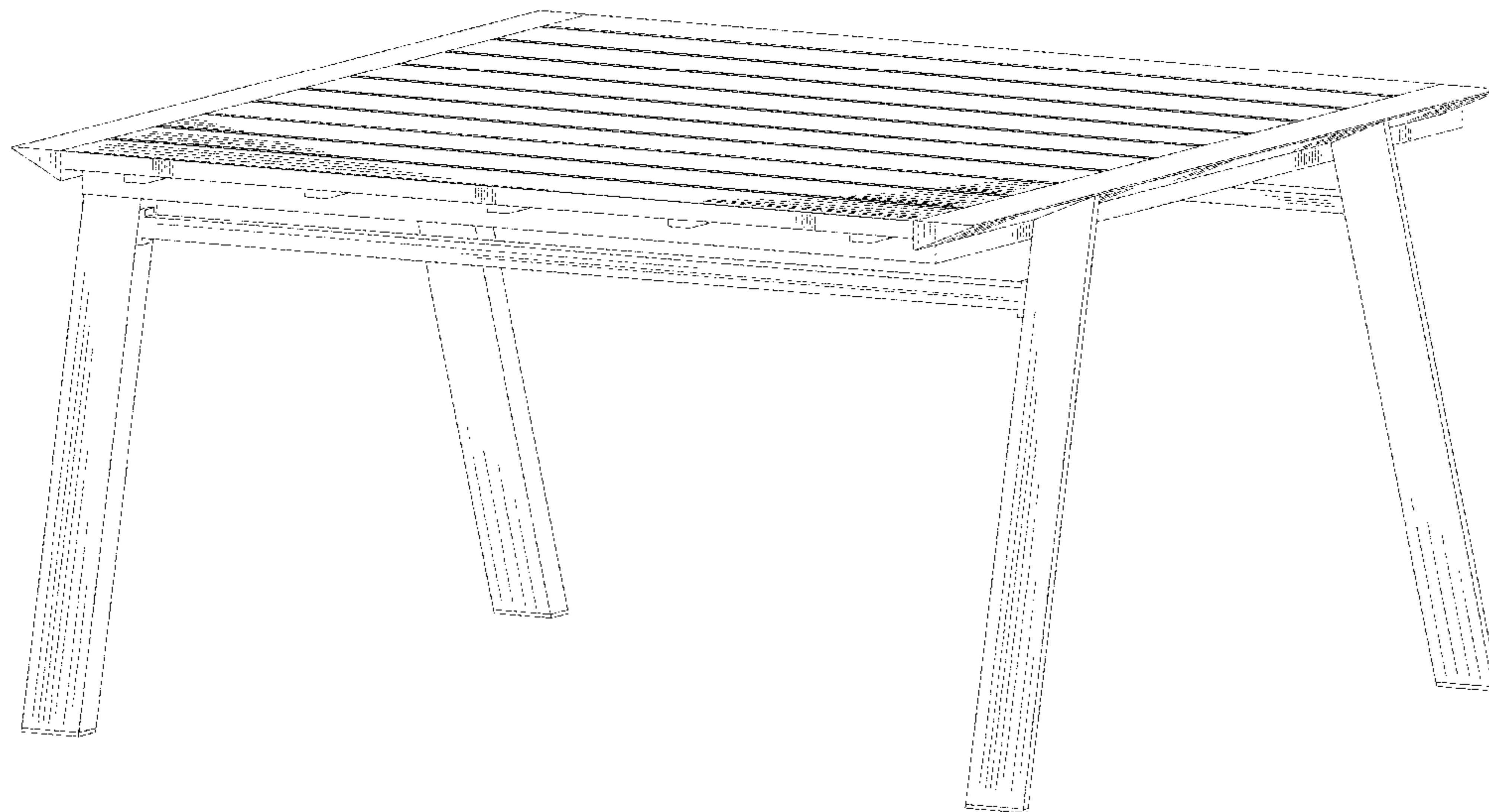

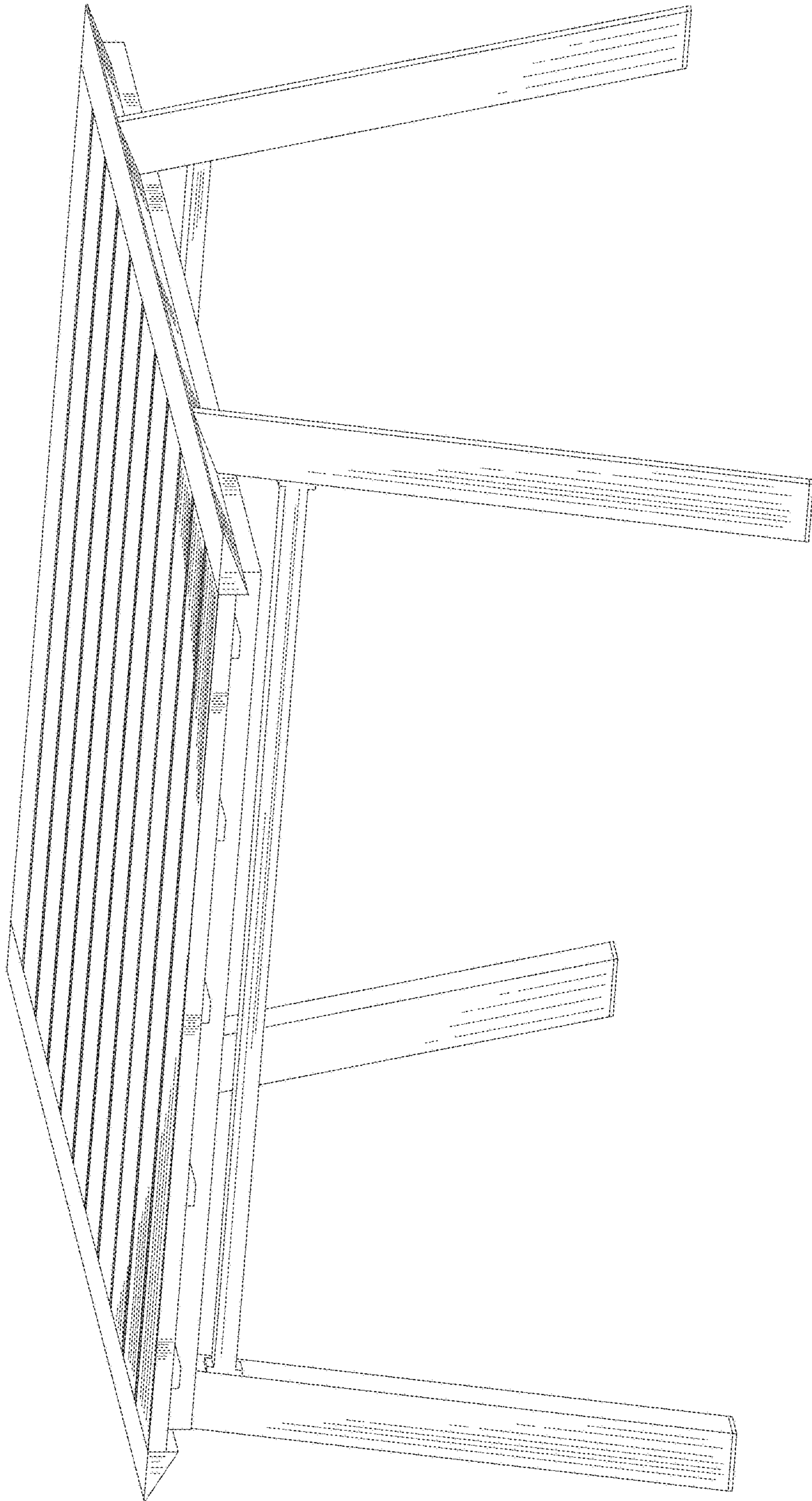

FIG. 1

Figure 2

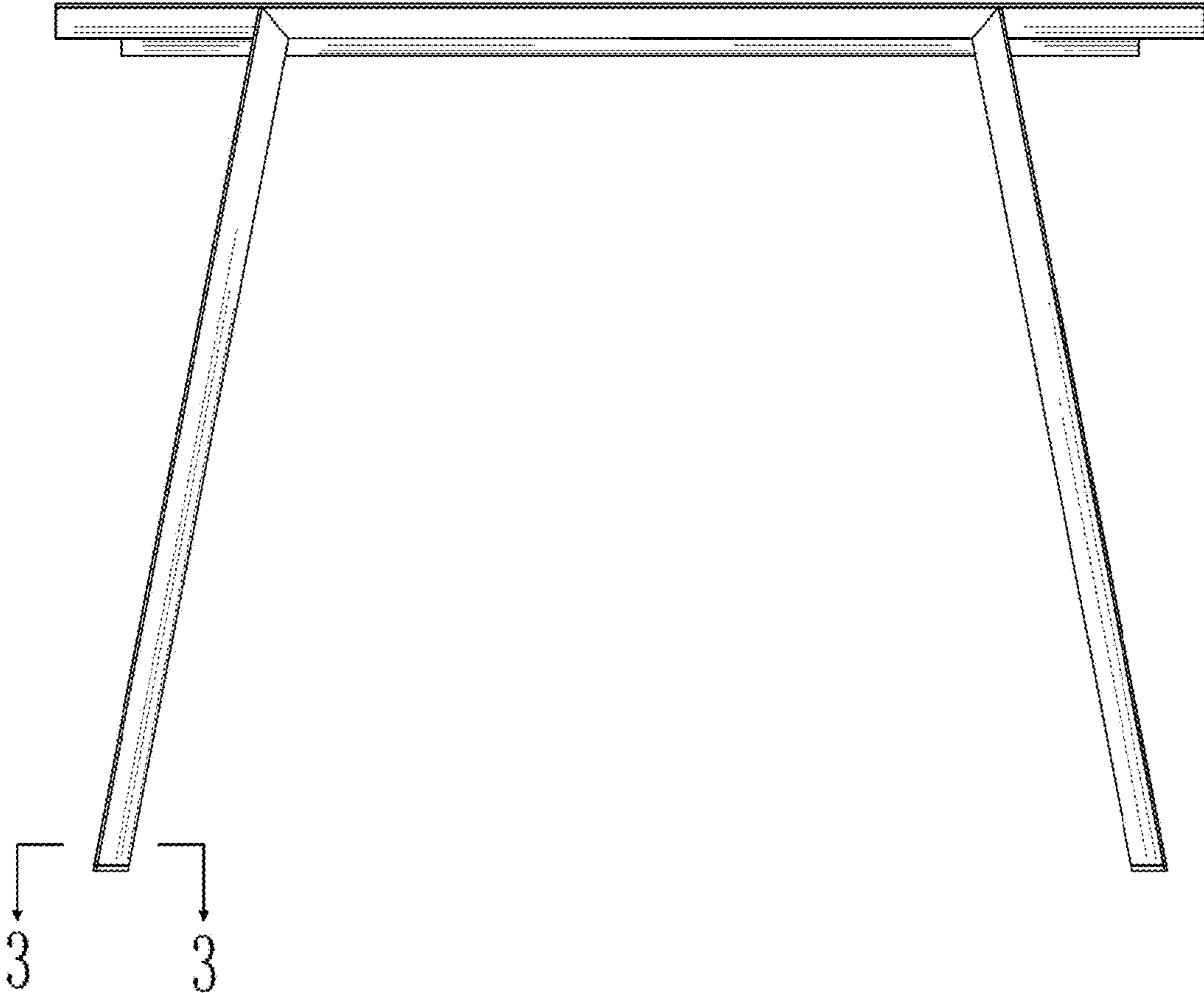

Figure 3

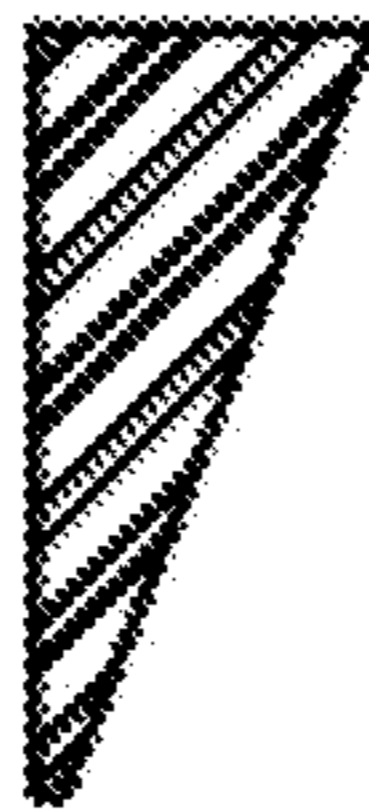

Figure 4

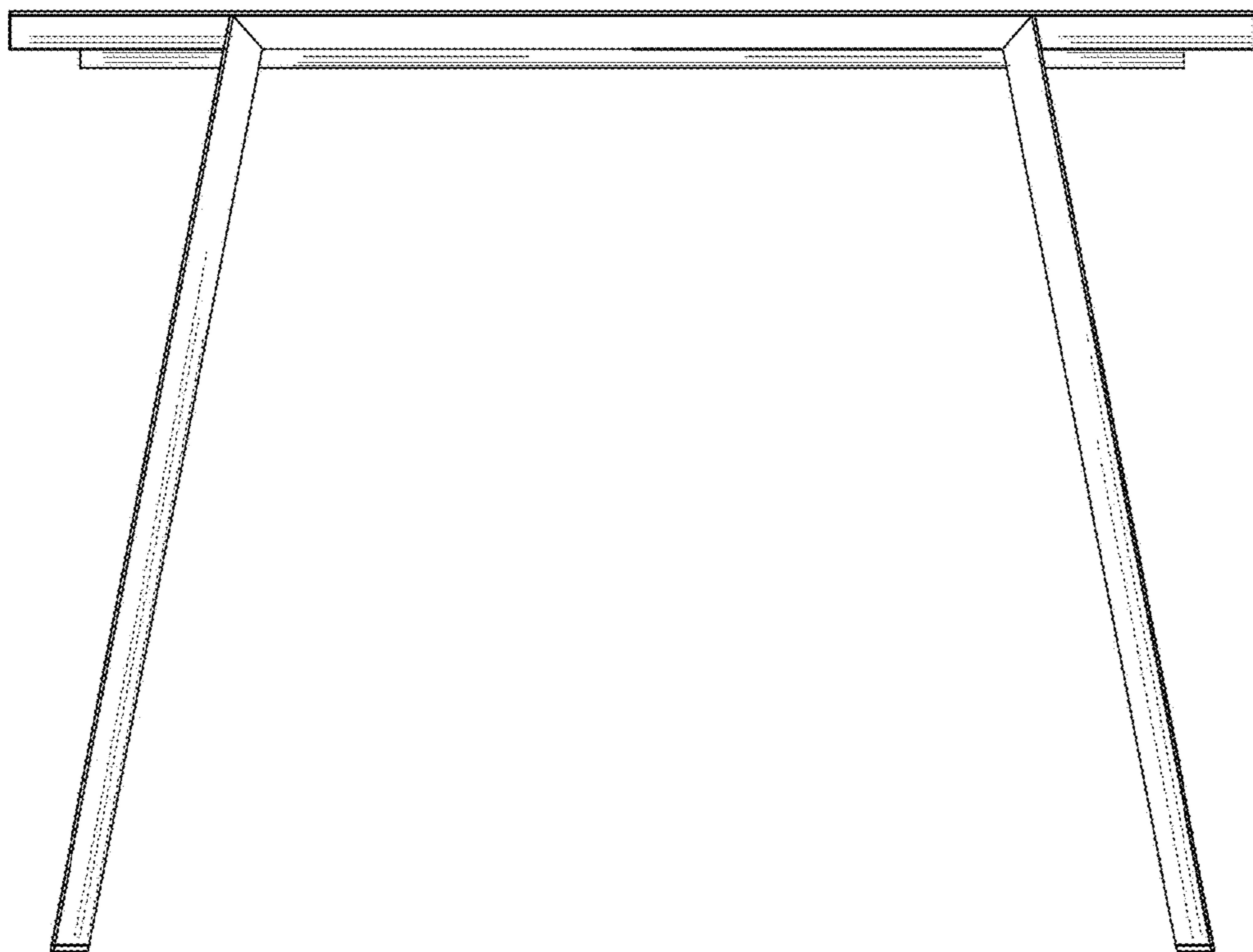

Figure 5

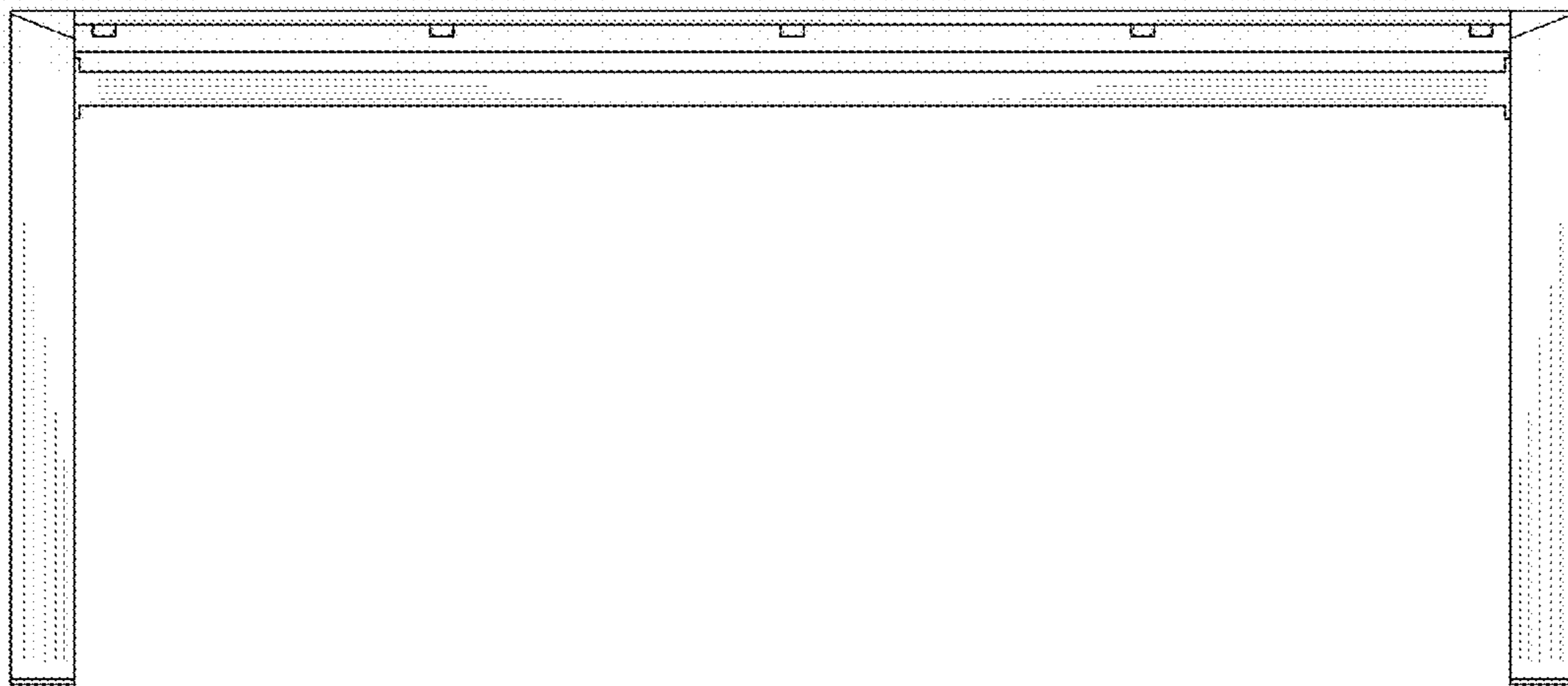

Figure 6

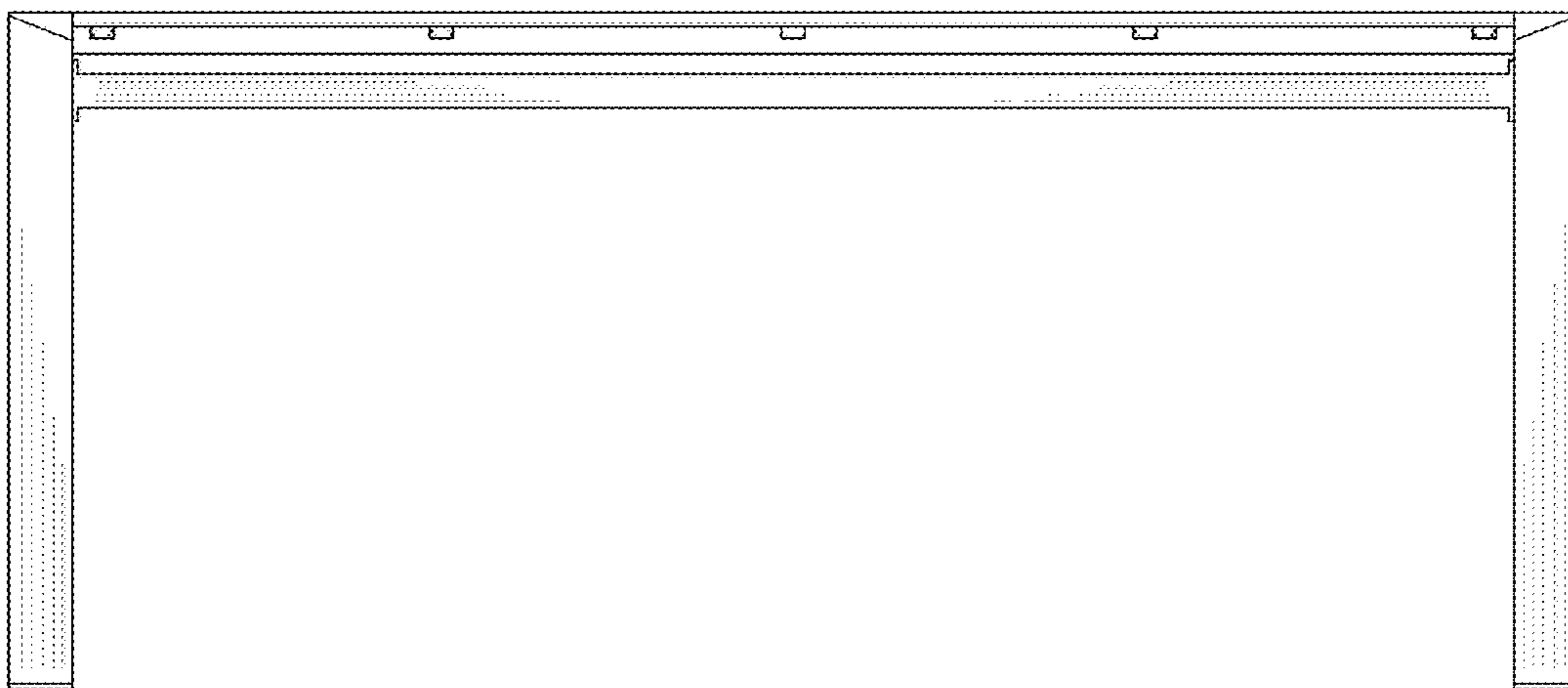

Figure 7

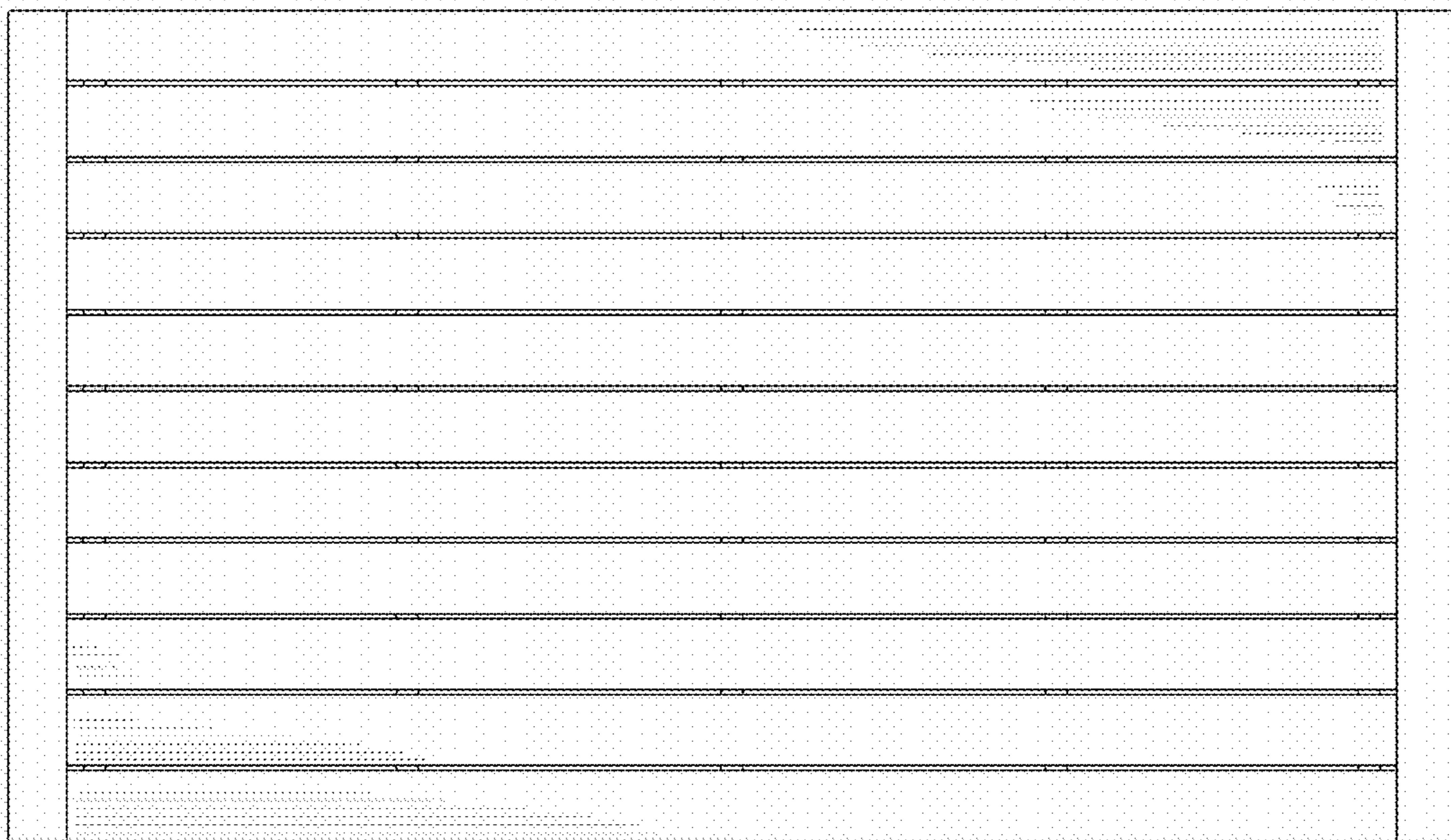

Figure 8

