



US00D829475S

(12) **United States Design Patent**  
**Davis et al.**

(10) **Patent No.:** **US D829,475 S**

(45) **Date of Patent:** **\*\* Oct. 2, 2018**

- (54) **TABLE**
- (71) Applicant: **WALKER EDISON FURNITURE COMPANY, LLC**, Salt Lake City, UT (US)
- (72) Inventors: **Matthew Davis**, Murray, UT (US); **Brad Bonham**, Draper, UT (US)
- (73) Assignee: **WALKER EDISON FURNITURE COMPANY, LLC**, Salt Lake City, UT (US)
- (\*\*) Term: **15 Years**
- (21) Appl. No.: **29/574,032**
- (22) Filed: **Aug. 11, 2016**
- (51) **LOC (11) Cl.** ..... **06-03**
- (52) **U.S. Cl.**  
USPC ..... **D6/691**
- (58) **Field of Classification Search**  
USPC ..... D6/642, 663, 671, 677, 686, 687, 690, D6/691, 691.1, 691.2, 691.3, 691.4, D6/691.5, 693, 689, 691.9, 695, 695.2  
CPC ..... A47B 7/00; A47B 13/08; A47B 13/10; A47B 21/00; A47B 2009/006; A47B 11/00; A47B 2200/002  
See application file for complete search history.

- D214,741 S \* 7/1969 Dean ..... D6/691.8
- D300,889 S \* 5/1989 Bartlett ..... D6/691
- D334,312 S \* 3/1993 Glass ..... D6/691.8
- D371,700 S \* 7/1996 Rosen ..... D6/694
- D468,561 S \* 1/2003 De Blaay ..... D6/691
- D493,983 S \* 8/2004 Di Guglielmo ..... D6/691.8
- D503,298 S \* 3/2005 Juneau ..... D6/691
- D513,908 S \* 1/2006 Bibi ..... D6/691.1
- D531,431 S \* 11/2006 Domack ..... D6/691.2
- D573,374 S \* 7/2008 Vasileiou ..... D6/690
- D575,964 S \* 9/2008 Liu ..... D6/697
- D641,996 S \* 7/2011 Wahl ..... D6/691.8
- D653,879 S \* 2/2012 Najarian ..... D6/691.1
- D660,616 S \* 5/2012 Kitagawara ..... D6/691
- D683,161 S \* 5/2013 Polloni ..... D6/691.8
- D717,082 S \* 11/2014 Dworman ..... D6/657
- D761,364 S \* 7/2016 Summerville, Jr. .... D21/349
- D772,621 S \* 11/2016 Levy ..... D6/691
- D786,591 S \* 5/2017 Grabowski ..... D6/691
- D792,134 S \* 7/2017 Bougay ..... D6/691

\* cited by examiner

*Primary Examiner* — Mary Ann Calabrese

*Assistant Examiner* — Sloan Rozin

(74) *Attorney, Agent, or Firm* — Workman Nydegger

(56) **References Cited**

**U.S. PATENT DOCUMENTS**

- 2,614,013 A \* 10/1952 Langius ..... A47B 1/08 108/69
- D175,195 S \* 7/1955 Streng ..... D6/691.8
- 2,734,788 A \* 2/1956 Elles ..... A47B 1/04 108/79
- D205,291 S \* 7/1966 Klein ..... D6/691
- 3,419,317 A \* 12/1968 Mutchnik ..... A47B 1/08 108/83

(57) **CLAIM**

The ornamental design for a table, as shown and described.

**DESCRIPTION**

FIG. 1 is a front perspective view of a table;  
 FIG. 2 is a right elevation view thereof;  
 FIG. 3 is a left elevation view thereof;  
 FIG. 4 is a top plan view thereof;  
 FIG. 5 is a bottom plan view thereof;  
 FIG. 6 is a front elevation view thereof; and,  
 FIG. 7 is a rear elevation view thereof.  
 The broken lines illustrate portions of the table that form no part of the claimed design.

**1 Claim, 4 Drawing Sheets**

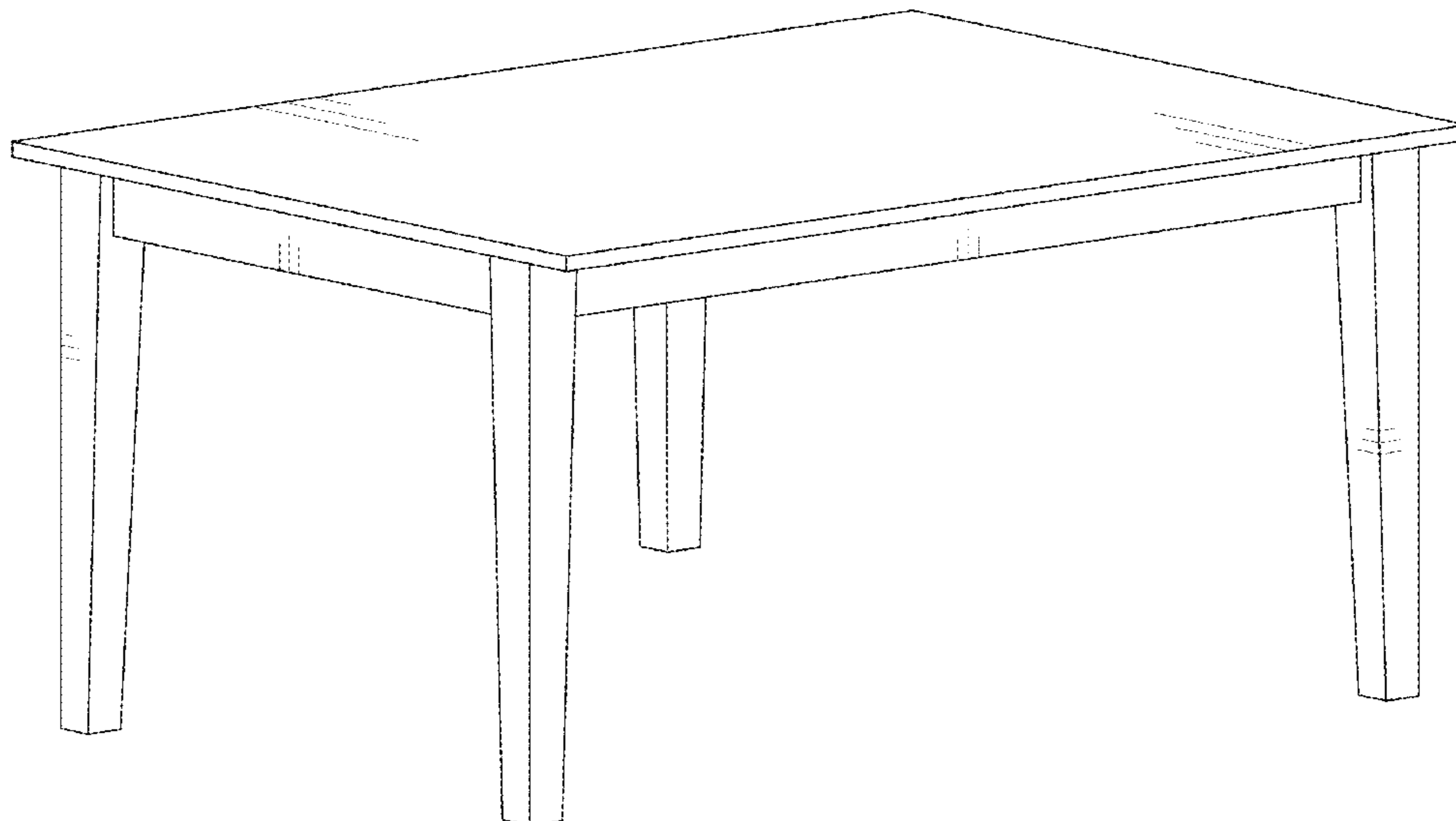

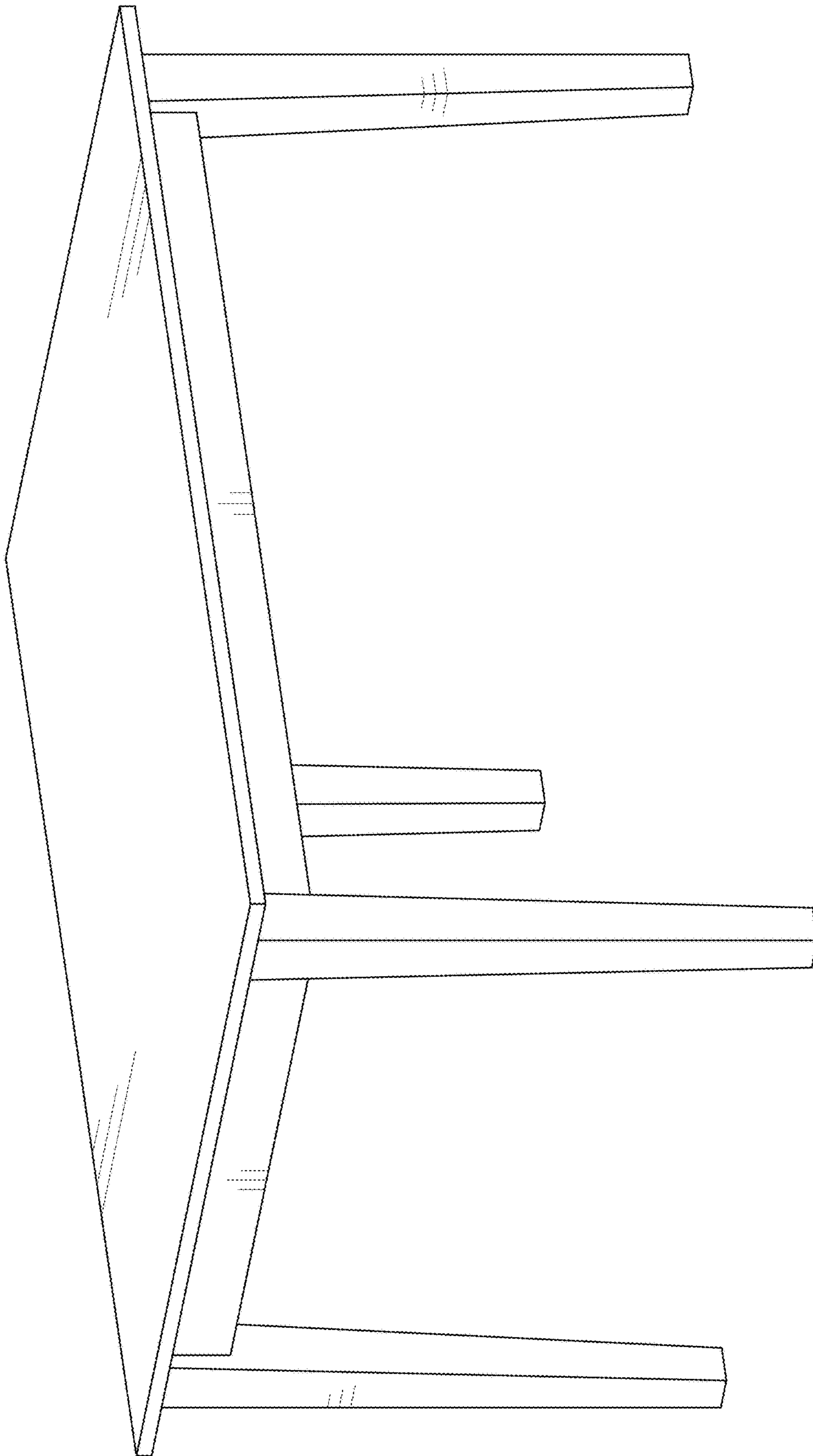

FIG. 1

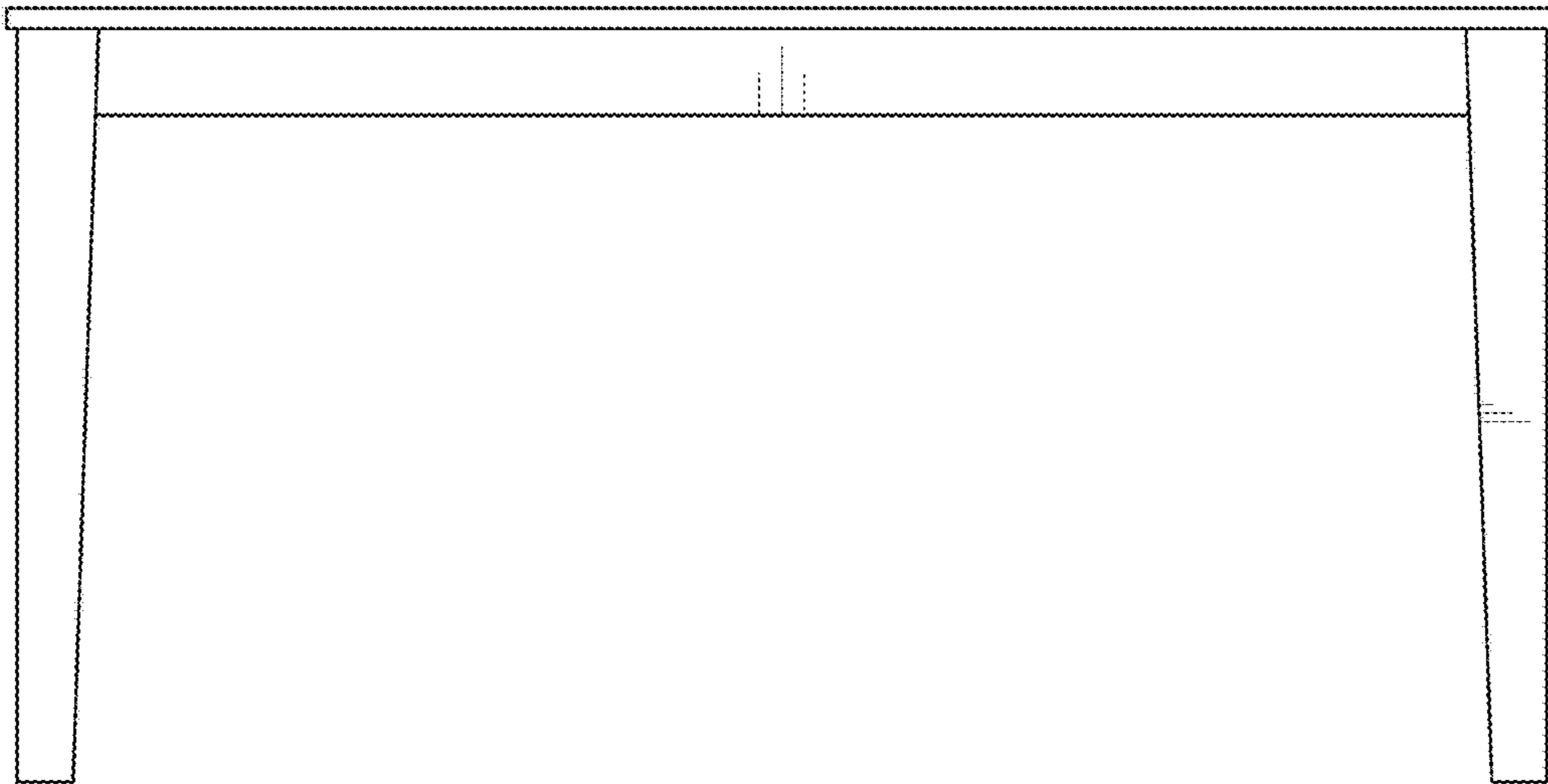

FIG. 2

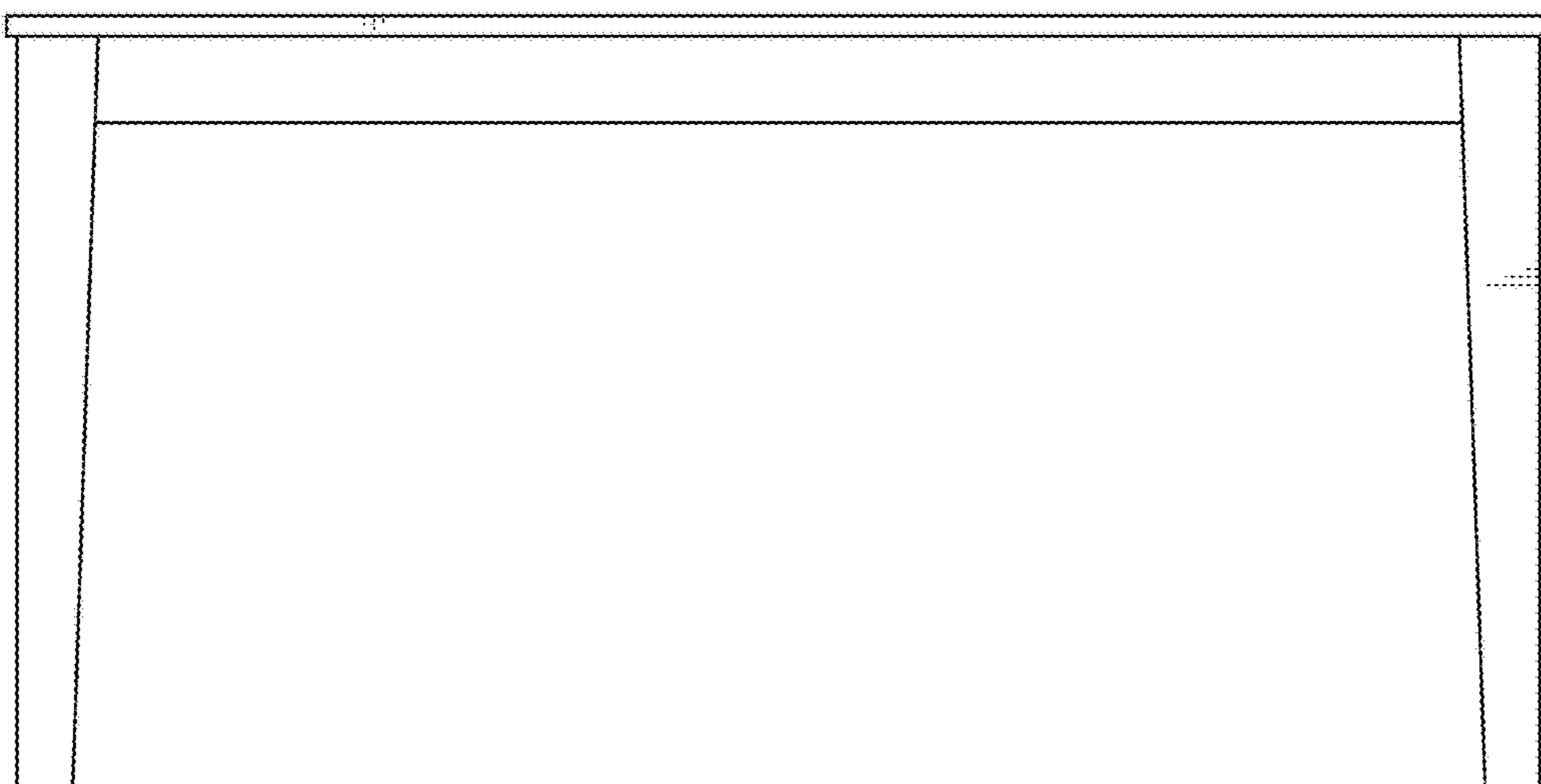

FIG. 3

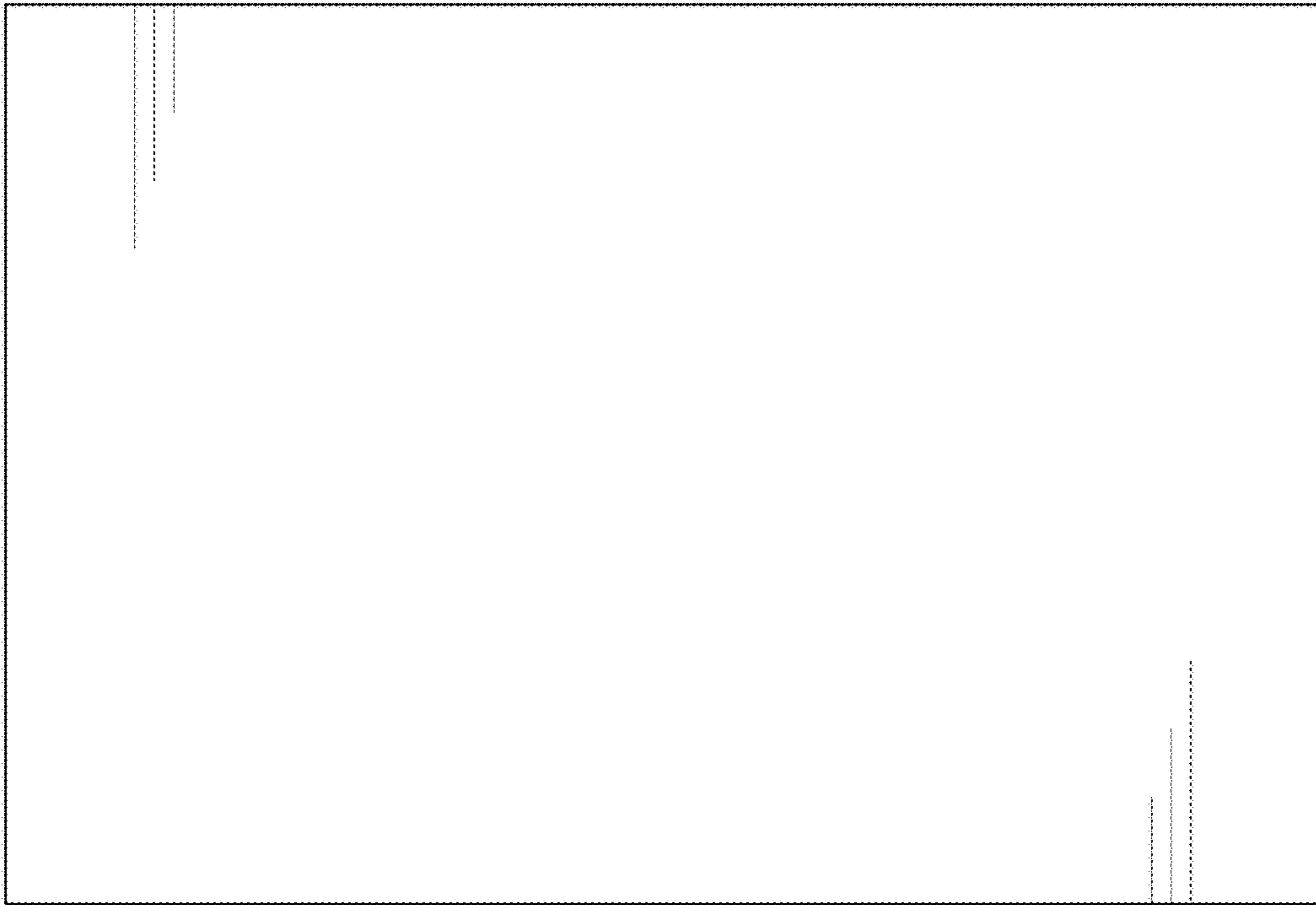

FIG. 4

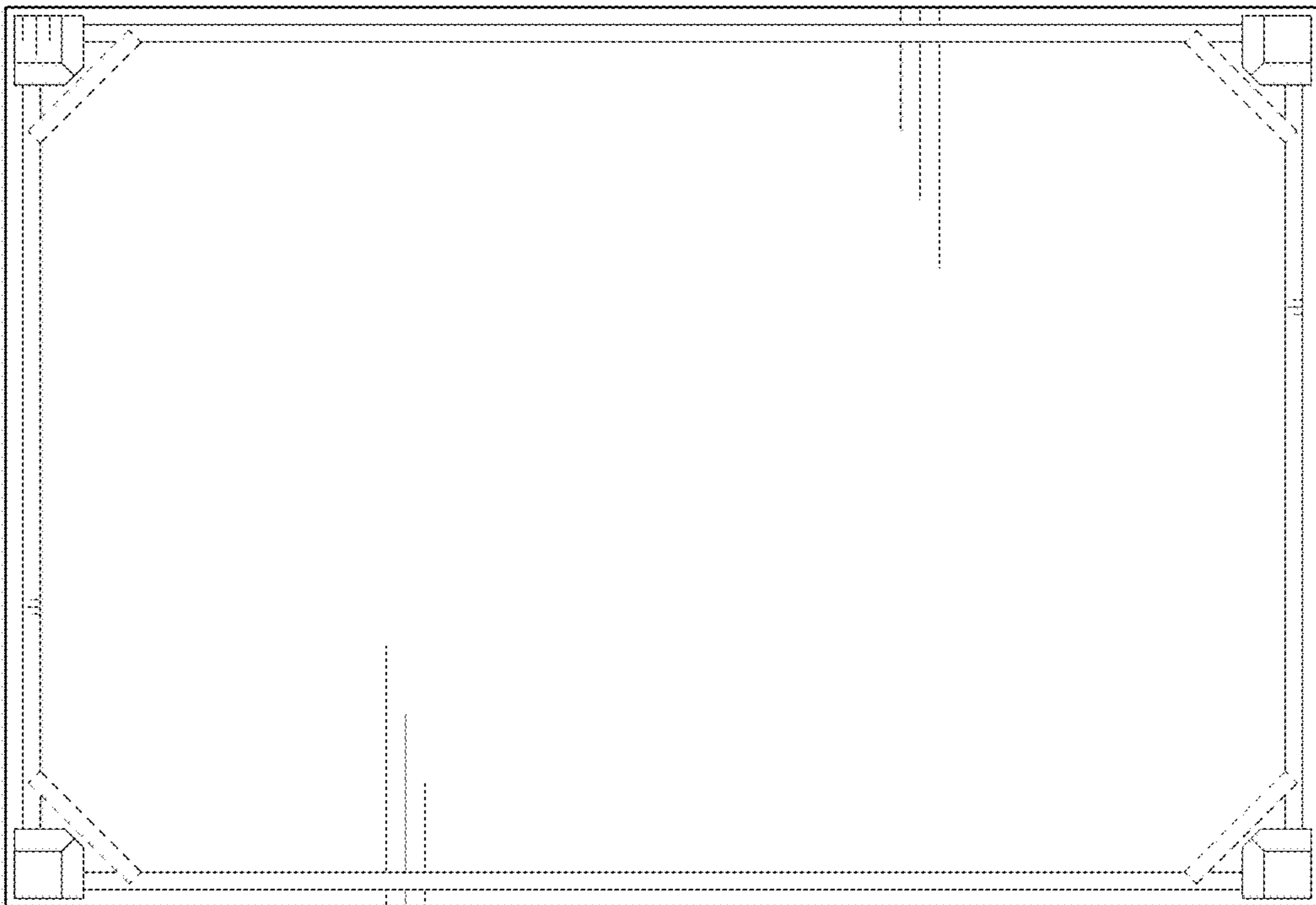
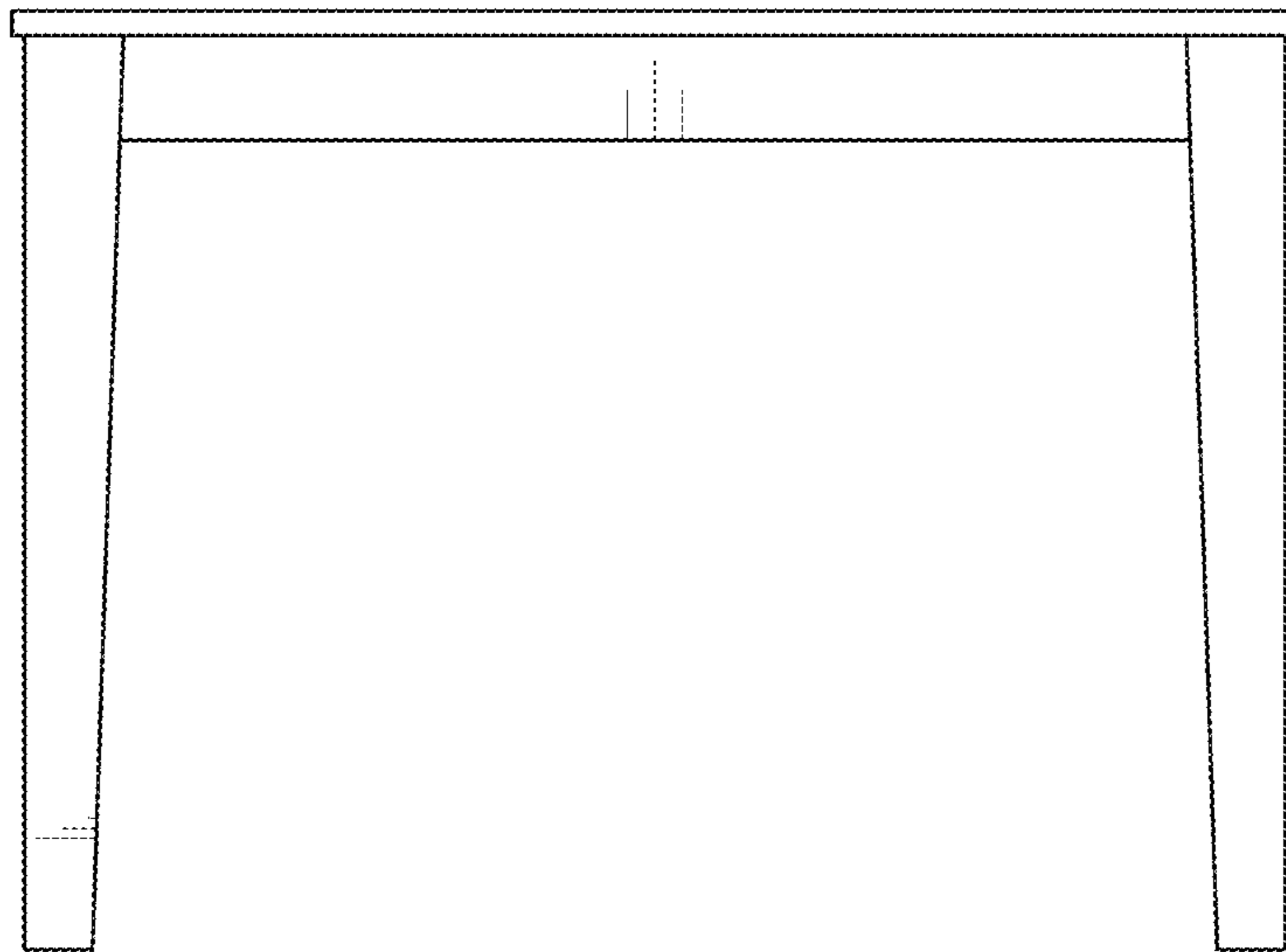
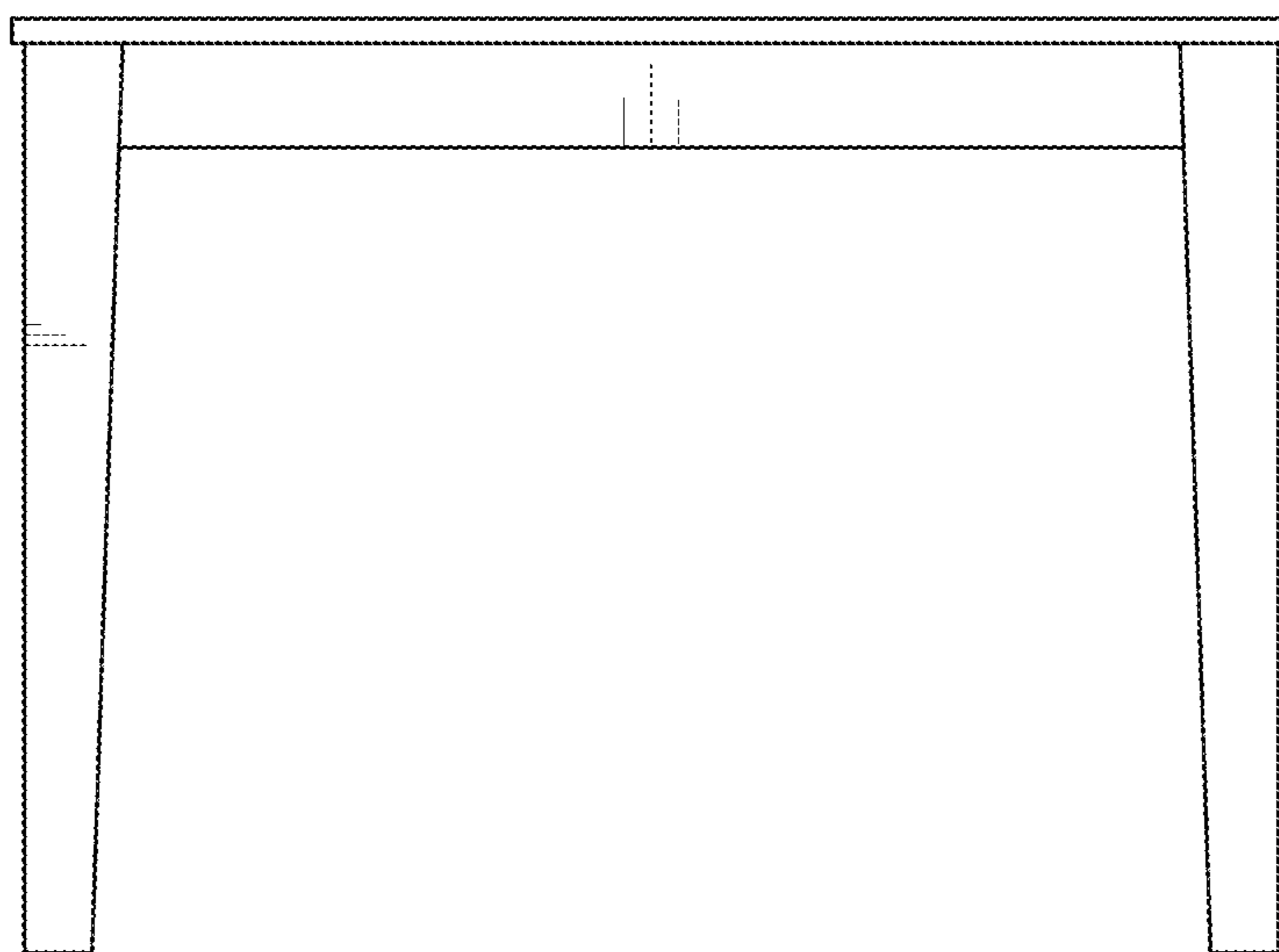

FIG. 5



**FIG. 6**



**FIG. 7**