



US00D829471S

(12) **United States Design Patent** (10) **Patent No.:** **US D829,471 S**
Fortmann et al. (45) **Date of Patent:** **** Oct. 2, 2018**

(54) **KITCHEN GARDEN CABINET**
(71) Applicant: **Carter-Hoffmann LLC**, Mundelein, IL (US)
(72) Inventors: **Robert C. Fortmann**, Grayslake, IL (US); **Frank G. Marolda**, Vernon Hills, IL (US)
(73) Assignee: **Carter-Hoffmann LLC**, Mundelein, IL (US)
(**) Term: **15 Years**
(21) Appl. No.: **29/593,078**
(22) Filed: **Feb. 6, 2017**
(51) **LOC (11) Cl.** **06-04**
(52) **U.S. Cl.**
USPC **D6/661**
(58) **Field of Classification Search**
USPC D6/661, 663, 672, 673, 675; D23/286; D24/227; D7/601; D15/81, 84, 85, 87, D15/88, 89, 91
CPC H05K 9/0062; E05C 19/001; A47B 3/00; A47B 31/00; A47B 46/00; A47B 47/022; A47B 47/05; A47B 55/02; A47B 57/42; A47B 67/02; A47B 73/00; A47B 77/02; A47B 81/00; A47B 81/005; A47B 87/005; A47B 2031/003; A47B 2031/005; A47F 3/002; A47F 3/0434; A47F 3/0486; A47F 5/08; A45C 11/16; A47J 39/006; F25D 2400/36; G09F 1/12; G09F 2023/0033
See application file for complete search history.

Primary Examiner — Kevin K Rudzinski
Assistant Examiner — Paul D Bohannon
(74) *Attorney, Agent, or Firm* — Brinks Gilson & Lione

(57) **CLAIM**

The ornamental design for a kitchen garden cabinet, as shown and described.

DESCRIPTION

FIG. 1 is a perspective view of an embodiment of a kitchen garden cabinet with two transparent or translucent front portions ;
FIG. 2 is a front elevation thereof;
FIG. 3 is a right side elevation thereof;
FIG. 4 is a left side elevation view thereof;
FIG. 5 is a top plan view thereof;
FIG. 6 is a bottom plan view thereof; and
FIG. 7 is a bottom perspective view thereof.
FIG. 8 is a perspective view of another embodiment of a kitchen garden cabinet with two transparent or translucent front portions;
FIG. 9 is a front elevation thereof;
FIG. 10 is a right side elevation thereof;
FIG. 11 is a left side elevation view thereof;
FIG. 12 is a top plan view thereof;
FIG. 13 is a bottom plan view thereof; and
FIG. 14 is a bottom perspective view thereof.
FIG. 15 is a perspective view of another embodiment of a kitchen garden cabinet with two transparent or translucent front portions;
FIG. 16 is a front elevation thereof;
FIG. 17 is a right side elevation thereof;
FIG. 18 is a left side elevation view thereof;
FIG. 19 is a top plan view thereof;
FIG. 20 is a bottom plan view thereof; and,
FIG. 21 is a bottom perspective view thereof.
Broken lines in the drawings are for the purpose of illustrating portions of the article that form no part of the claimed design. No claim is made to the rear view/ back side views of any embodiment, none of which are illustrated herein.

(56) **References Cited**

U.S. PATENT DOCUMENTS

D186,448 S * 10/1959 Powell et al. D15/85
3,106,801 A 10/1963 Risacher

(Continued)

1 Claim, 15 Drawing Sheets

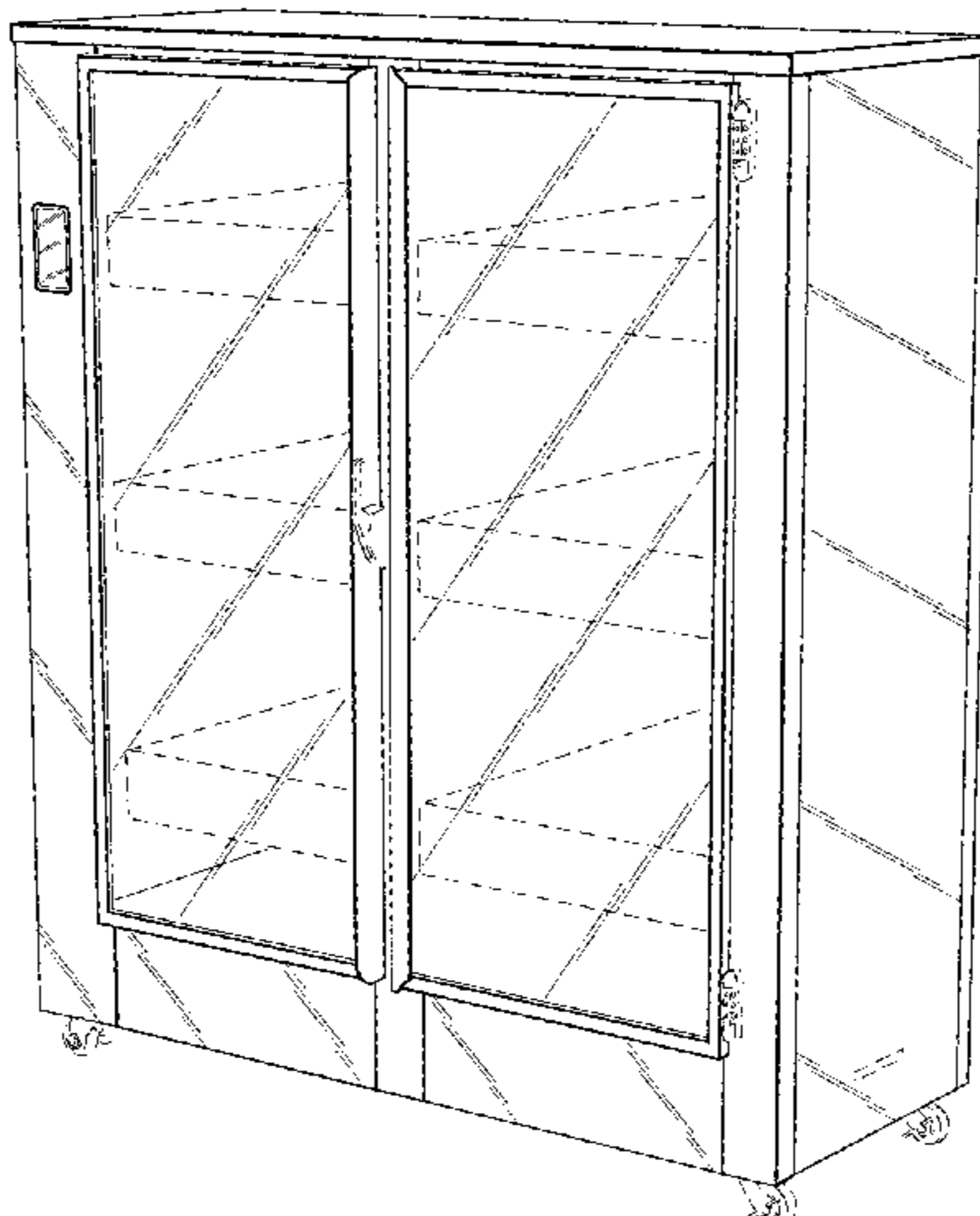

(56)

References Cited

U.S. PATENT DOCUMENTS

D243,985 S *	4/1977	Brown	D15/85	D743,452 S *	11/2015	Zubieta	D15/79
4,244,145 A	1/1981	Polacsek		9,243,789 B1	1/2016	Chow	
4,291,494 A	9/1981	Knablein		9,265,205 B2	2/2016	Cheng et al.	
D265,316 S *	7/1982	Trulaske	D15/85	D755,259 S *	5/2016	Rautavuori	D15/79
D273,298 S *	4/1984	Trulaske	D15/81	D757,127 S *	5/2016	Rautavuori	D15/79
4,543,744 A	10/1985	Royster		9,345,201 B2	5/2016	Sakura et al.	
5,251,399 A	10/1993	Rasmussen		9,357,715 B2	6/2016	Cottrell	
5,283,974 A	2/1994	Graf, Jr.		9,357,718 B1	6/2016	Lehman	
5,295,593 A *	3/1994	Sturm	A47F 7/288 206/429	D788,185 S *	5/2017	Wolfe	D15/79
5,430,972 A	7/1995	Wianecki		2002/0184820 A1	12/2002	Mauney	
D364,053 S *	11/1995	Hayashi	D6/661	2005/0246954 A1	11/2005	Bissonnette et al.	
D365,110 S *	12/1995	Klein, III	D15/135	2005/0246955 A1	11/2005	Bissonnette et al.	
D366,578 S *	1/1996	Cormican	D6/661	2005/0257424 A1	11/2005	Bissonnette et al.	
5,555,676 A	9/1996	Lund		2006/0179711 A1	8/2006	Bissonnette et al.	
D377,800 S *	2/1997	Branz	D15/85	2006/0254138 A1	11/2006	Bissonnette et al.	
D416,713 S *	11/1999	Trulaske, Sr.	D15/91	2006/0272210 A1	12/2006	Bissonnette et al.	
D420,368 S *	2/2000	Bardin	D15/91	2007/0271841 A1	11/2007	Bissonnette et al.	
6,233,870 B1	5/2001	Horibata		2008/0078118 A1	4/2008	Bissonnette et al.	
D449,843 S *	10/2001	Kim	D15/81	2008/0155894 A1	7/2008	Bissonnette et al.	
6,536,157 B2	3/2003	Wijbenga		2008/0222949 A1	9/2008	Bissonnette et al.	
6,725,598 B2	4/2004	Yoneda et al.		2008/0276534 A1	11/2008	Bissonnette et al.	
6,748,696 B1	6/2004	Davidson		2008/0282610 A1	11/2008	Bissonnette et al.	
D524,830 S *	7/2006	Lei	D15/81	2009/0025287 A1	1/2009	Lee	
D550,256 S *	9/2007	Lei	D15/81	2010/0088953 A1	4/2010	Oosterling	
7,516,574 B2	4/2009	Gottlieb		2010/0275512 A1	11/2010	Nien	
7,617,057 B2	11/2009	May et al.		2011/0219683 A1	9/2011	Sutton	
D627,374 S *	11/2010	Yang	D15/81	2011/0252705 A1	10/2011	Van Gemert et al.	
7,823,324 B2	11/2010	Townsley		2012/0042568 A1	2/2012	Keith	
7,975,428 B2	7/2011	Townsley		2012/0167460 A1	7/2012	Omidi	
7,987,632 B2	8/2011	May et al.		2013/0063326 A1 *	3/2013	Riegel	G09F 9/33 345/4
D659,724 S	5/2012	Wolfe		2014/0026474 A1	1/2014	Kulas	
D659,725 S	5/2012	Wolfe		2014/0053463 A1	2/2014	Khaled	
8,166,700 B2	5/2012	Townsley		2014/0144078 A1	5/2014	Gonyer	
8,181,387 B2	5/2012	Loebl et al.		2014/0208642 A1	7/2014	Henman	
8,234,812 B1	8/2012	Colless		2014/0259920 A1	9/2014	Wilson	
8,261,486 B2	9/2012	Bissonnette et al.		2015/0096225 A1	4/2015	Gervais	
8,327,580 B2	12/2012	Miyahara		2015/0237810 A1	8/2015	Van Gemert et al.	
D675,846 S *	2/2013	Monaldi	D6/661	2015/0305259 A1	10/2015	Galassi	
8,438,779 B2	5/2013	Townsley		2016/0007545 A1	1/2016	Yen et al.	
8,443,546 B1	5/2013	Darin		2016/0029574 A1	2/2016	He et al.	
8,468,741 B2	6/2013	Lewis		2016/0109107 A1	4/2016	Grajcar	
8,505,238 B2	8/2013	Luebbers		2016/0113222 A1	4/2016	Hori et al.	
8,910,419 B1	12/2014	Oberst		2016/0128288 A1	5/2016	Pettinelli et al.	
9,101,096 B1	8/2015	Lewis		2016/0157439 A1	6/2016	Greene et al.	
				2016/0183477 A1	6/2016	Kao et al.	

* cited by examiner

Fig. 1

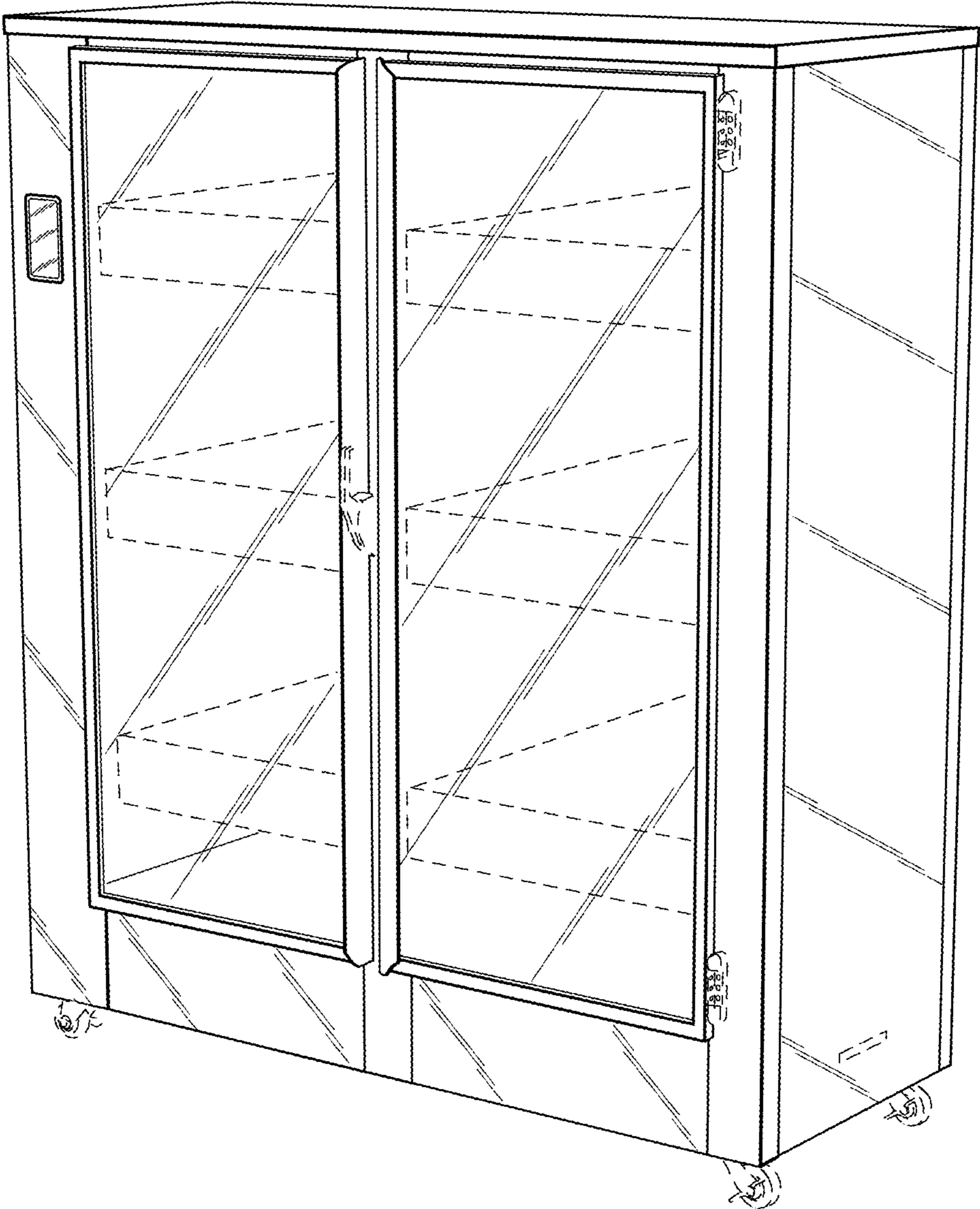

Fig. 2

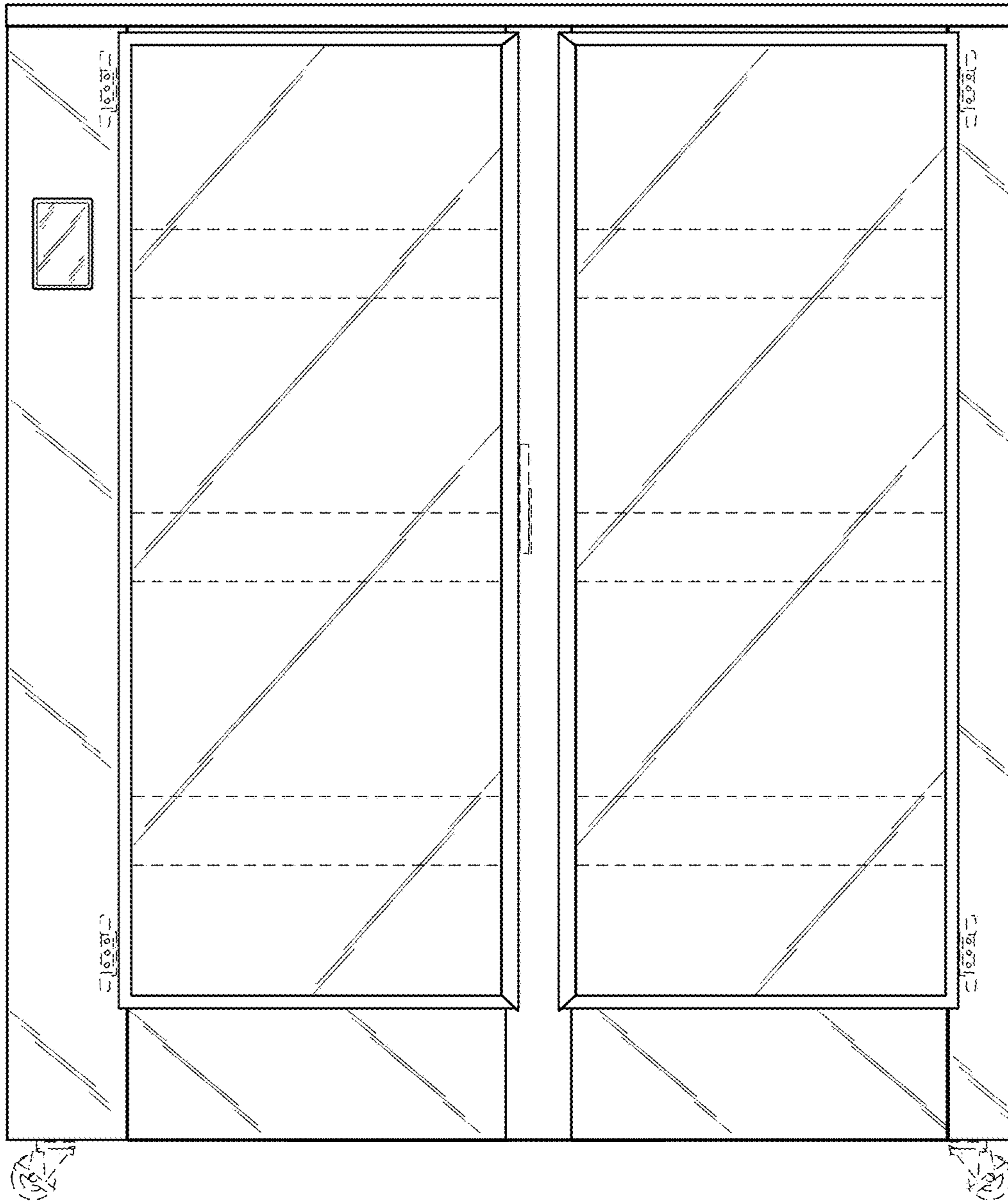

Fig. 3

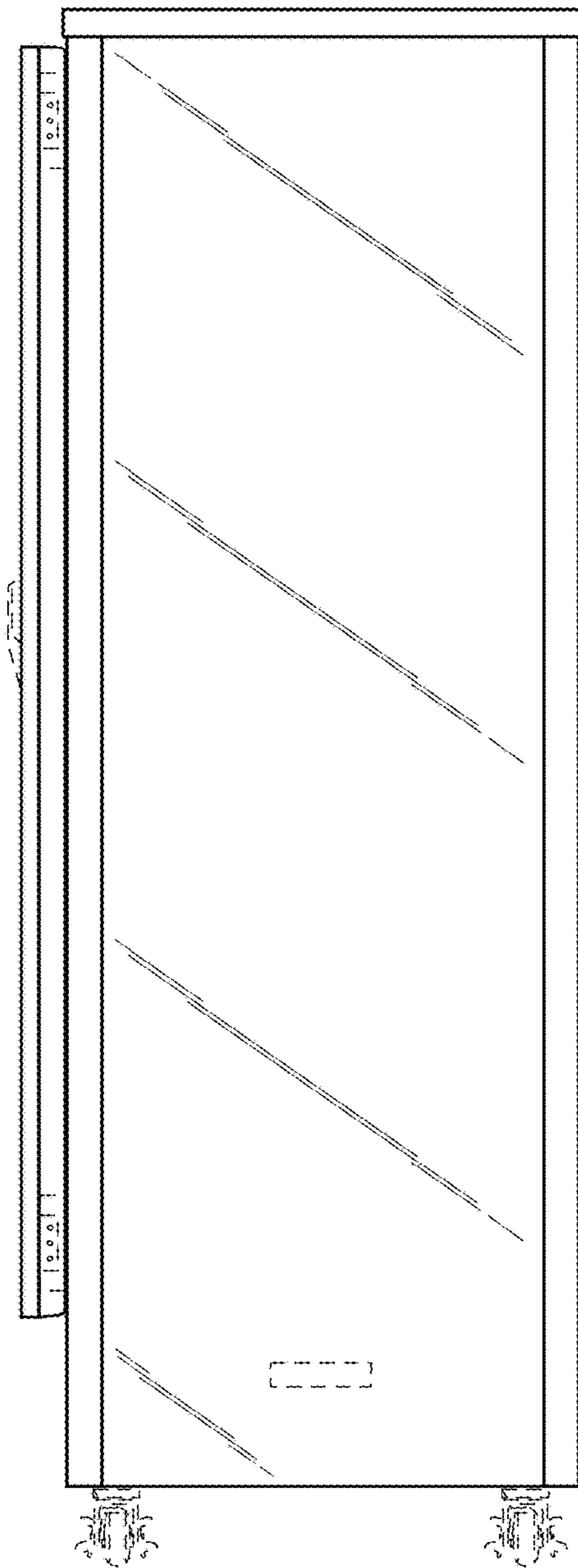

Fig. 4

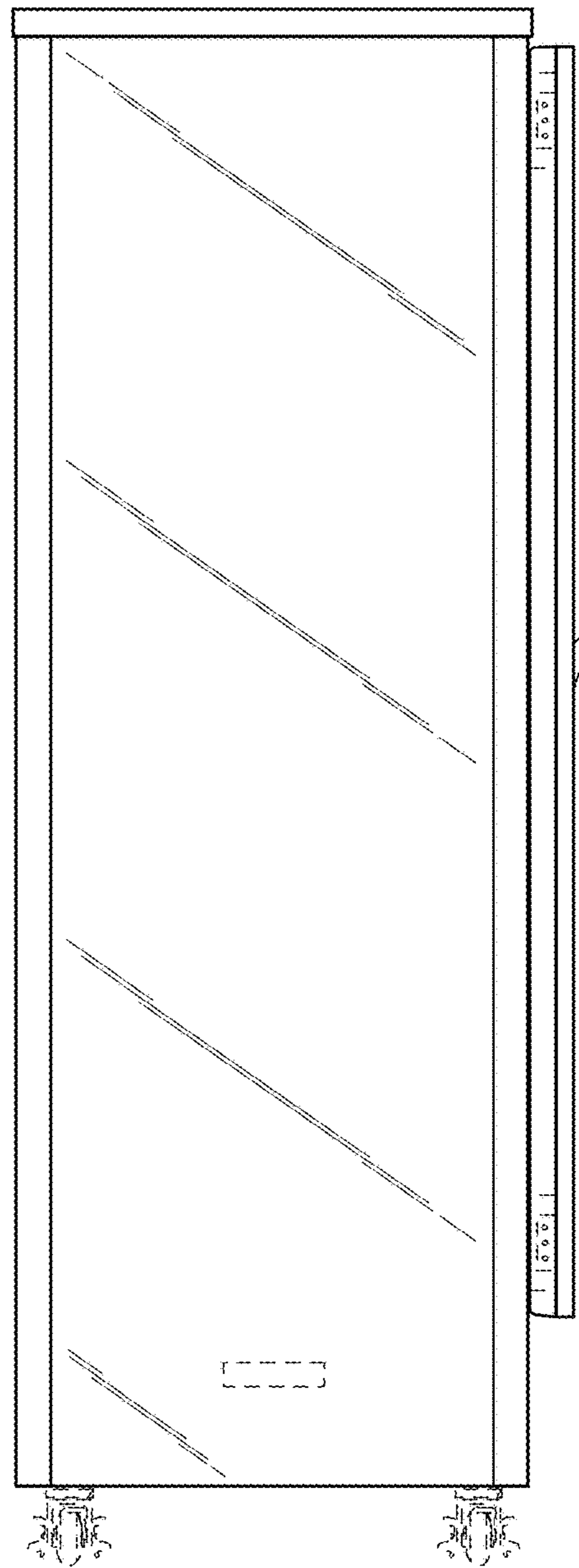

Fig. 5

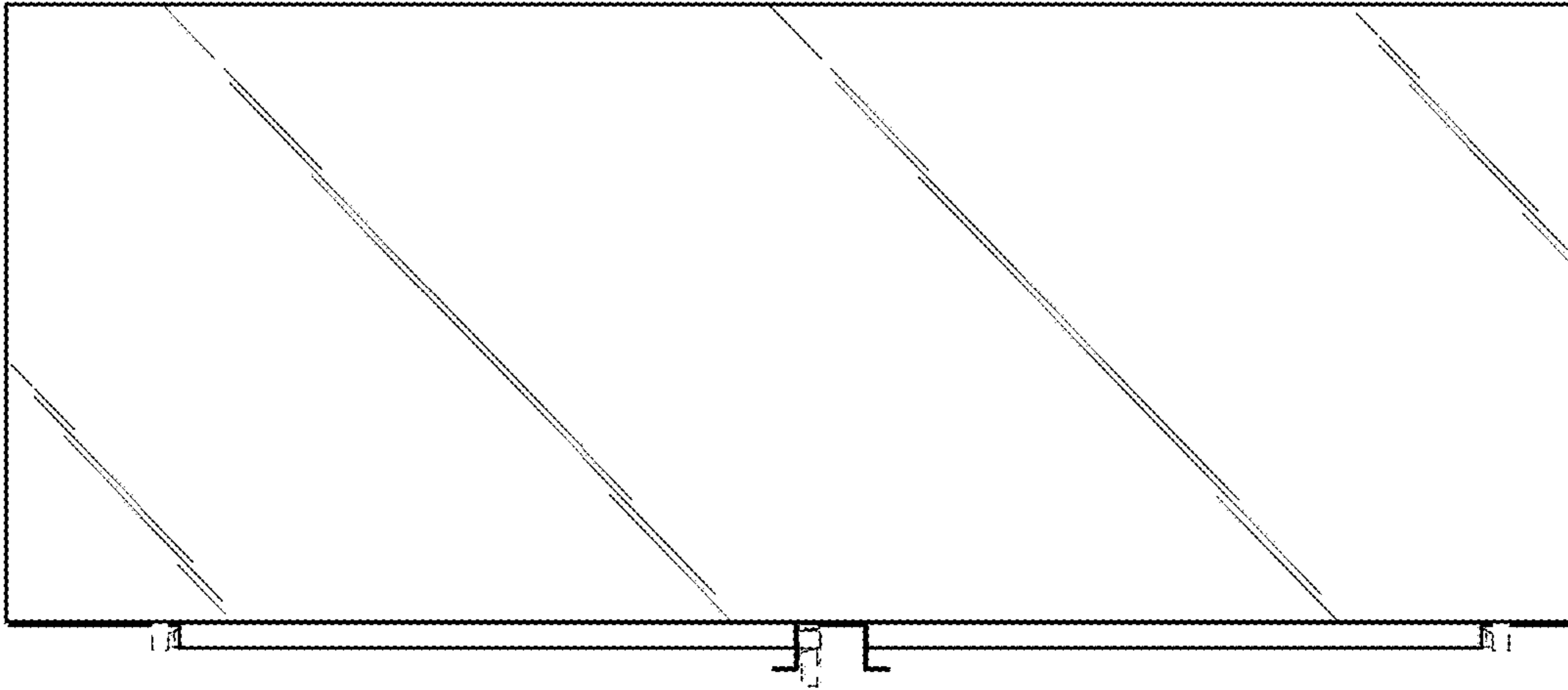

Fig. 6

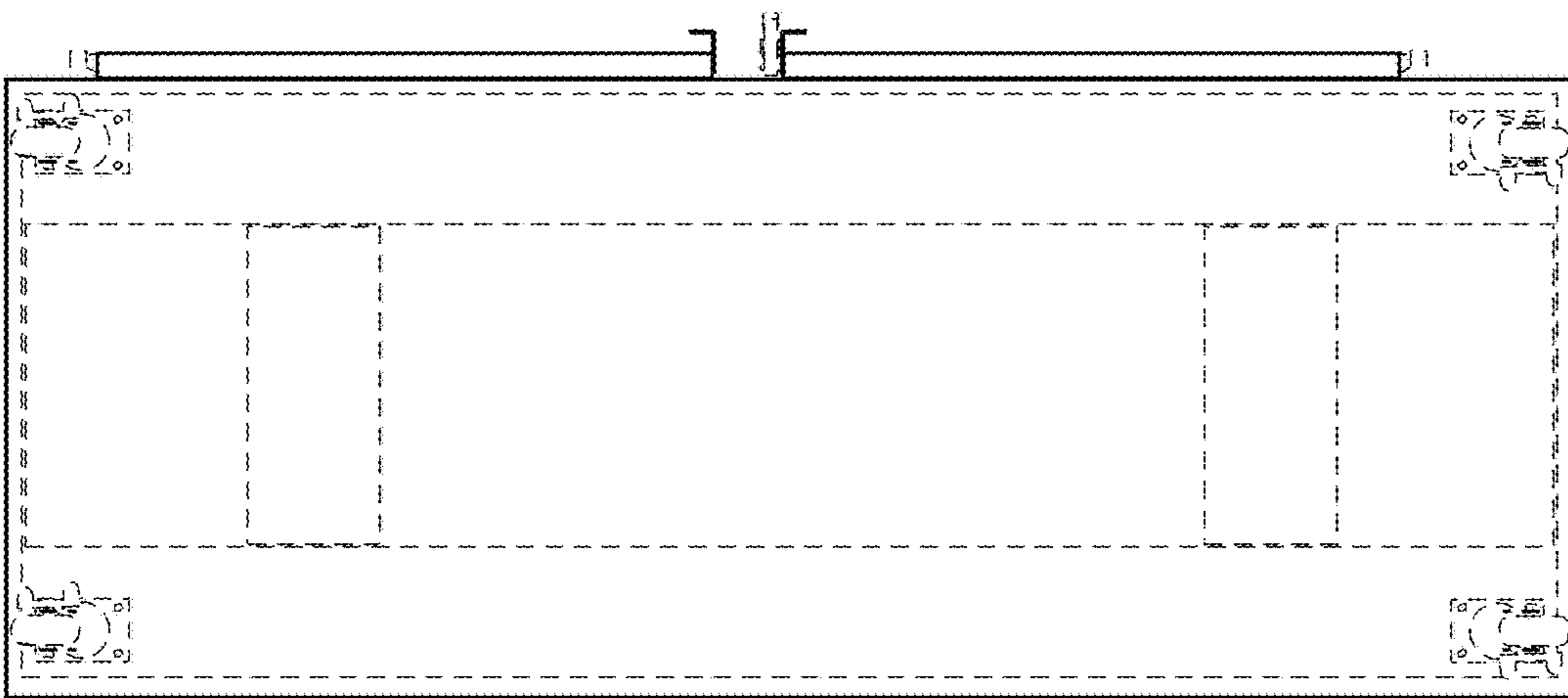

Fig. 7

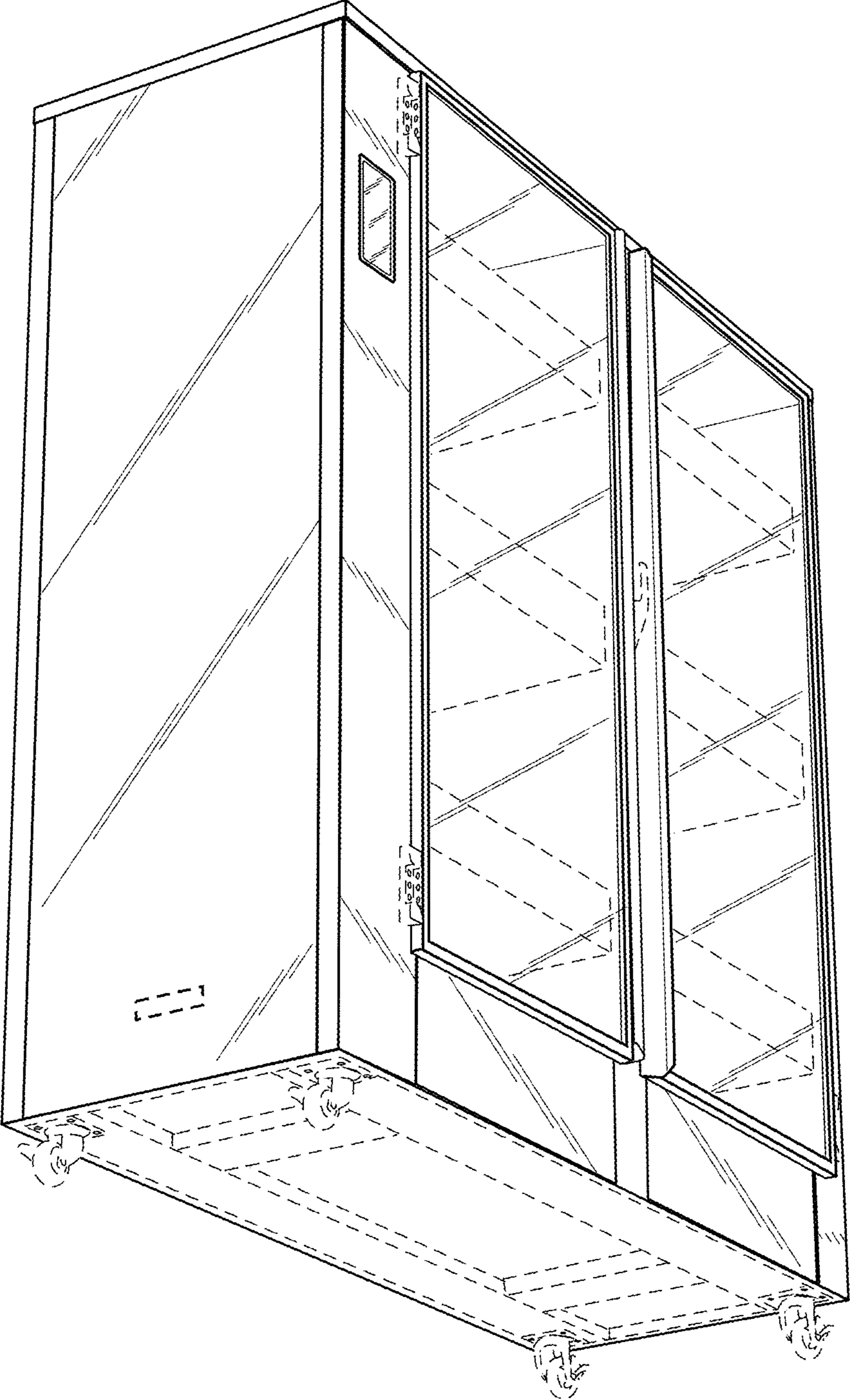

Fig. 8

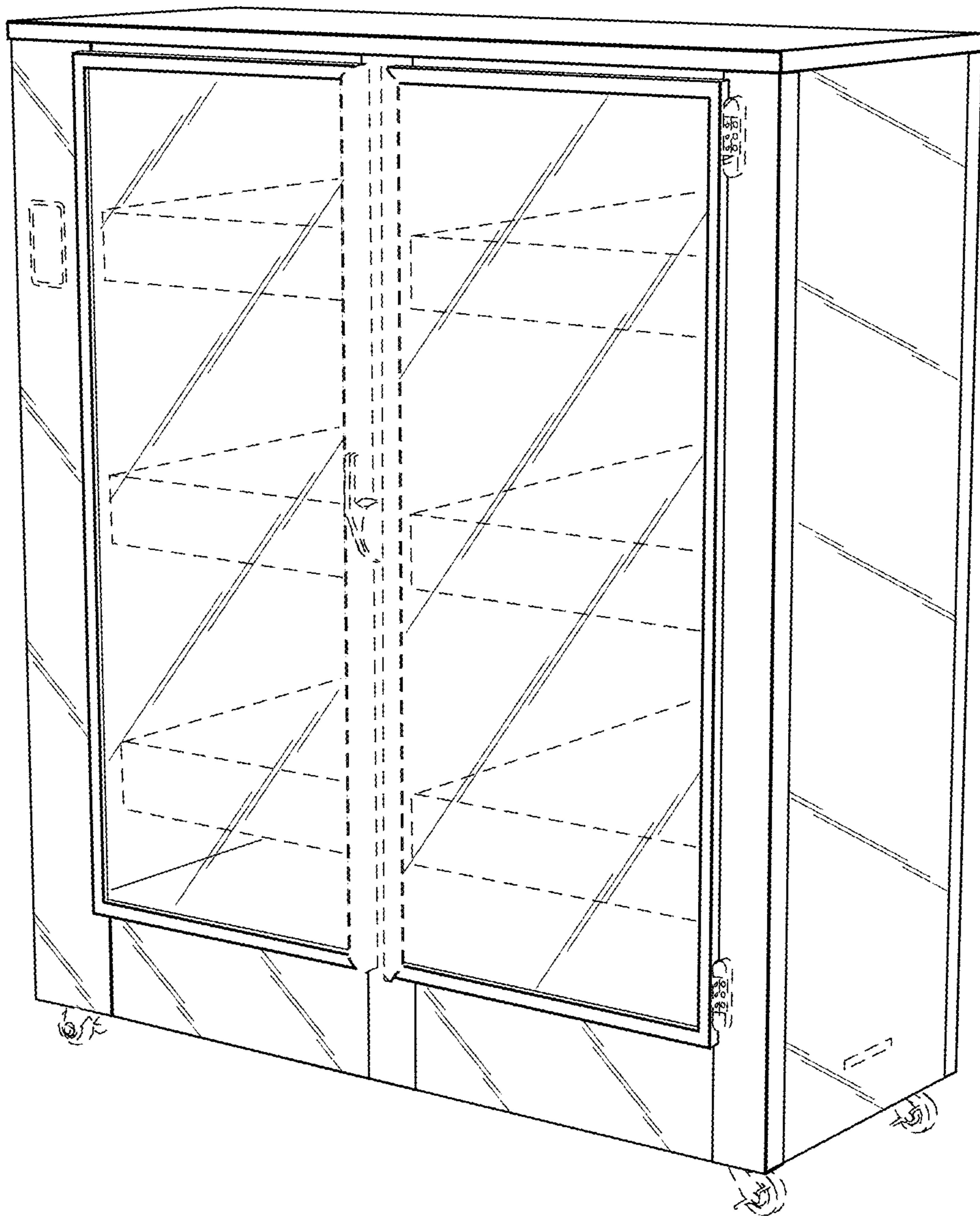

Fig. 9

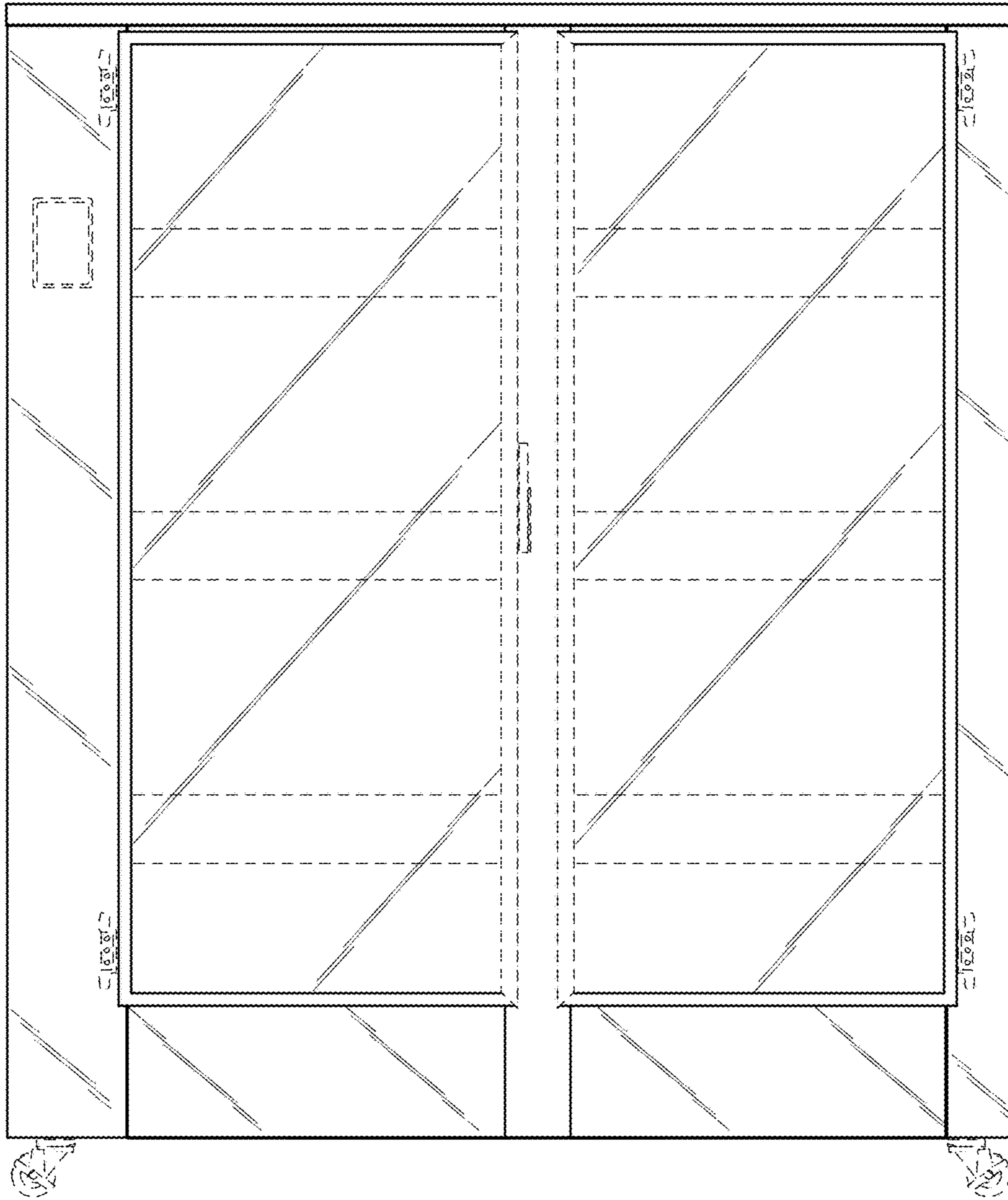

Fig. 10

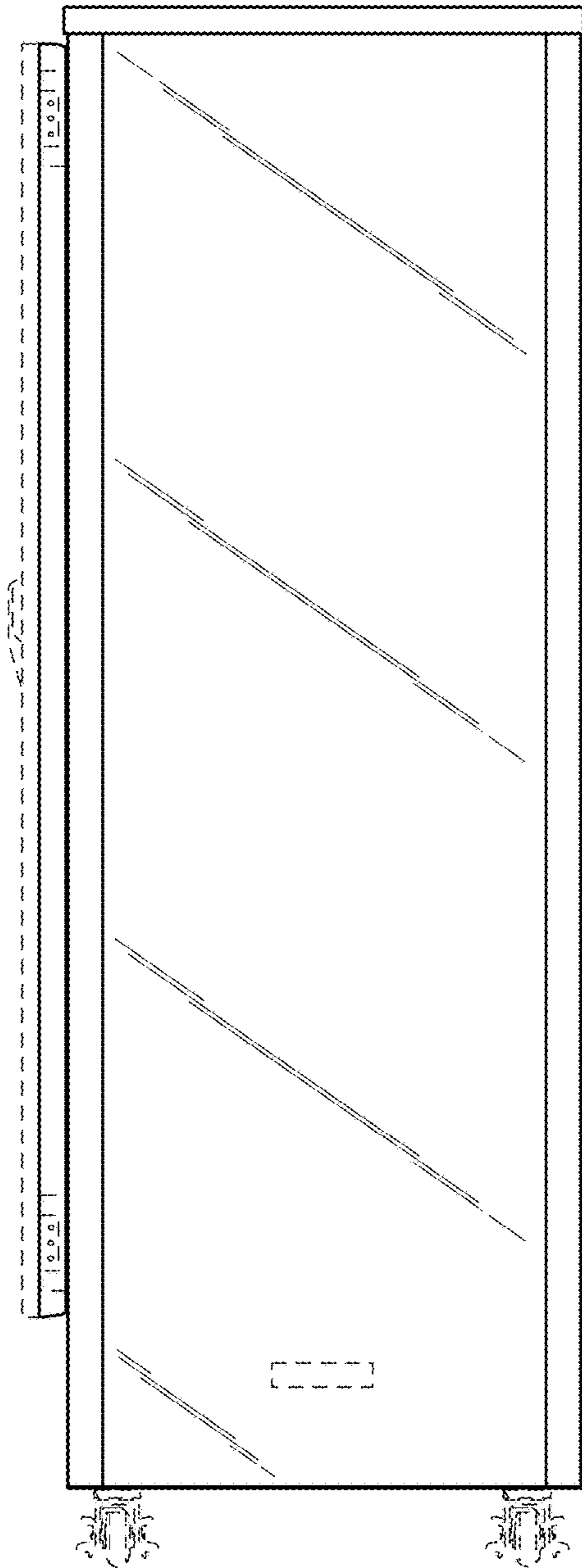

Fig. 11

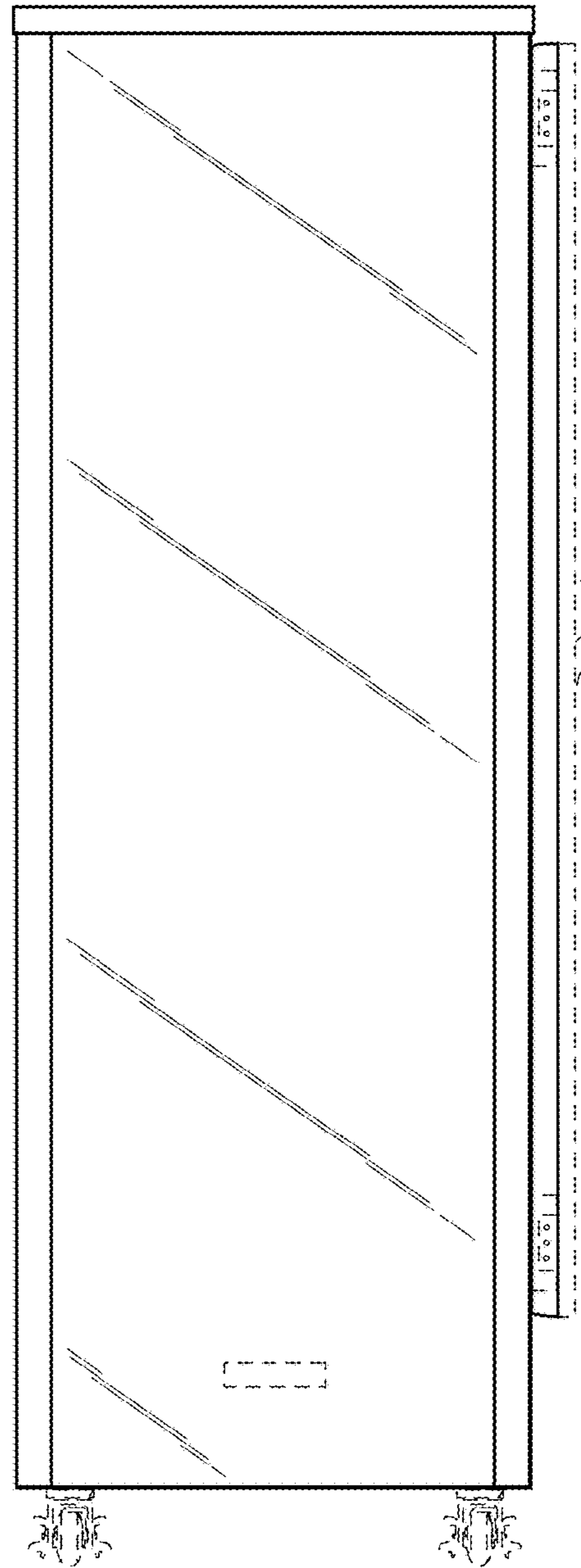

Fig. 12

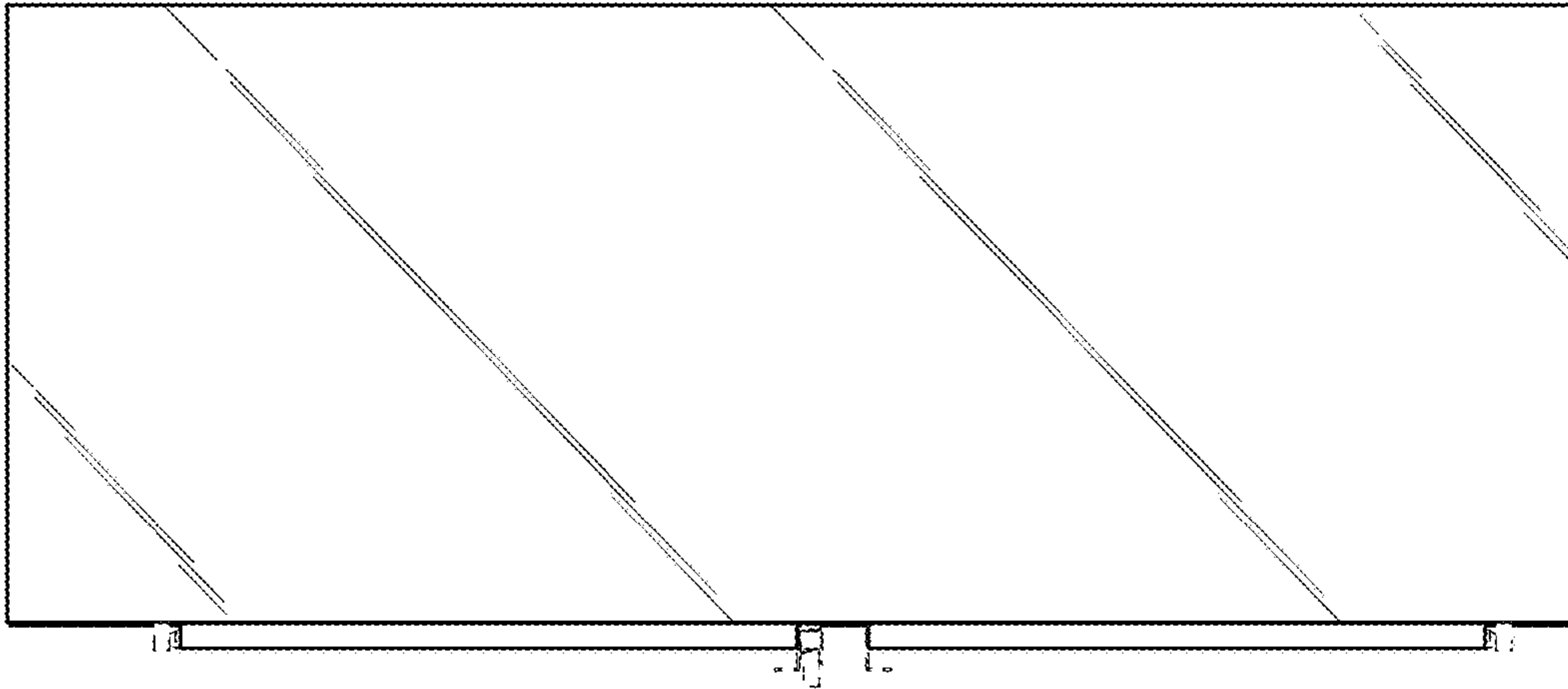

Fig. 13

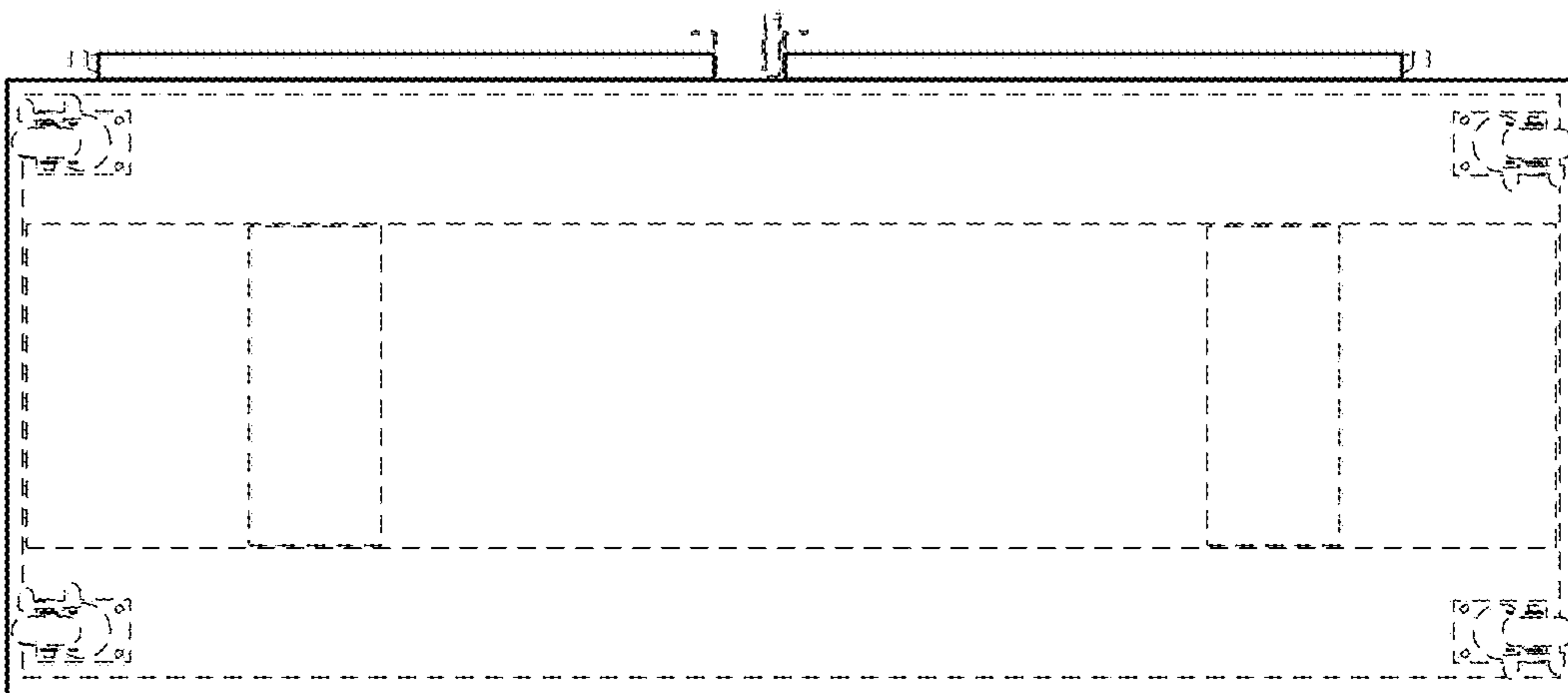

Fig. 14

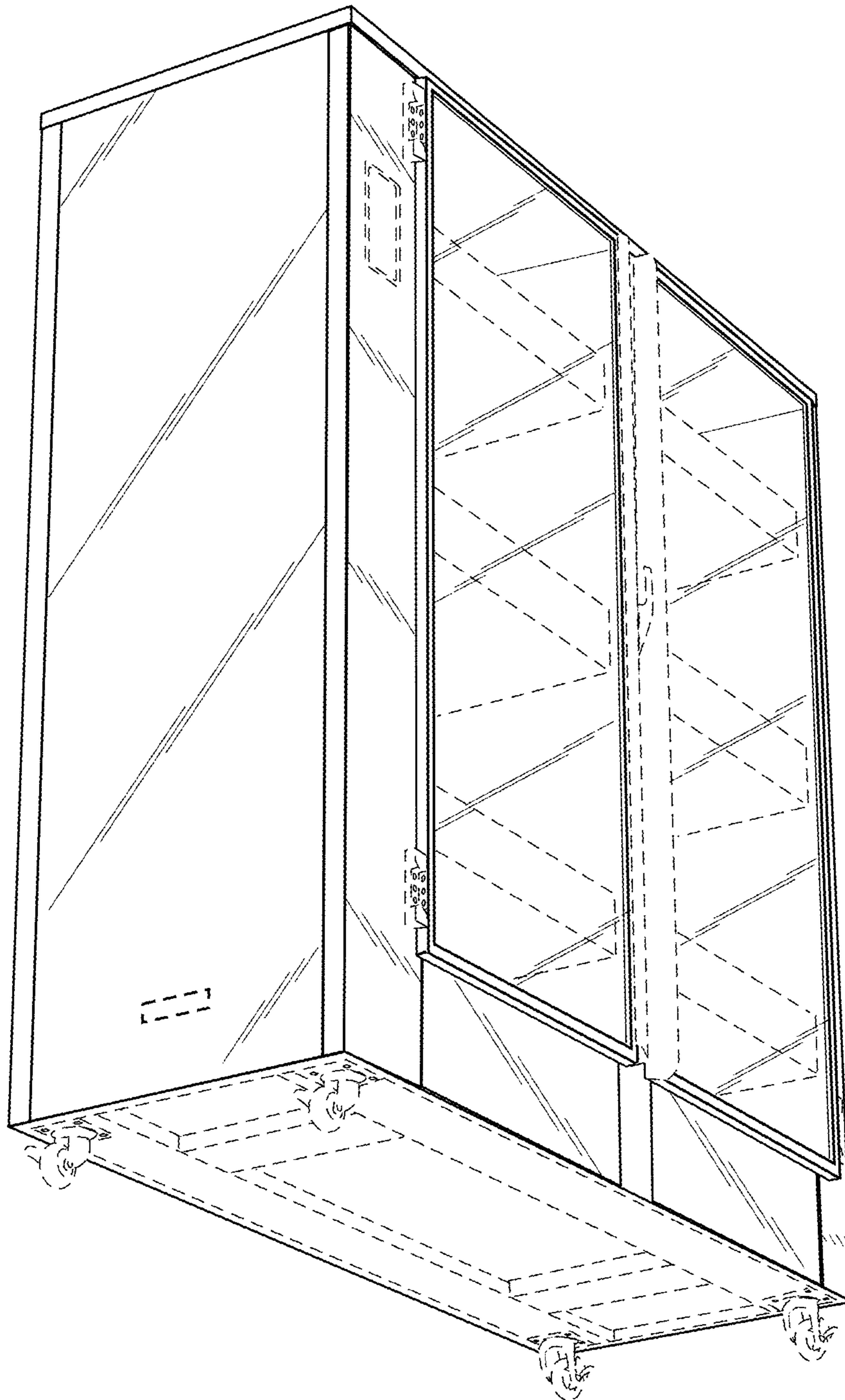

Fig. 15

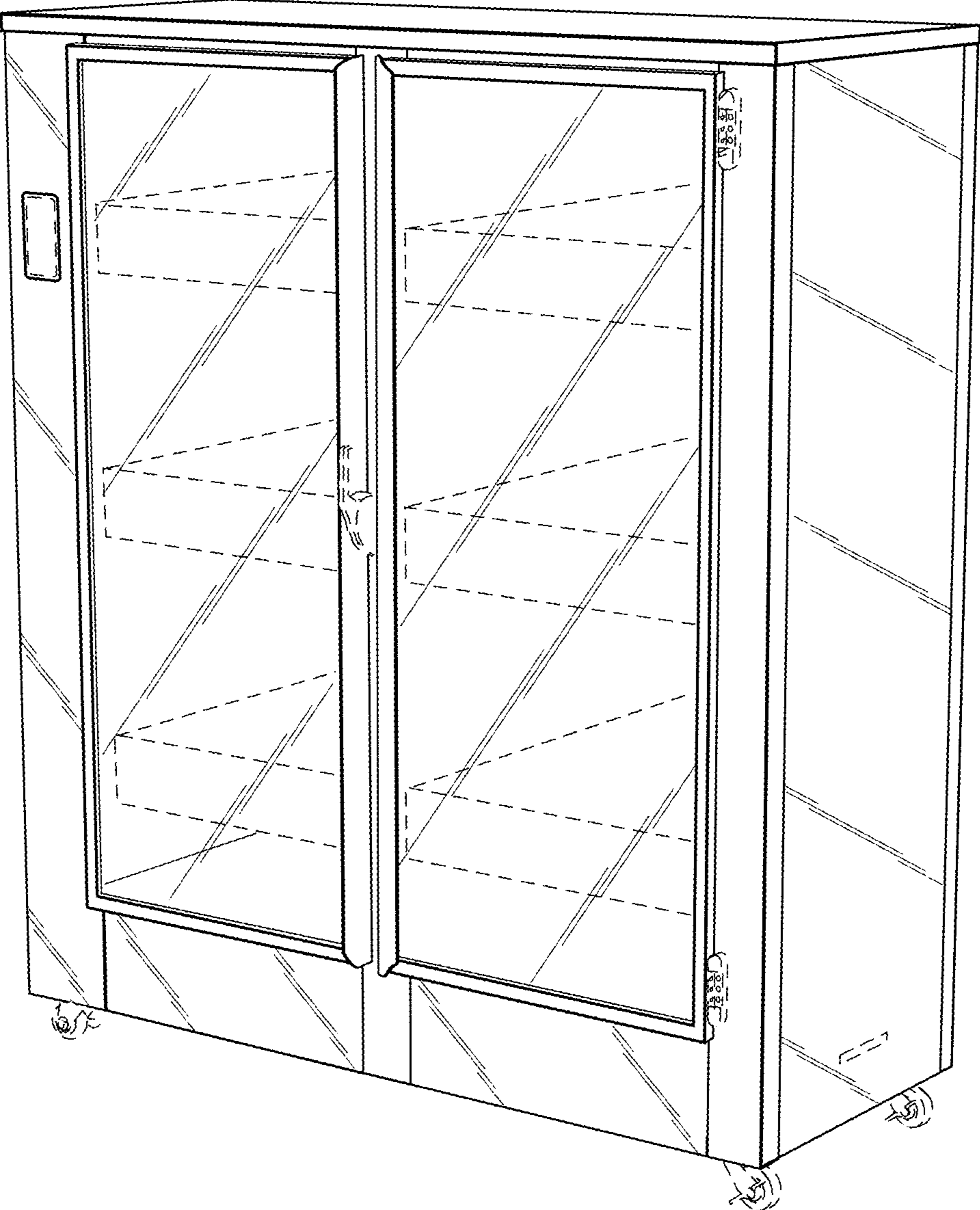

Fig. 16

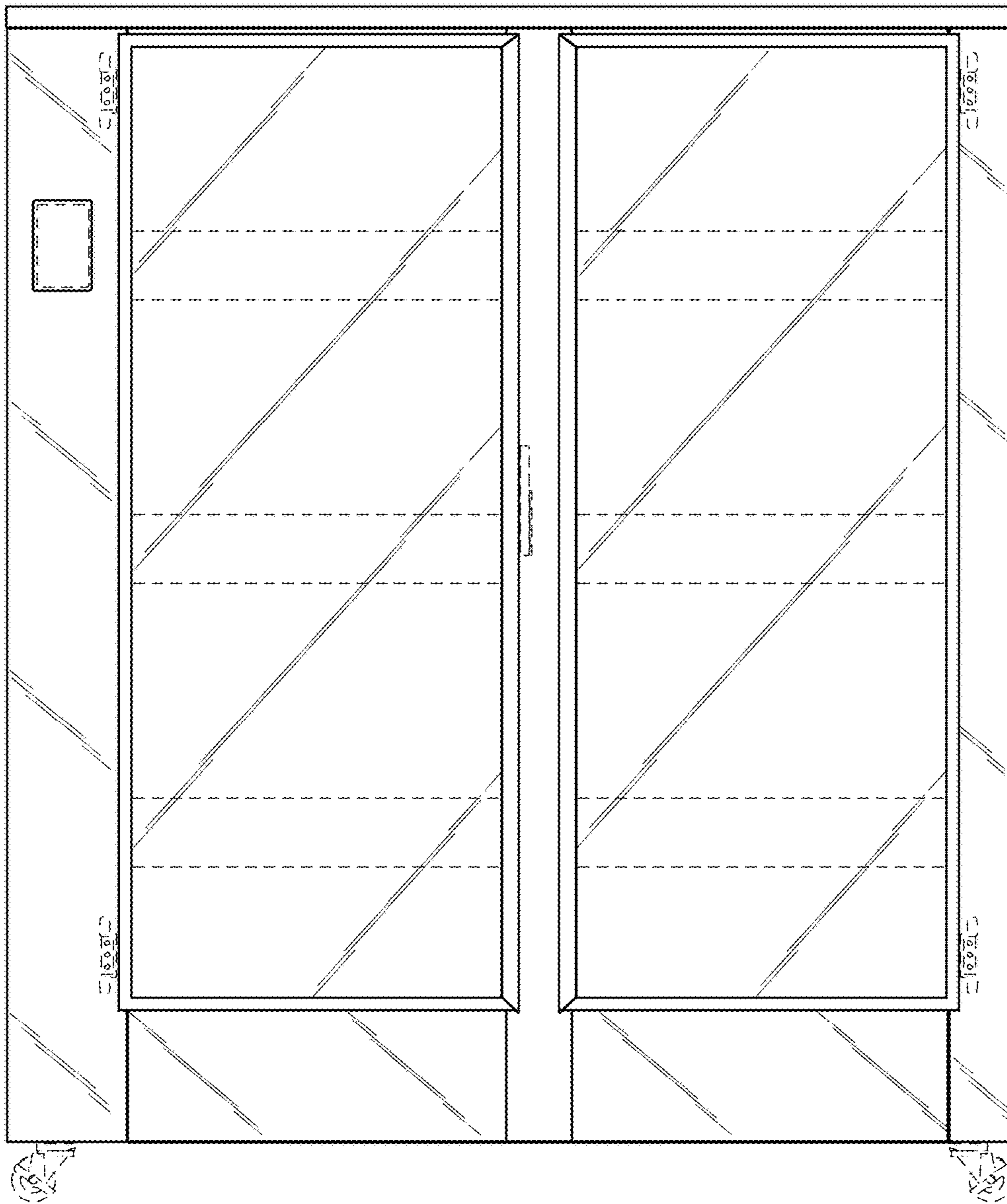

Fig. 17

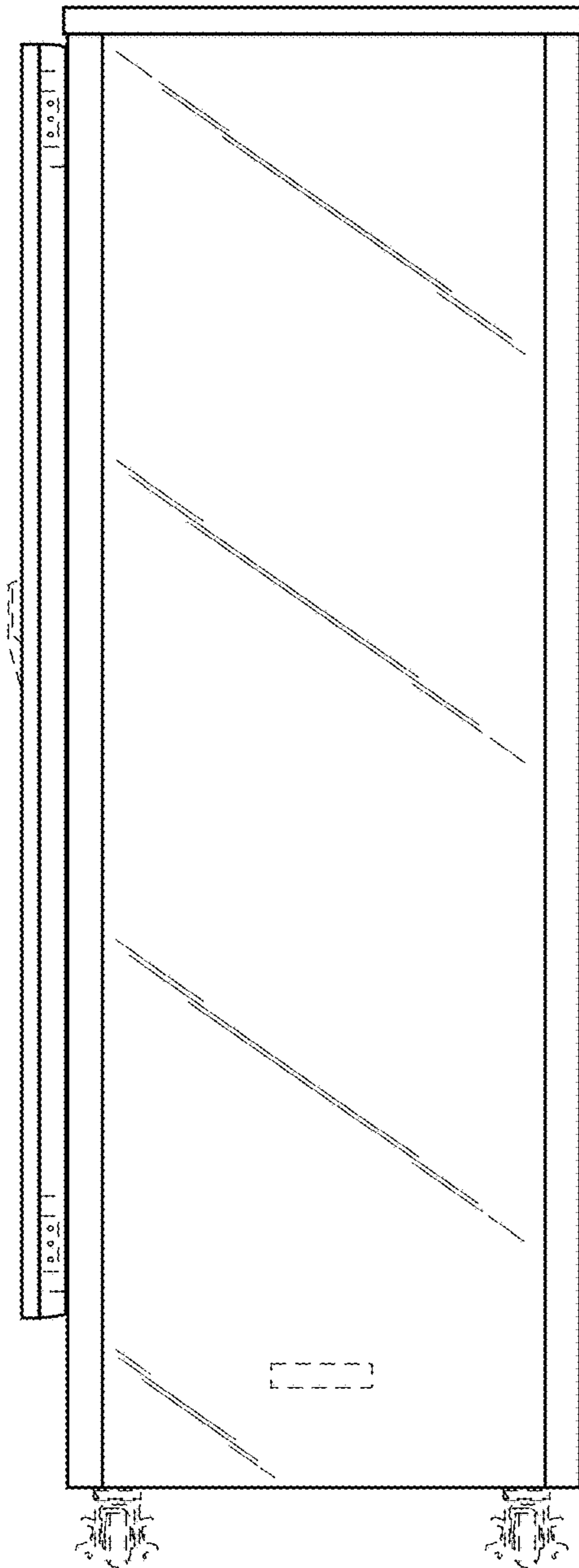

Fig. 18

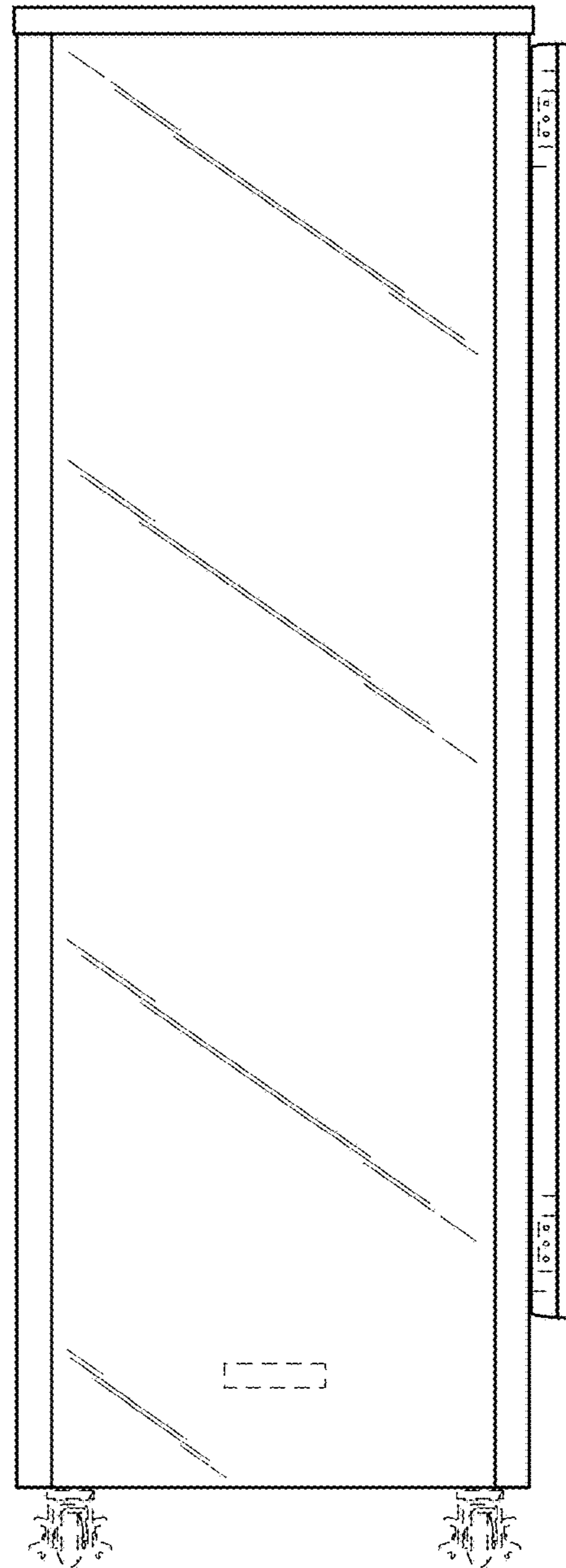

Fig. 19

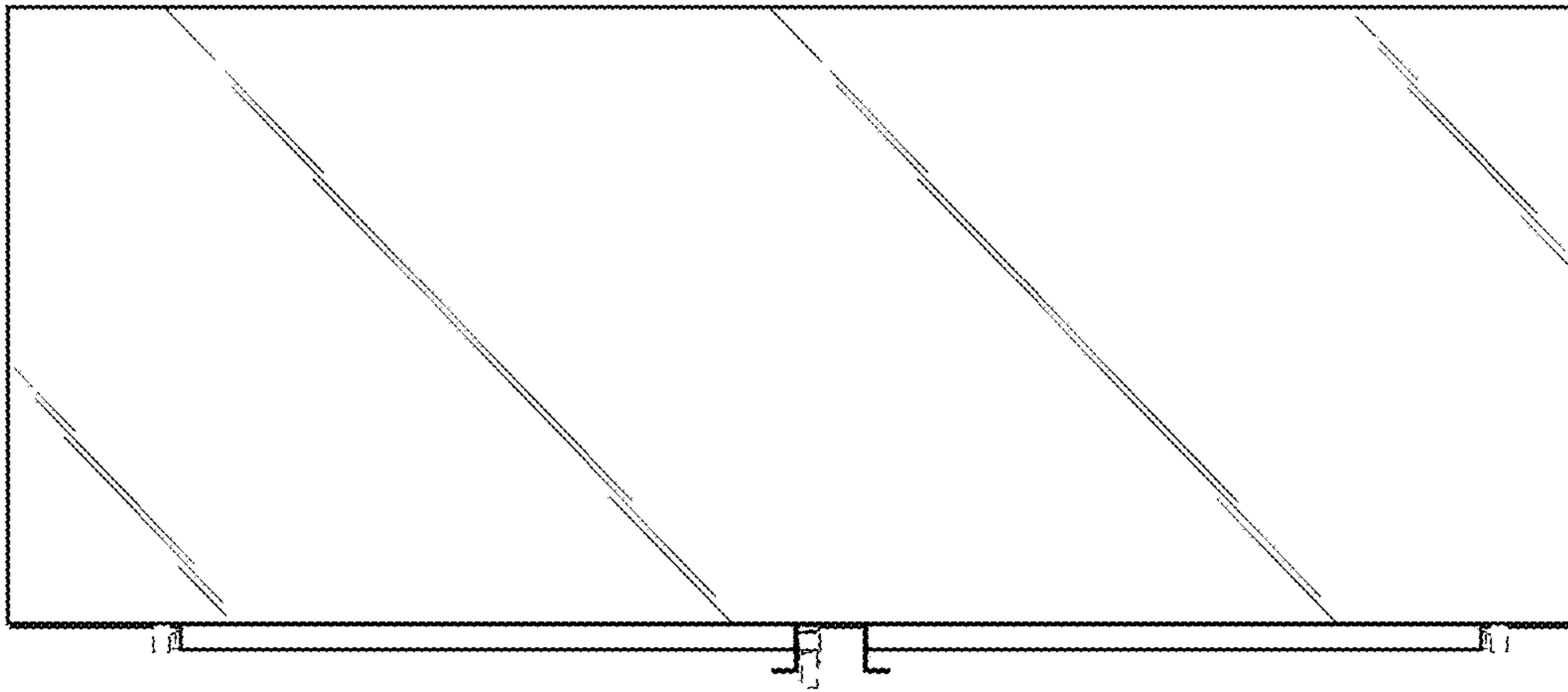

Fig. 20

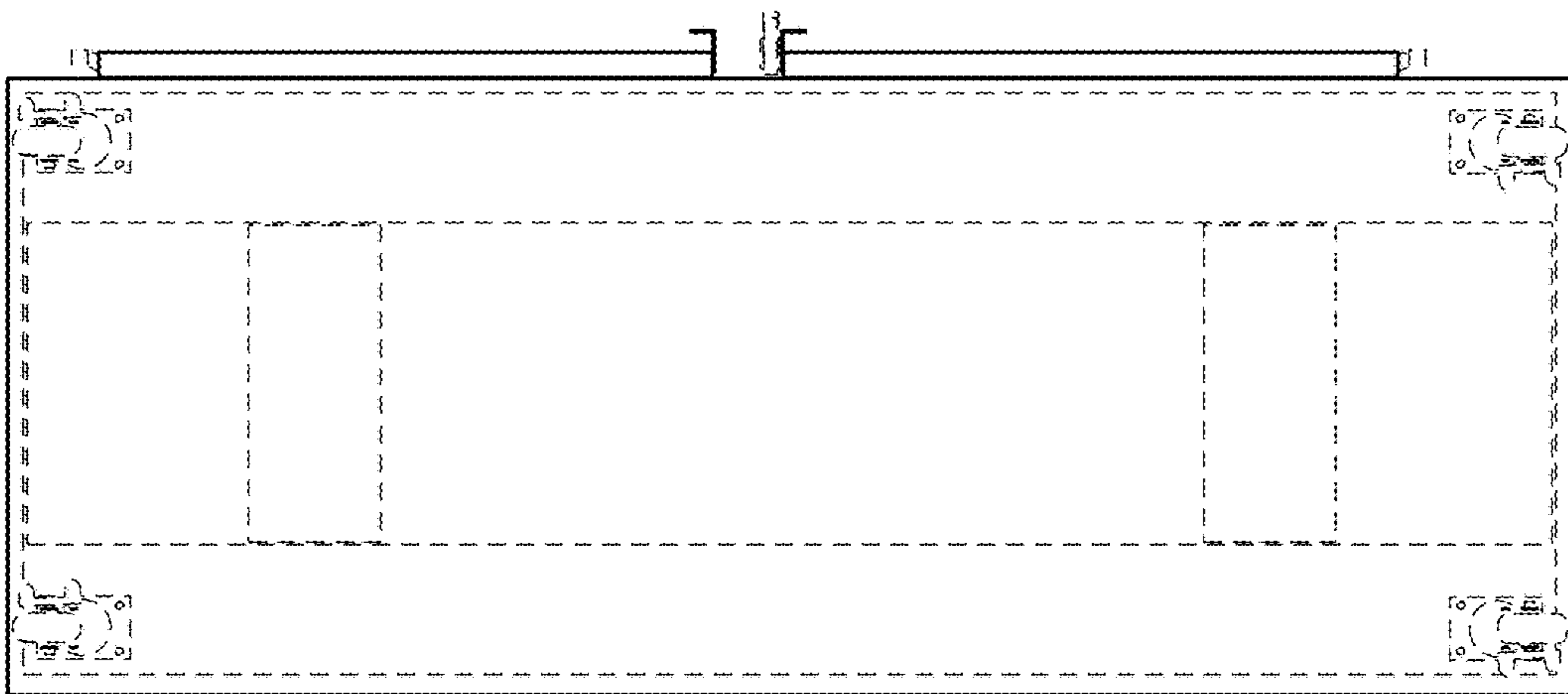

Fig. 21

