



US00D829431S

(12) **United States Design Patent**
Goto

(10) **Patent No.:** **US D829,431 S**
(45) **Date of Patent:** **** Oct. 2, 2018**

- (54) **SHOE**
- (71) Applicant: **NIKE, Inc.**, Beaverton, OR (US)
- (72) Inventor: **Erick Goto**, Portland, OR (US)
- (73) Assignee: **NIKE, Inc.**, Beaverton, OR (US)
- (**) Term: **15 Years**
- (21) Appl. No.: **29/630,344**
- (22) Filed: **Dec. 20, 2017**
- (51) **LOC (11) Cl.** **02-99**
- (52) **U.S. Cl.**
USPC **D2/973**
- (58) **Field of Classification Search**
USPC D2/902, 906-908, 923, 944, 946, 969,
D2/972-975, 978; D5/7, 15, 46, 47, 49,
D5/53
CPC ... A43B 13/181; A43B 13/141; A43B 13/186;
A43B 13/188; A43B 23/00; A43B 23/02;
A43B 5/00; A43B 23/26; A43B 1/04;
A43B 11/14; A43B 7/00; A43B 3/12;
A43C 3/00; A43C 5/00; A43C 7/00;
A43C 11/004
See application file for complete search history.

(56) **References Cited**
U.S. PATENT DOCUMENTS

D504,009 S	4/2005	Matis et al.
D529,706 S	10/2006	Paz
D542,018 S	5/2007	Matis et al.
D546,037 S	7/2007	Belley et al.
D547,040 S	7/2007	Belley et al.
D547,042 S	7/2007	Belley et al.
D560,058 S	1/2008	Belley et al.
D571,990 S	7/2008	James
D577,899 S	10/2008	Belley et al.
D770,159 S	11/2016	Williams, Jr. et al.

D775,811 S	*	1/2017	Walden	D2/972
D781,565 S	*	3/2017	Johnsongriffin	D2/973
D784,681 S		4/2017	Taylor		

(Continued)

OTHER PUBLICATIONS

Shades of Vapormax [online], [retrieved Dec. 18, 2017] retrieved from internet <URL: <https://news.nike.com/news/vapormax-color-inspiration/>>; 17 color sheets, Dated Jun. 22, 2017.
(Continued)

Primary Examiner — Dominic V Simone
(74) Attorney, Agent, or Firm — Banner & Witcoff, Ltd.

(57) **CLAIM**

The ornamental design for a shoe, as shown and described.

DESCRIPTION

FIG. 1 is a front perspective view of a shoe showing my new design;
FIG. 2 is a side view thereof;
FIG. 3 is a rear perspective view thereof;
FIG. 4 is a front view thereof;
FIG. 5 is an opposite side view thereof;
FIG. 6 is a top view thereof;
FIG. 7 is a front perspective view of the shoe of FIGS. 1-6 showing use with an exemplary disclaimed lacing element;
FIG. 8 is a side view thereof;
FIG. 9 is a rear perspective view thereof;
FIG. 10 is a front view thereof;
FIG. 11 is an opposite side view thereof; and,
FIG. 12 is a top view thereof.

The broken lines immediately adjacent to the shaded area define the bounds of the claimed design and form no part thereof. The racetrack-shaped elements shown in broken line represent stitching which forms no part of the claimed design. The broken lines showing the remainder of the shoe are for environmental purposes only and form no part of the claimed design.

1 Claim, 12 Drawing Sheets

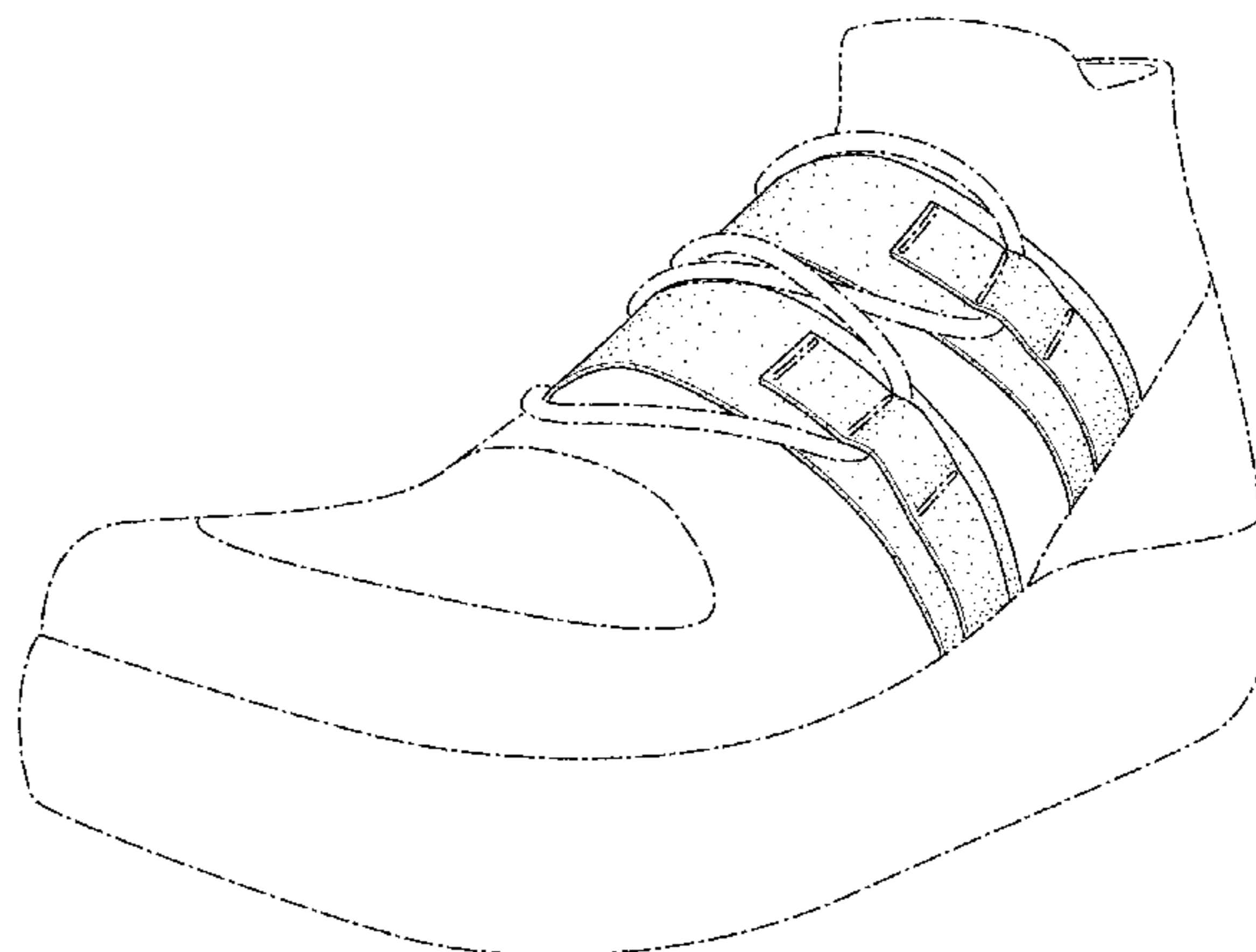
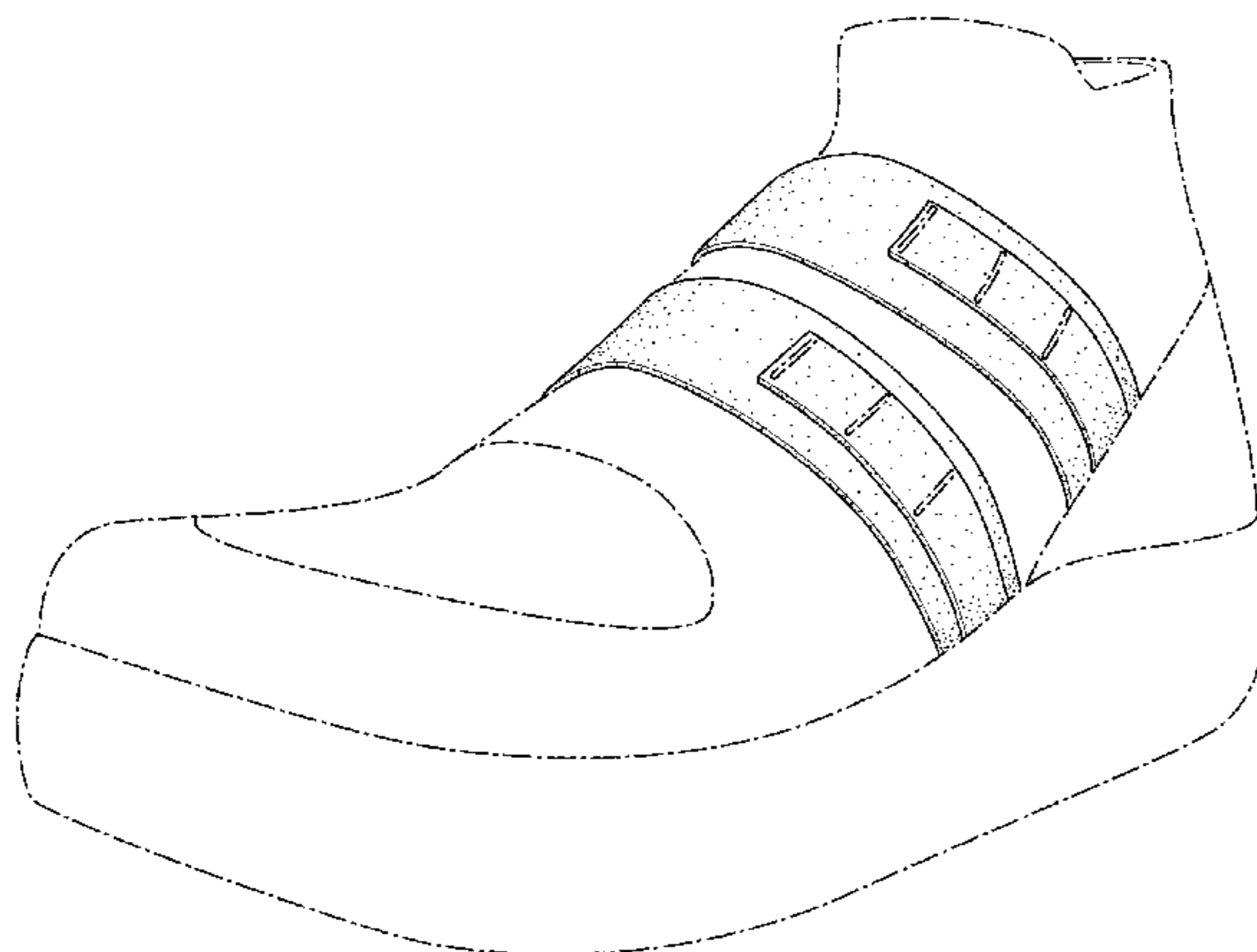

(56)

References Cited

U.S. PATENT DOCUMENTS

D796,182 S 9/2017 Salzano
D801,667 S * 11/2017 Durand D2/972
D808,631 S * 1/2018 Enayah D2/972

OTHER PUBLICATIONS

Another Nike Vapormax Model Appears With a New Flyknit Upper [online], [retrieved Dec. 18, 2017] retrieved from internet <URL: <https://sneakernews.com/2017/07/28/nike-vapormax-white-royal-mid-model/>>; 1 color sheet, Dated Jul. 28, 2017.

Official Look At the Nike Air Vapormax CS Olive [online], [retrieved Dec. 18, 2017] retrieved from internet <URL: <https://www.kicksonfire.com/nike-air-vapormax-cs-olive-official-look/>>; 6 color sheets, Dated Dec. 9, 2017.

Nike Footwear Catalog, 1994 Fall Footwear, p. 140, published Nov. 1993, NIKE, Inc., USA.

Nike Footwear Catalog, 1995 Holiday Footwear, p. 48, published Mar. 1995, NIKE, Inc., USA.

Nike Footwear Catalog, 1996 Spring Footwear, p. 32, published Jun. 1995, NIKE, Inc., USA.

Nike Footwear Catalog, 2018 Spring GC Sub-Partner Sell-in Catalog, p. 9, published May 17, 2017, NIKE, Inc., USA.

* cited by examiner

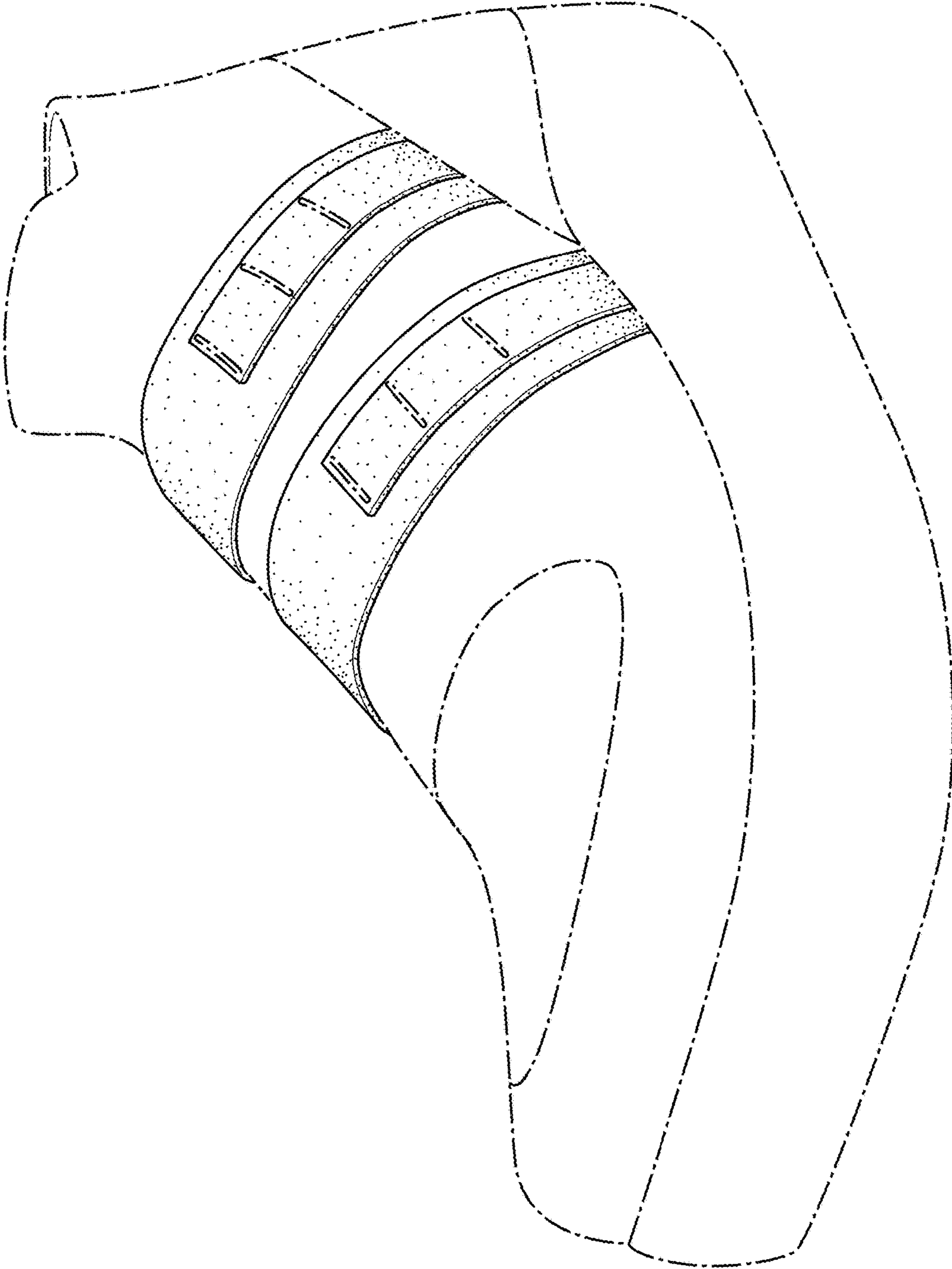

FIG. 1

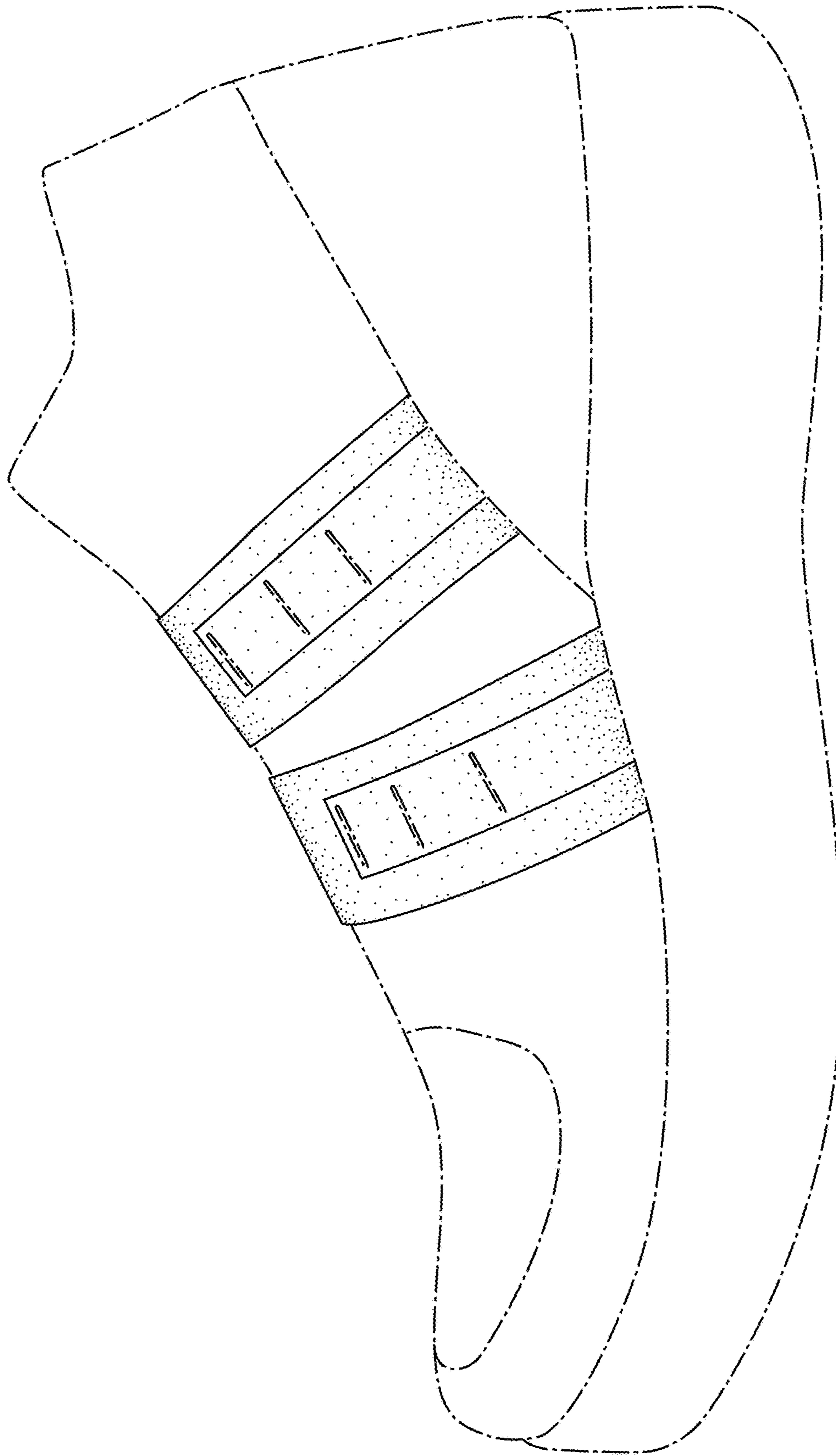

FIG. 2

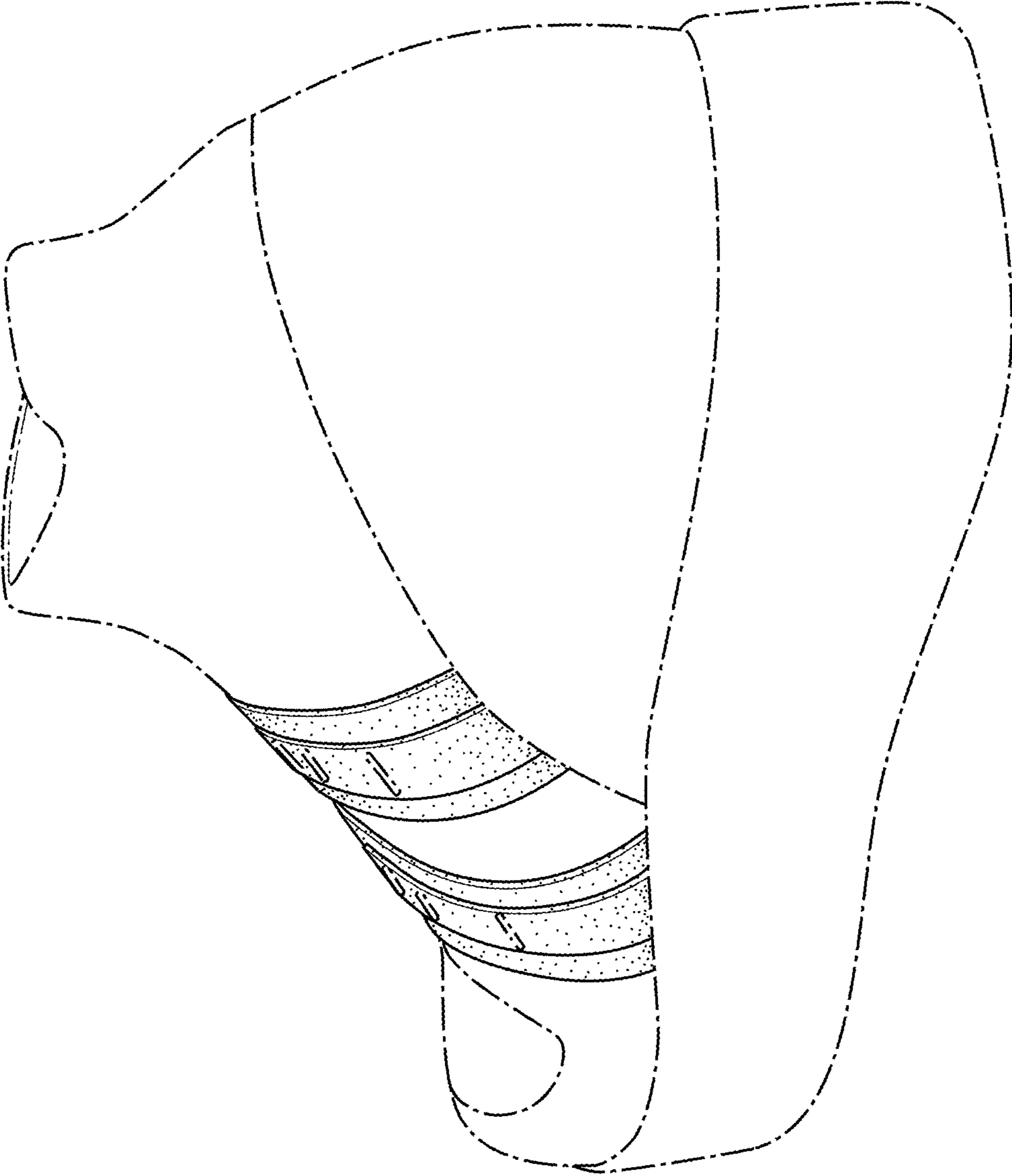

FIG. 3

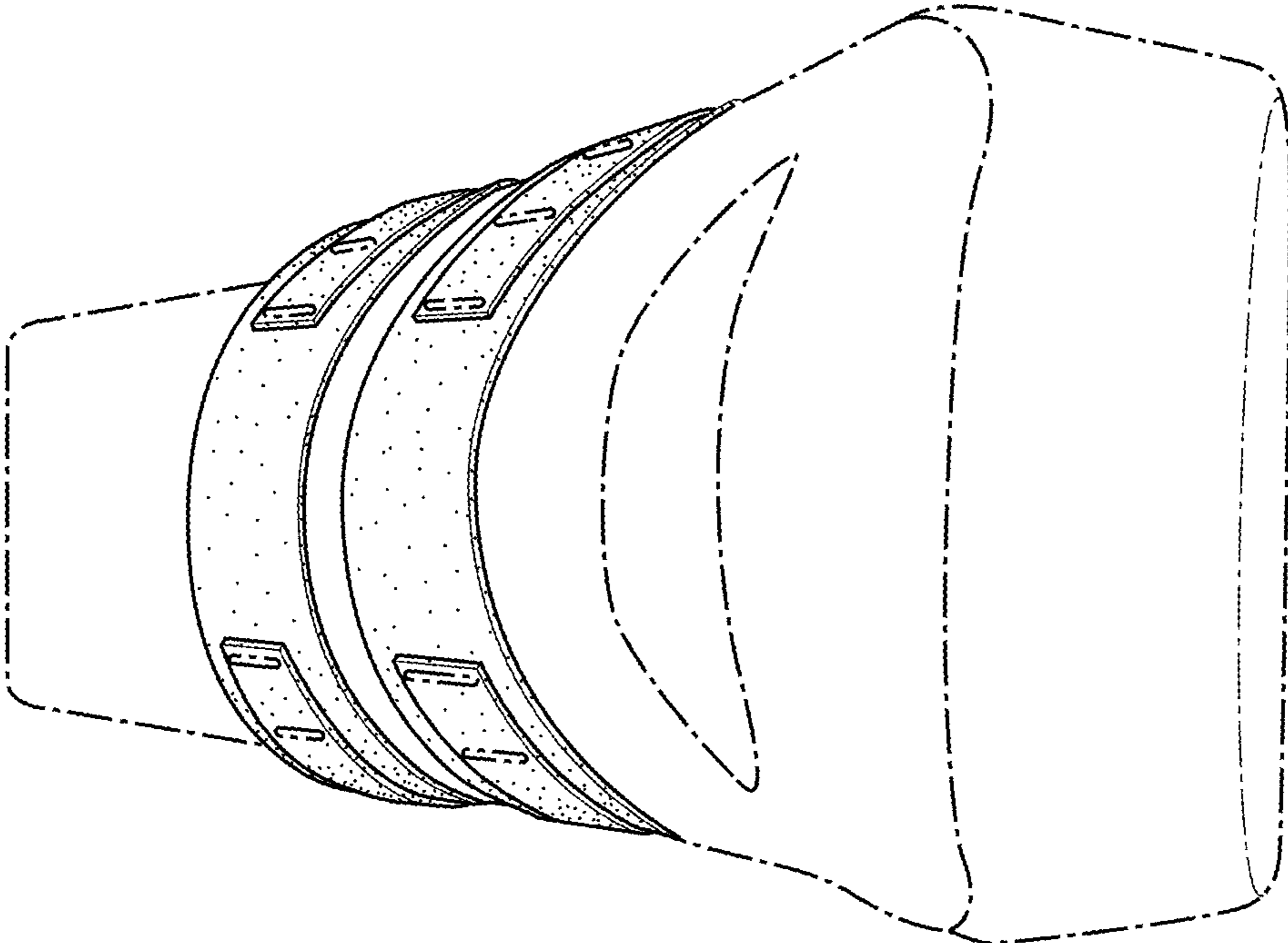

FIG. 4

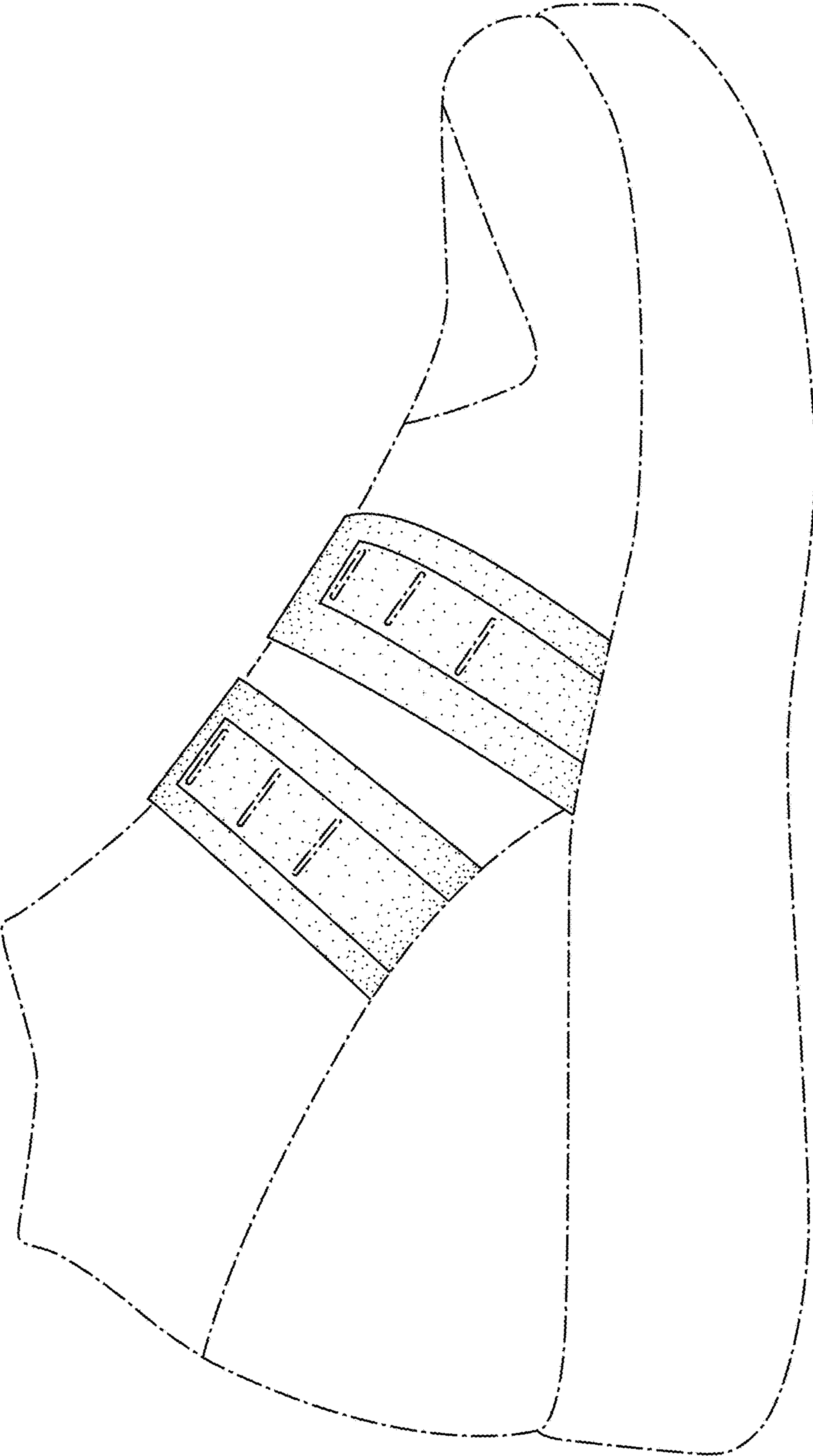

FIG. 5

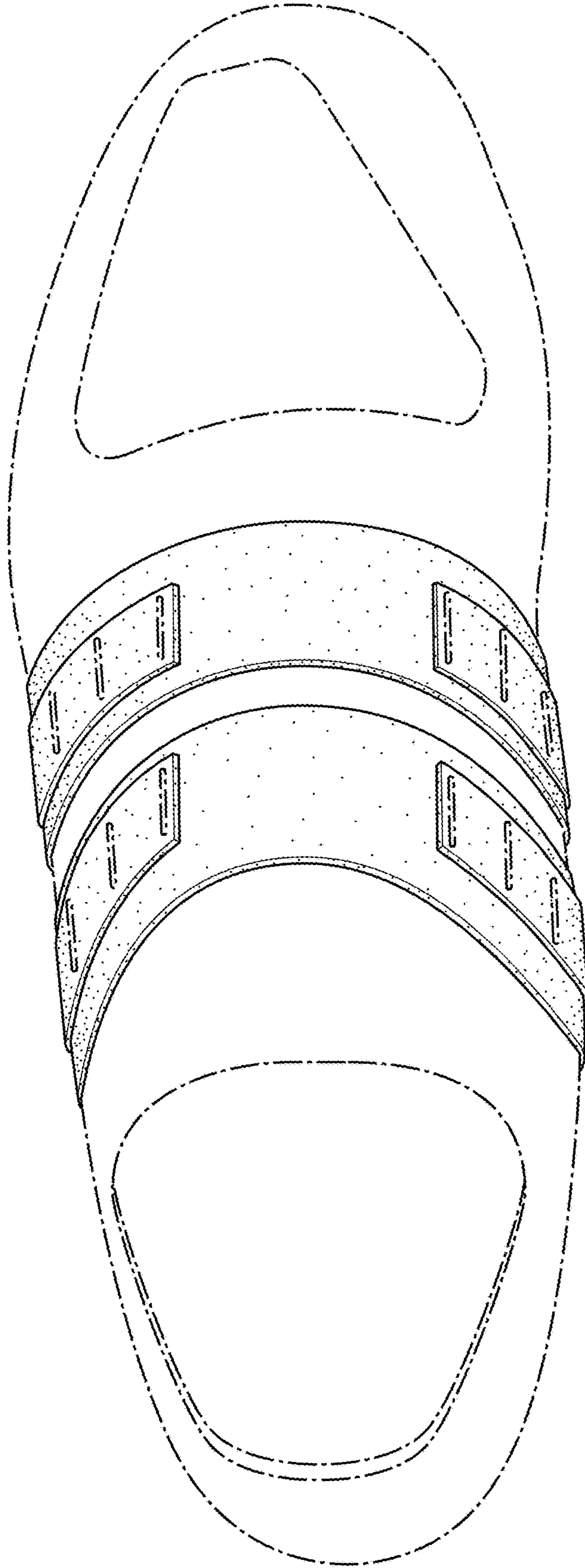

FIG. 6

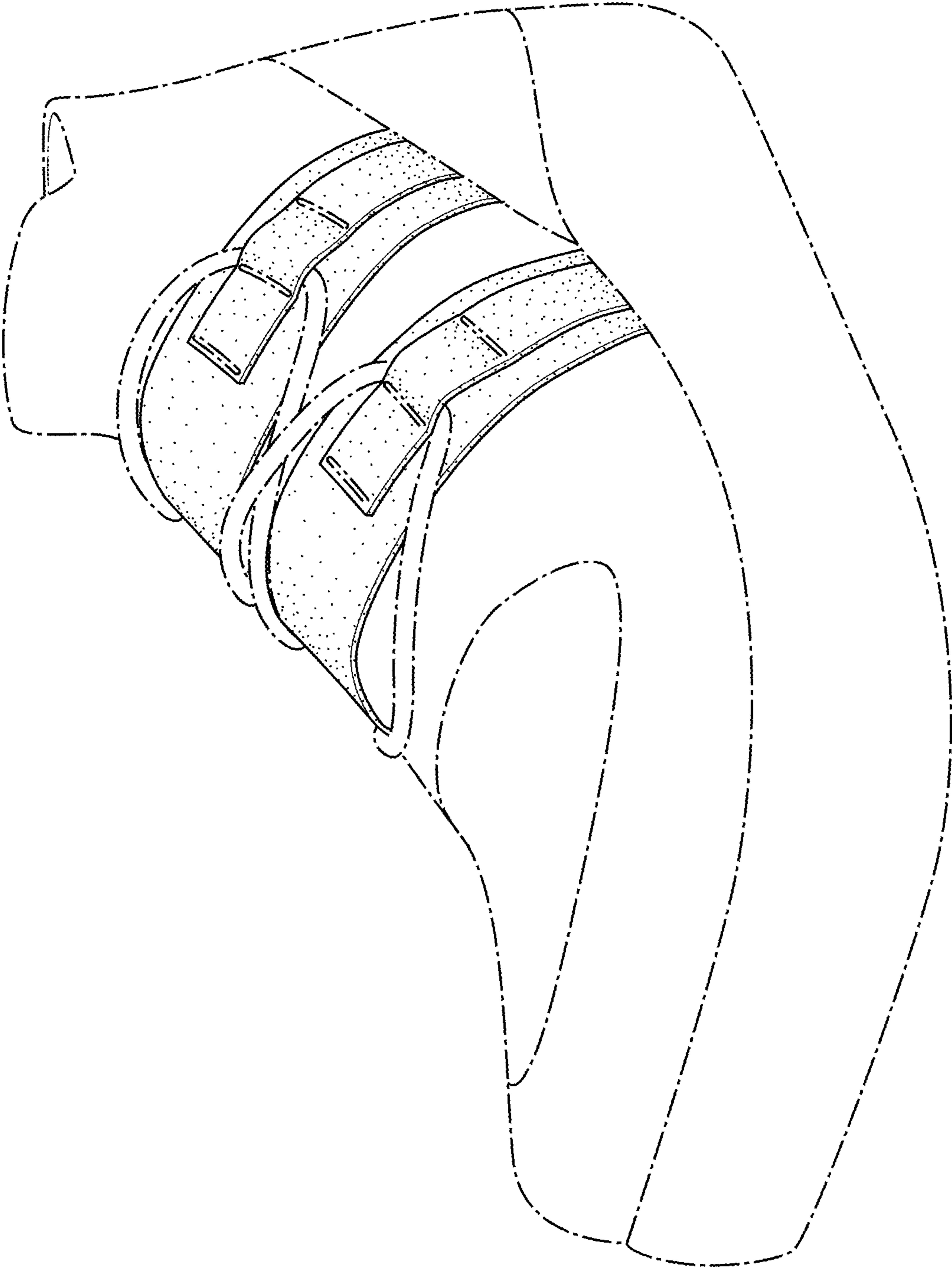

FIG. 7

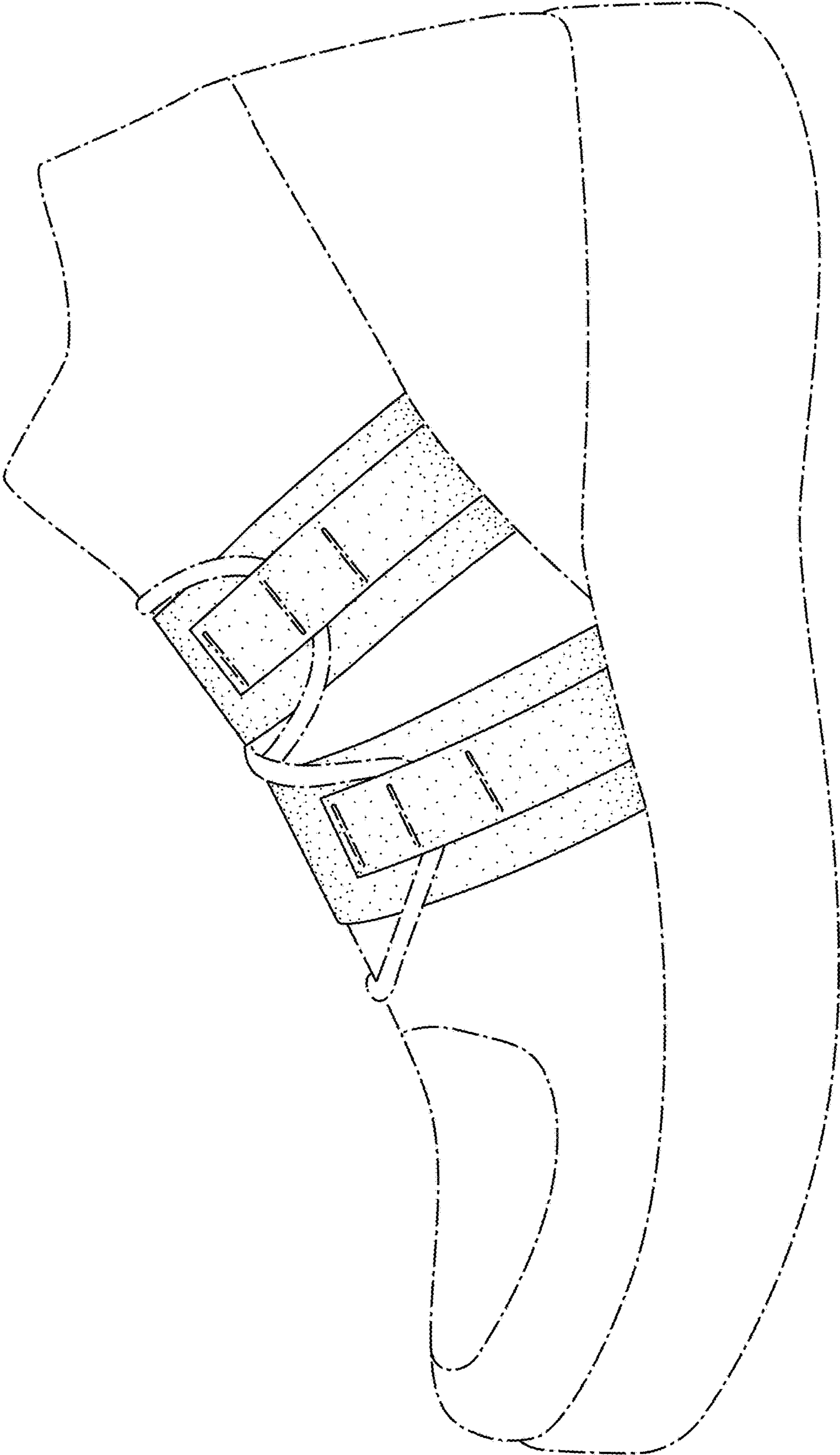

FIG. 8

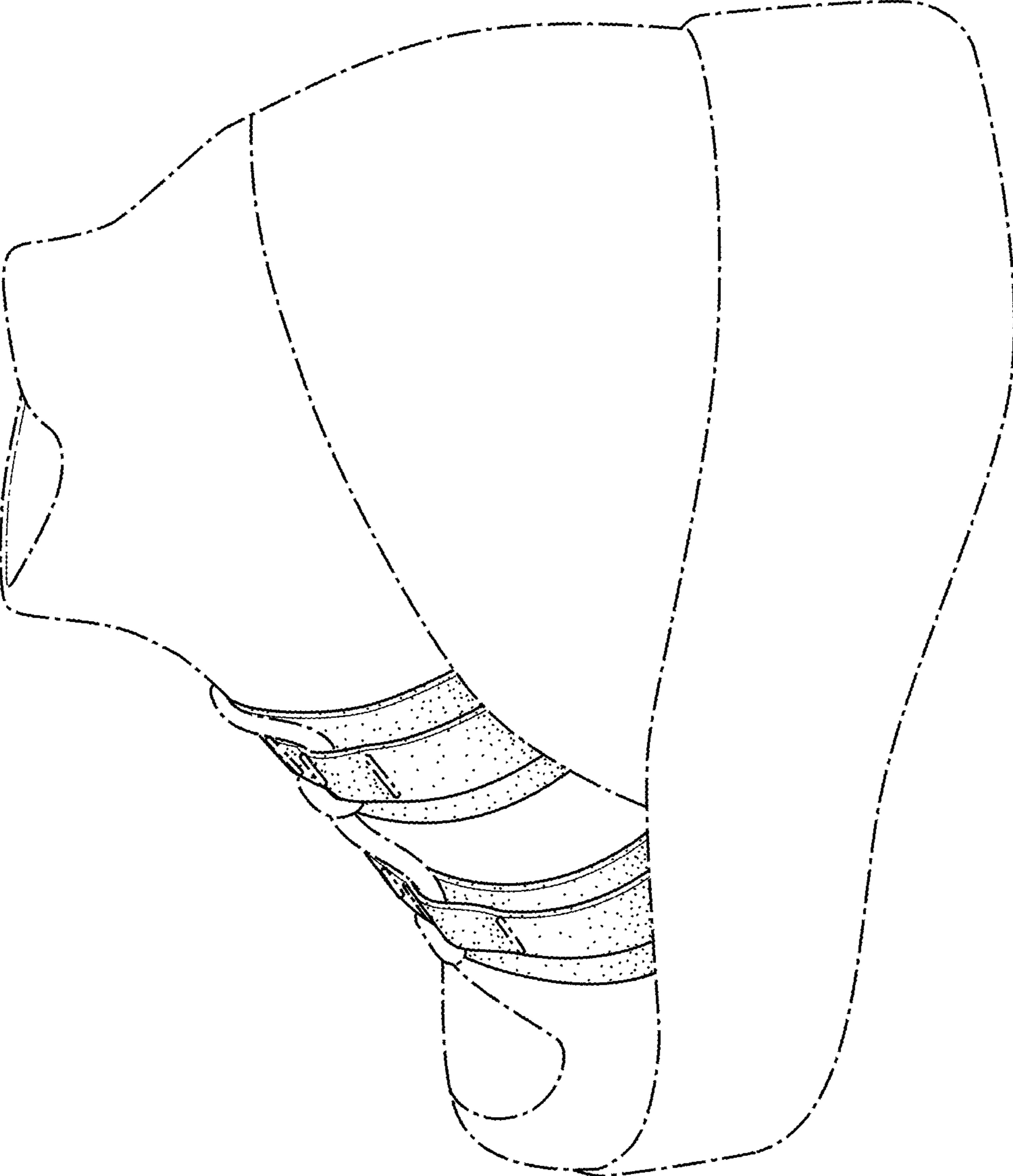

FIG. 9

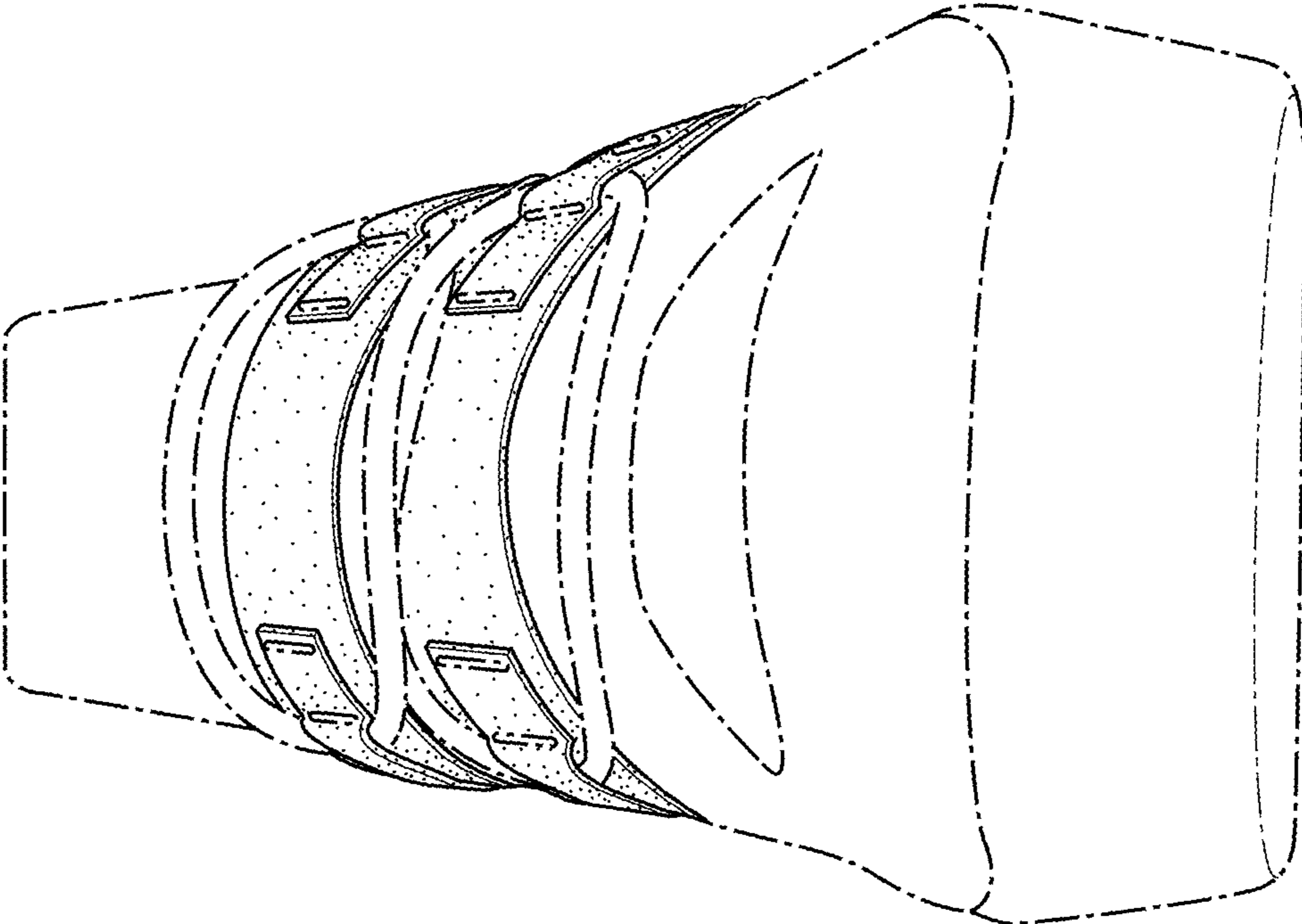

FIG. 10

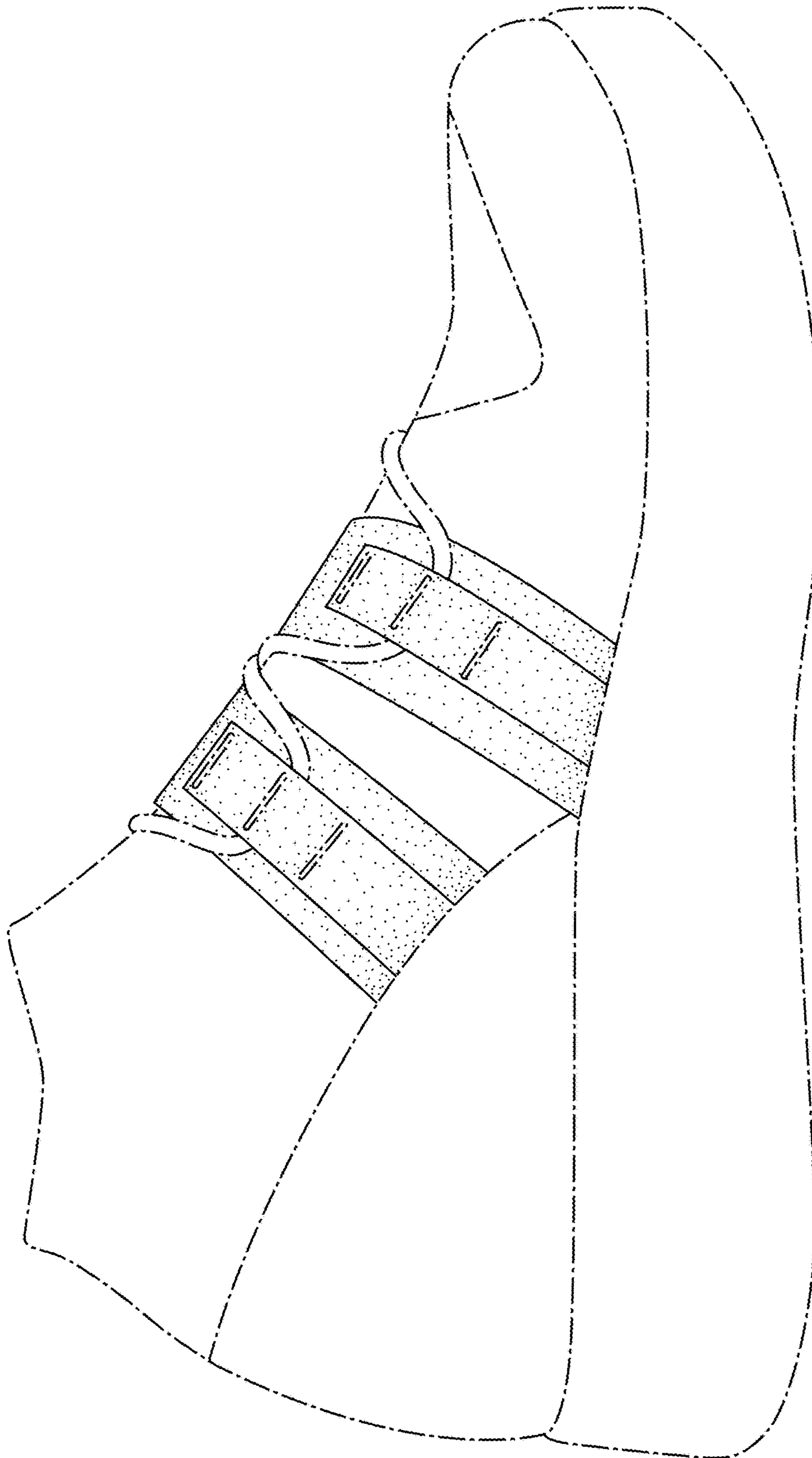

FIG. 11

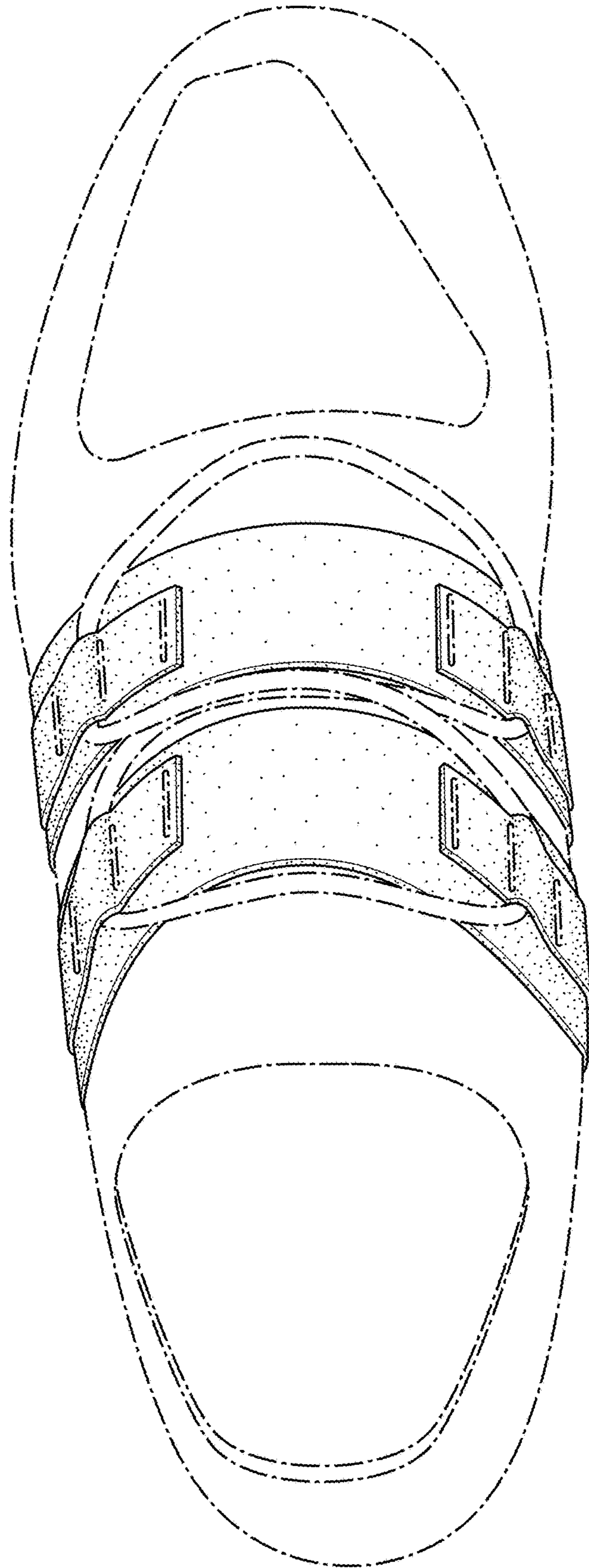

FIG. 12