

US00D829372S

(12) **United States Design Patent**
Huang et al.

(10) **Patent No.:** **US D829,372 S**

(45) **Date of Patent:** **** Sep. 25, 2018**

- (54) **ELECTRONIC CIGARETTE**
- (71) Applicant: **Shenzhen Goldreams Technology Co., Ltd.**, Shenzhen, Guangdong (CN)
- (72) Inventors: **Liangzhi Huang**, Guangdong (CN);
Furong Huang, Guangdong (CN)
- (73) Assignee: **Shenzhen Goldreams Technology Co., Ltd.**, Shenzhen (CN)
- (**) Term: **15 Years**
- (21) Appl. No.: **29/628,869**
- (22) Filed: **Dec. 8, 2017**
- (51) **LOC (11) Cl.** **27-01**
- (52) **U.S. Cl.**
USPC **D27/101**
- (58) **Field of Classification Search**
USPC D27/100, 101, 162, 163–194;
D19/115–123, 161–169; D24/110;
D23/366
CPC A24F 47/008; A24F 47/002; A24F 7/02;
A61M 15/06
See application file for complete search history.

(56) **References Cited**

U.S. PATENT DOCUMENTS

D292,324 S *	10/1987	Decker	D27/170
D585,489 S *	1/2009	Han	D19/117
D639,337 S *	6/2011	Hung	D19/117
D639,338 S *	6/2011	Hung	D19/163
D656,192 S *	3/2012	Chen	D19/163
D656,545 S *	3/2012	Hung	D19/117
D667,876 S *	9/2012	Xie	D19/163
D669,123 S *	10/2012	Jiang	D19/165
D669,124 S *	10/2012	Jiang	D19/163
D721,202 S *	1/2015	Liu	D27/101
D725,310 S *	3/2015	Eksouzian	D27/101
D732,733 S *	6/2015	Spagnolo	D27/101

D752,284 S *	3/2016	Doster	D27/189
D757,352 S *	5/2016	Bagai	D27/101
D757,353 S *	5/2016	Nunnally	D27/101
D770,676 S *	11/2016	Bennett	D27/101
D773,727 S *	12/2016	Eksouzian	D27/101
D775,279 S *	12/2016	Shen	D19/117
D776,337 S *	1/2017	Levin	D27/101
D776,869 S *	1/2017	Heidl	D27/163
D778,492 S *	2/2017	Liu	D27/101
D784,610 S *	4/2017	Bosch	D27/101
D786,497 S *	5/2017	Sudlow	D27/162
D788,697 S *	6/2017	Verleur	D13/103
D790,126 S *	6/2017	Bennett	D27/101
D792,643 S *	7/2017	Wong	D27/101
D799,110 S *	10/2017	Qiu	D27/101
D799,112 S *	10/2017	Qiu	D27/101
D799,113 S *	10/2017	Qiu	D27/101
D799,745 S *	10/2017	Qiu	D27/101
D800,383 S *	10/2017	Verleur	D27/167

(Continued)

Primary Examiner — Brandon M Rosati

Assistant Examiner — Marissa J Cash

(57) **CLAIM**

The ornamental design for an electronic cigarette, as shown and described.

DESCRIPTION

FIG. 1 is a front elevational view of an electronic cigarette showing our new design;
 FIG. 2 is a rear elevational view thereof;
 FIG. 3 is a left side view thereof;
 FIG. 4 is a right side view thereof;
 FIG. 5 is a top plan view thereof;
 FIG. 6 is a bottom plan view thereof;
 FIG. 7 is a first perspective view thereof; and,
 FIG. 8 is a second perspective view thereof.
 The broken lines in the drawings illustrate portions of the electronic cigarette which form no part of the claimed design.

1 Claim, 8 Drawing Sheets

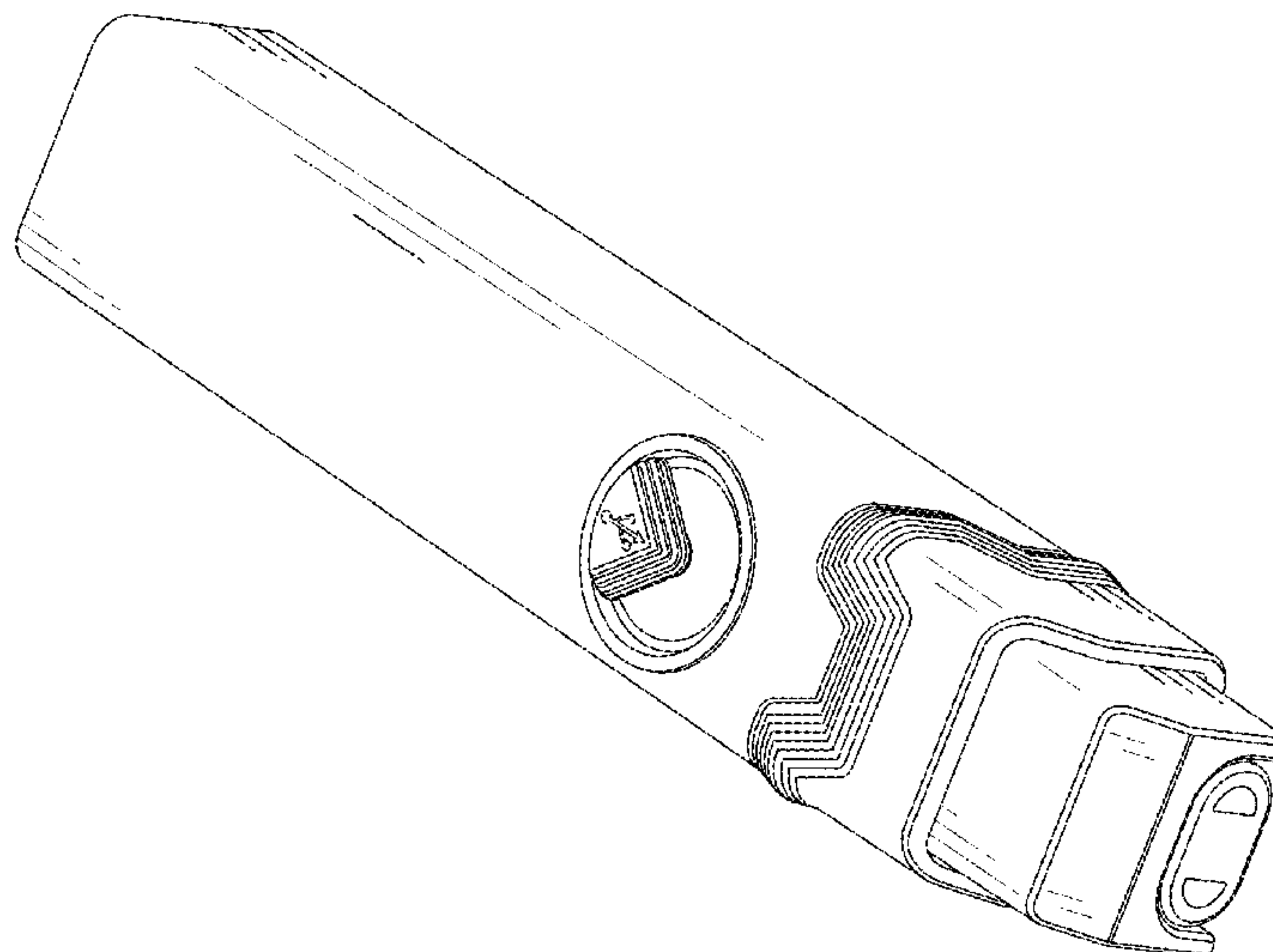

(56)

References Cited

U.S. PATENT DOCUMENTS

D800,566 S * 10/2017 Wieland D9/529
D805,684 S * 12/2017 Thuery D27/101
D813,447 S * 3/2018 Watson D27/162
D815,341 S * 4/2018 Qiu D27/101
D816,267 S * 4/2018 Fornarelli D27/101
D818,636 S * 5/2018 Qiu D27/101
D819,263 S * 5/2018 Zhu D27/101
D819,881 S * 6/2018 Qiu D27/101
2014/0283858 A1 * 9/2014 Liu A24F 47/008
131/329
2015/0034104 A1 * 2/2015 Zhou A24F 47/008
131/329
2016/0331912 A1 * 11/2016 Trzeczieski A61M 11/042
2017/0215478 A1 * 8/2017 Harrison A24F 47/008
2017/0258142 A1 * 9/2017 Hatton A24F 47/008
2018/0042302 A1 * 2/2018 Robinson A24F 47/008
2018/0098571 A1 * 4/2018 Watson A24F 47/008
2018/0117268 A1 * 5/2018 Selby A61M 11/042
2018/0153221 A1 * 6/2018 Verleur A24F 47/008
2018/0177234 A1 * 6/2018 Lee A24F 47/008

* cited by examiner

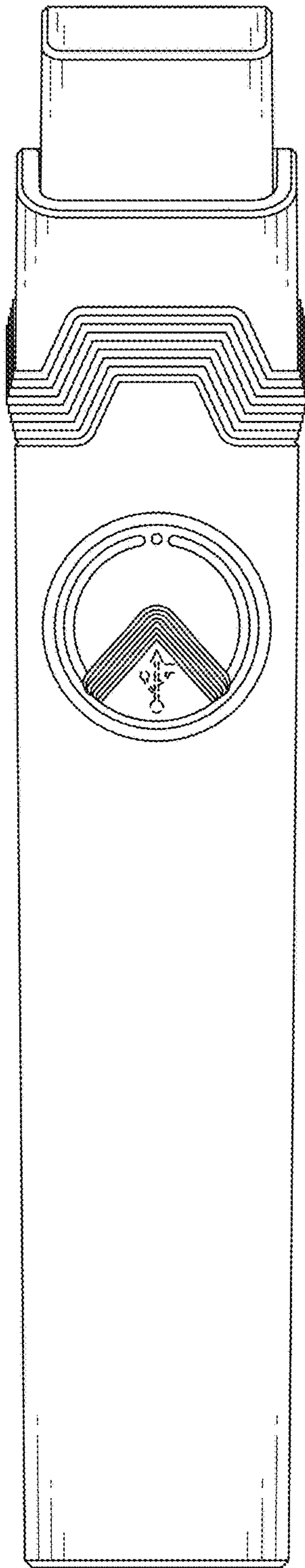

FIG.1

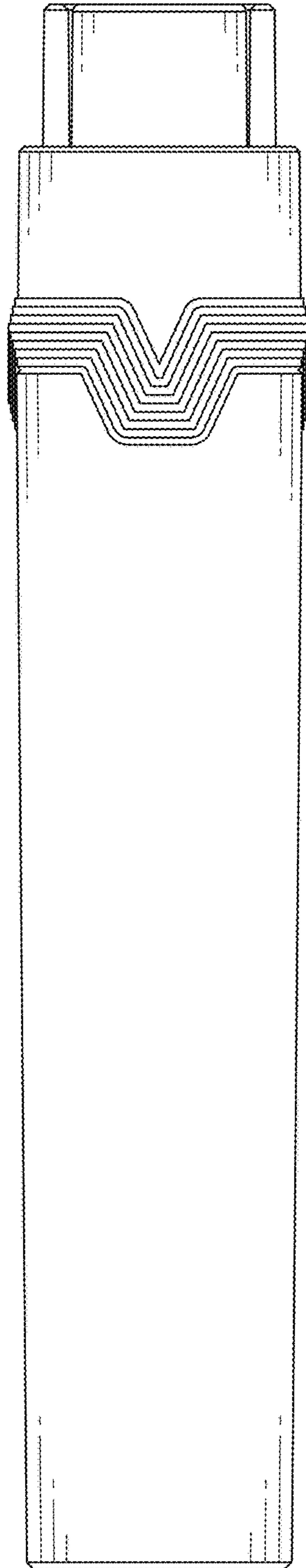

FIG.2

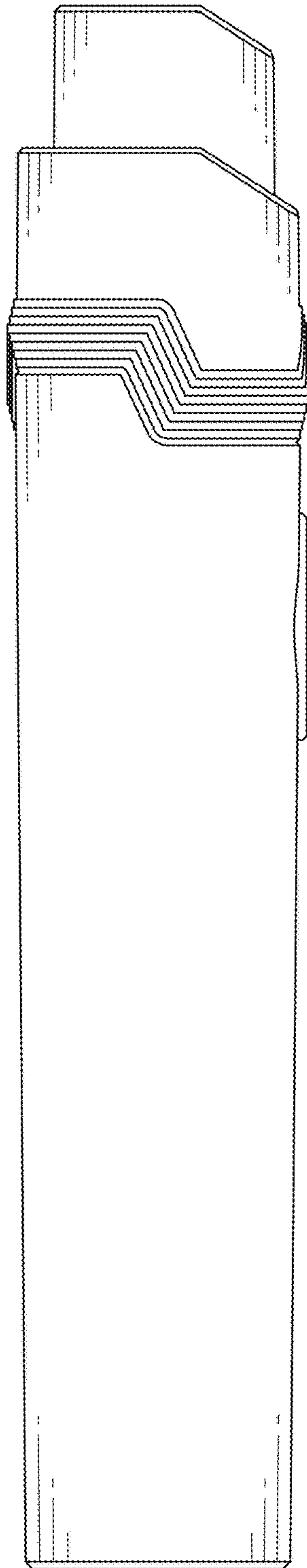

FIG.3

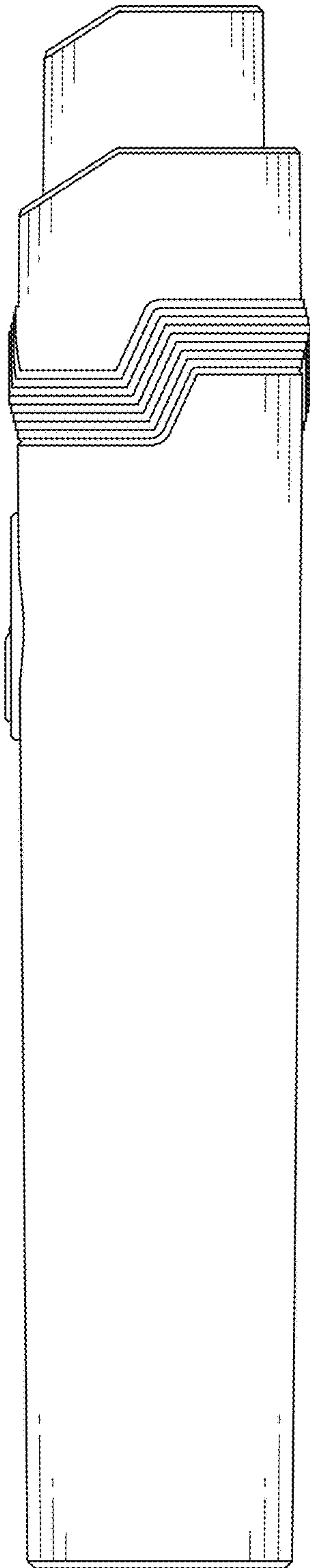

FIG.4

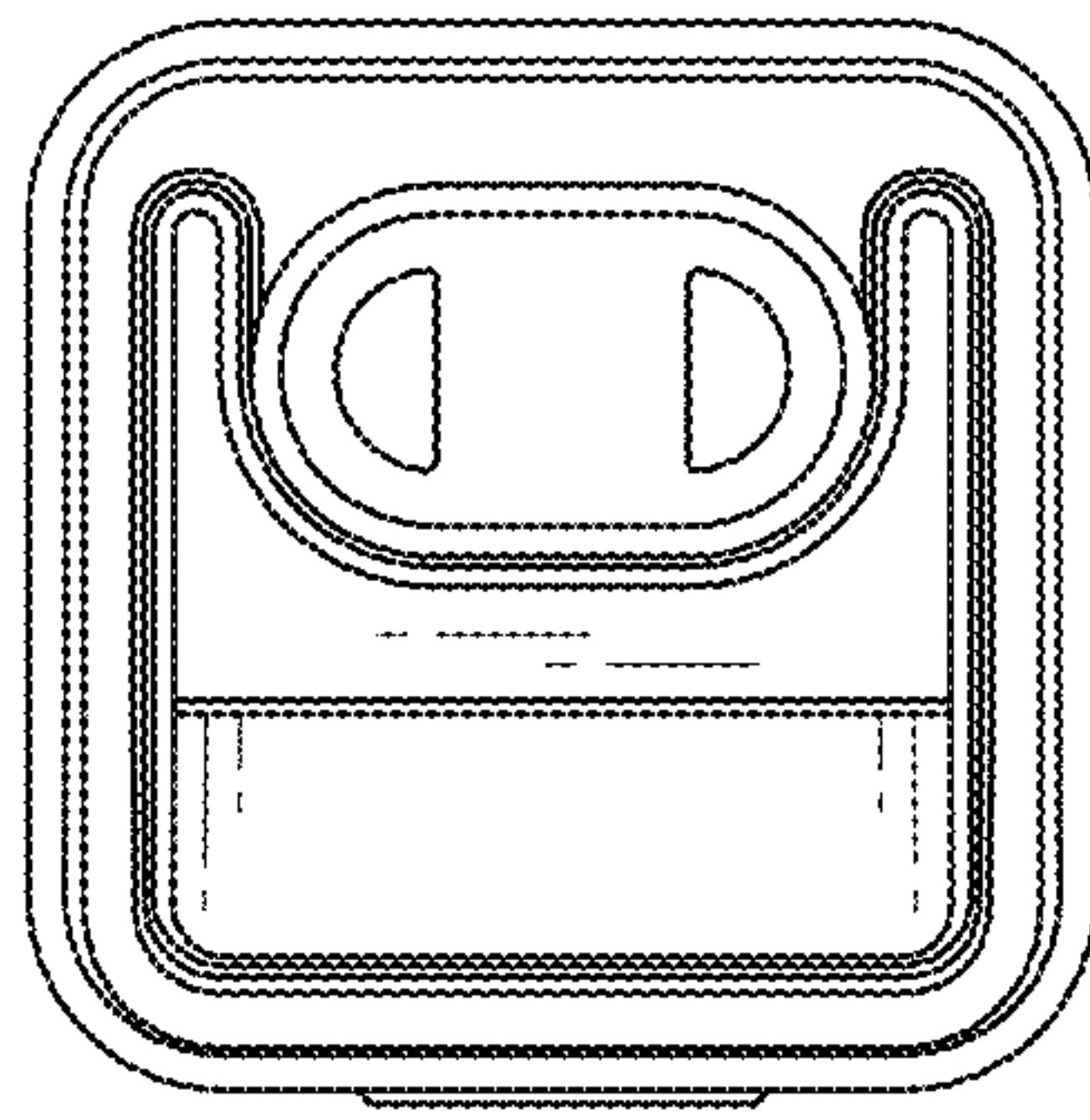

FIG.5

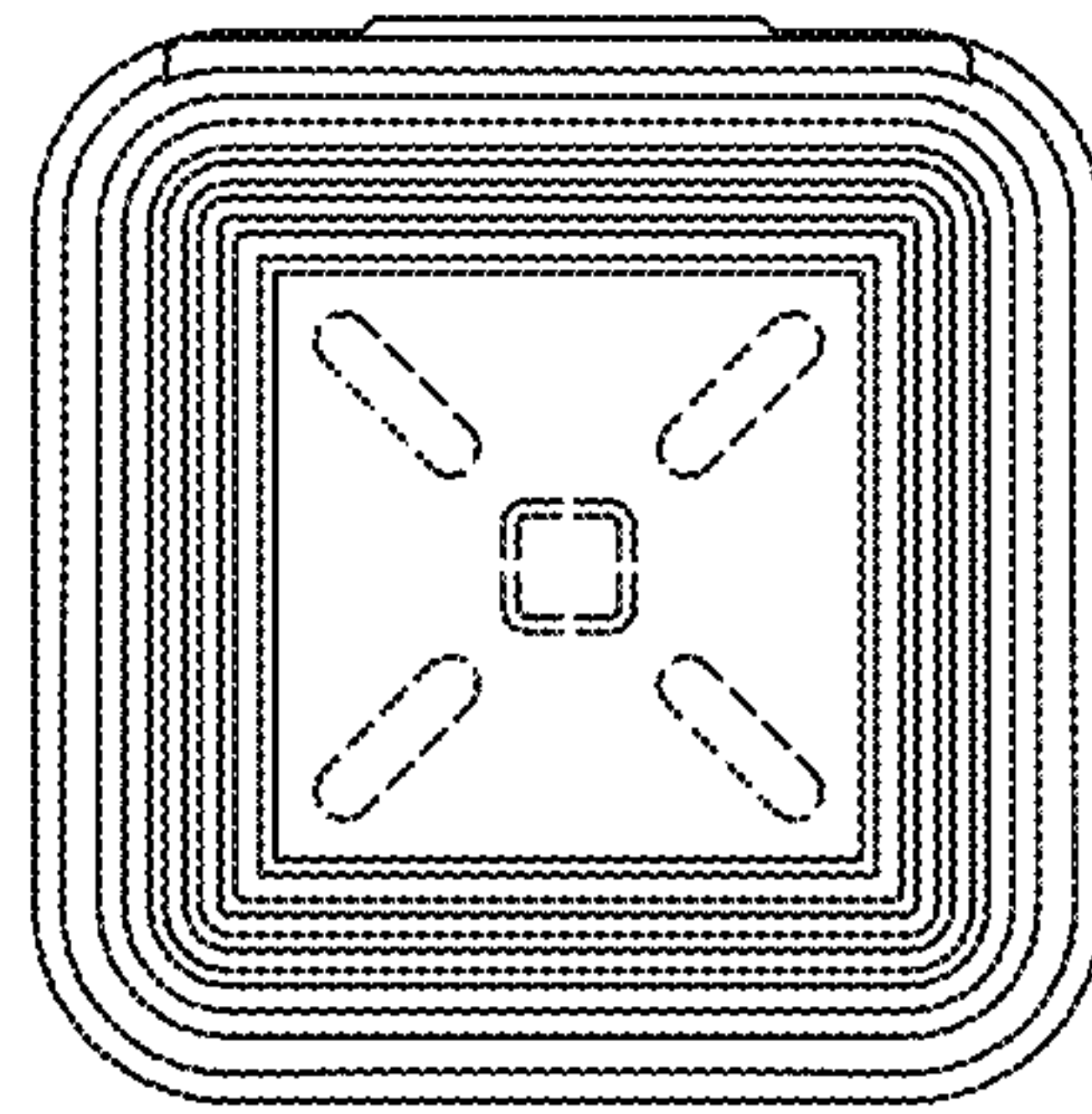

FIG.6

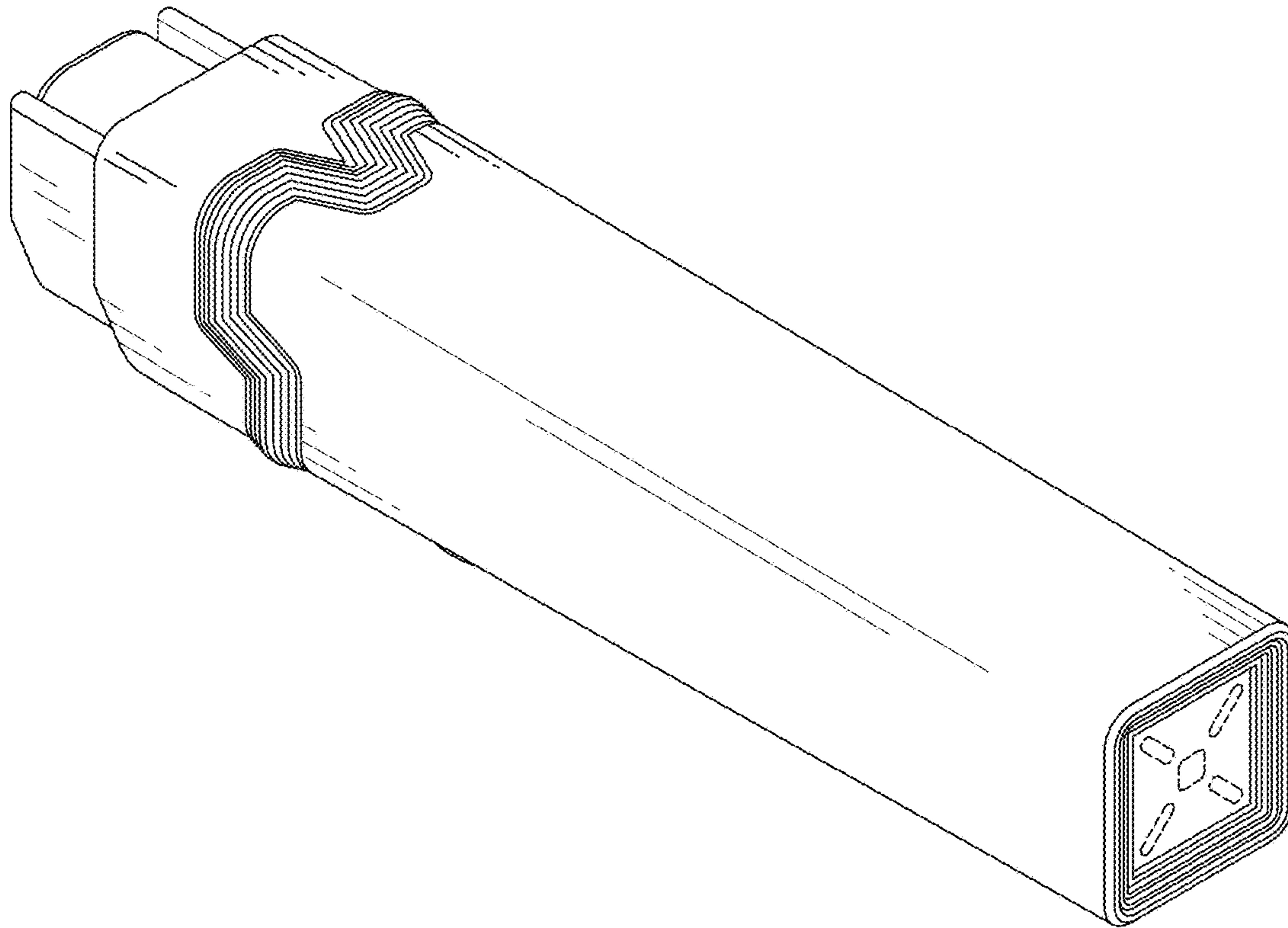

FIG.7

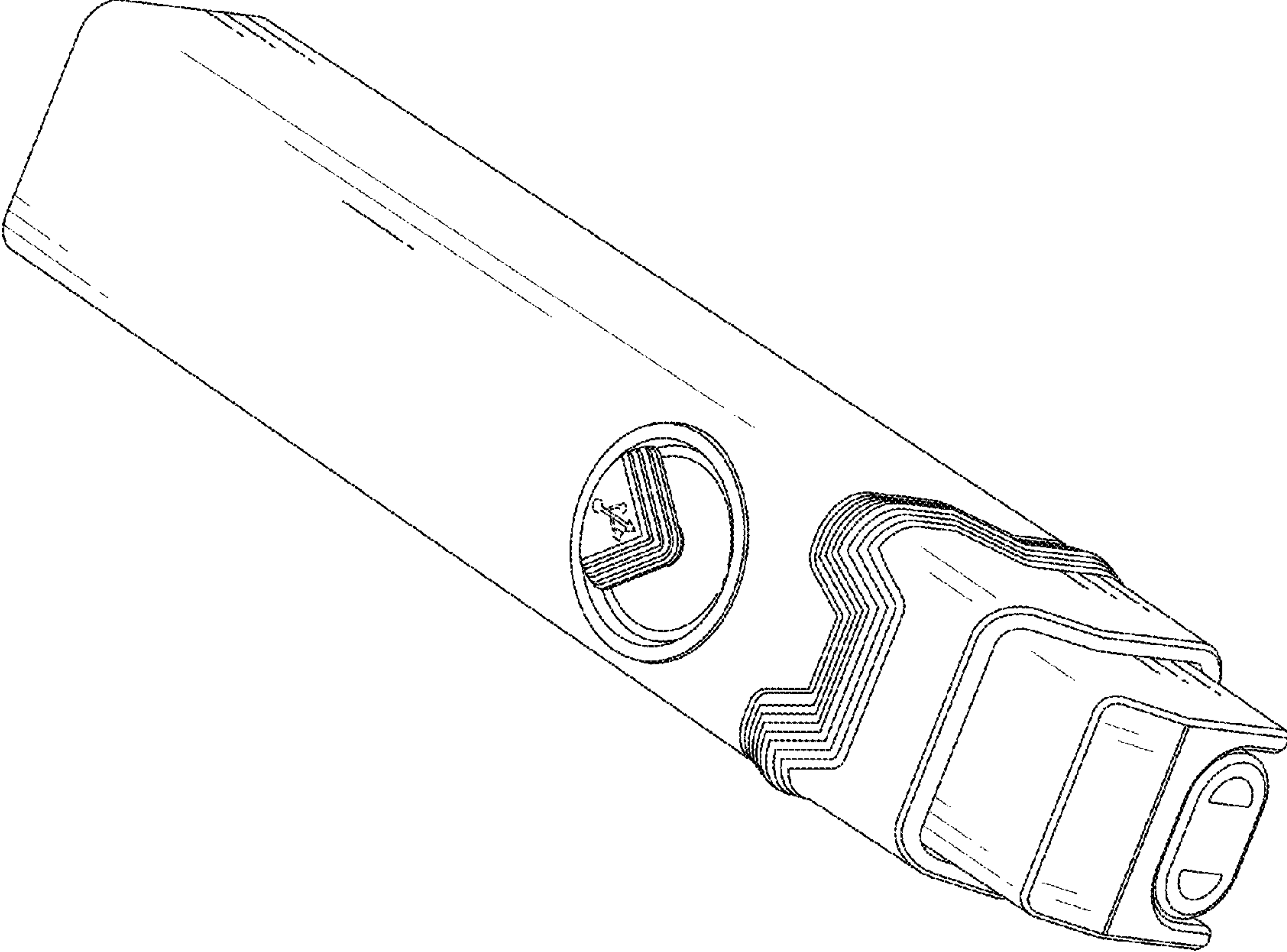

FIG.8