

US00D829367S

(12) **United States Design Patent** (10) **Patent No.:** **US D829,367 S**
Momin (45) **Date of Patent:** **** Sep. 25, 2018**

(54) **LIGHT FIXTURE**
(71) Applicant: **ABL IP Holding LLC**, Decatur, GA (US)
(72) Inventor: **Mohamed Momin**, Scottsdale, GA (US)
(73) Assignee: **ABL IP Holding LLC**, Atlanta, GA (US)
(**) Term: **15 Years**
(21) Appl. No.: **29/599,252**
(22) Filed: **Mar. 31, 2017**
(51) **LOC (11) Cl.** **26-99**
(52) **U.S. Cl.**
USPC **D26/124**
(58) **Field of Classification Search**
USPC D26/1, 72, 74, 85, 89, 113, 118, 119, D26/120, 122.124; D13/180
CPC F21V 29/2262; F21V 7/06; F21V 21/044; F21V 21/047; F21V 29/2212; F21V 29/2225; F21V 29/2256; F21V 29/2268; F21Y 211/002; F21S 8/02; F21S 8/026
See application file for complete search history.

D663,880 S 7/2012 Janssen
D663,881 S * 7/2012 Janssen D26/74
D667,985 S 9/2012 Gielen
D681,867 S 5/2013 Wegger et al.
(Continued)

FOREIGN PATENT DOCUMENTS

CA 33930 3/1971

OTHER PUBLICATIONS

“4” Square Slim Recessed LED Neutral White 11W (LY4S/30K),”
www.lotusLEDlights.com, 2 pages (available at least on Jan. 9, 2017).

(Continued)

Primary Examiner — Brian N Vinson
(74) *Attorney, Agent, or Firm* — Kilpatrick Townsend & Stockton LLP

(57) **CLAIM**

The ornamental design for a light fixture, as shown and described.

DESCRIPTION

FIG. 1 is a bottom perspective view of a light fixture showing my new, original, and ornamental design, which includes a central portion surrounded by a perimeter portion and recessed with respect to the perimeter portion; FIG. 2 is a top perspective view thereof; FIG. 3 is a right side elevation view thereof; FIG. 4 is a left side elevation view thereof; FIG. 5 is a front elevation view thereof; FIG. 6 is a back elevation view thereof; FIG. 7 is a top plan view thereof; and, FIG. 8 is a bottom plan view thereof. The broken line disclosure represents portions of the fixture which form no part of the claimed design.

1 Claim, 6 Drawing Sheets

(56) **References Cited**
U.S. PATENT DOCUMENTS

D453,521 S 2/2002 Haruna et al.
7,063,441 B2 6/2006 Kramer et al.
D581,089 S 11/2008 St-Hilaire
D583,981 S 12/2008 Meyer et al.
D601,744 S 10/2009 Sakuma
D622,876 S * 8/2010 Takahashi D26/1
D628,737 S * 12/2010 van den Akker D26/89
D639,496 S 6/2011 Wada et al.
D641,520 S 7/2011 Grajcar
D650,760 S * 12/2011 Hussell D13/180
D655,849 S 3/2012 Sabernig
D656,264 S 3/2012 Janssen
D658,603 S * 5/2012 Egawa D13/180
D658,604 S 5/2012 Egawa et al.

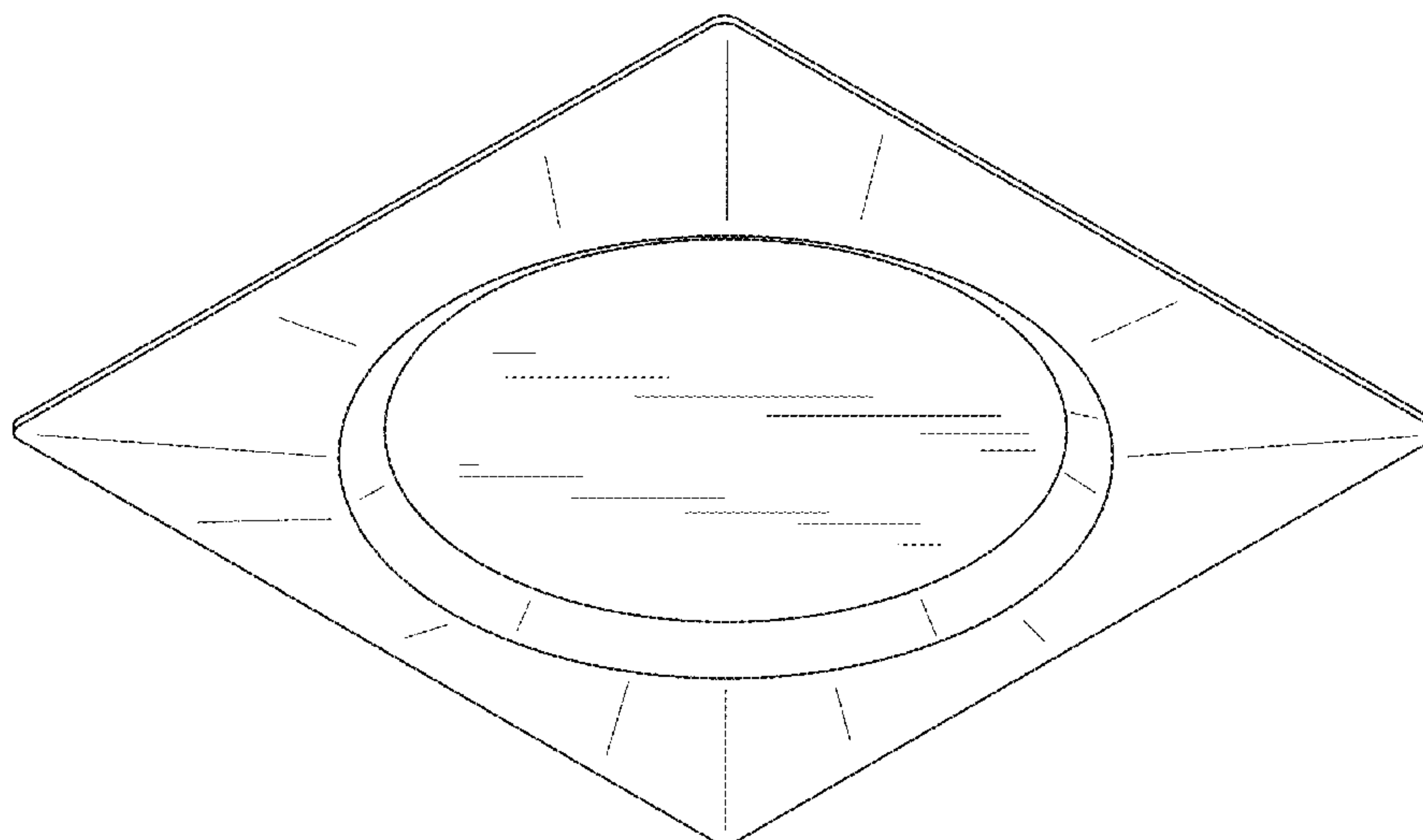

(56)

References Cited

U.S. PATENT DOCUMENTS

| | | | | | |
|------------|---|---------|--------------|-------|--------|
| D767,808 S | * | 9/2016 | Lehman | | D26/74 |
| D770,075 S | * | 10/2016 | Huang | | D26/74 |
| D779,101 S | | 2/2017 | Redfern | | |
| D799,101 S | | 10/2017 | Amato et al. | | |
| D805,674 S | | 12/2017 | Salomon | | |

OTHER PUBLICATIONS

“4” Square Slim Recessed LED Soft White 11W (LY4S/41K),” www.lotusLEDlights.com, 2 pages (available at least on Jan. 9, 2017).
 Lotus LED Lights, 6” Square Slim Recessed LED Soft White 14W (LY6S/41K), 2 pages (available at least on Jan. 9, 2017).
 Lotus LED Lights, 6” Square Slim Recessed LED Neutral White 14W (LY6S/41K), 2 pages (available at least on Jan. 9, 2017).
 “LED Lighting Catalog,” Nicor Shine Brighter vol. 3, 2016, 128 pages.
 Topaz, “LED Retrofit,” 10 Watt LED Retrofit Module with 4” White Square Baffle Trim, www.topaz-usa.com, 2009, 4 pages.
 “PR15 Ultra-Thin LED,” LED Waves Inc, All Rights Reserved V5-2-17 www.ledwaves.com, p: 212.677.6400, 2016, 2 pages.

“PR15 Ultra-thin LED Recessed Light Installation Guide,” LED Waves, Inc All Rights Reserved. V5-4-17 <www.ledwaves.com>, 2017, 7 pages.
 “Topaz,” Solid State Lighting LED Retrofit Lamps & Fixtures, 2016, 32 pages.
 Recessed LED Lighting, “Designer Series Square LED Panel,” Stocking Guide, 2017, pp. 66-67.
 Examiner’s Report for Canadian Design Application No. 174580, dated Dec. 11, 2017, 1 page.
 Examiner’s Report for Canadian Design Application No. 174581, dated Dec. 11, 2017, 1 page.
 Non-Final Office Action for U.S. Appl. No. 29/599,203, dated Jan. 16, 2018, 15 pages.
 Non-Final Office Action for U.S. Appl. No. 29/599,213, dated Jan. 16, 2018, 15 pages.
 Non-Final Office Action for U.S. Appl. No. 29/599,226, dated Jan. 16, 2018, 15 pages.
 Non-Final Office Action for U.S. Appl. No. 29/599,232, dated Jan. 16, 2018, 15 pages.
 Non-Final Office Action for U.S. Appl. No. 29/599,238, dated Jan. 16, 2018, 15 pages.
 Non-Final Office Action for U.S. Appl. No. 29/599,245, dated Jan. 16, 2018, 15 pages.
 Non-Final Office Action for U.S. Appl. No. 29/599,248, dated Jan. 16, 2018, 15 pages.

* cited by examiner

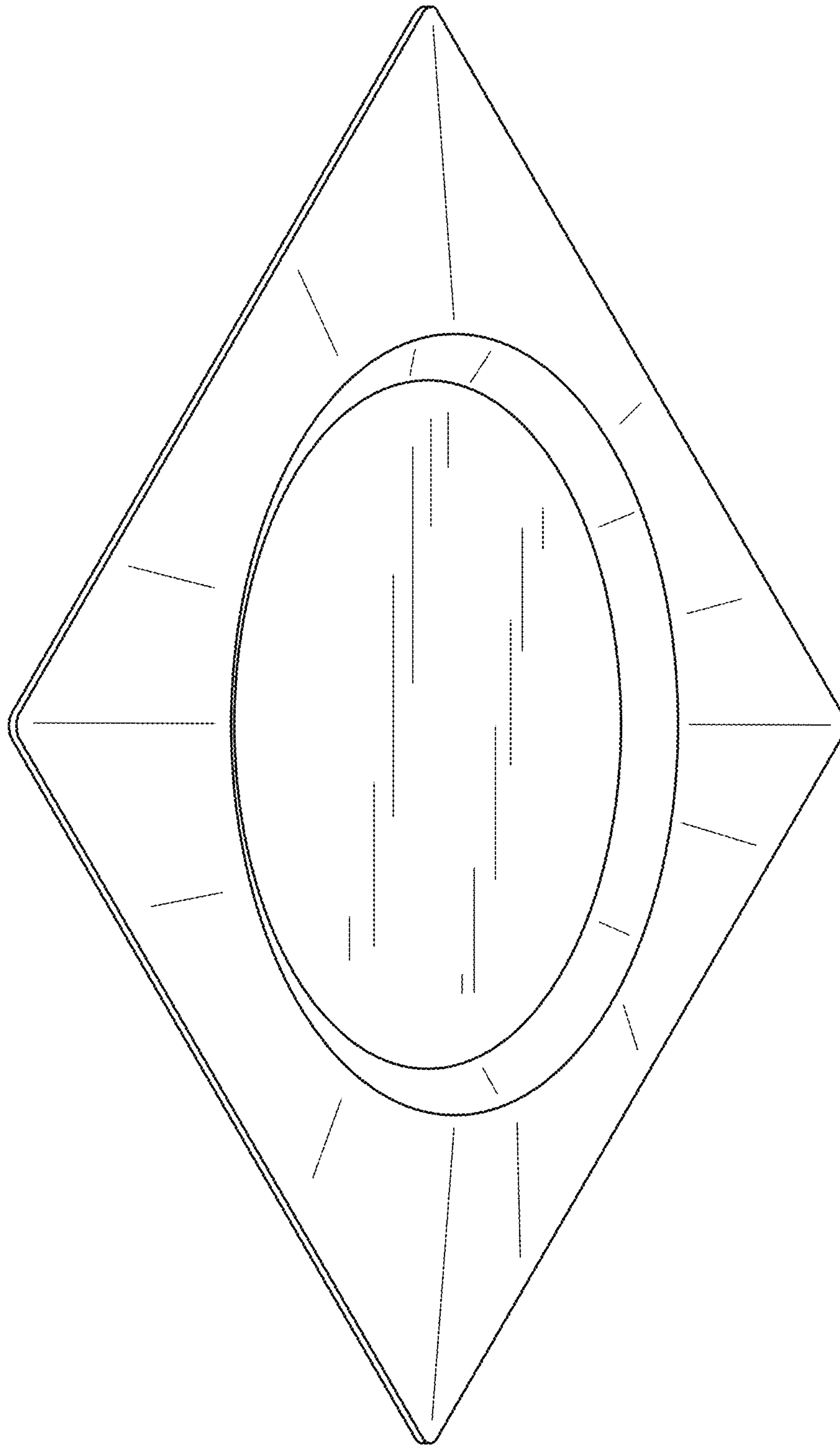

FIG.1

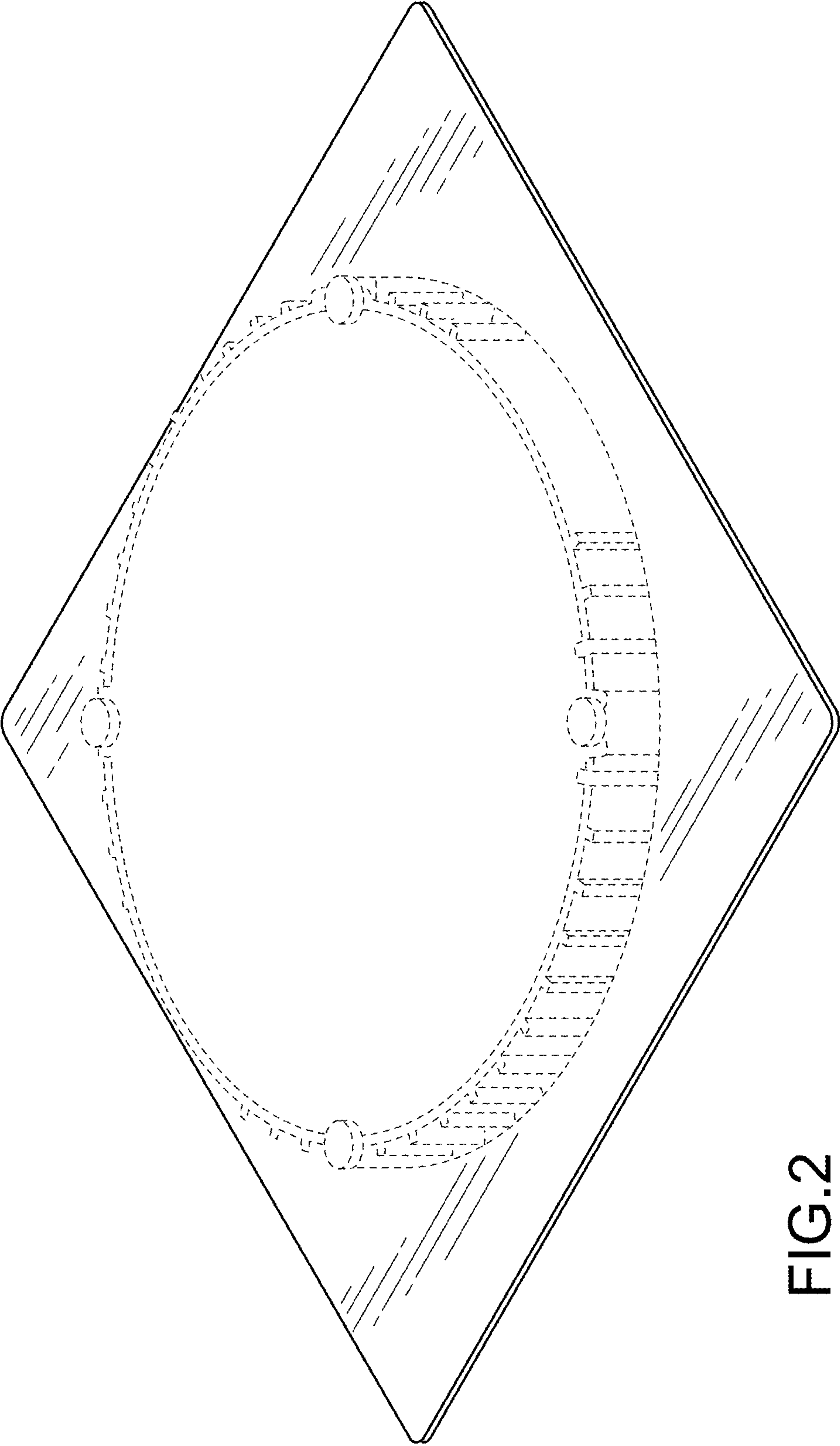

FIG.2

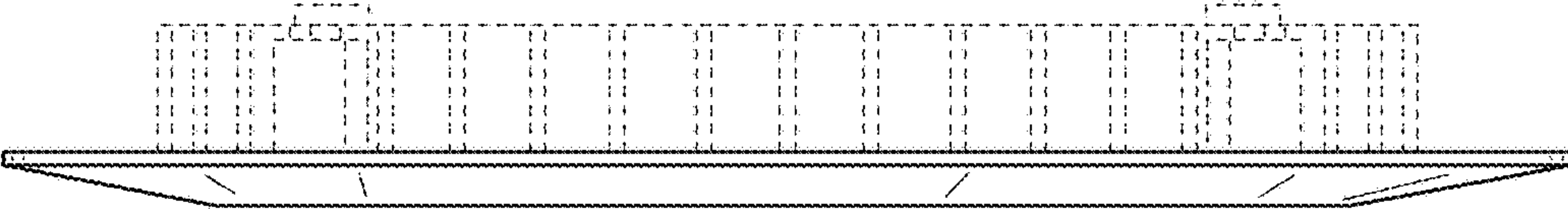

FIG.3

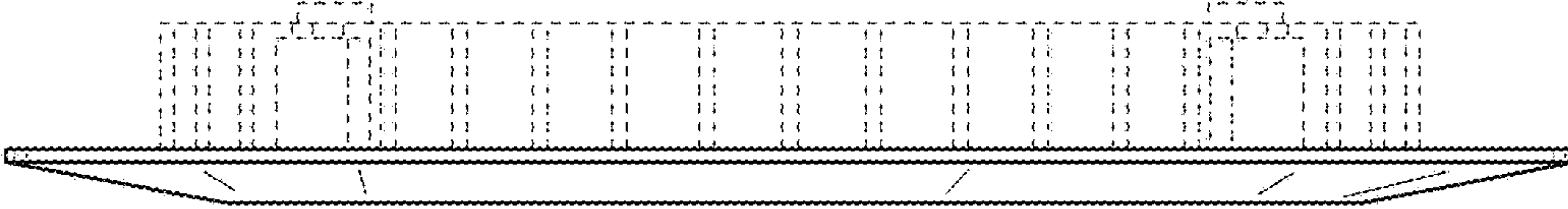

FIG.4

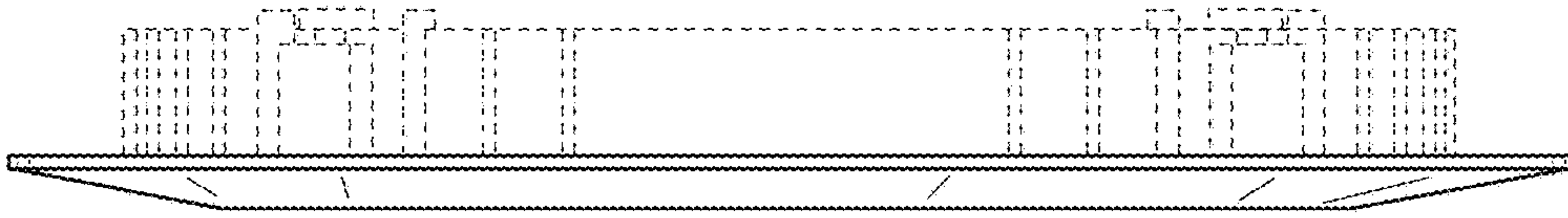

FIG.5

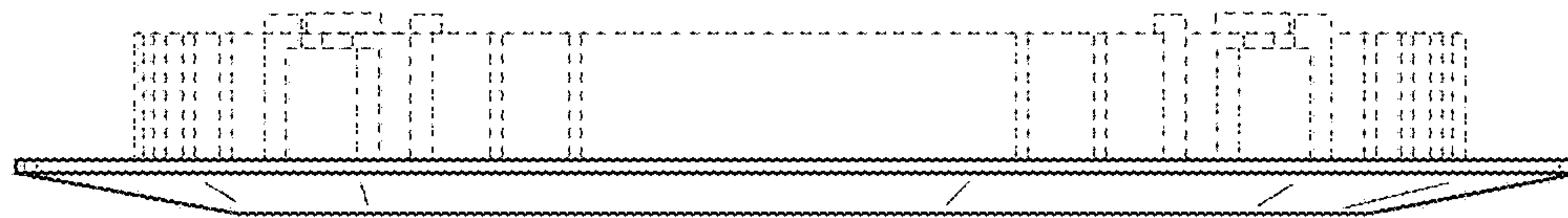

FIG.6

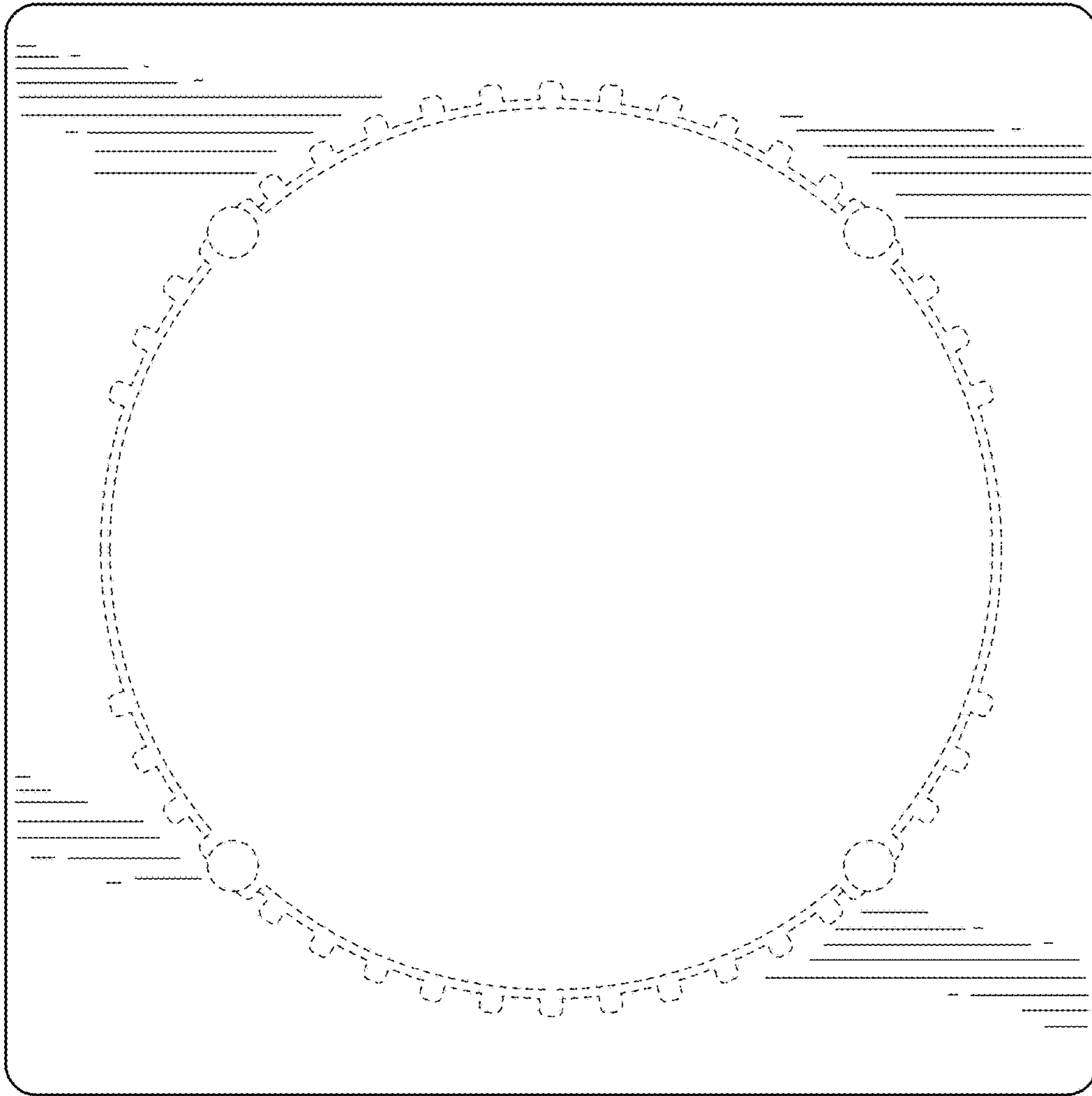

FIG. 7

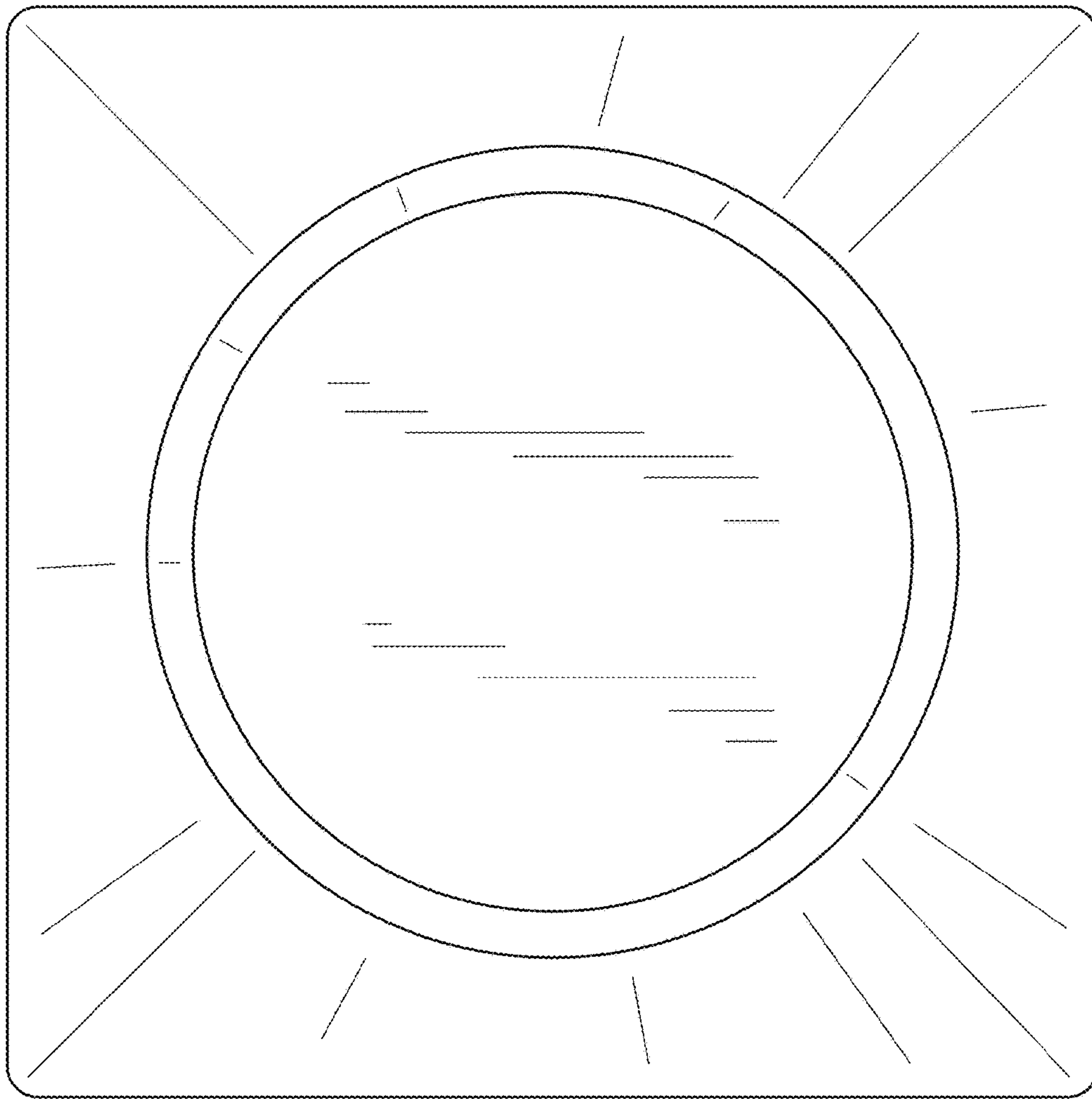

FIG.8