



US00D829215S

(12) **United States Design Patent**
Magargee et al.

(10) **Patent No.:** **US D829,215 S**

(45) **Date of Patent:** **** Sep. 25, 2018**

(54) **STAND**

(71) Applicant: **3M INNOVATIVE PROPERTIES COMPANY**, St. Paul, MN (US)

(72) Inventors: **James K. Magargee**, New Brighton, MN (US); **David J. Prince**, St. Paul, MN (US); **Yin C. Quintero**, St. Paul, MN (US); **Jason S. Lind**, Woodbury, MN (US); **Alonso M. Hernandez**, St. Paul, MN (US)

(73) Assignee: **3M INNOVATIVE PROPERTIES COMPANY**, St. Paul, MN (US)

(**) Term: **15 Years**

(21) Appl. No.: **29/590,056**

(22) Filed: **Jan. 6, 2017**

(51) **LOC (11) Cl.** **08-07**

(52) **U.S. Cl.**
USPC **D14/447**

(58) **Field of Classification Search**
USPC D14/447, 432, 434, 439, 440, 451, 452, D14/457, 239; D8/363, 373, 380; D6/406.3, 406.4, 406.5, 406.6; D12/415
CPC A47B 21/04; A47B 2097/006; A47B 2097/005; A47B 2023/049; A45C 2011/002; A45C 2011/003; F16M 2200/00; F16M 13/00
See application file for complete search history.

(56) **References Cited**

U.S. PATENT DOCUMENTS

D344,076 S * 2/1994 Zahabi D14/447
D483,767 S 12/2003 Green

D558,774 S * 1/2008 Najima D14/447
D559,850 S 1/2008 Lye
D573,150 S * 7/2008 Sween D14/447
D591,303 S * 4/2009 Heggland D14/434
D645,865 S * 9/2011 Diehl D14/299
D676,853 S * 2/2013 Gengler D14/447
D694,248 S * 11/2013 Van Natta D14/447
D733,155 S * 6/2015 van Hooft D14/447
D786,883 S * 5/2017 Chen D14/447
D788,780 S * 6/2017 Chen D14/447
D788,781 S * 6/2017 Chen D14/447
D798,871 S * 10/2017 Avganim D14/447
D804,490 S * 12/2017 Wei D14/447

* cited by examiner

Primary Examiner — Angela J Lee

(74) *Attorney, Agent, or Firm* — Irina Hass

(57) **CLAIM**

The ornamental design for a stand, as shown and described.

DESCRIPTION

FIG. 1 is a perspective view showing the new design for a stand;
FIG. 2 is a front view thereof;
FIG. 3 is a rear view thereof;
FIG. 4 is a left side view thereof;
FIG. 5 is a right side view thereof;
FIG. 6 is a top view thereof; and,
FIG. 7 is a bottom view thereof.
The broken lines shown in the drawings represent portions of the stand that form no part of the claimed design.

1 Claim, 5 Drawing Sheets

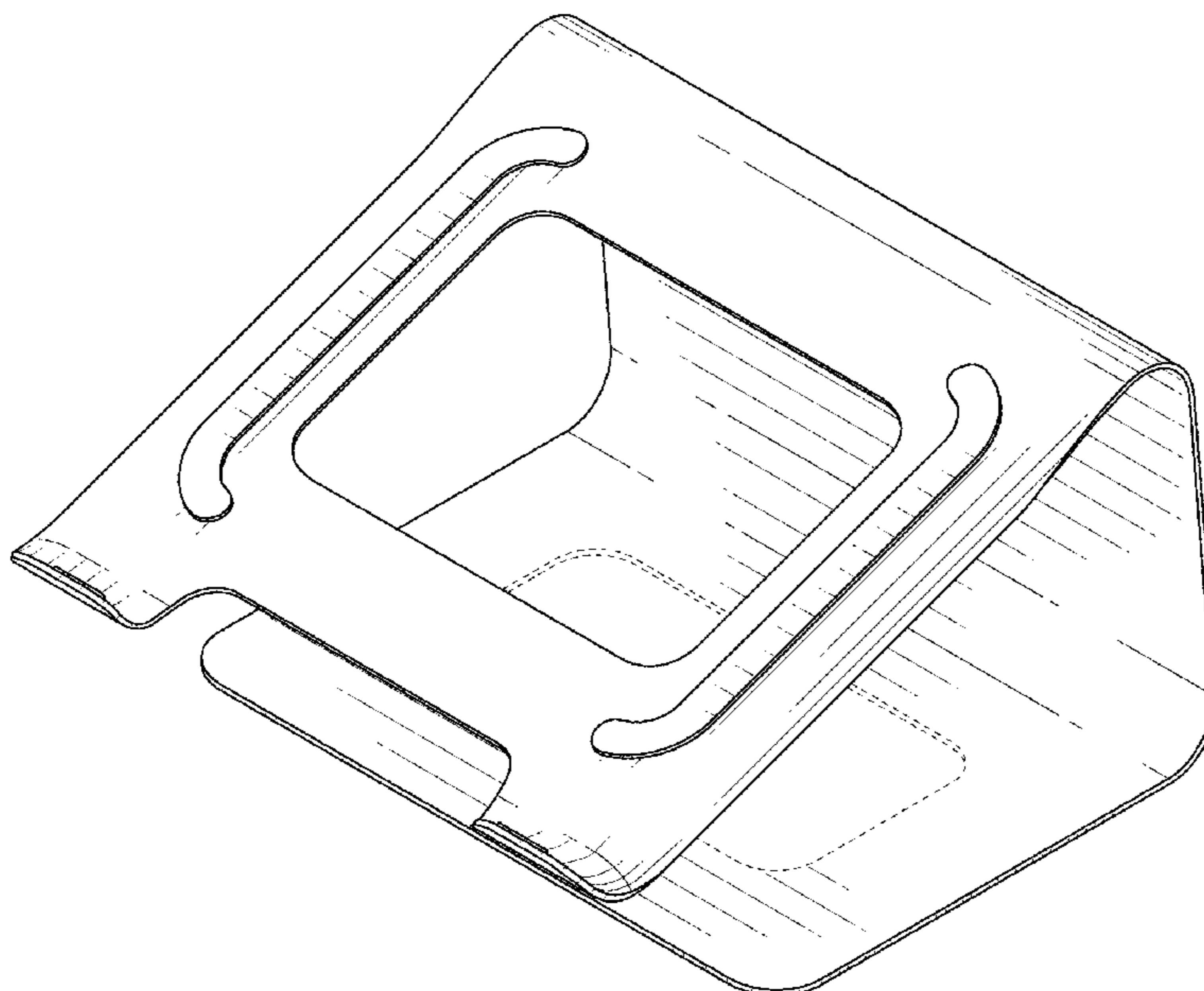

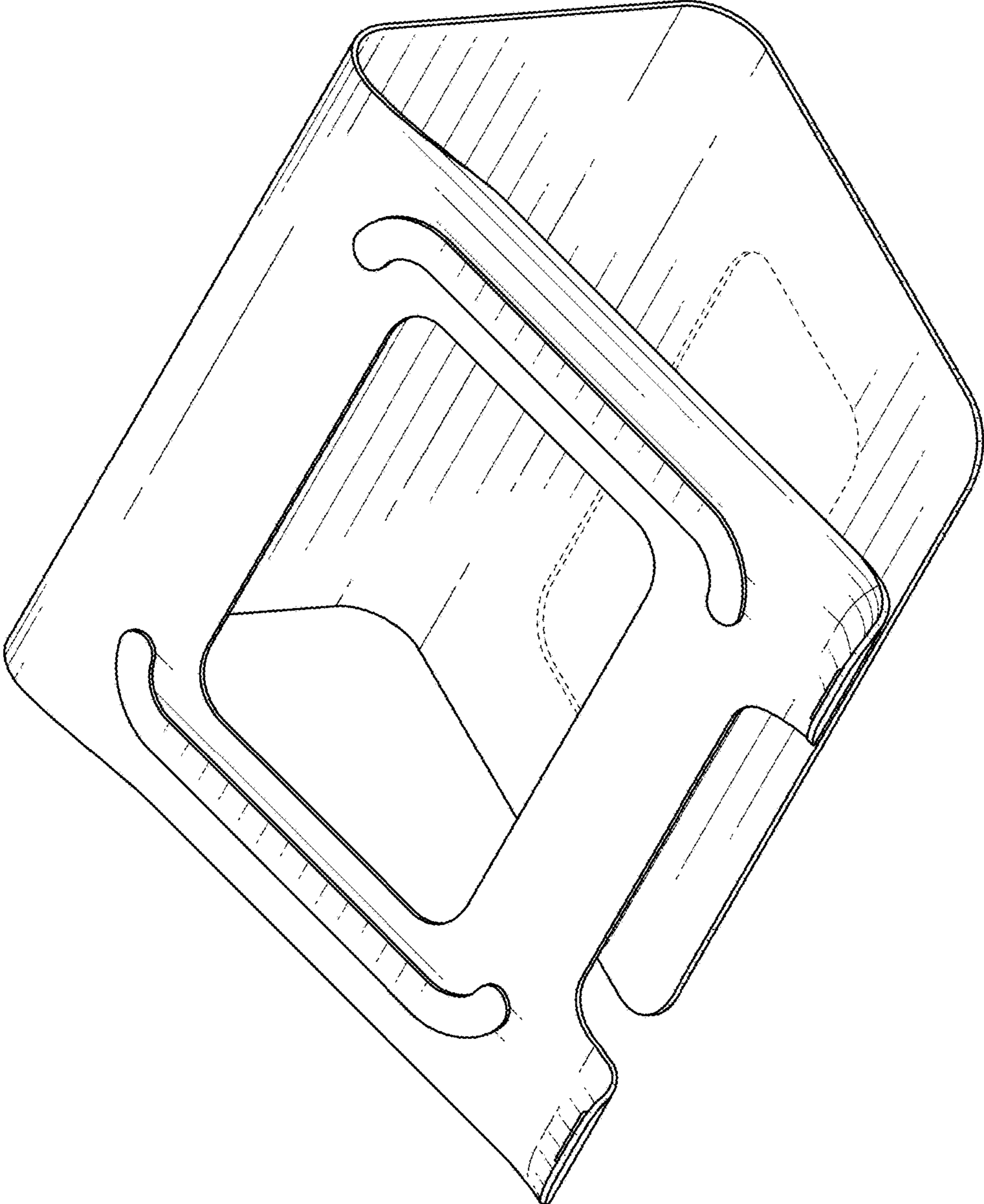

FIG. 1

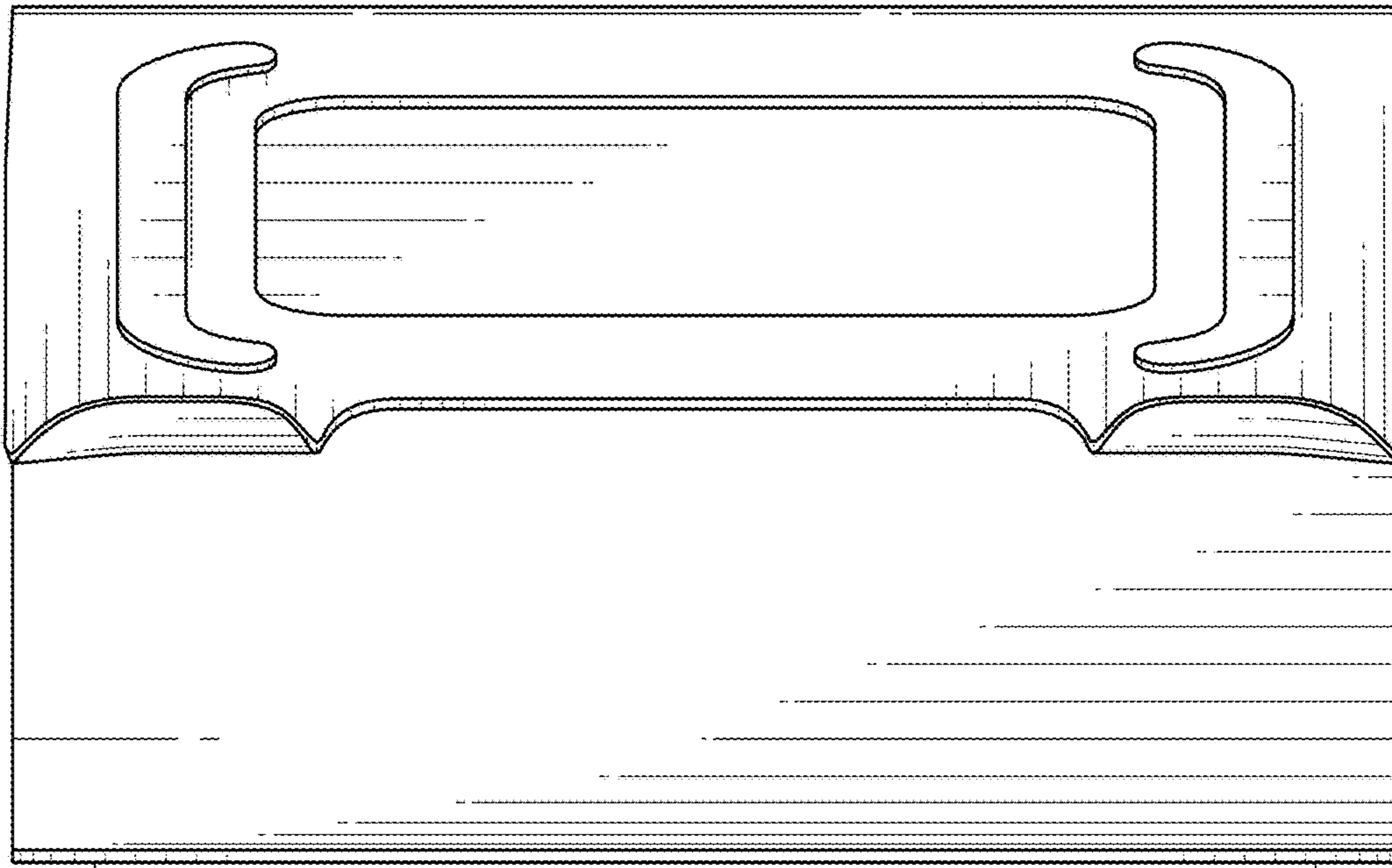

FIG. 2

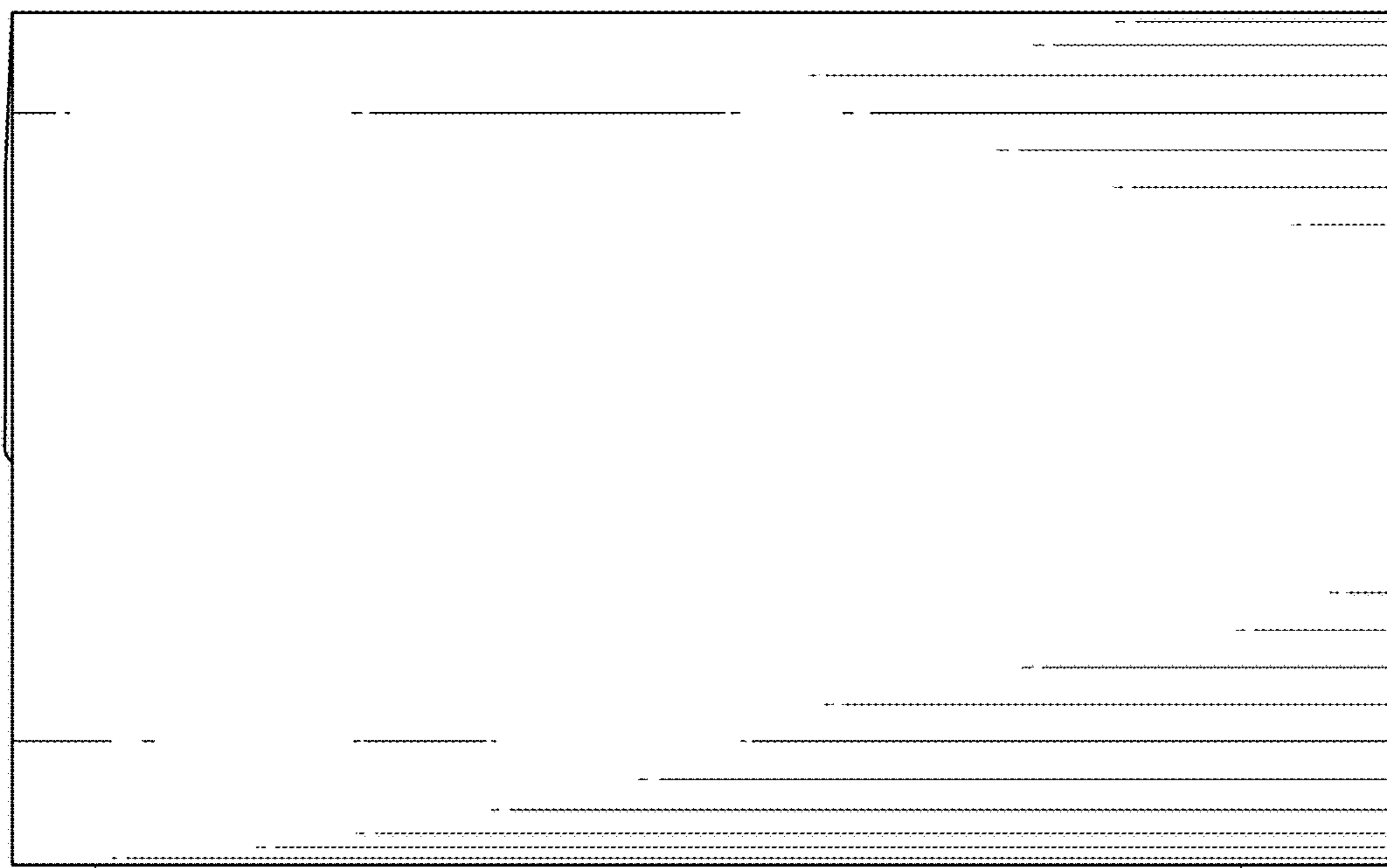

FIG. 3

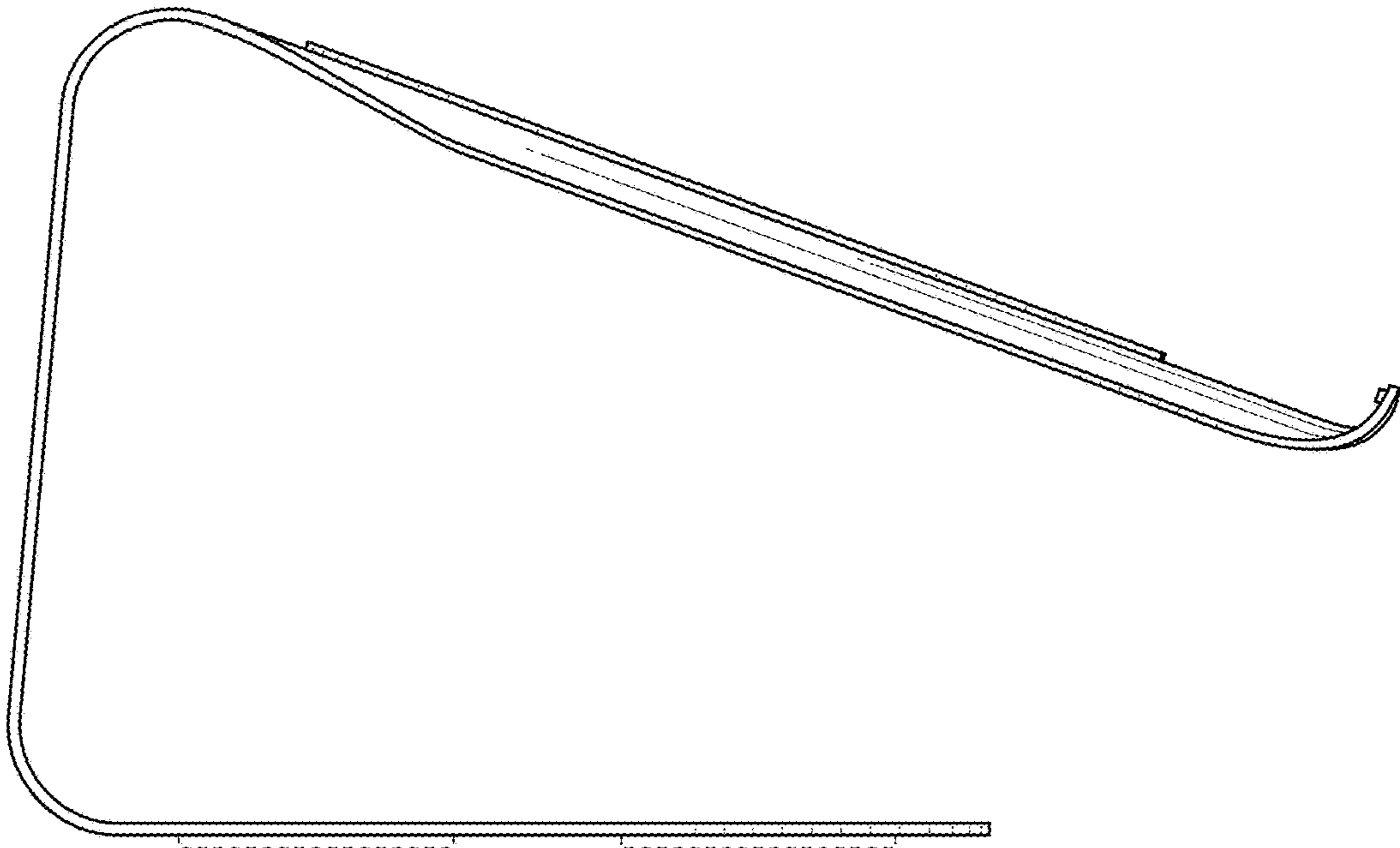

FIG. 4

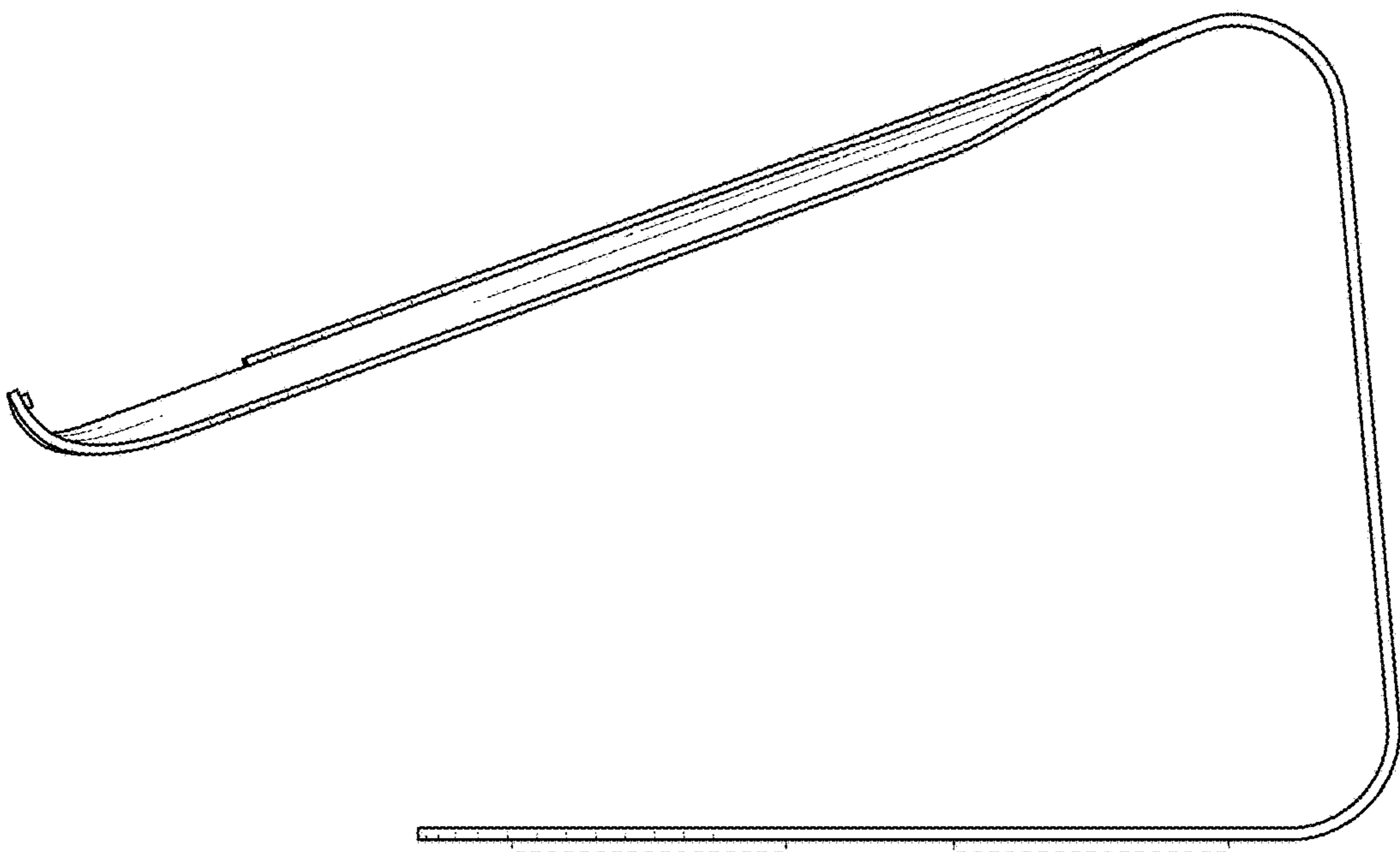

FIG. 5

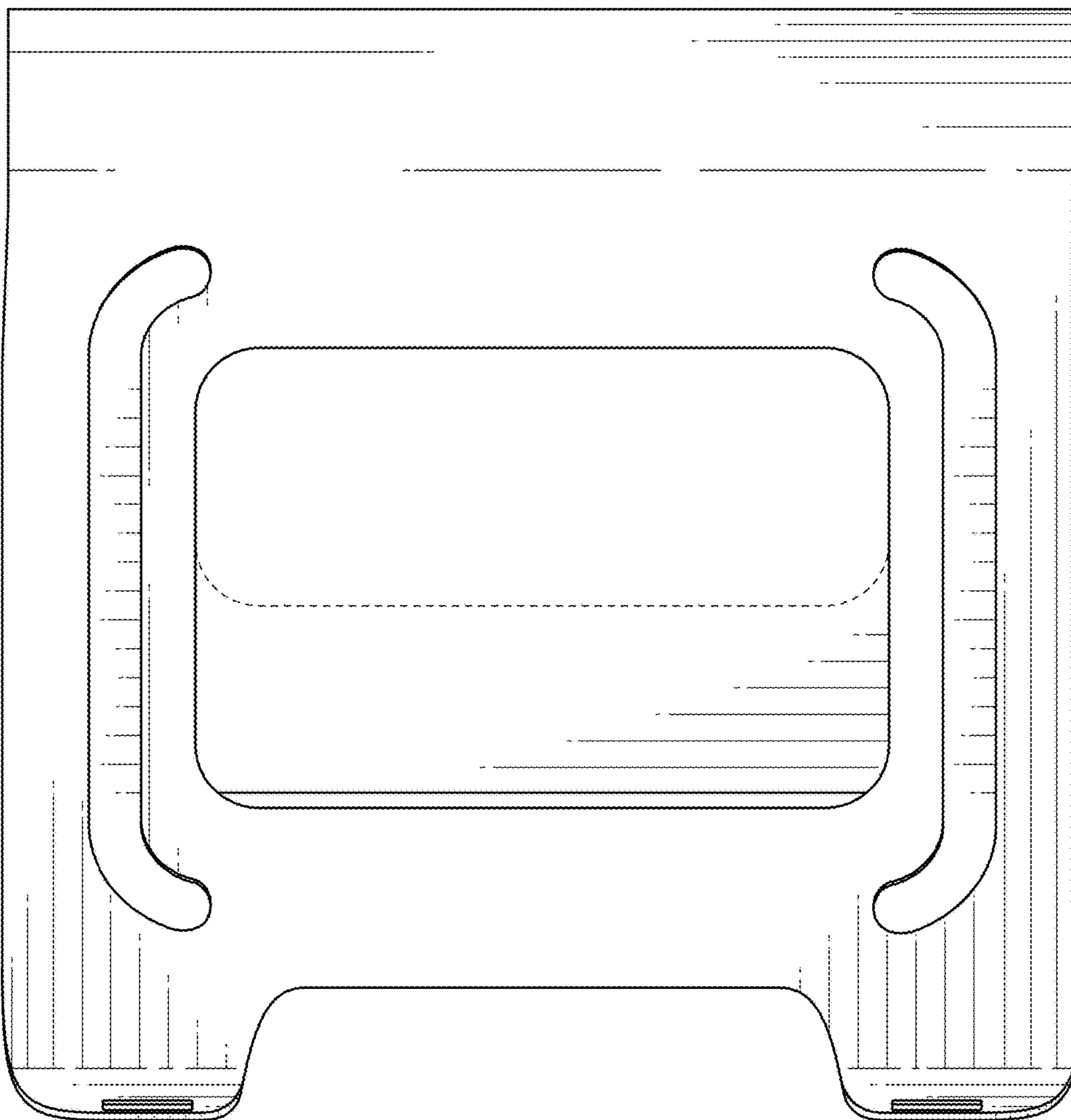

FIG. 6

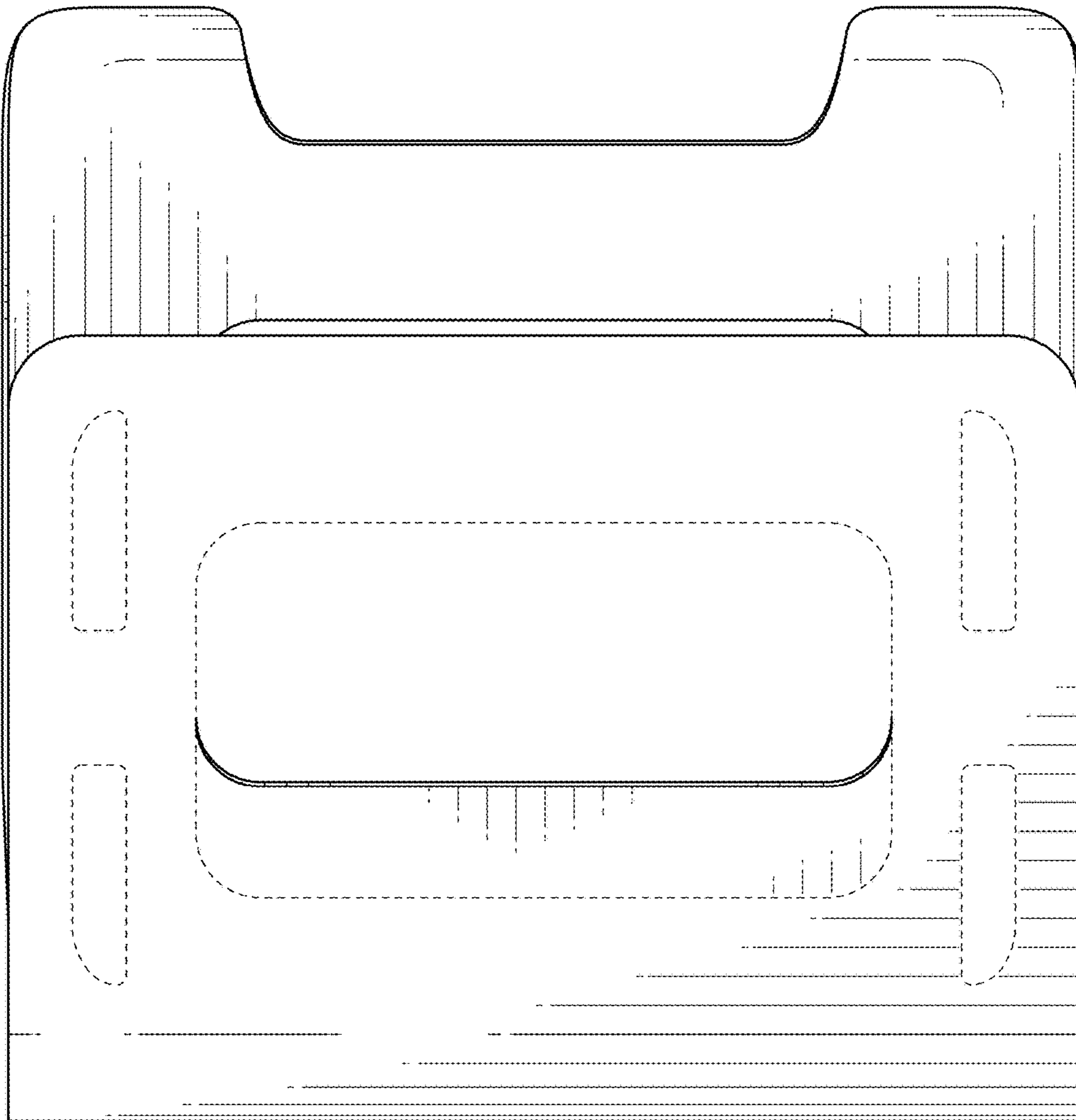

FIG. 7