



US00D829183S

(12) **United States Design Patent** (10) **Patent No.:** **US D829,183 S**  
**Li** (45) **Date of Patent:** **\*\* Sep. 25, 2018**

(54) **GRAPHIC CARD RADIATOR**  
(71) Applicant: **SHENZHEN GAOYU ELECTRONIC TECHNOLOGY CO., LTD.**, Shenzhen (CN)

D604,704 S \* 11/2009 Jung ..... D13/179  
D694,199 S \* 11/2013 Lin ..... D13/179  
D696,764 S \* 12/2013 Sato ..... D13/179  
D701,179 S \* 3/2014 Kim ..... D13/179  
D732,655 S \* 6/2015 Ueno ..... D13/179  
2011/0100612 A1\* 5/2011 Tang ..... G06F 1/20  
165/104.33

(72) Inventor: **Shunhui Li**, Shenzhen (CN)  
(73) Assignee: **SHENZHEN GAOYU ELECTRONIC TECHNOLOGY CO., LTD.**, Shenzhen (CN)

(Continued)

(\*\*) Term: **15 Years**

(21) Appl. No.: **29/610,591**

(22) Filed: **Jul. 13, 2017**

(30) **Foreign Application Priority Data**

Jun. 15, 2017 (CN) ..... 2017 3 0245419

(51) **LOC (11) Cl.** ..... **13-03**

(52) **U.S. Cl.**  
USPC ..... **D13/179**

(58) **Field of Classification Search**  
USPC ..... D13/179, 122, 182; D23/379, 380  
CPC .. H05K 7/20; H05K 7/20172; H05K 7/20127;  
H05K 7/20336; H05K 7/202; H05K  
7/20272; H01L 23/34; H01L 23/3672;  
H01L 23/40; H01L 23/4006; H01L  
23/4093; F28D 15/0208; F28D 15/04  
See application file for complete search history.

(56) **References Cited**

**U.S. PATENT DOCUMENTS**

D398,977 S \* 9/1998 Horng ..... D13/179  
D465,771 S \* 11/2002 Hsieh ..... D13/179  
D466,092 S \* 11/2002 Hsieh ..... D13/179  
D478,876 S \* 8/2003 Tan ..... D13/179  
D511,327 S \* 11/2005 Ma ..... D13/179  
D570,472 S \* 6/2008 Otsuki ..... D23/413  
D576,963 S \* 9/2008 Mochizuki ..... D13/179

**OTHER PUBLICATIONS**

Amazon, "ASUS STRIX GeForce GTX 980 Overclocked 4 GB DDRS 256-bit DisplayPort HDMI 2.0 DVI-I Graphics Card", first on sale Oct. 3, 2014. (<https://www.amazon.com/GeForce-Overclocked-256-bit-DisplayPort-Graphics/dp/B00O4S9NY8>).\*

(Continued)

*Primary Examiner* — Jennifer Rivard

*Assistant Examiner* — April Rivas

(74) *Attorney, Agent, or Firm* — Hemisphere Law, PLLC; Zhigang Ma

(57) **CLAIM**

The ornamental design for a graphic card radiator, as shown and described.

**DESCRIPTION**

FIG. 1 is a perspective view of a graphic card radiator, showing my new design;  
FIG. 2 is a bottom perspective view thereof;  
FIG. 3 is a front view thereof;  
FIG. 4 is a rear view thereof;  
FIG. 5 is a left side view thereof;  
FIG. 6 is a right side view thereof;  
FIG. 7 is a top plan view thereof; and,  
FIG. 8 is a bottom plan view thereof.  
The broken lines shown are included for the purpose of illustrating portions of the graphic card radiator which form no part of the claimed design.

**1 Claim, 4 Drawing Sheets**

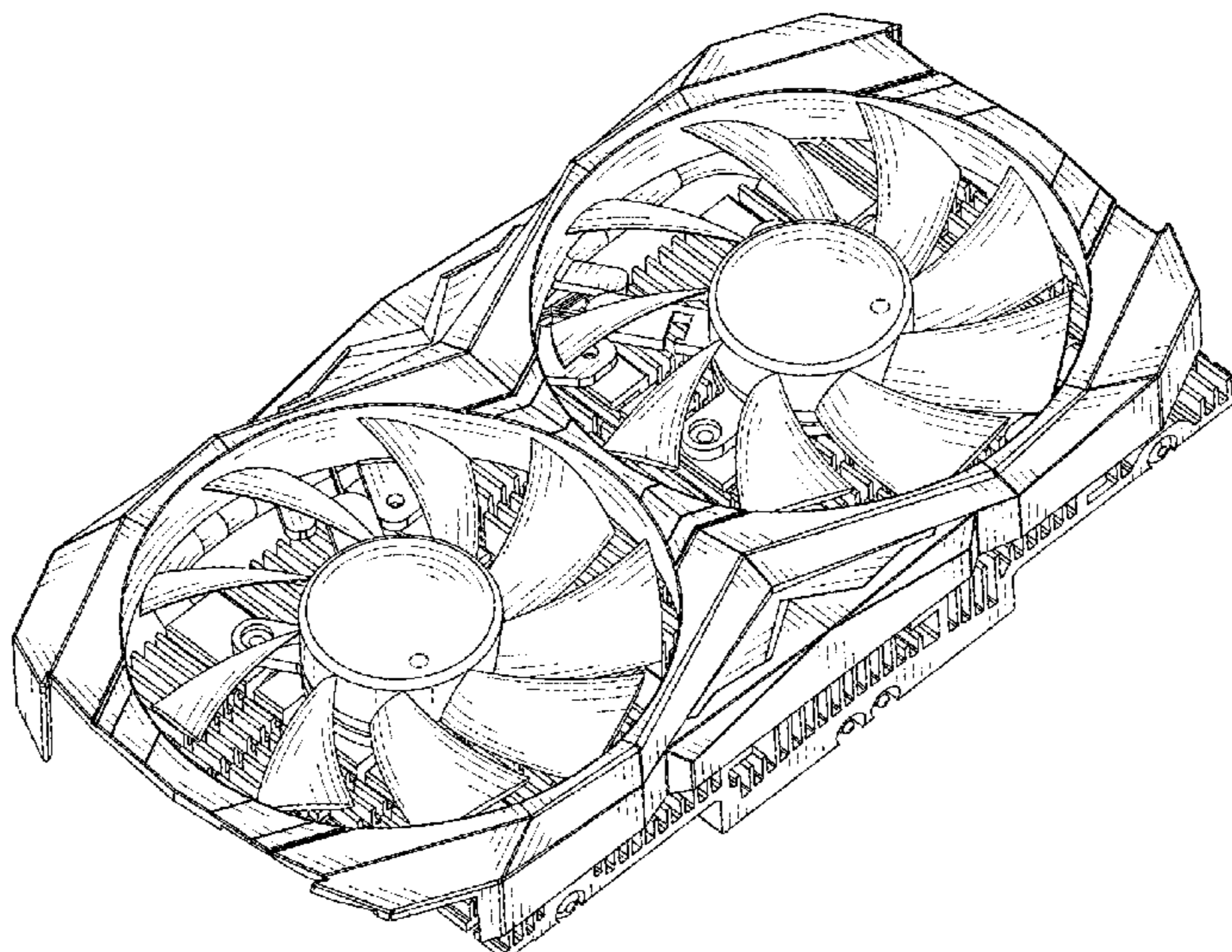

(56)

**References Cited**

U.S. PATENT DOCUMENTS

2017/0347488 A1\* 11/2017 Wu ..... H05K 7/20136  
2017/0359920 A1\* 12/2017 Huang ..... G06F 1/186

OTHER PUBLICATIONS

Amazon, "XFX Radeon RX 580 GTS XXX Edition 1386MHz OC+, 8GB GDDRS, VR Ready, Dual BIOS, 3xDP HDMI DVI, AMD Graphics Card (RX-580P8DFD6)", first on sale Apr. 18, 2017. (<https://www.amazon.com/dp/B06Y66K3XD/>).\*

\* cited by examiner



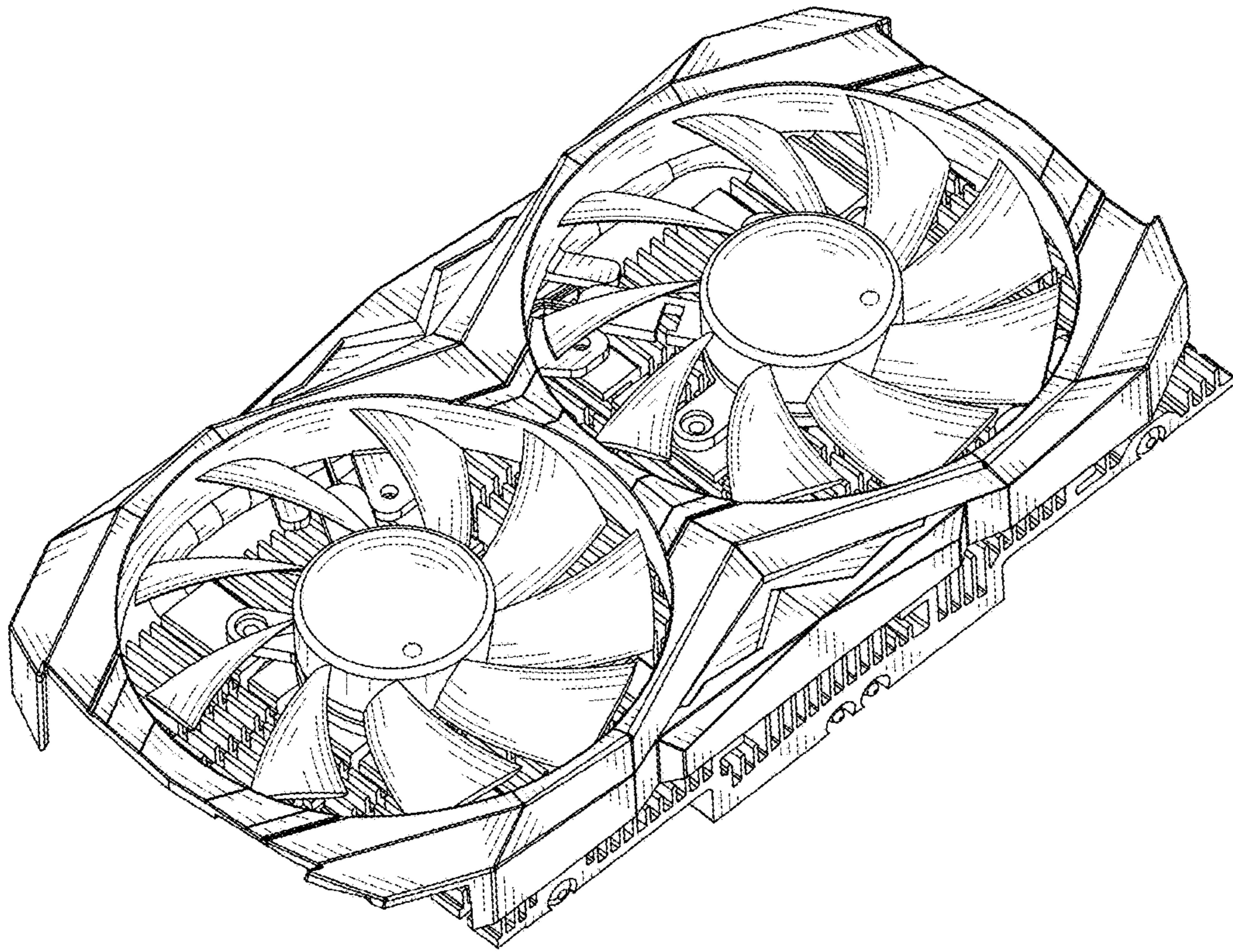

FIG. 1

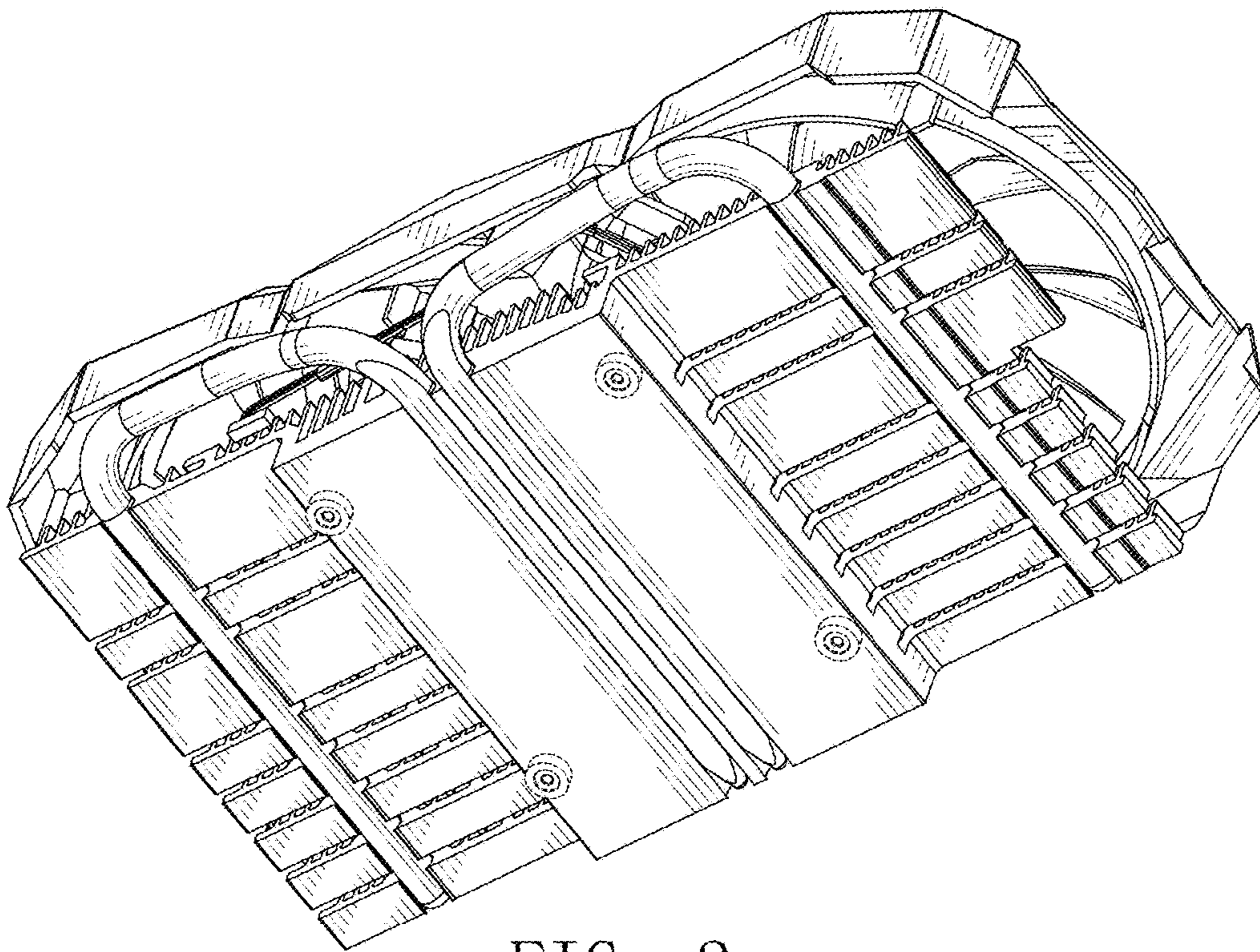

FIG. 2



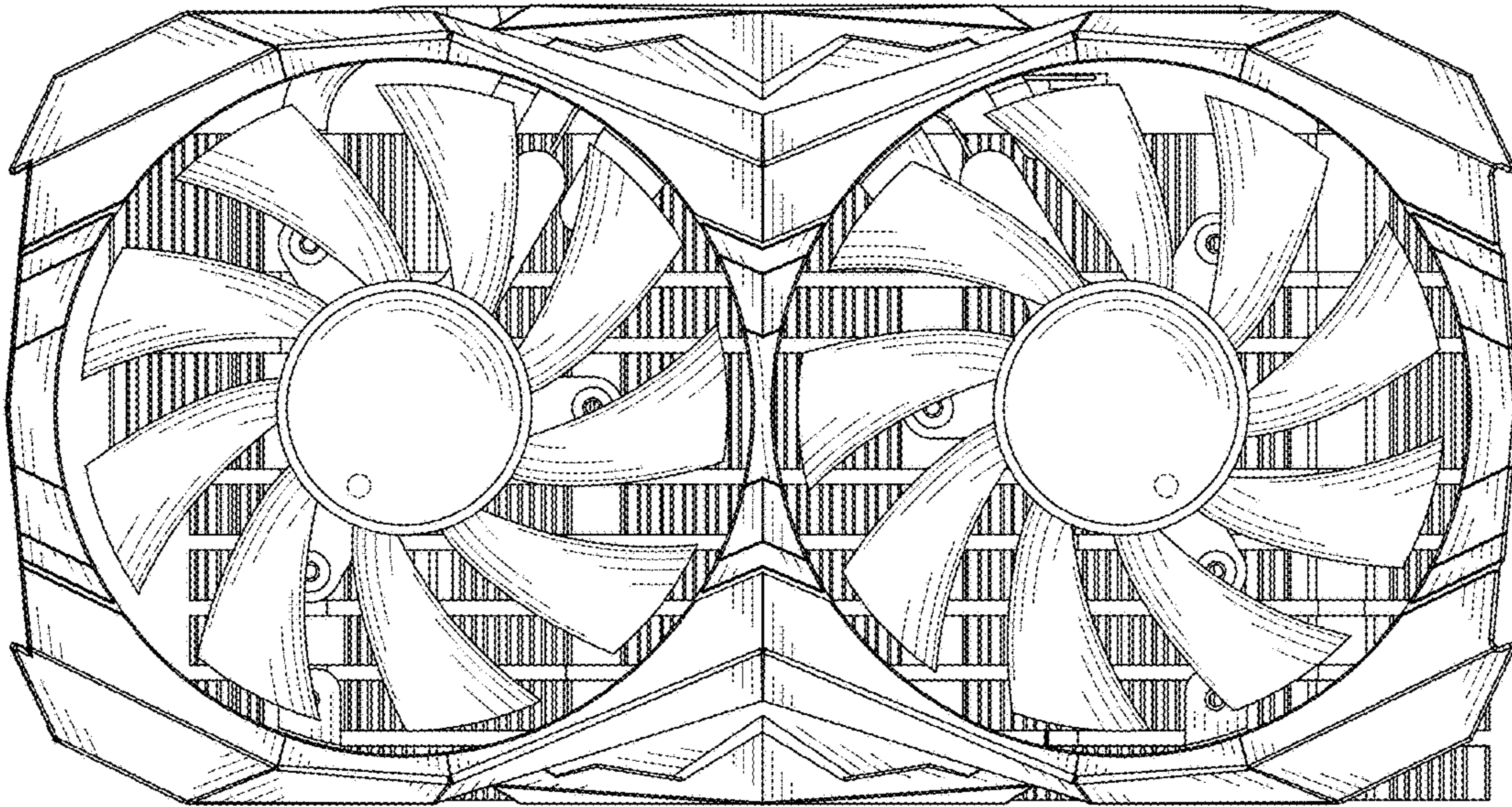

FIG. 3

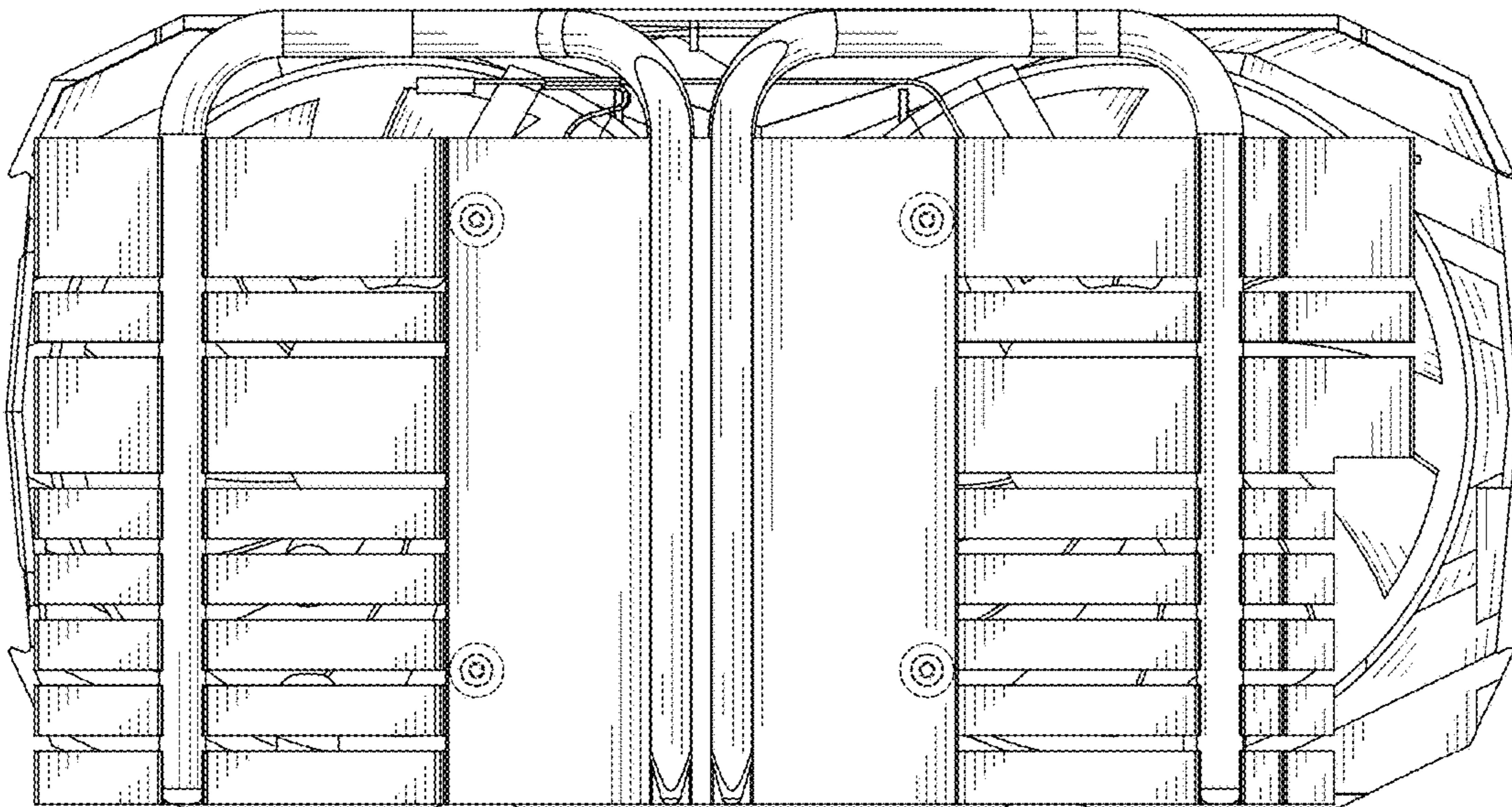

FIG. 4

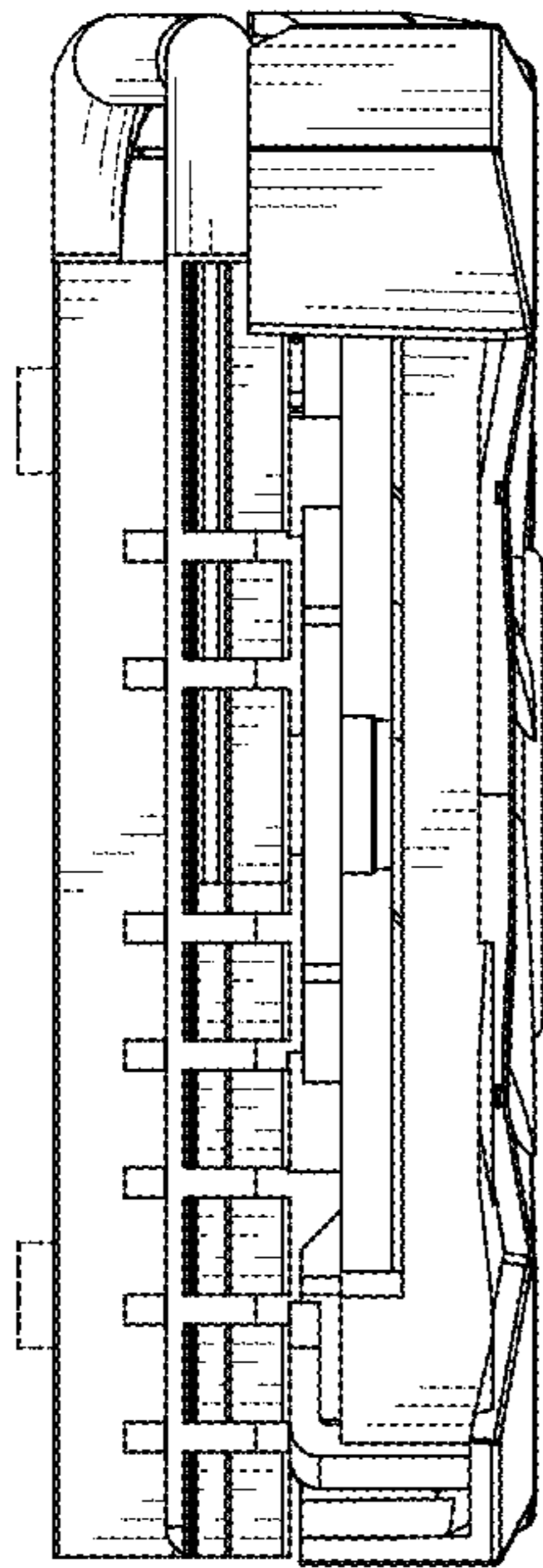

FIG. 5

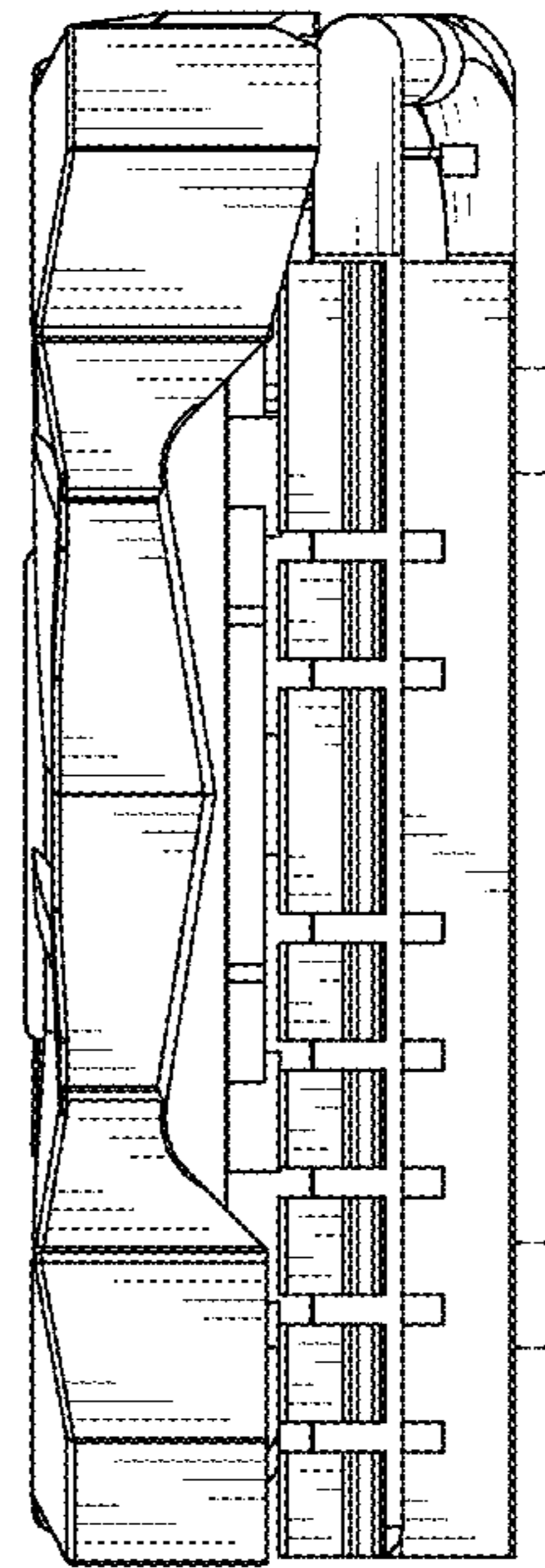

FIG. 6

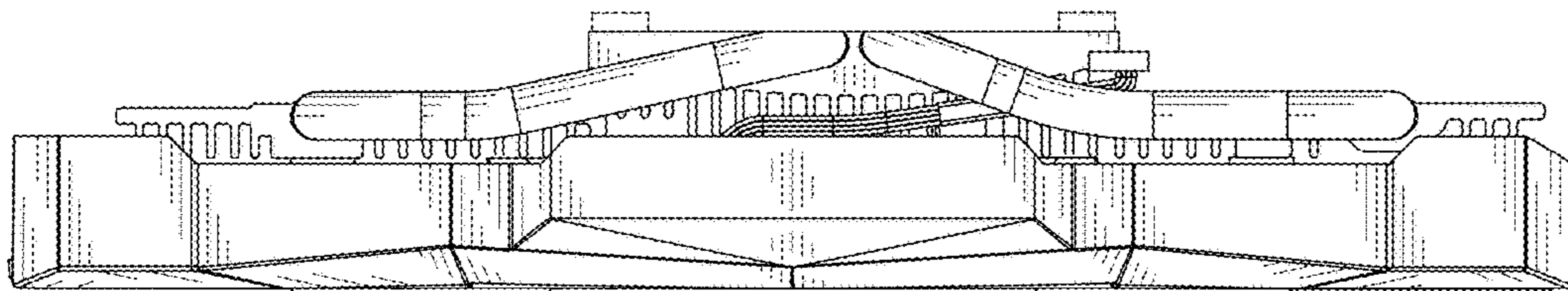

FIG. 7

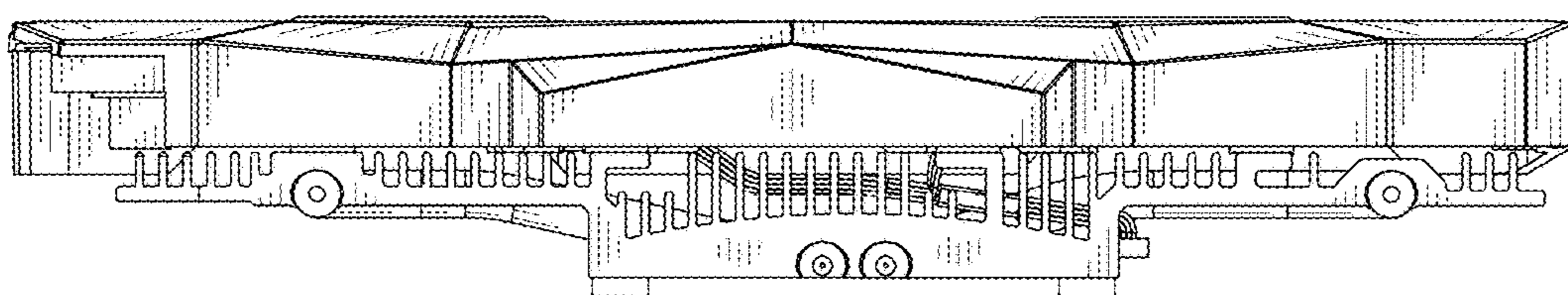

FIG. 8