



US00D829116S

(12) **United States Design Patent** (10) **Patent No.:** **US D829,116 S**  
**Hirose et al.** (45) **Date of Patent:** **\*\* Sep. 25, 2018**

(54) **SPECTROMETER**

(56) **References Cited**

(71) Applicant: **HAMAMATSU PHOTONICS K.K.**,  
Shizuoka (JP)  
(72) Inventors: **Masaki Hirose**, Hamamatsu (JP);  
**Katsumi Shibayama**, Hamamatsu (JP);  
**Takashi Kasahara**, Hamamatsu (JP);  
**Toshimitsu Kawai**, Hamamatsu (JP);  
**Hiroki Oyama**, Hamamatsu (JP); **Yumi**  
**Teramachi**, Hamamatsu (JP); **Takafumi**  
**Yokino**, Hamamatsu (JP); **Katsuhiko**  
**Kato**, Hamamatsu (JP)

U.S. PATENT DOCUMENTS

6,686,998 B2 \* 2/2004 Gianchandani ..... G01N 21/67  
313/163  
D603,280 S \* 11/2009 Shibayama ..... D10/81  
D603,729 S \* 11/2009 Shibayama ..... D10/81  
D603,730 S \* 11/2009 Shibayama ..... D10/81  
D603,731 S \* 11/2009 Shibayama ..... D10/81  
D730,217 S \* 5/2015 Yokino ..... D10/81  
D733,599 S \* 7/2015 Yokino ..... D10/81  
D744,878 S \* 12/2015 Yokino ..... D10/46  
9,746,616 B2 \* 8/2017 Ko ..... G01J 3/0256

\* cited by examiner

*Primary Examiner* — George D. Kirschbaum

(\*\*) Term: **15 Years**

(57) **CLAIM**

(21) Appl. No.: **35/503,183**

The ornamental design for a spectrometer, as shown and described.

(22) Filed: **Dec. 13, 2016**

**DESCRIPTION**

(80) **Hague Agreement Data**

Int. Filing Date: **Dec. 13, 2016**  
Int. Reg. No.: **DM/093917**  
Int. Reg. Date: **Dec. 13, 2016**  
Int. Reg. Pub. Date: **Jun. 16, 2017**

1. Spectrometer  
1.1 : Front perspective view  
1.2 : Back perspective view  
1.3 : Front  
1.4 : Back  
1.5 : Top  
1.6 : Bottom  
1.7 : Left  
1.8 : Right  
1.9 : Partial enlarged cross-sectional view  
1.10 : Partial enlarged back view  
1.11 : Partial enlarged back perspective view  
The broken line showing is included for the purpose of illustrating portions of the “article” and forms no part of the claimed design.

(30) **Foreign Application Priority Data**

Jun. 14, 2016 (JP) ..... 2016-012704

(51) **LOC (11) Cl.** ..... **10-04**

(52) **U.S. Cl.**  
USPC ..... **D10/81**

(58) **Field of Classification Search**  
USPC ..... D10/81, 47; D13/158, 159, 160  
CPC ..... G01J 3/0256; G01N 21/67  
See application file for complete search history.

**1 Claim, 11 Drawing Sheets**

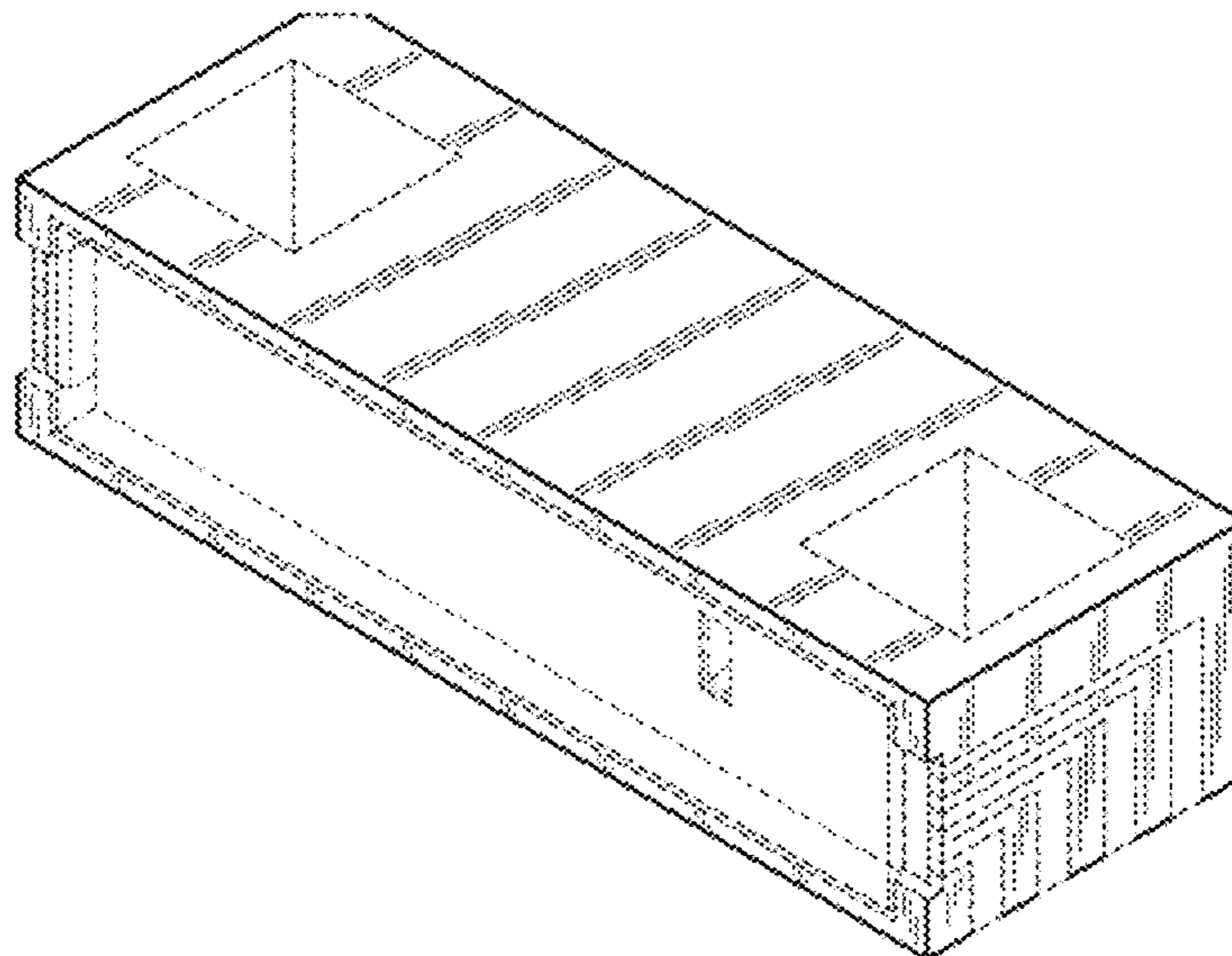

1.1

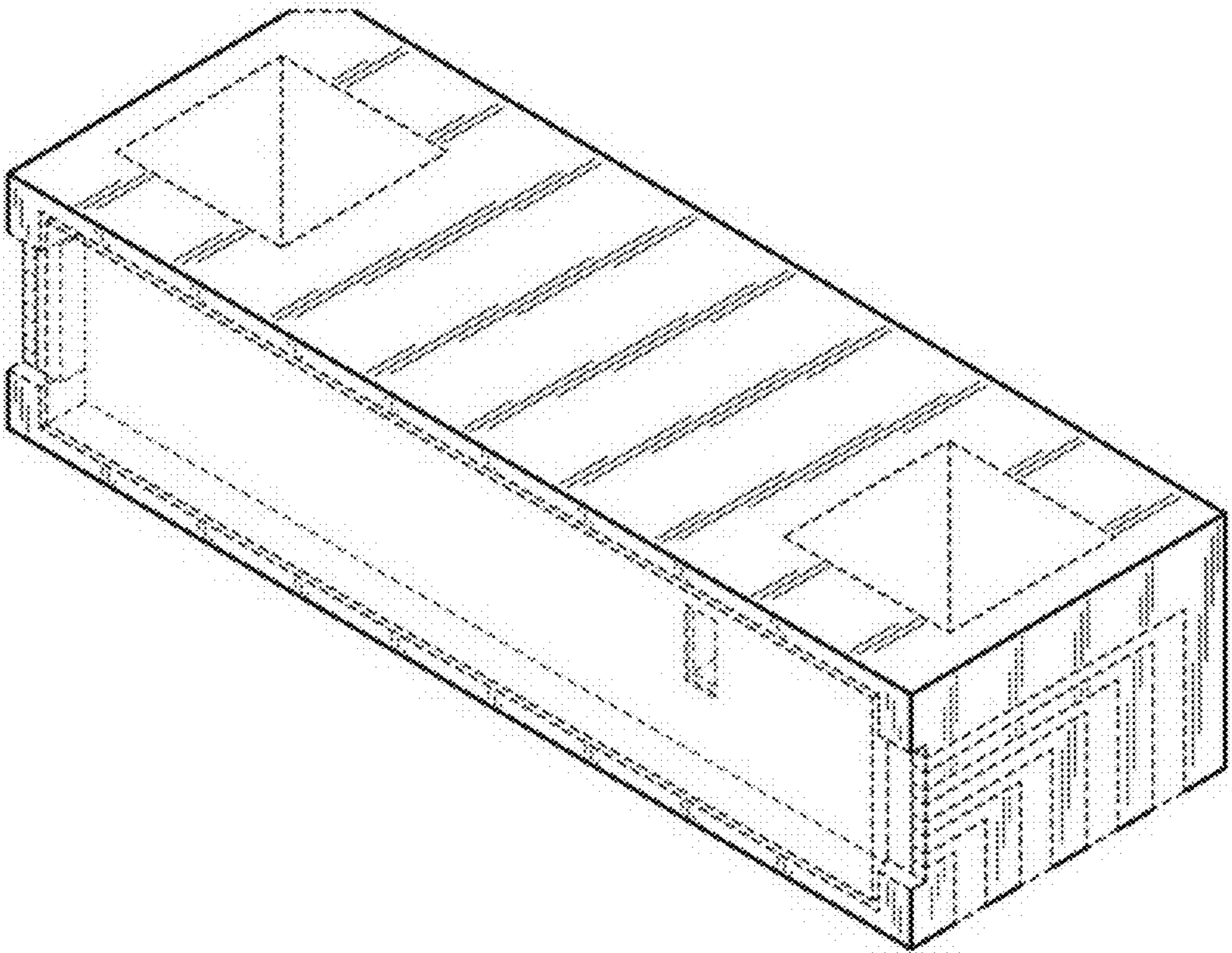

1.2

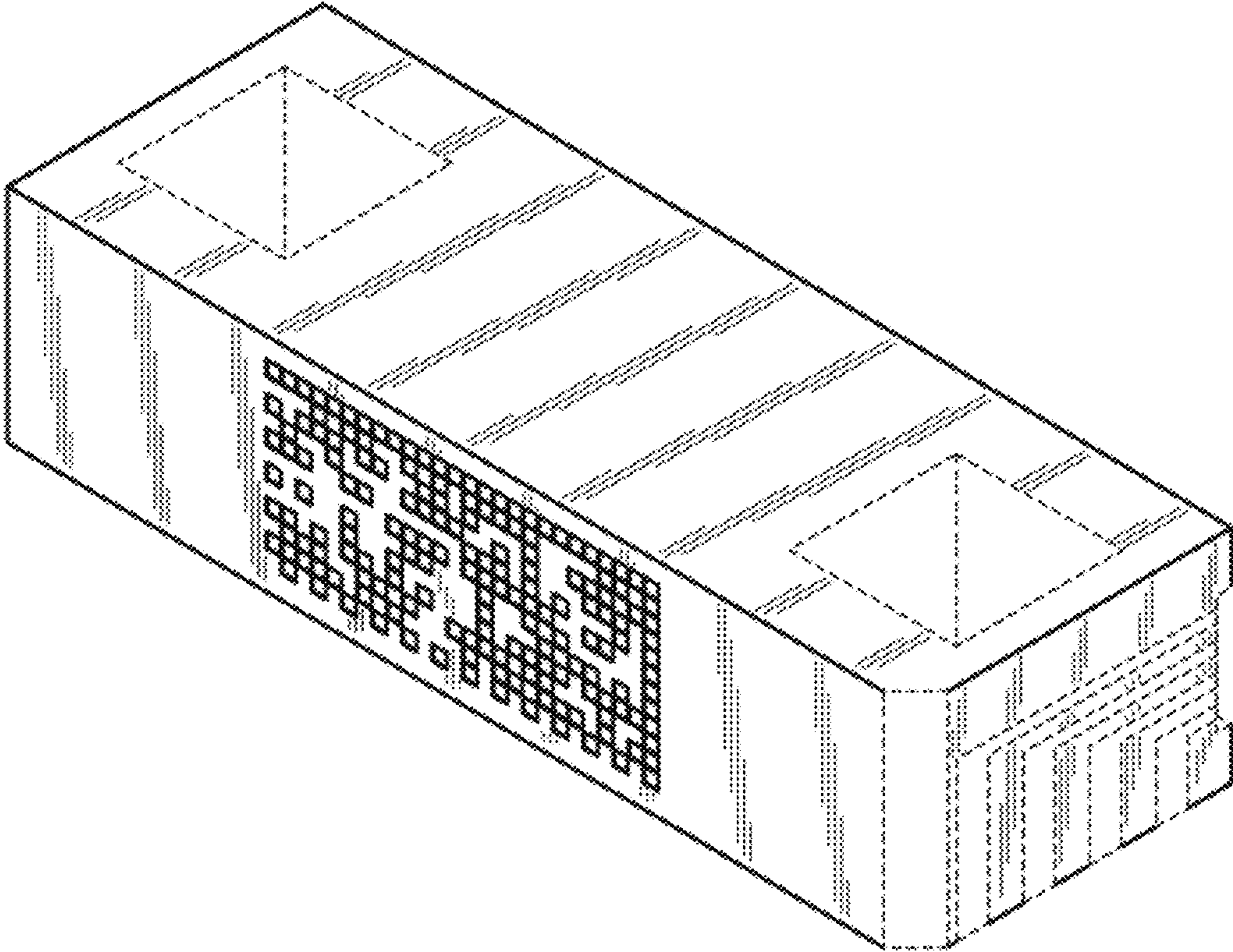

1.3

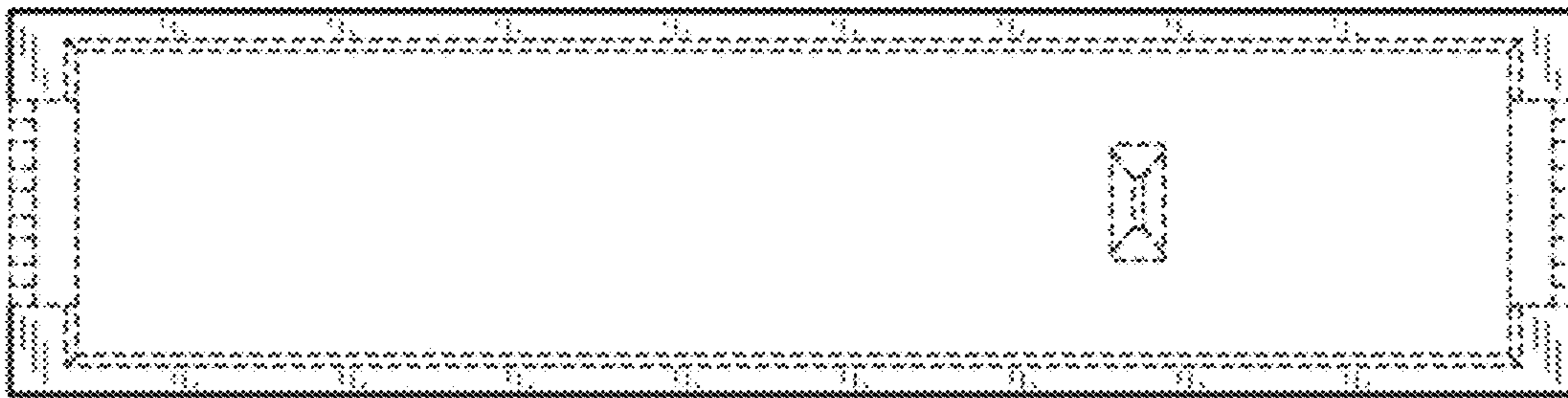



1.4

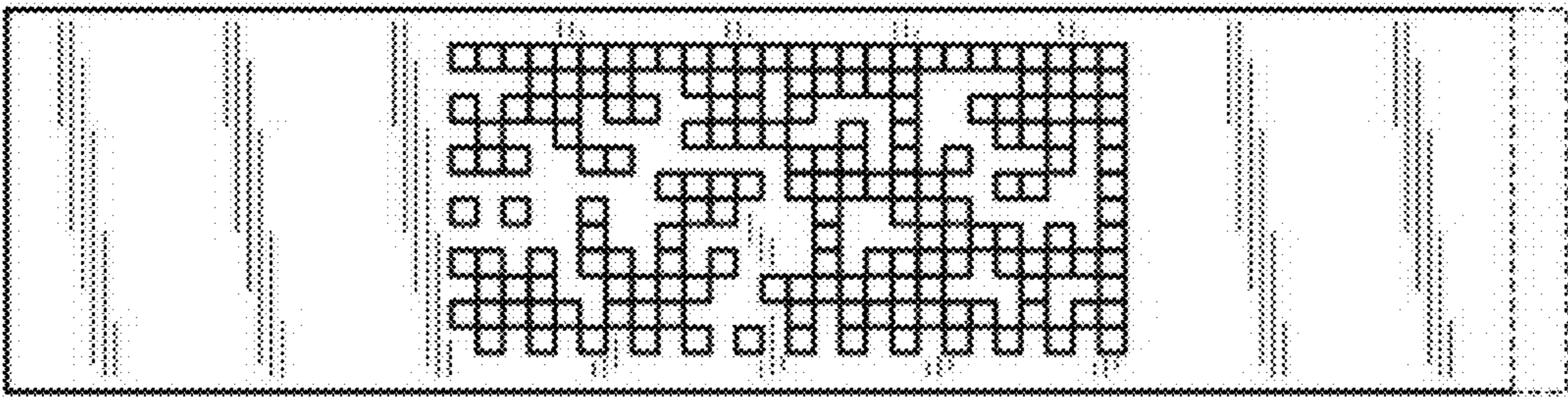

1.5

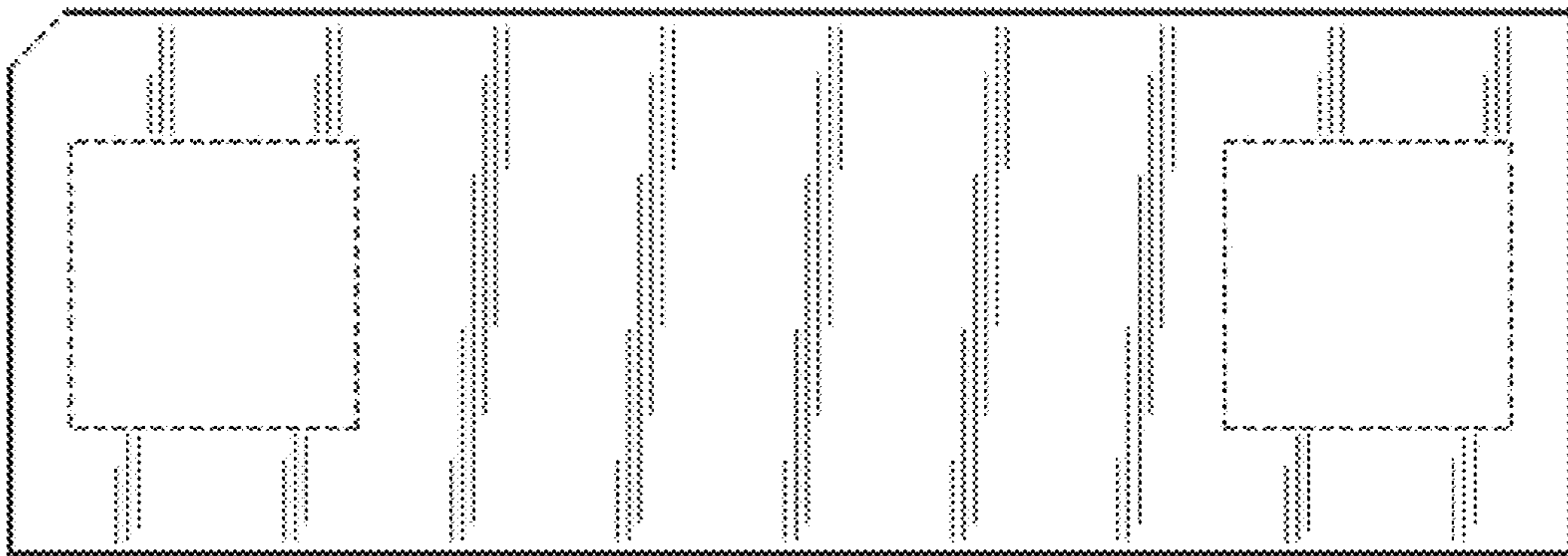

1.6

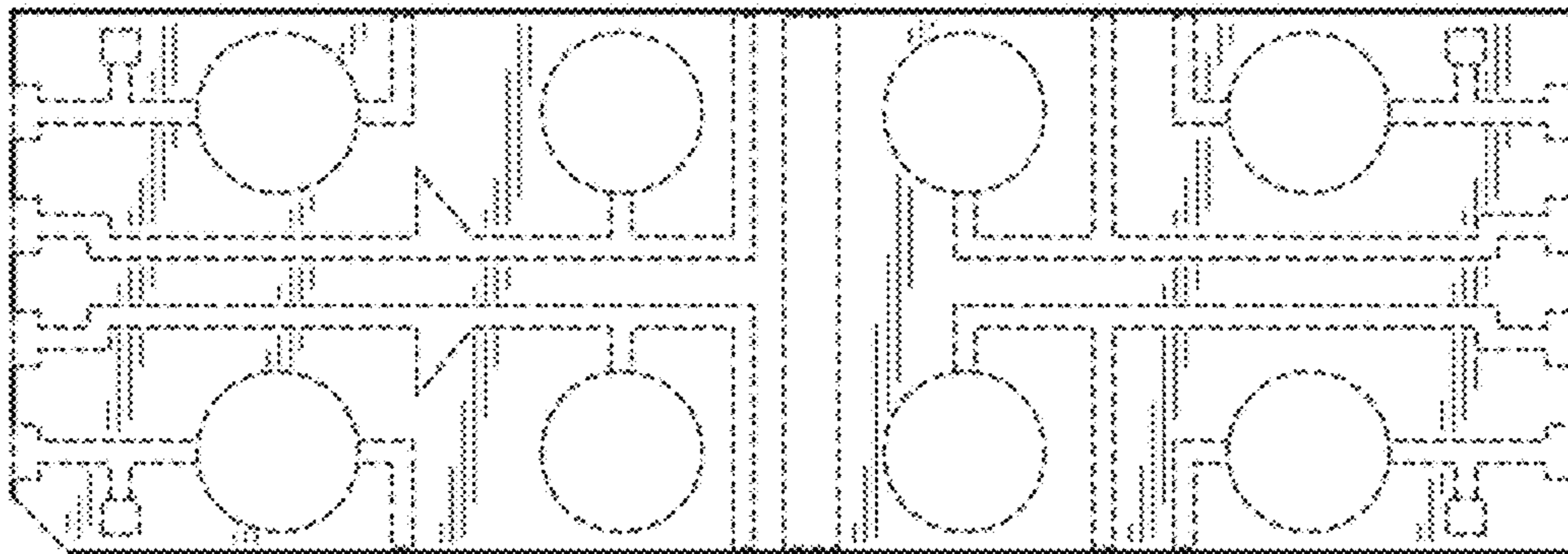

1.7

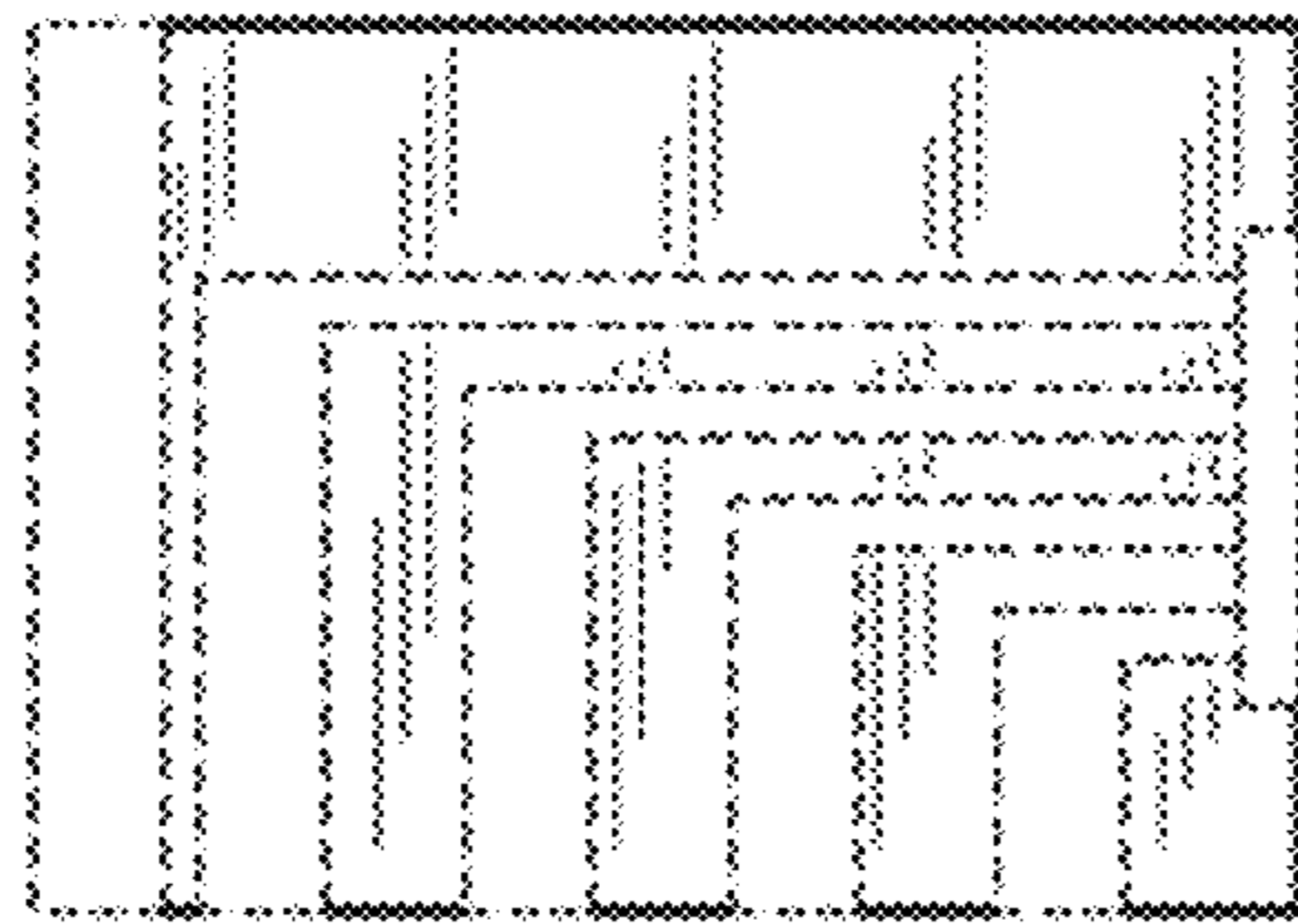



1.8

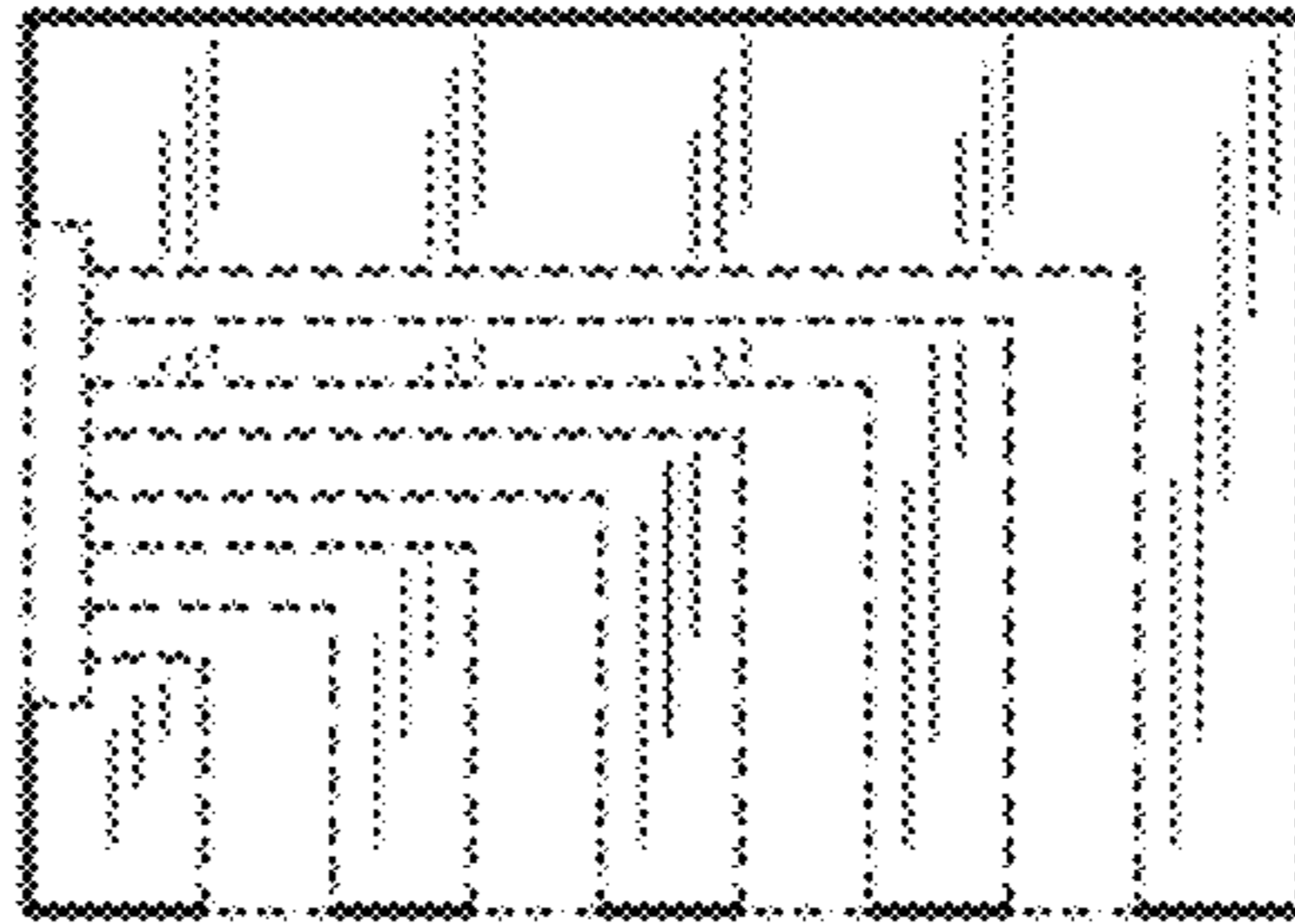

1.9



1.10

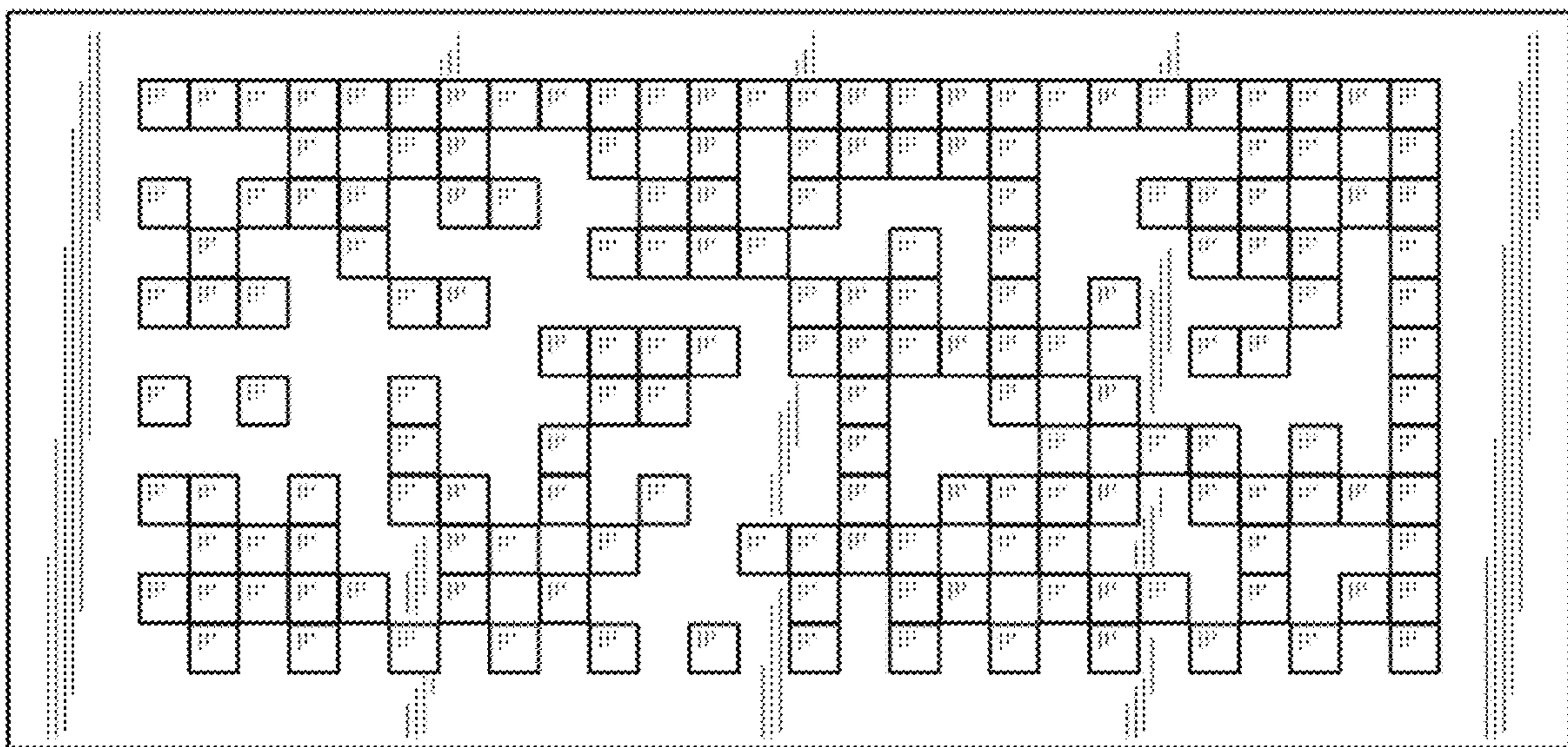

1.11

