



US00D829060S

(12) **United States Design Patent**
Barnard

(10) **Patent No.:** **US D829,060 S**

(45) **Date of Patent:** **** Sep. 25, 2018**

(54) **MICROWAVE OVEN**

FOREIGN PATENT DOCUMENTS

(71) Applicants: **GUANGDONG MIDEA KITCHEN APPLIANCES MANUFACTURING CO., LTD.**, Guangdong (CN); **MIDEA GROUP CO., LTD.**, Guangdong, CA (US)

JP 10253063 A * 9/1998 H05B 6/745

(72) Inventor: **Pierce James Barnard**, Guangdong (CN)

OTHER PUBLICATIONS

Amazon. <URL: [\(73\) Assignees: **GUANGDONG MIDEA KITCHEN APPLIANCES MANUFACTURING CO., LTD.**, Foshan \(CN\); **MIDEA GROUP CO., LTD.**, Foshan \(CN\)](https://www.amazon.com/Sharp-Microwaves-ZSMC1655BS-Countertop-Microwave/dp/B01N31DJUU/ref=sr_1_1?ie=UTF8&qid=1525111590&sr=8-1&keywords=Sharp+ZSMC1655BS+1.6+Cu+Ft+Microwave%2C+Stainless+Steel.> Jan. 6, 2017. Sharp ZSMC1655BS 1.6 Cu Ft Microwave, Stainless Steel.*</p></div>
<div data-bbox=)

Primary Examiner — Thomas Johannes
Assistant Examiner — Lauren McVey

(**) **Term:** **15 Years**

(74) *Attorney, Agent, or Firm* — Morgan, Lewis & Bockius LLP

(21) Appl. No.: **29/628,502**

(57) **CLAIM**

(22) Filed: **Dec. 5, 2017**

The ornamental design for a microwave oven, as shown and described.

(30) **Foreign Application Priority Data**

Jul. 21, 2017 (CN) 2017 3 0325363

(51) **LOC (11) Cl.** **07-02**

(52) **U.S. Cl.**
USPC **D7/651**

(58) **Field of Classification Search**
USPC D7/323, 339, 340, 341, 347, 348, 349, D7/351, 350.1, 350.2, 350.3, 350.4, 402, D7/403, 405

CPC .. A21B 2/00; A21B 3/02; F24C 15/02; H05B 1/0263; H05B 2206/044; H05B 6/763; H05B 6/76; H05B 6/802; H05B 6/808; H05B 6/64

See application file for complete search history.

DESCRIPTION

FIG. 1 is a front perspective view of a microwave oven showing my new design;
FIG. 2 is a front elevational view of the microwave oven shown in FIG. 1;
FIG. 3 is a rear elevational view of the microwave oven shown in FIG. 1;
FIG. 4 is a right-side elevational view of the microwave oven shown in FIG. 1;
FIG. 5 is a left-side elevational view of the microwave oven shown in FIG. 1;
FIG. 6 is a top plan view of the microwave oven shown in FIG. 1; and,
FIG. 7 is a bottom plan view of the microwave oven shown in FIG. 1.

The broken lines immediately adjacent the shaded areas represent the bounds of the claimed design while all other

(56) **References Cited**

U.S. PATENT DOCUMENTS

D435,999 S * 1/2001 Noda D7/351
D561,529 S * 2/2008 Suh D7/351

(Continued)

(Continued)

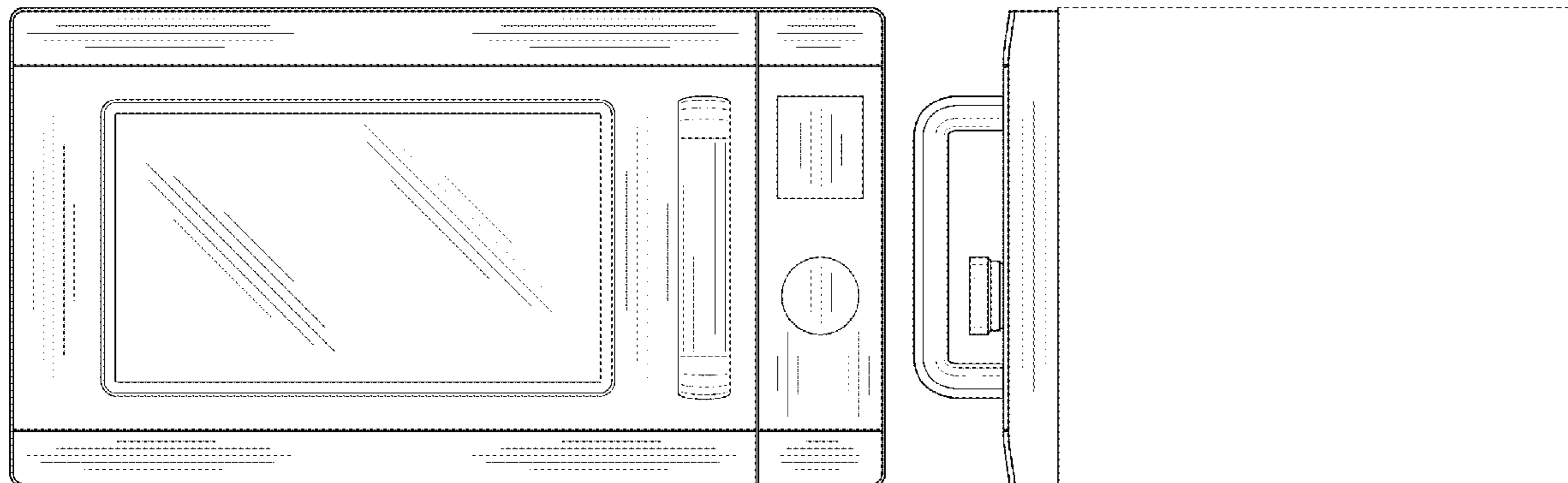

broken lines are directed to environment and are for illustrative purposes only; the broken lines form no part of the claimed design.

1 Claim, 5 Drawing Sheets

(56)

References Cited

U.S. PATENT DOCUMENTS

D576,834	S	*	9/2008	Shin	D7/351
D576,835	S	*	9/2008	Shin	D7/351
D607,264	S	*	1/2010	Lee	D7/351
D657,607	S	*	4/2012	Ohmae	D7/351
D665,219	S	*	8/2012	Ohmae	D7/351
D707,074	S	*	6/2014	Shin	D7/351
D741,639	S	*	10/2015	Kim	D7/351
D769,669	S	*	10/2016	Kim	D7/351
D773,235	S	*	12/2016	Chung	D7/351
D781,638	S	*	3/2017	Chung	D7/351
D813,592	S	*	3/2018	Jeon	D7/351

* cited by examiner

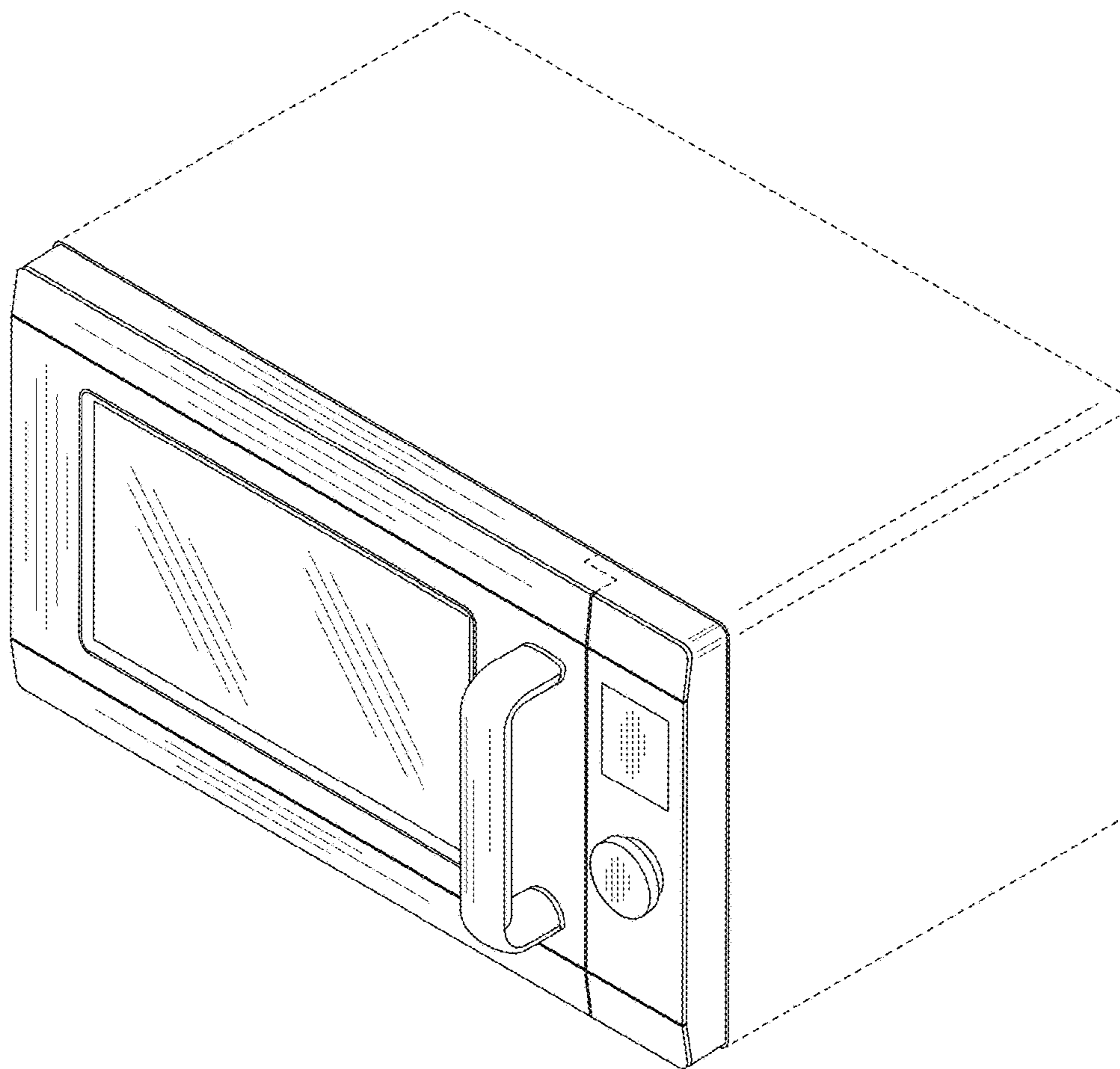

FIG. 1

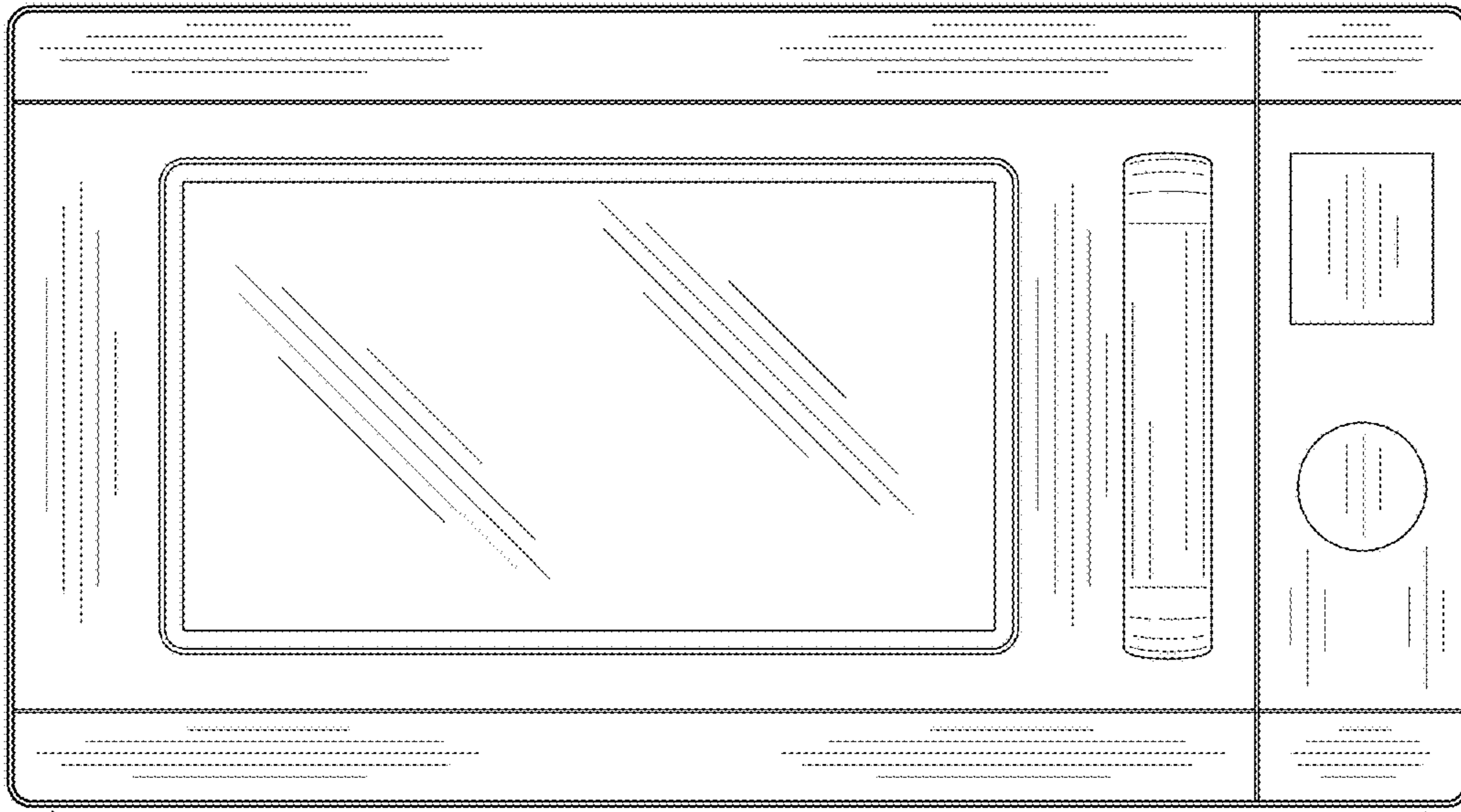

FIG. 2



FIG. 3

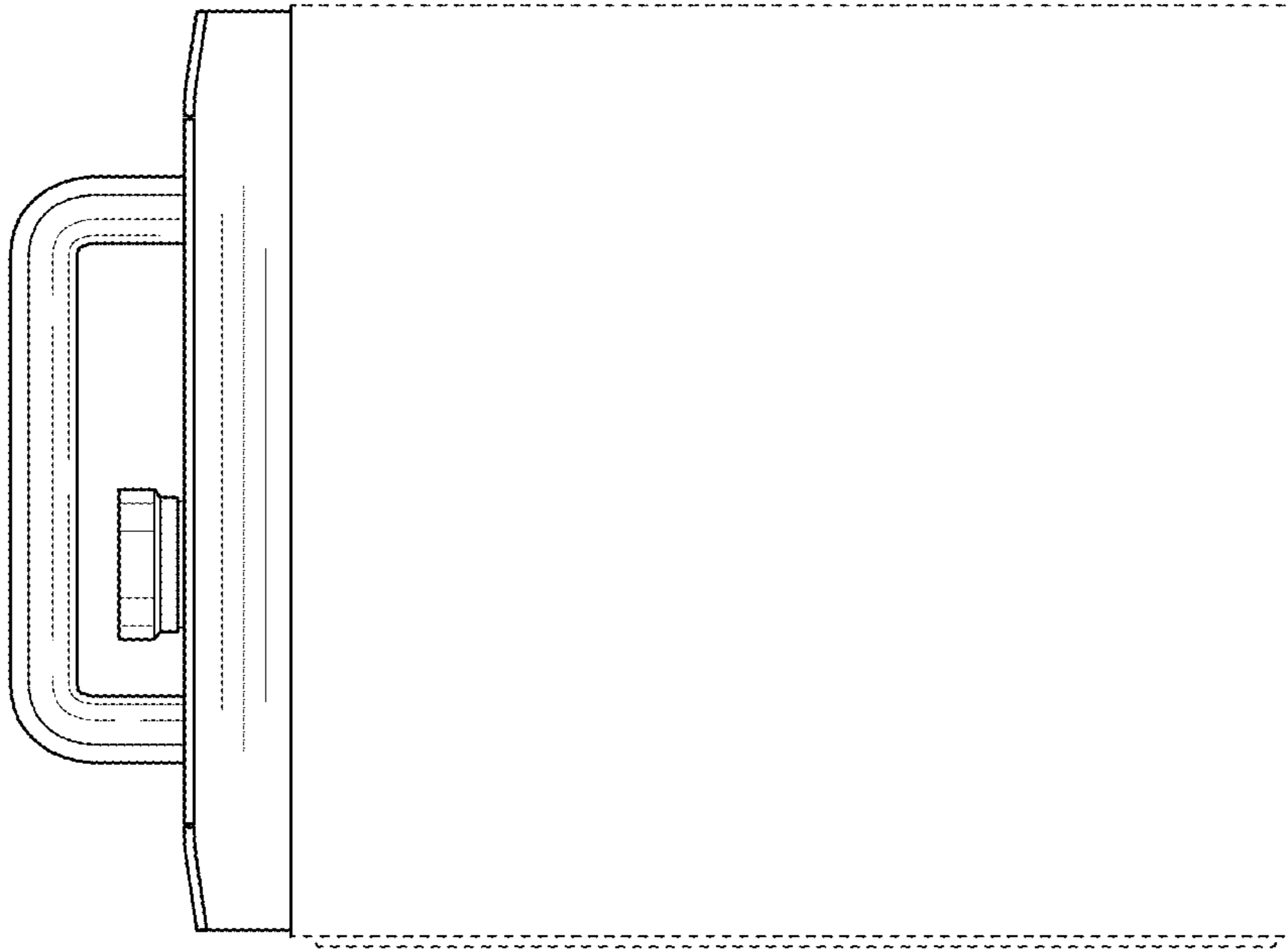

FIG. 4

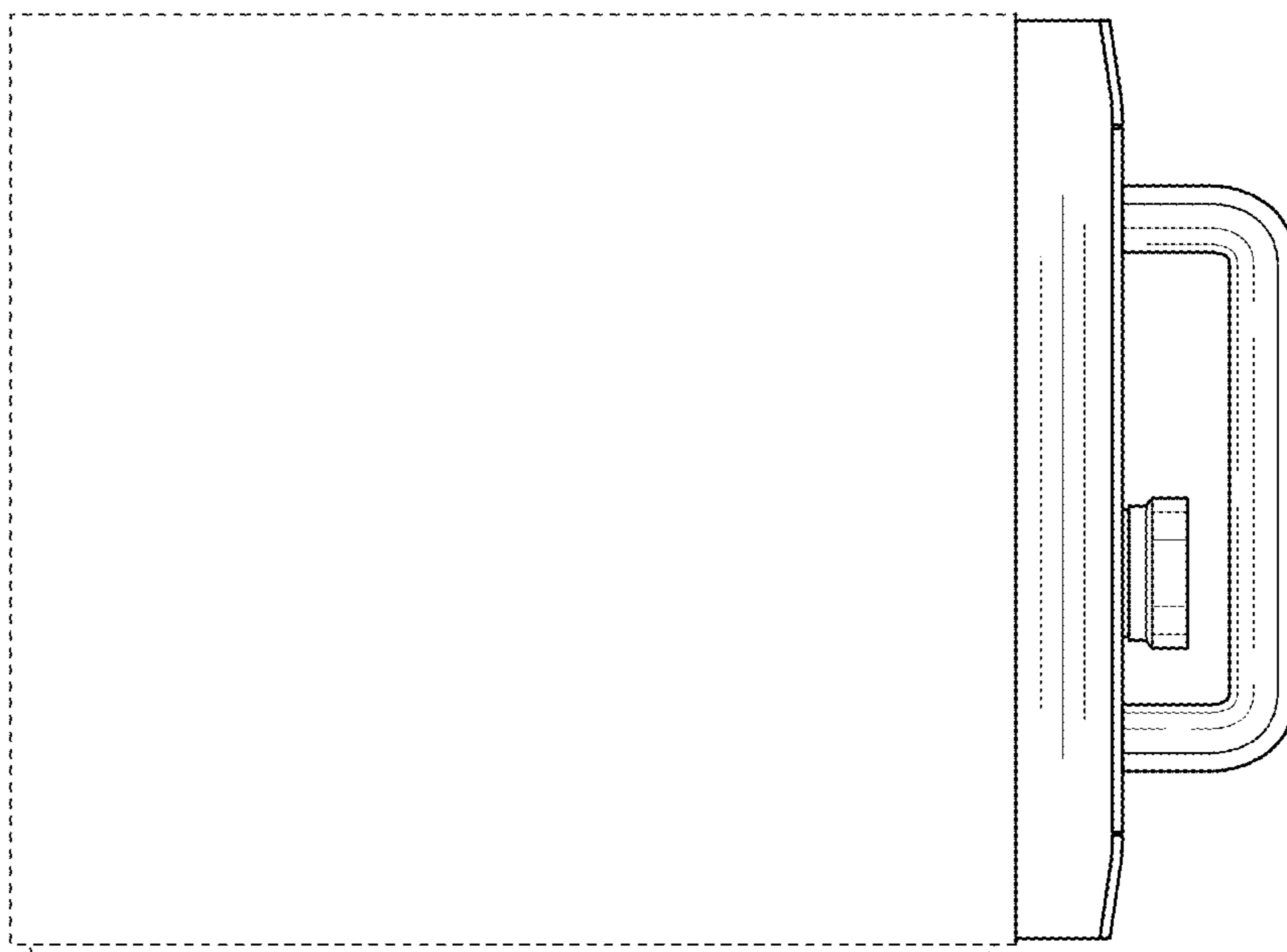

FIG. 5

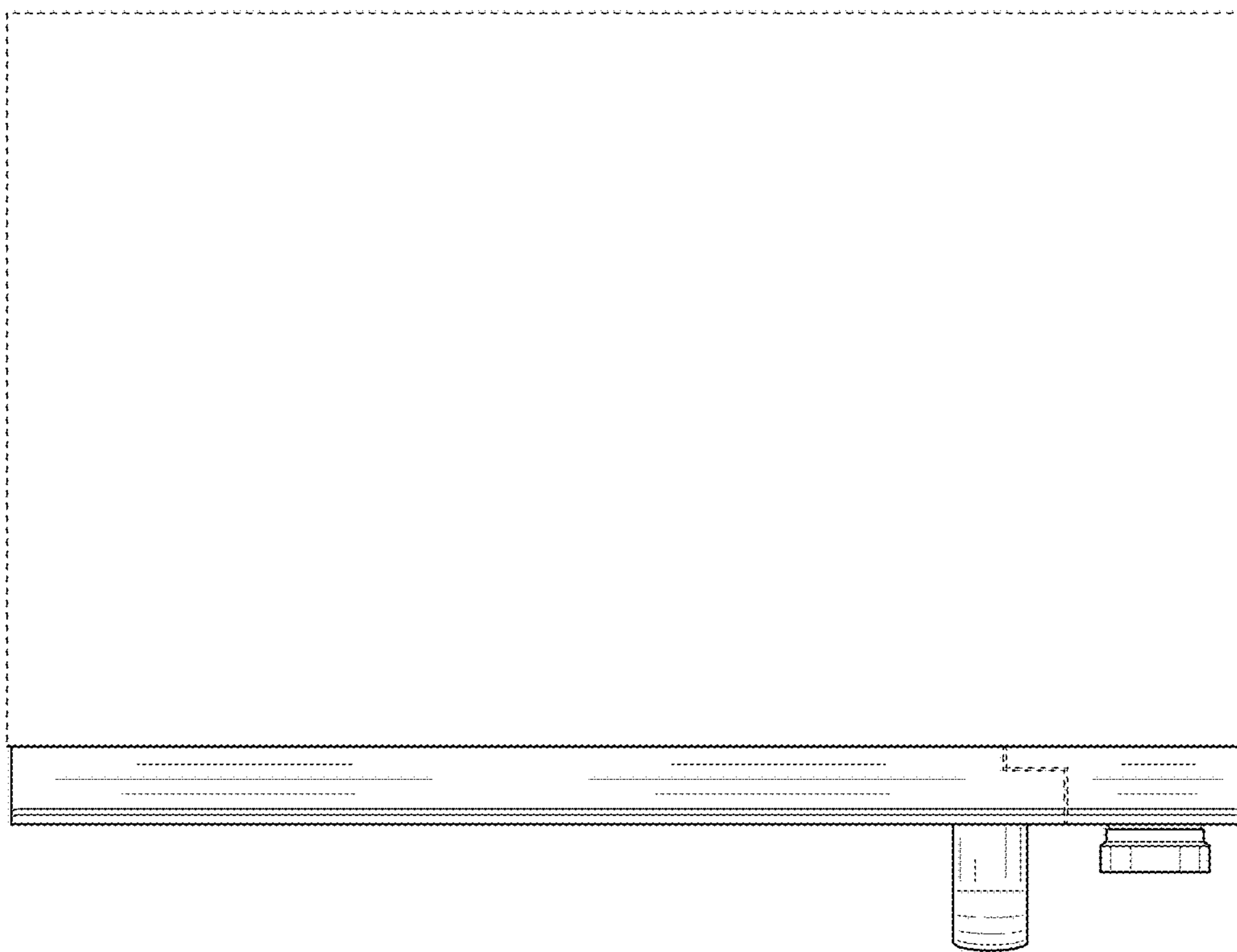

FIG. 6

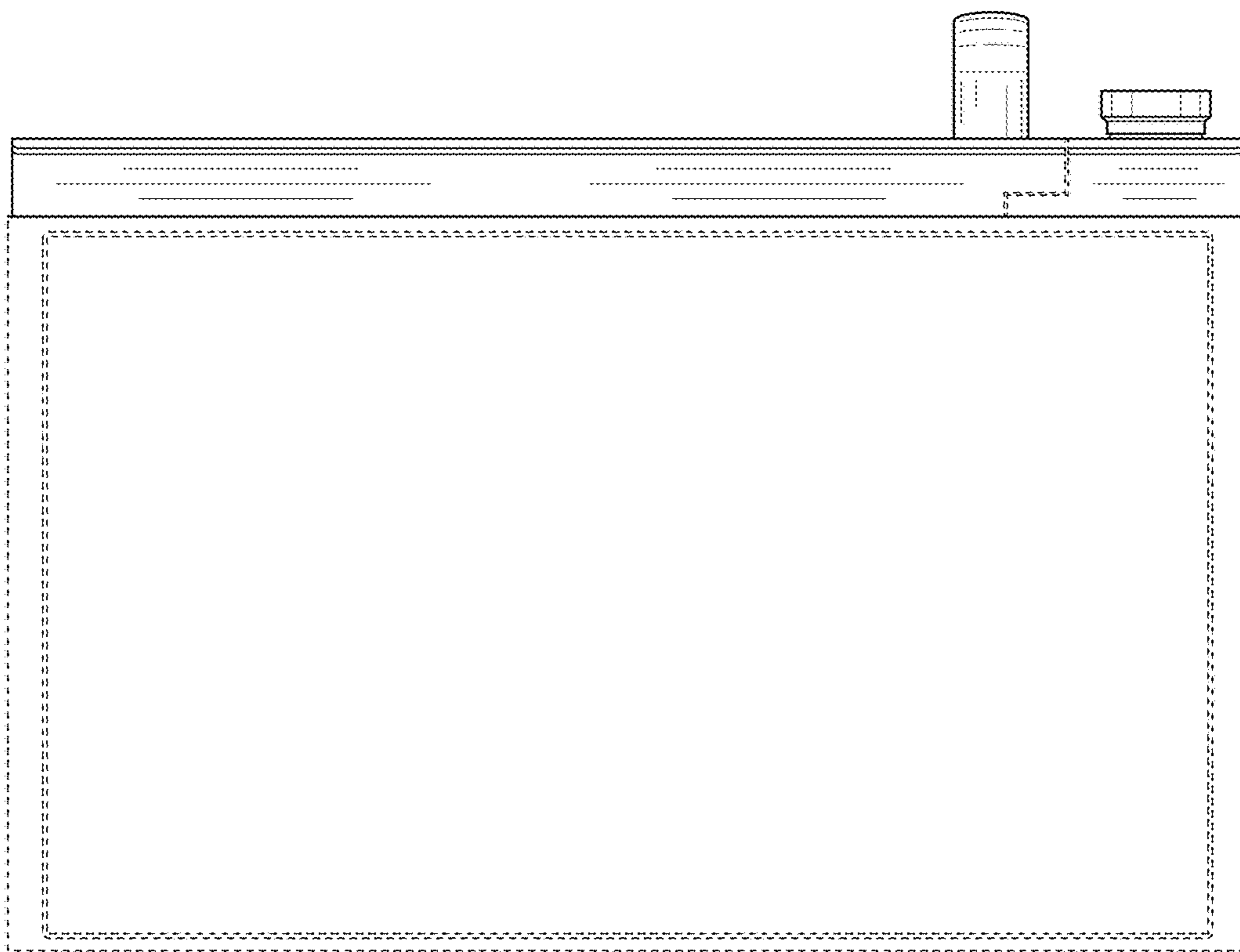

FIG. 7