



US00D829059S

(12) **United States Design Patent**
Tyra et al.

(10) **Patent No.:** **US D829,059 S**

(45) **Date of Patent:** **** Sep. 25, 2018**

(54) **DIMPLED BEVERAGE CONTAINER SLEEVE**

2013/0306630 A1* 11/2013 Babinsky B65D 81/3869
220/62.12

(71) Applicants: **Scott Tyra**, Jacksonville, TX (US);
Christopher Jones, Jacksonville, TX
(US)

* cited by examiner

(72) Inventors: **Scott Tyra**, Jacksonville, TX (US);
Christopher Jones, Jacksonville, TX
(US)

Primary Examiner — Freda S Nunn

(74) *Attorney, Agent, or Firm* — Allen, Dyer, Doppelt +
Gilchrist, PA

(**) Term: **15 Years**

(57) **CLAIM**

(21) Appl. No.: **29/610,674**

The ornamental design for a dimpled beverage container sleeve, as shown and described.

(22) Filed: **Jul. 14, 2017**

(51) **LOC (11) Cl.** **07-01**

(52) **U.S. Cl.**

USPC **D7/624.2**

(58) **Field of Classification Search**

USPC D7/601, 605, 607, 608, 615, 624.2, 625;
D6/531-534; D3/304-314; D9/444,
D9/501-504, 574, 575, 779; 220/592.17
CPC .. F25D 3/08; B65D 25/30; B65D 7/24; B65D
81/3876; B65D 81/3879; B65D 23/104;
B65D 81/38; B65D 81/3886; B65D
81/3883; B65D 81/3881; B65D 83/00;
B65D 1/42; A45C 11/20; A47G 23/0216;
A47G 19/2288; A47G 23/0241; A47G
2023/0291; A45F 2200/0583; A61F 7/10;
B31D 5/0086; A47J 41/02

See application file for complete search history.

DESCRIPTION

FIG. 1 is a top perspective view of the beverage container sleeve, according to the present design;
FIG. 2 is a bottom perspective view of the beverage container sleeve, according to the present design;
FIG. 3 is a left side view of the beverage container sleeve, according to the present design;
FIG. 4 is a right side view of the beverage container sleeve, according to the present design;
FIG. 5 is a top side view of the beverage container sleeve, according to the present design;
FIG. 6 is a bottom side view of the beverage container sleeve, according to the present design;
FIG. 7 is a front side view of the beverage container sleeve, according to the present design; and,
FIG. 8 is a back side view of the beverage container sleeve, according to the present design.
The dashed lines shown in FIGS. 2, 5, and 6 form no part of the claimed design.

(56) **References Cited**

U.S. PATENT DOCUMENTS

D722,828 S * 2/2015 Shamoan D7/510
2005/0011467 A1* 1/2005 Mulich A01K 13/001
119/651

1 Claim, 8 Drawing Sheets

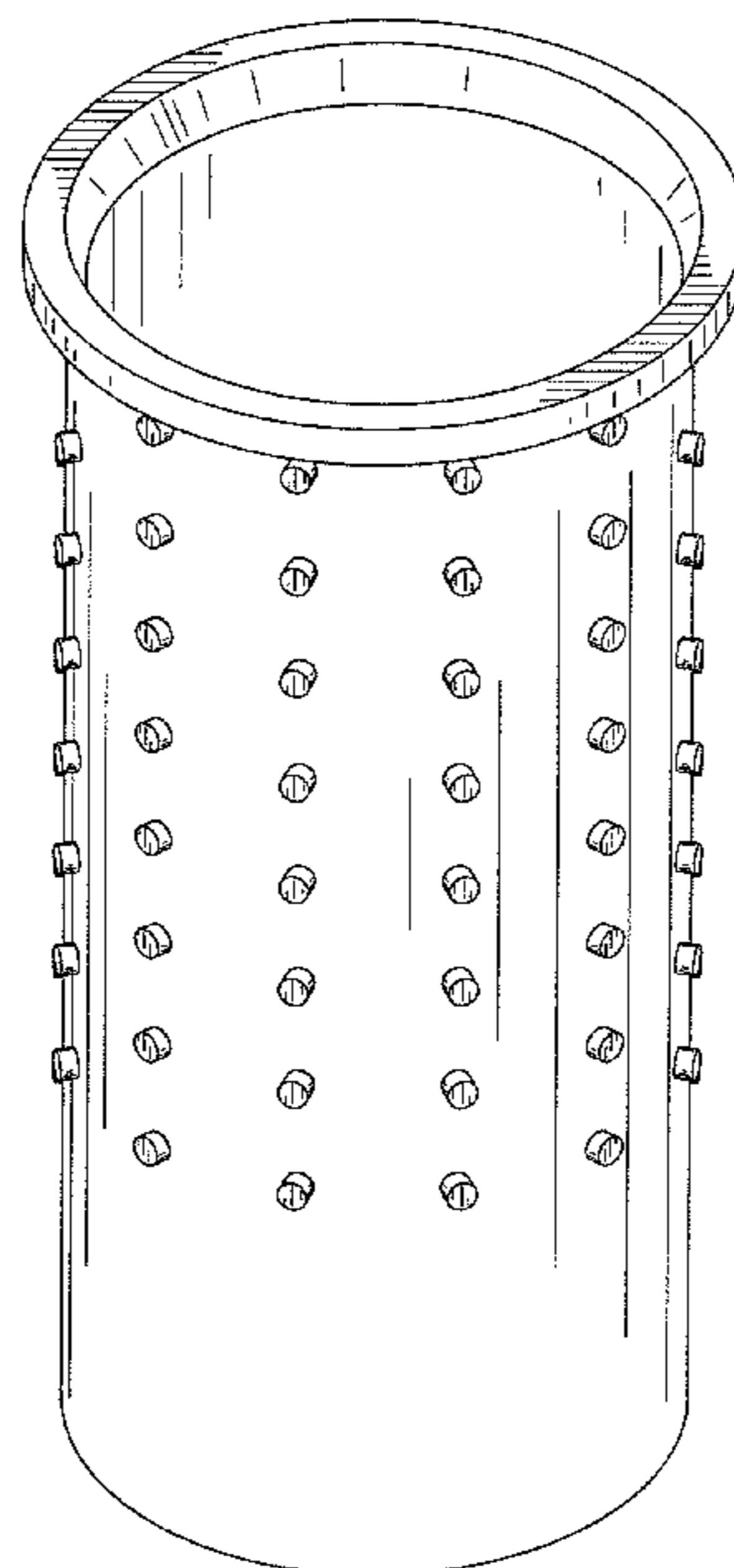

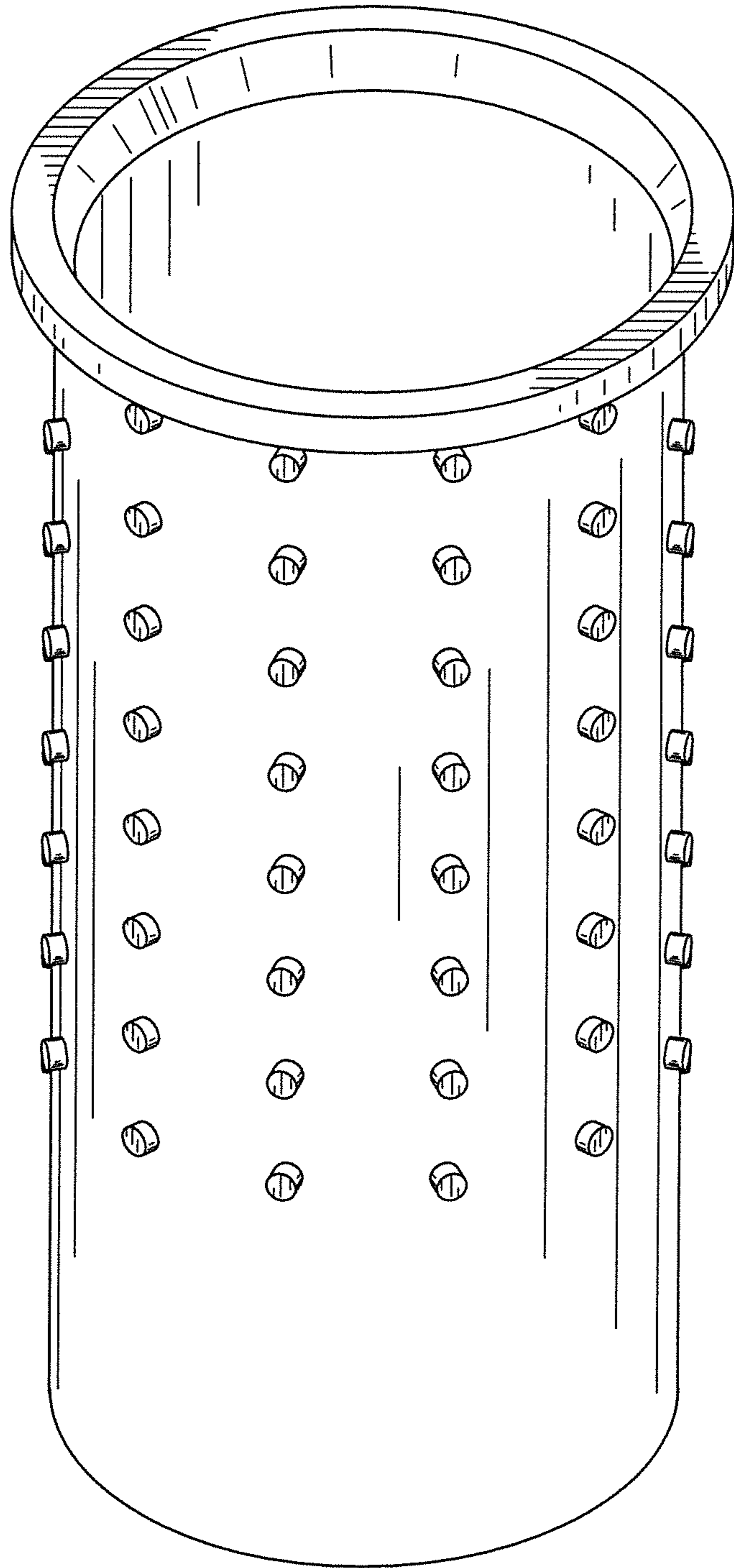

FIG. 1

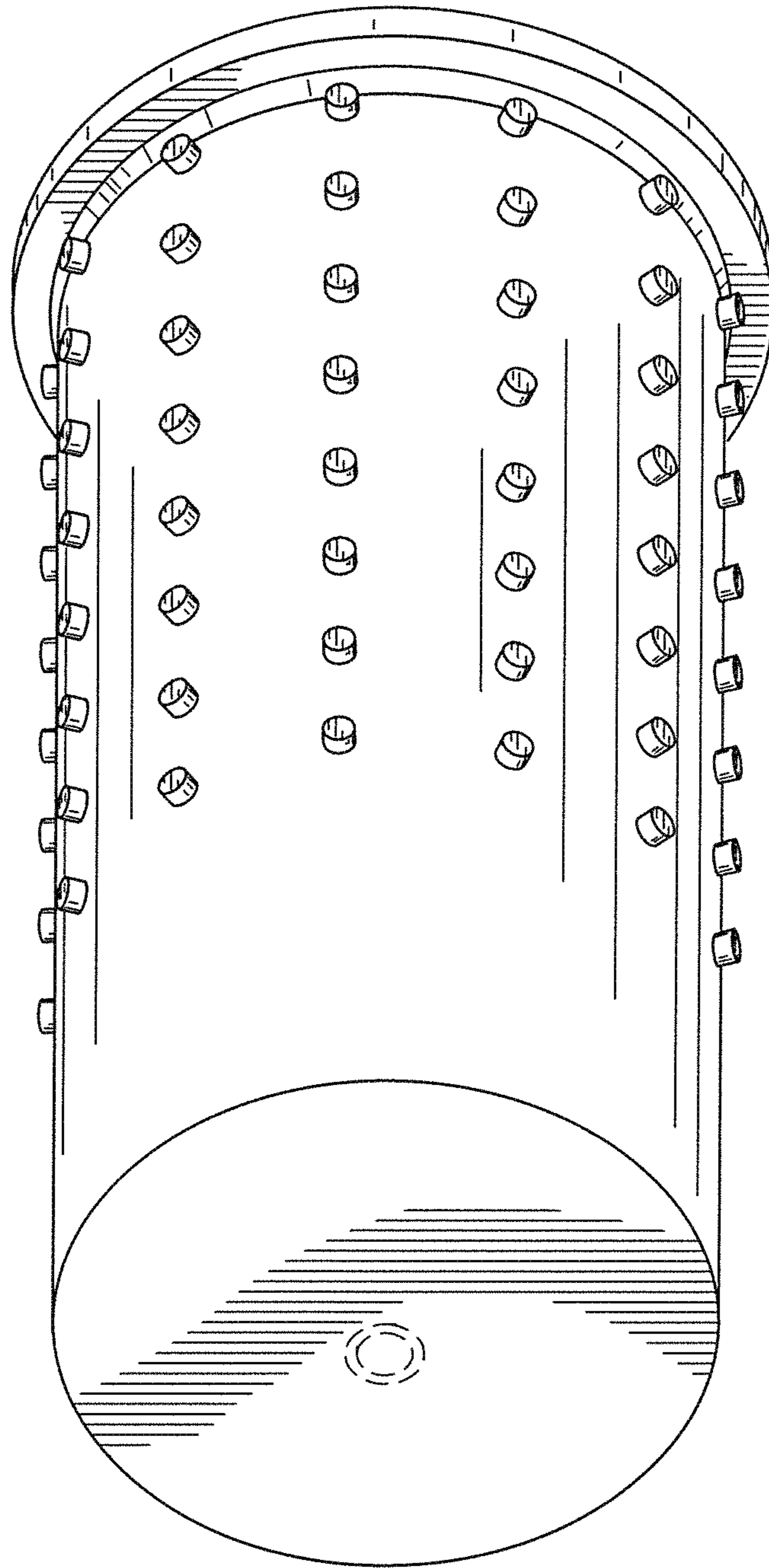

FIG. 2

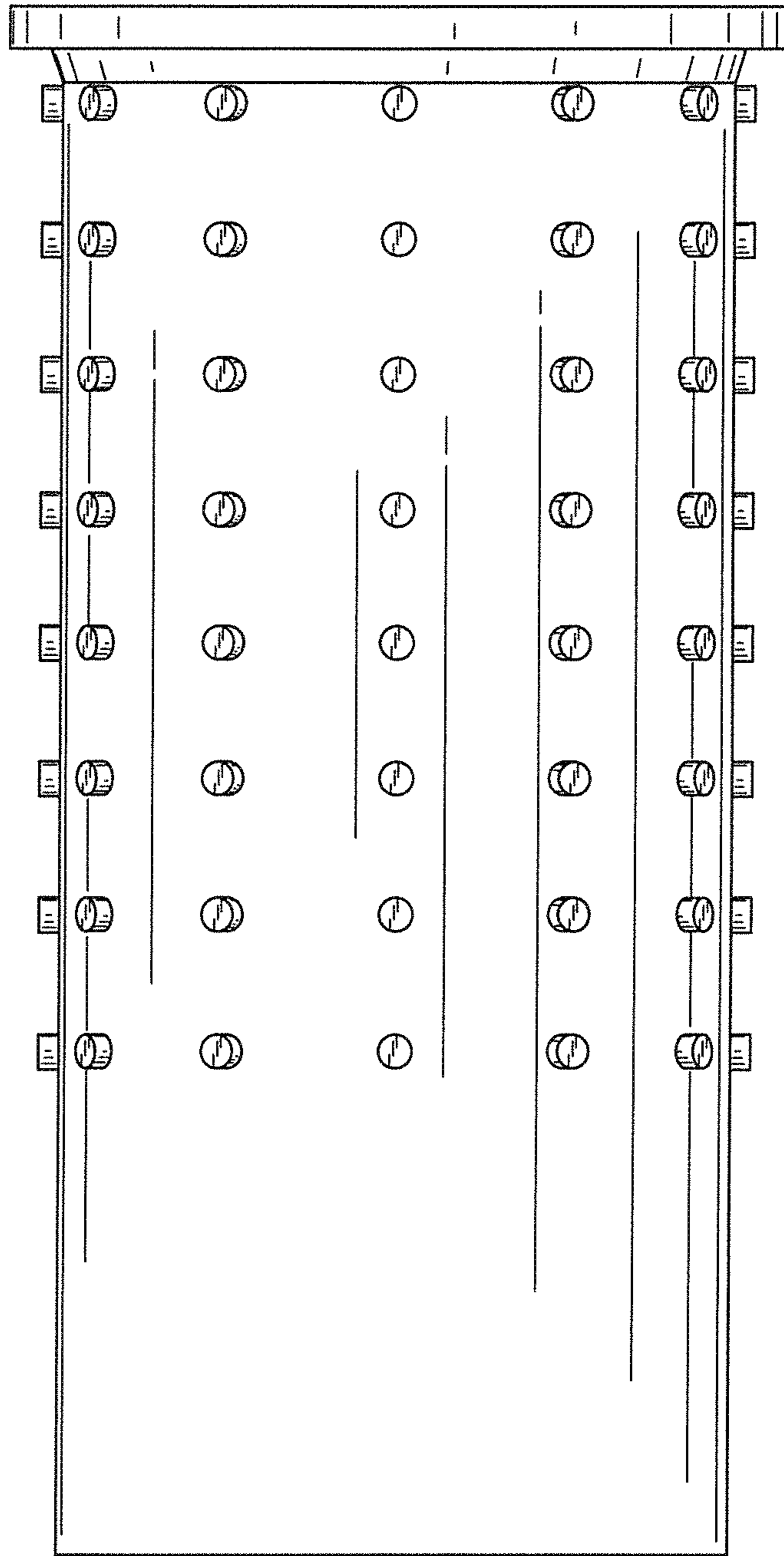

FIG. 3

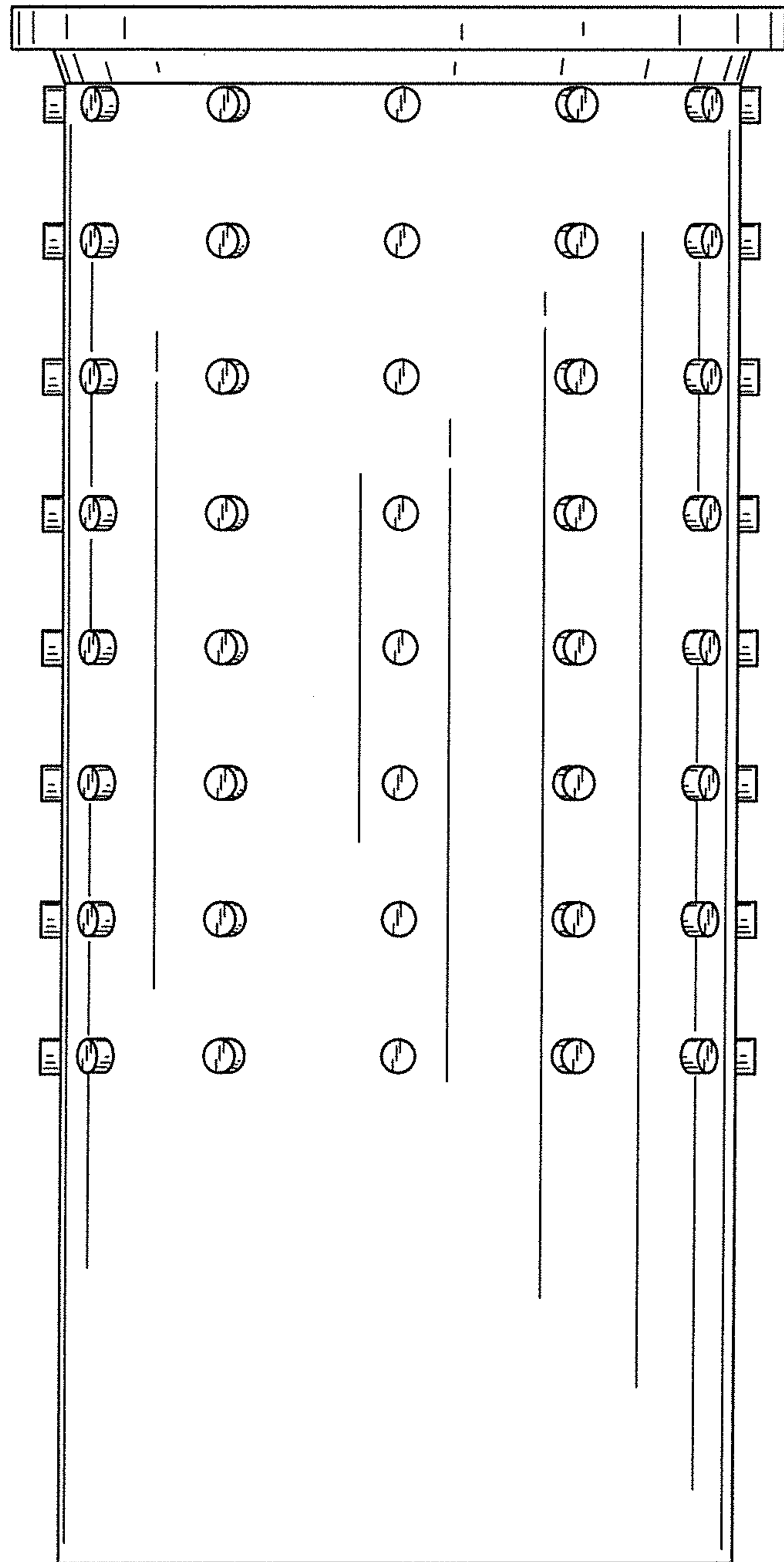

FIG. 4

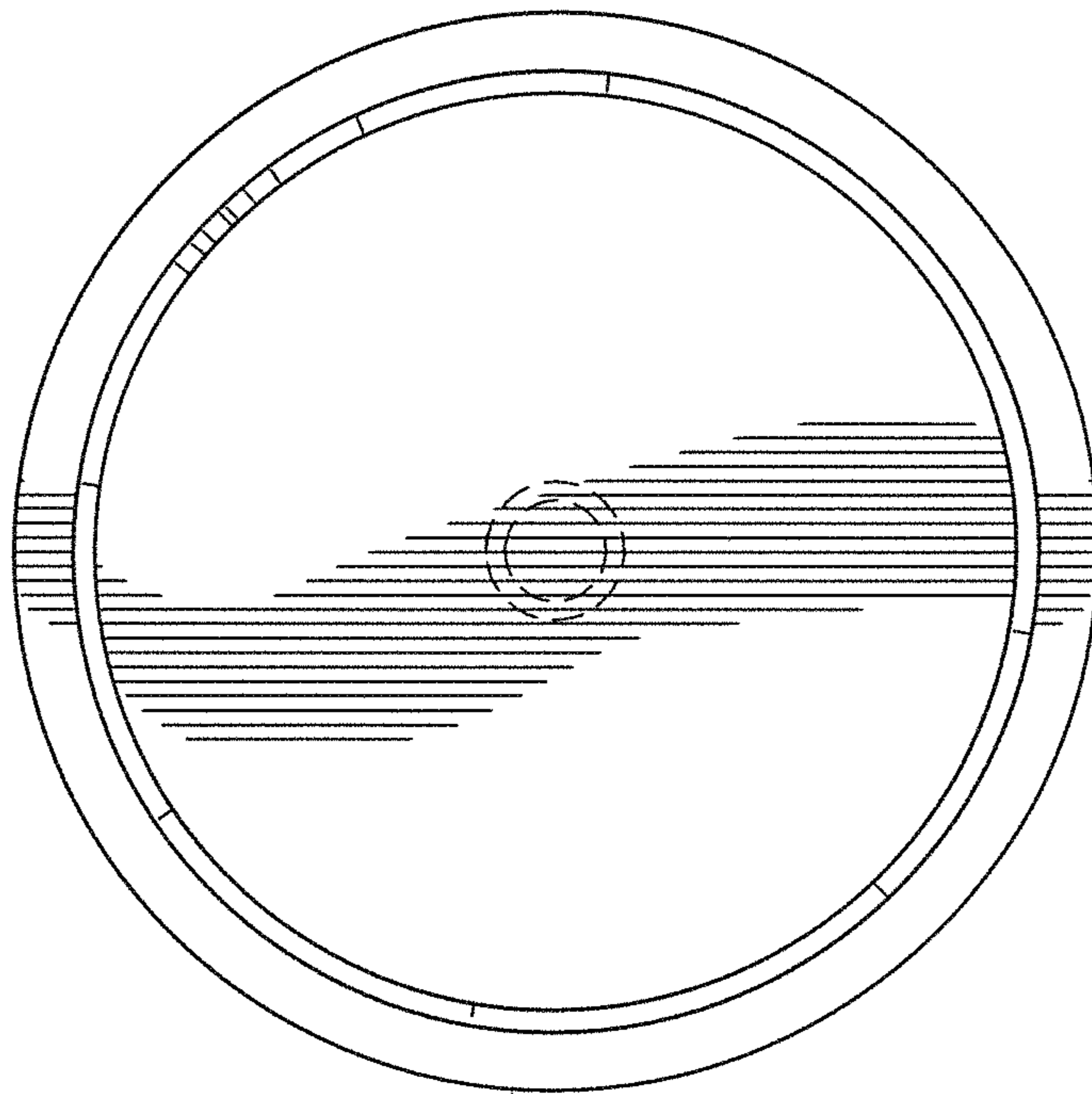

FIG. 5

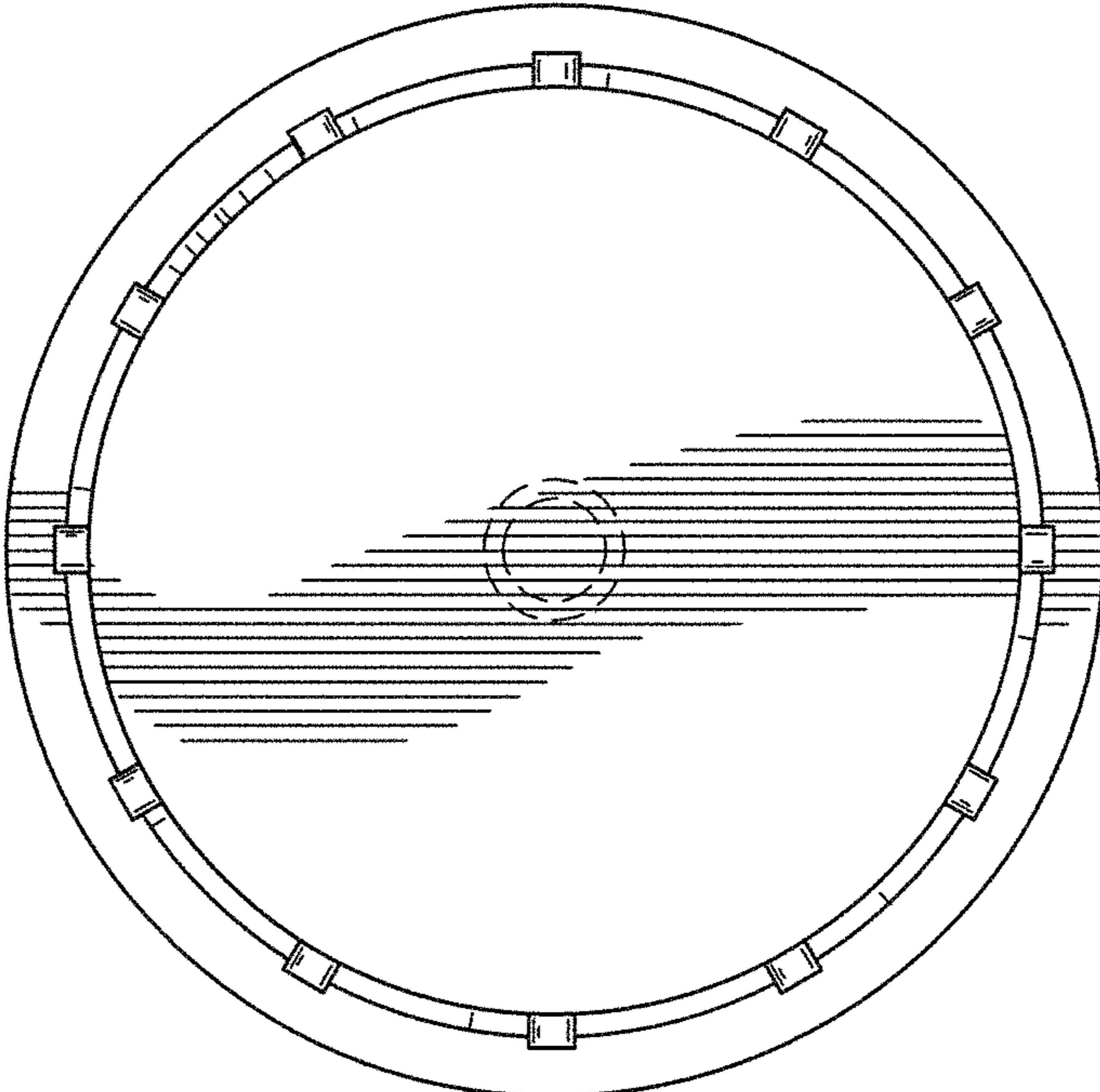

FIG. 6

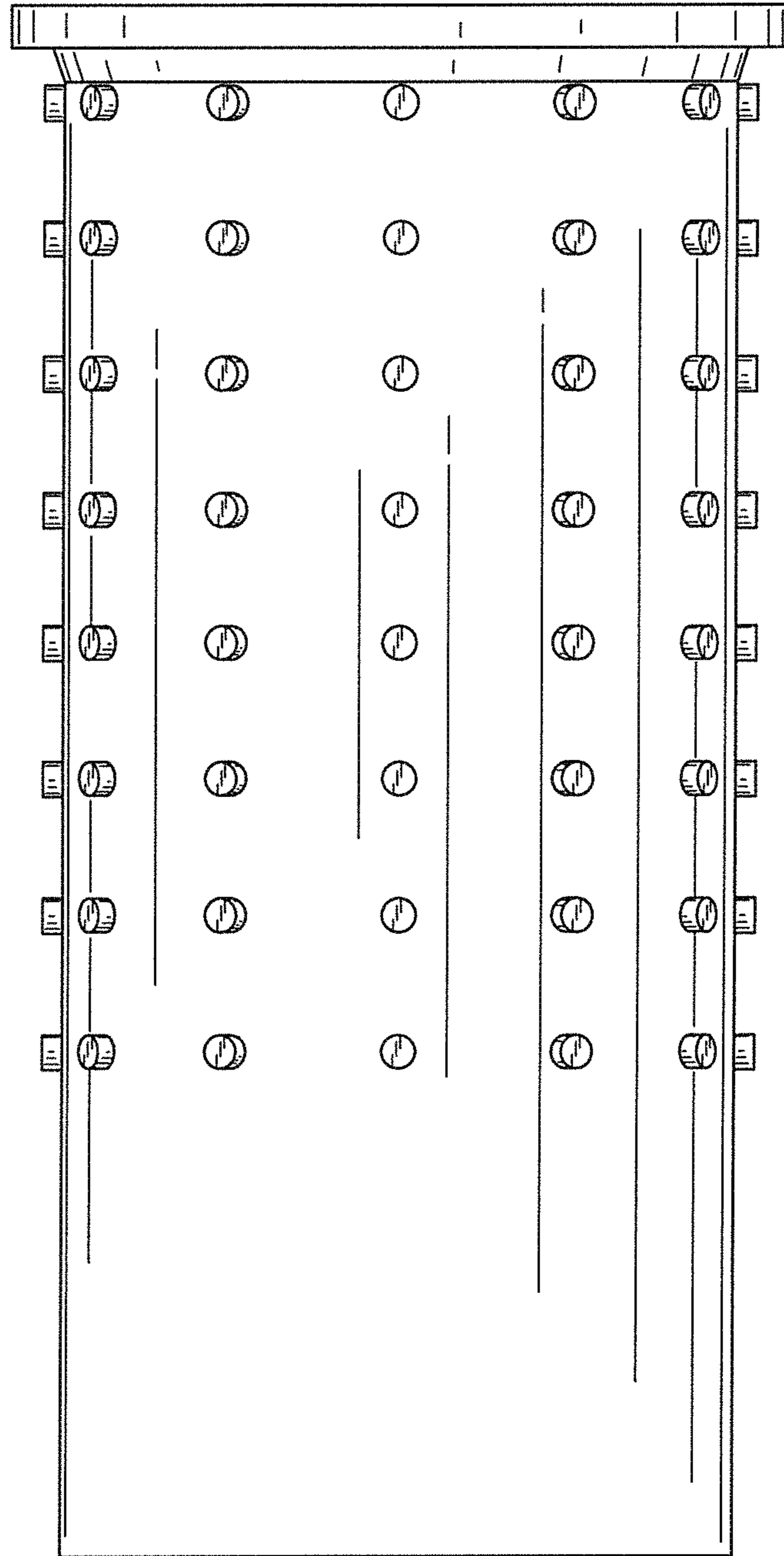

FIG. 7

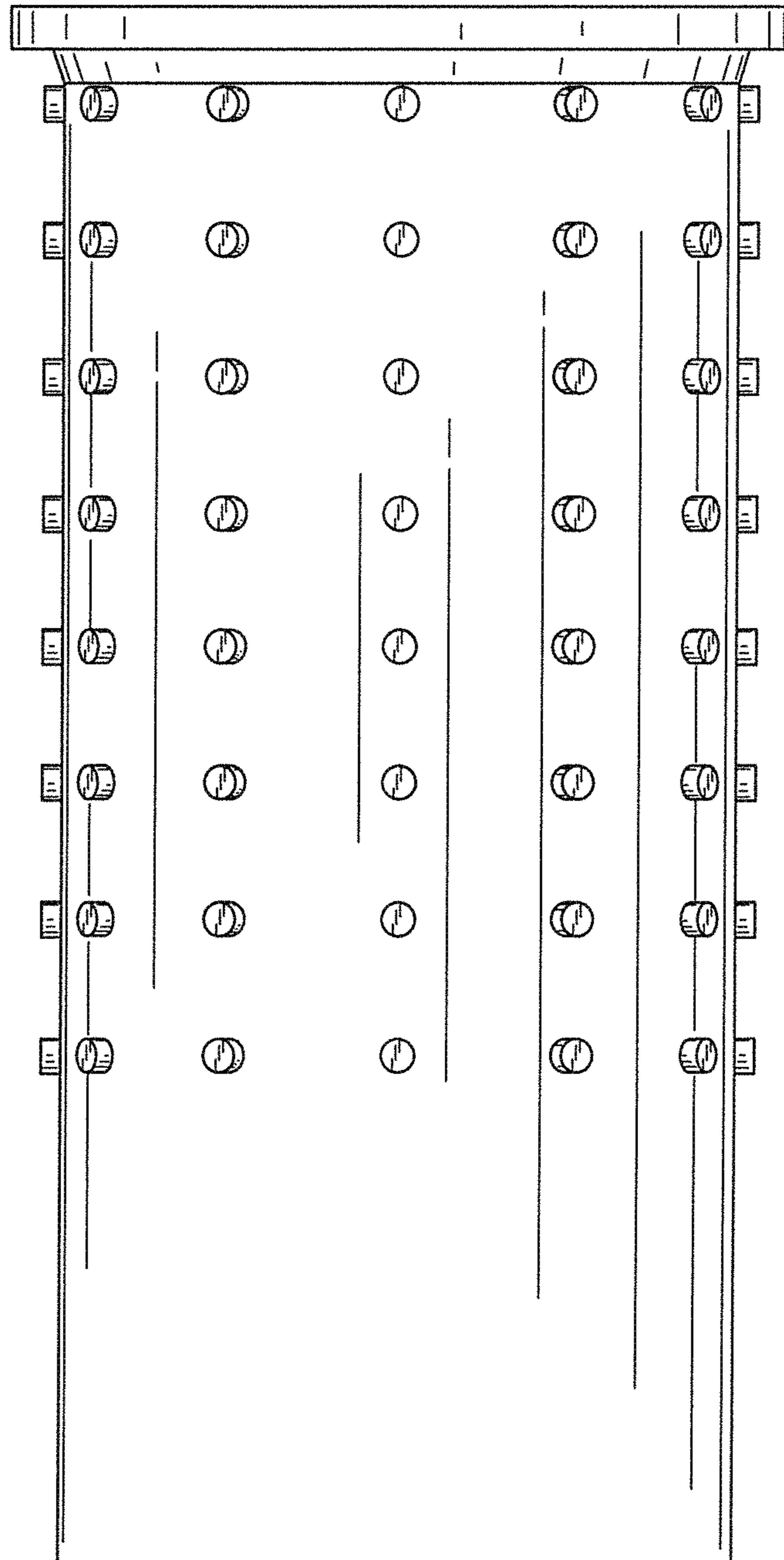

FIG. 8