



US00D829057S

(12) **United States Design Patent** (10) **Patent No.:** **US D829,057 S**  
**Agado** (45) **Date of Patent:** **\*\* Sep. 25, 2018**

(54) **MAGNETIC HOLDER FOR A BEVERAGE CONTAINER**

(71) Applicant: **David R. Agado**, Scottsdale, AZ (US)

(72) Inventor: **David R. Agado**, Scottsdale, AZ (US)

(\*\*) Term: **15 Years**

(21) Appl. No.: **29/579,532**

(22) Filed: **Sep. 30, 2016**

(51) **LOC (11) Cl.** ..... **07-06**

(52) **U.S. Cl.**  
USPC ..... **D7/624.2**

(58) **Field of Classification Search**  
USPC ..... D7/603-608, 619.1-625; D9/444  
CPC .... A45F 5/02; A47J 41/0005; B65D 81/3876;  
B65D 81/3874; B65D 81/3886; B65D  
81/3823; A45C 11/20; A47G 23/0216;  
A47G 23/0258; F25D 3/08; F25D 3/14  
See application file for complete search history.

(56) **References Cited**

**U.S. PATENT DOCUMENTS**

D282,234 S *	1/1986	Henderson	.....	D7/608
D432,365 S *	10/2000	Corbella	.....	D7/608
7,228,987 B2	6/2007	Jones		
D701,079 S	3/2014	Arora		
D741,663 S	10/2015	Hansen		
2007/0138188 A1 *	6/2007	Mace	.....	B31D 5/0086 220/739
2008/0017654 A1 *	1/2008	Chu	.....	B65D 81/3886 220/739
2008/0060479 A1	3/2008	Nelson		
2008/0164269 A1 *	7/2008	Vorderkuntz	.....	B65D 81/3874 220/739
2011/0192859 A1 *	8/2011	Belford	.....	B65D 81/3876 220/739

2013/0075412 A1 *	3/2013	Schminke	.....	B65D 81/3876 220/739
2014/0061208 A1 *	3/2014	Boyd	.....	A47J 41/0005 220/592.17
2016/0213137 A1 *	7/2016	Sellars	.....	A45F 5/02

**OTHER PUBLICATIONS**

Magnetic Neoprene Collapsible Can Coolie for sale on Amazon.com.

\* cited by examiner

*Primary Examiner* — Terry A Wallace

(74) *Attorney, Agent, or Firm* — Mark V. Loen

(57) **CLAIM**

The ornamental design for a magnetic holder for a beverage container, as shown and described.

**DESCRIPTION**

FIG. 1 is a front view of a magnetic holder for a beverage container;  
 FIG. 2 is a right side view thereof, the left side view being a mirror image;  
 FIG. 3 is a top view thereof with a cross shaped opening centrally located on the bottom surface;  
 FIG. 4 is a bottom view thereof;  
 FIG. 5 is a back side view thereof;  
 FIG. 6 is an isometric view thereof;  
 FIG. 7 is an isometric view thereof with a beverage container drawn in broken lines showing the magnetic holder for a beverage container in condition of use; and,  
 FIG. 8 is a right side view thereof with a beverage container and a magnetically attaching structure drawn in broken lines showing the magnetic holder for a beverage container in a condition of use.  
 The broken lines of the can and wall in FIGS. 7 and 8 are for illustrating environmental structure and form no part of the claimed design. The remaining broken lines in FIGS. 1-8 are for unclaimed portion of the claimed design.

**1 Claim, 3 Drawing Sheets**

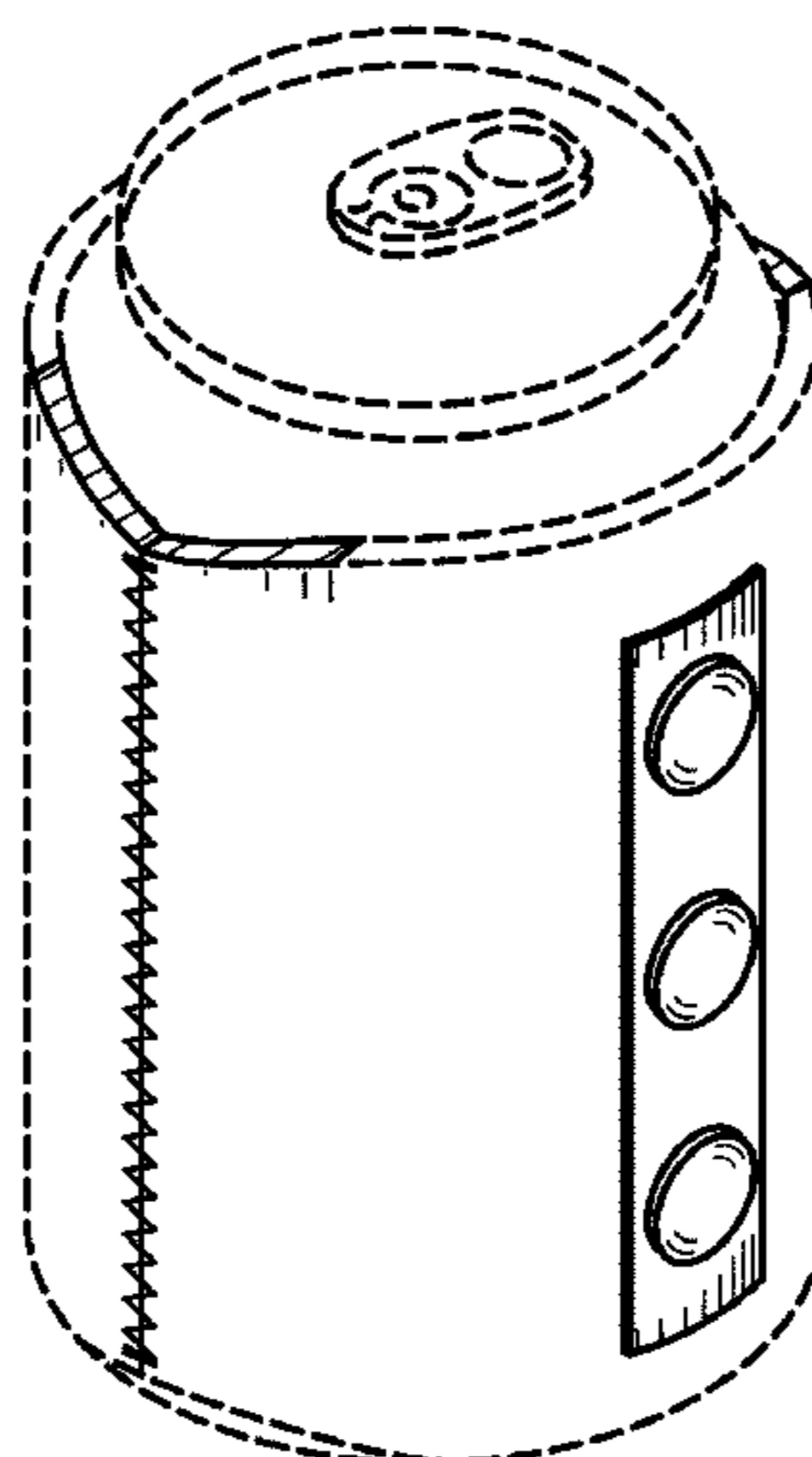

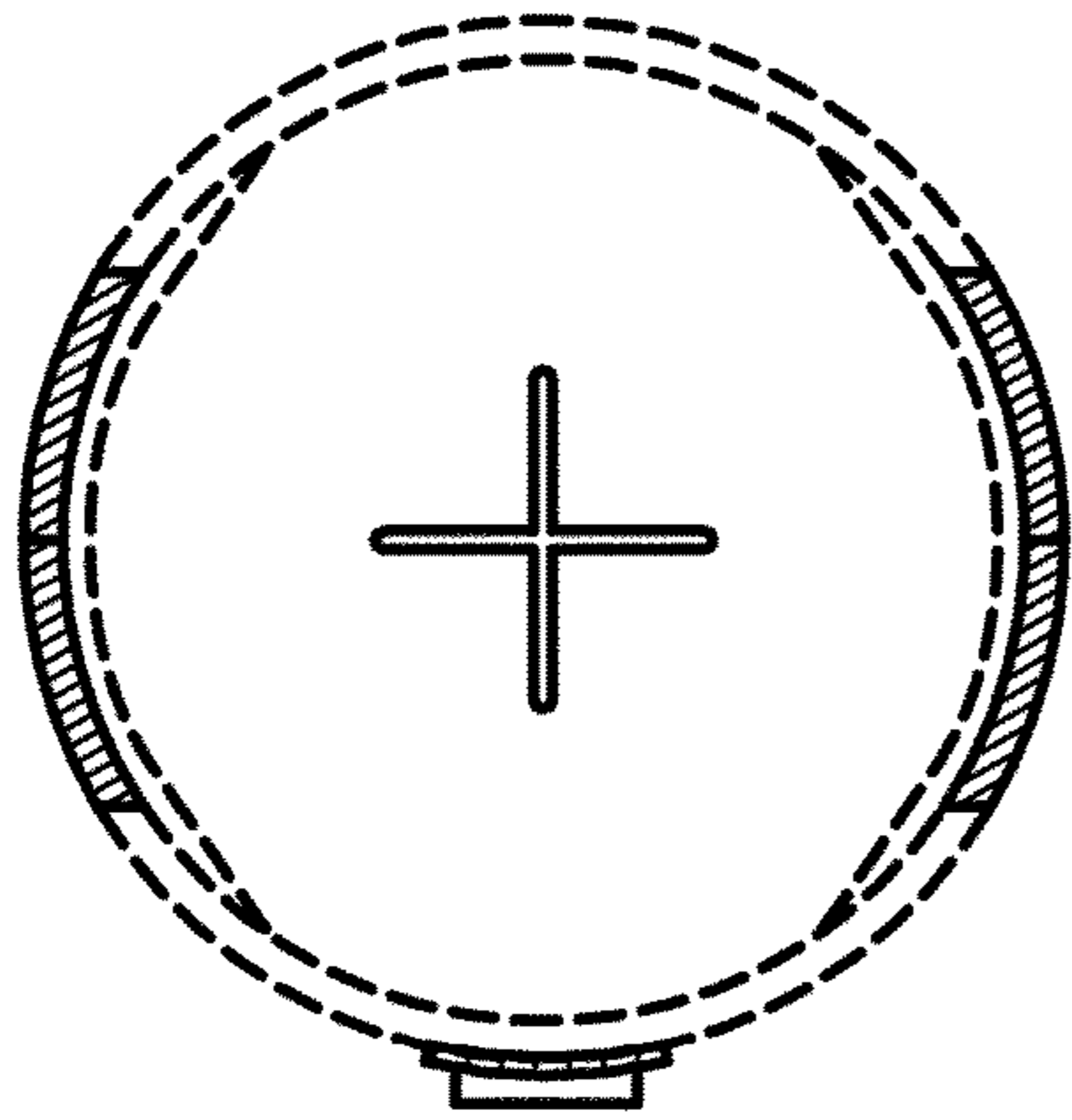

FIG. 3

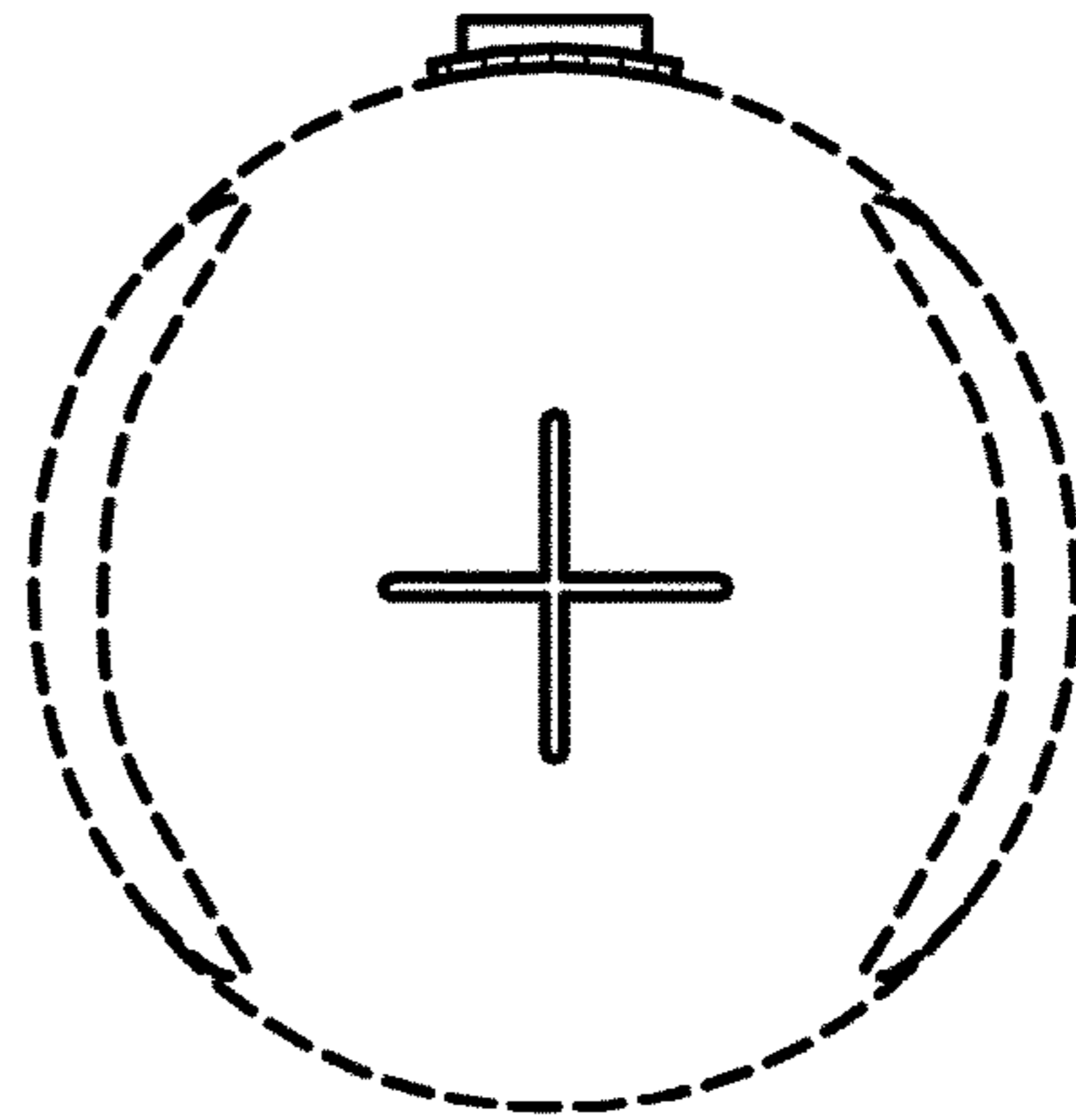

FIG. 4

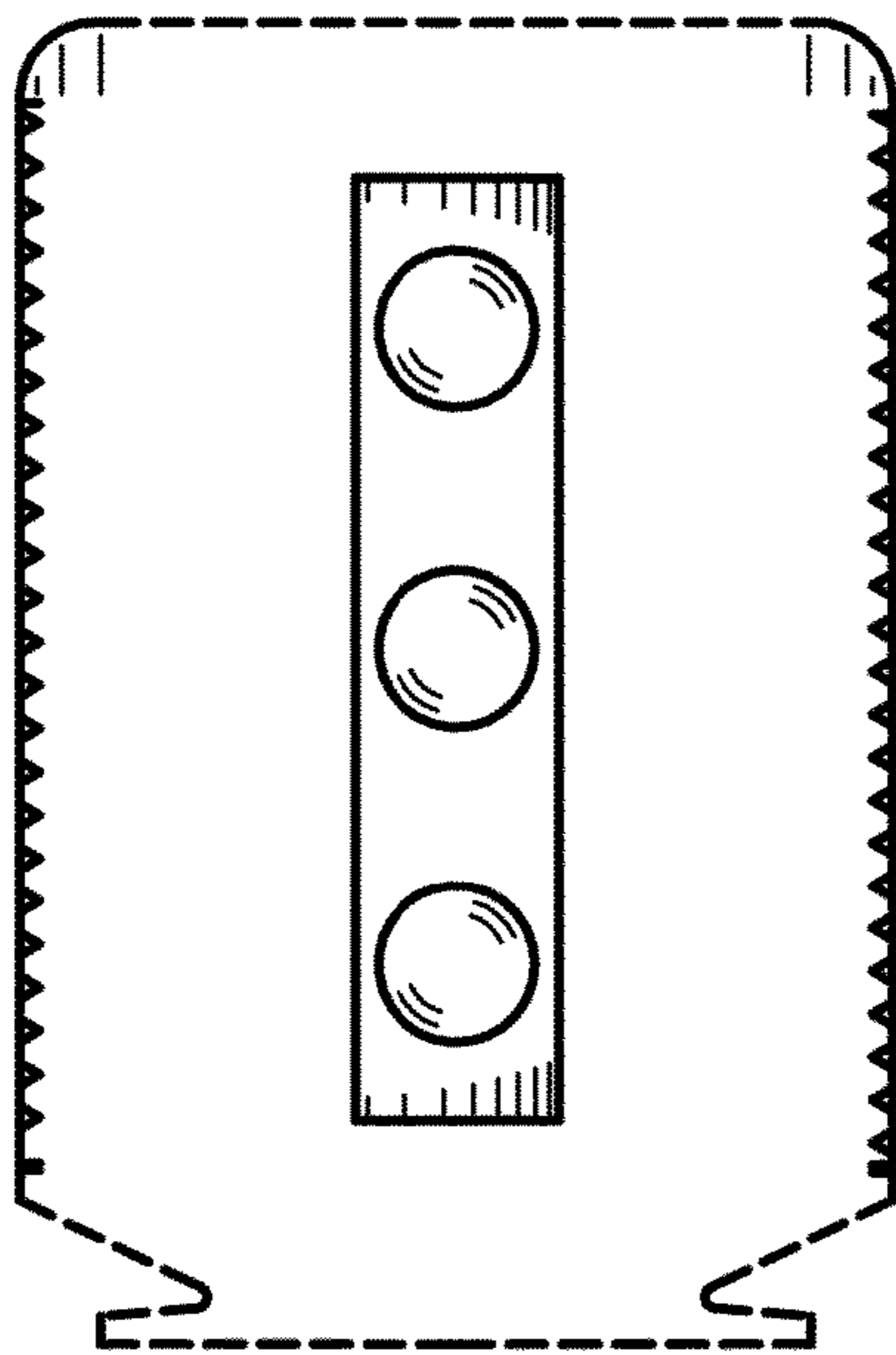

FIG. 1

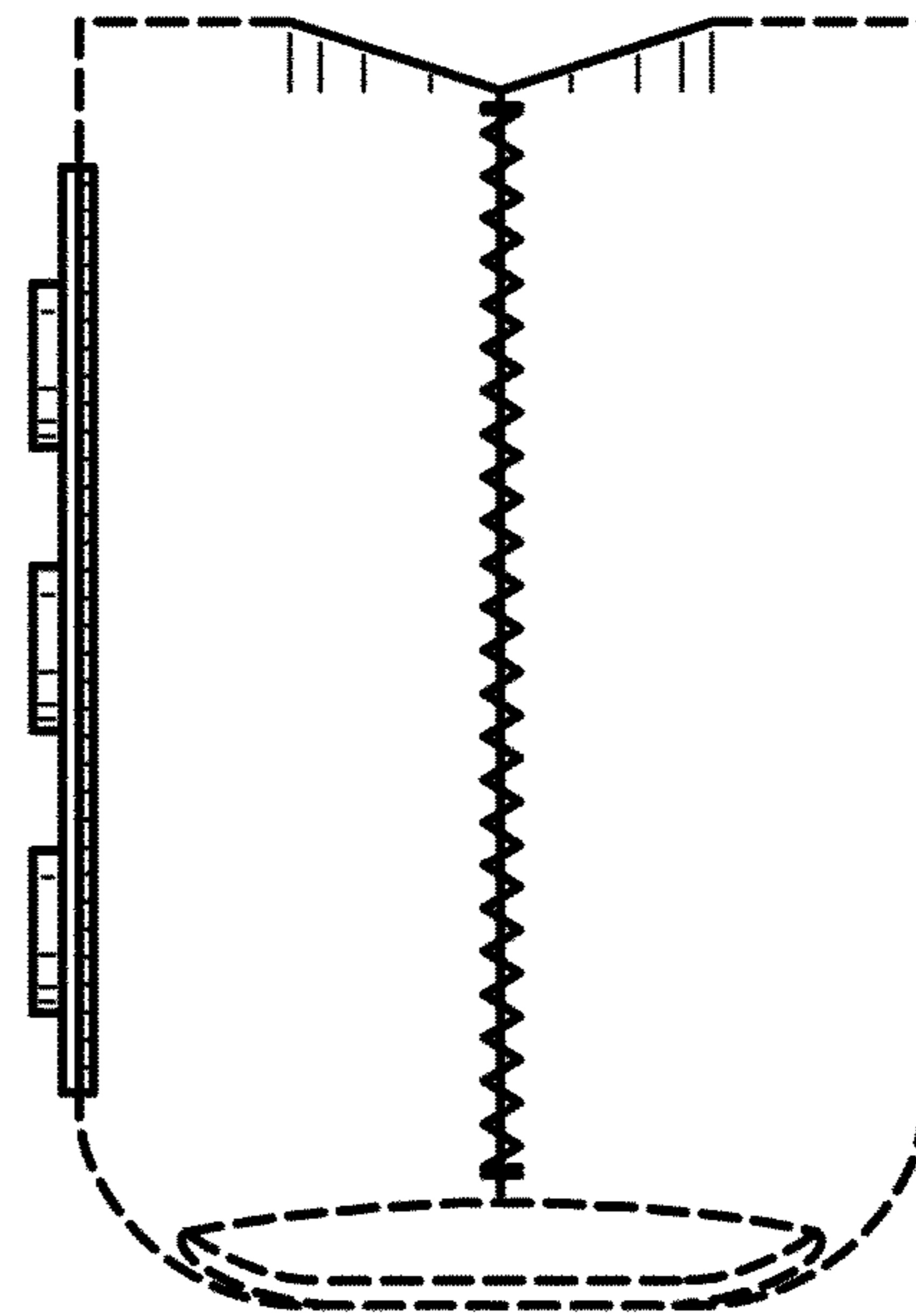

FIG. 2

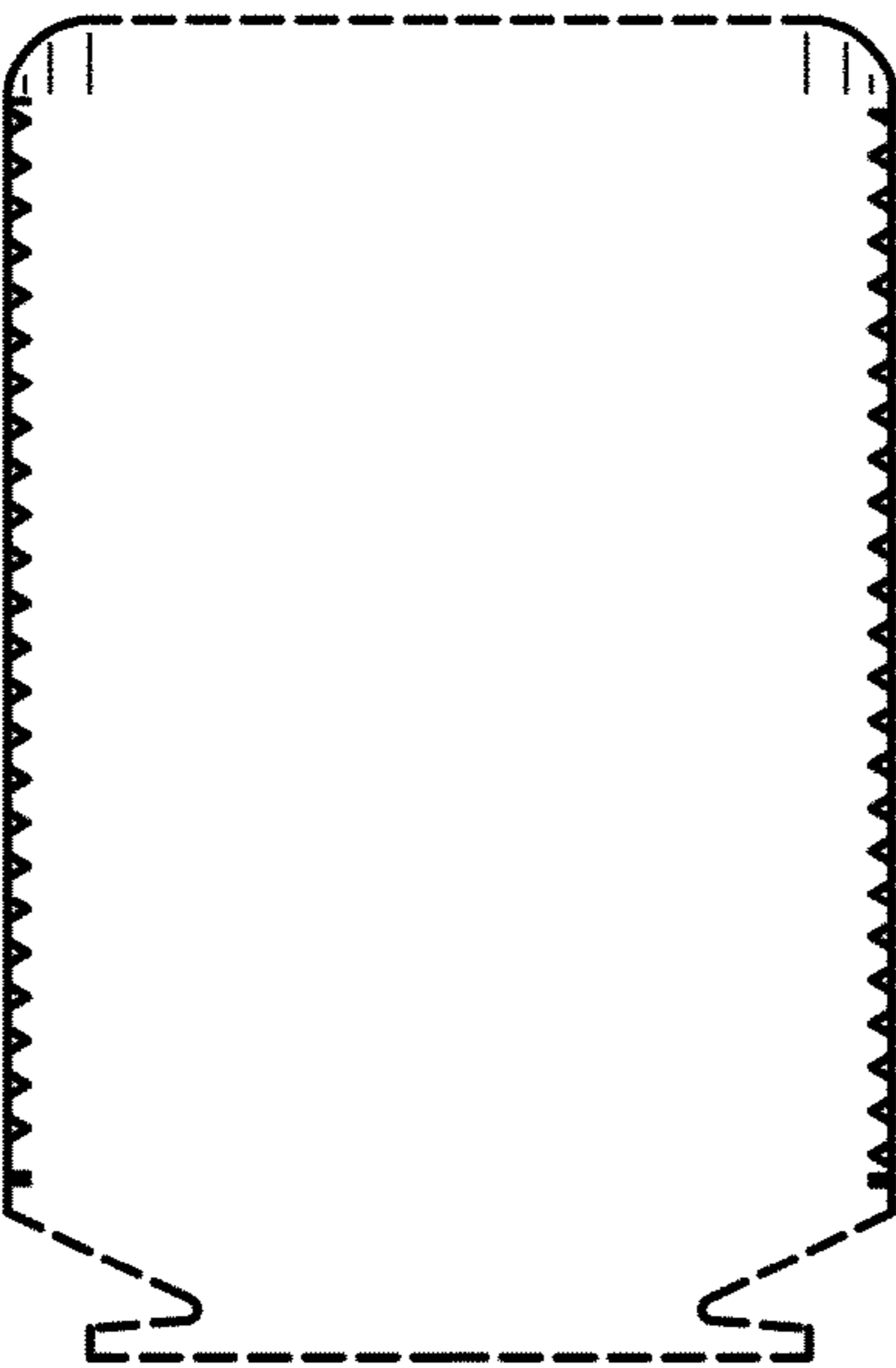

FIG. 5

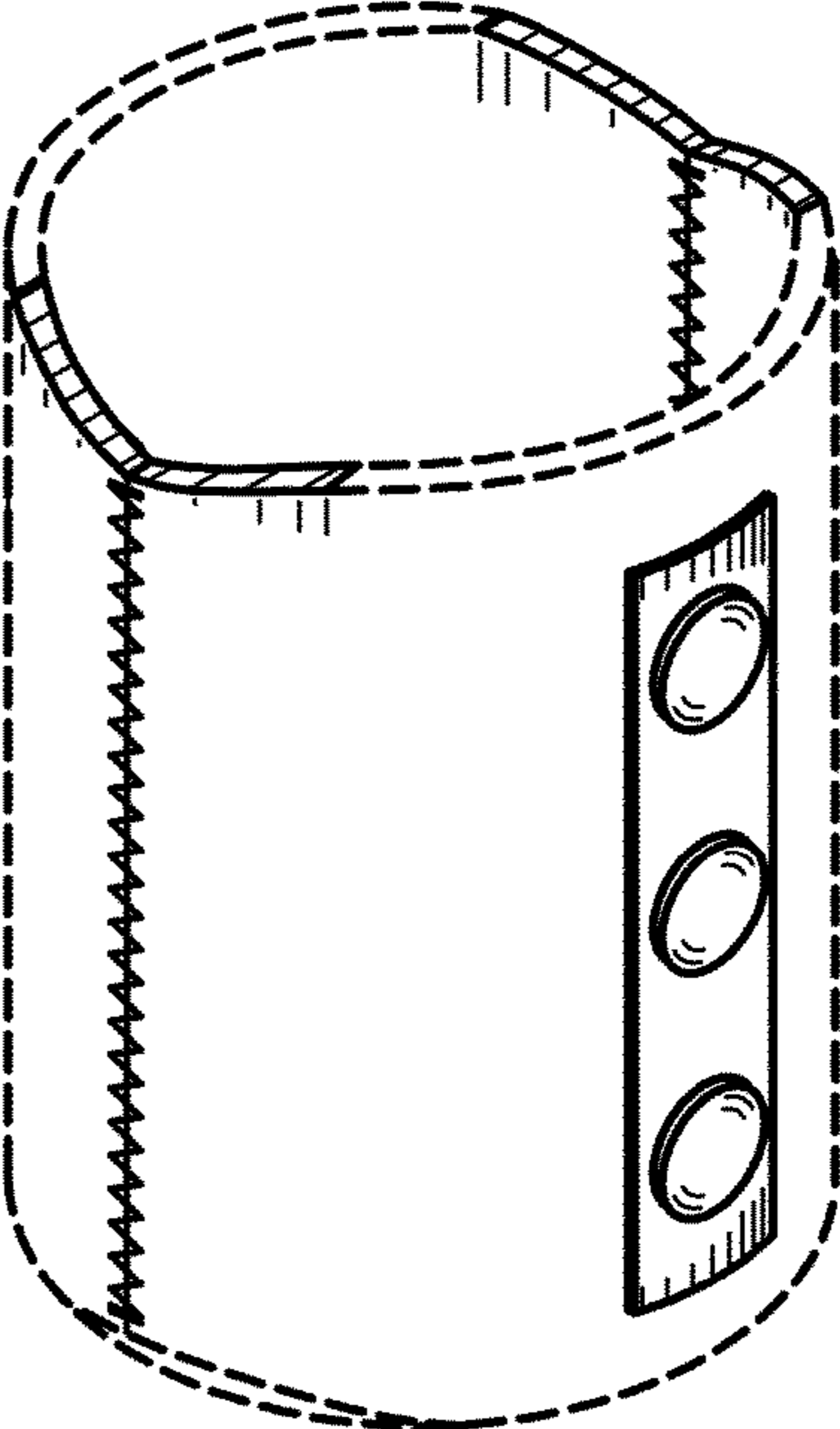

FIG. 6

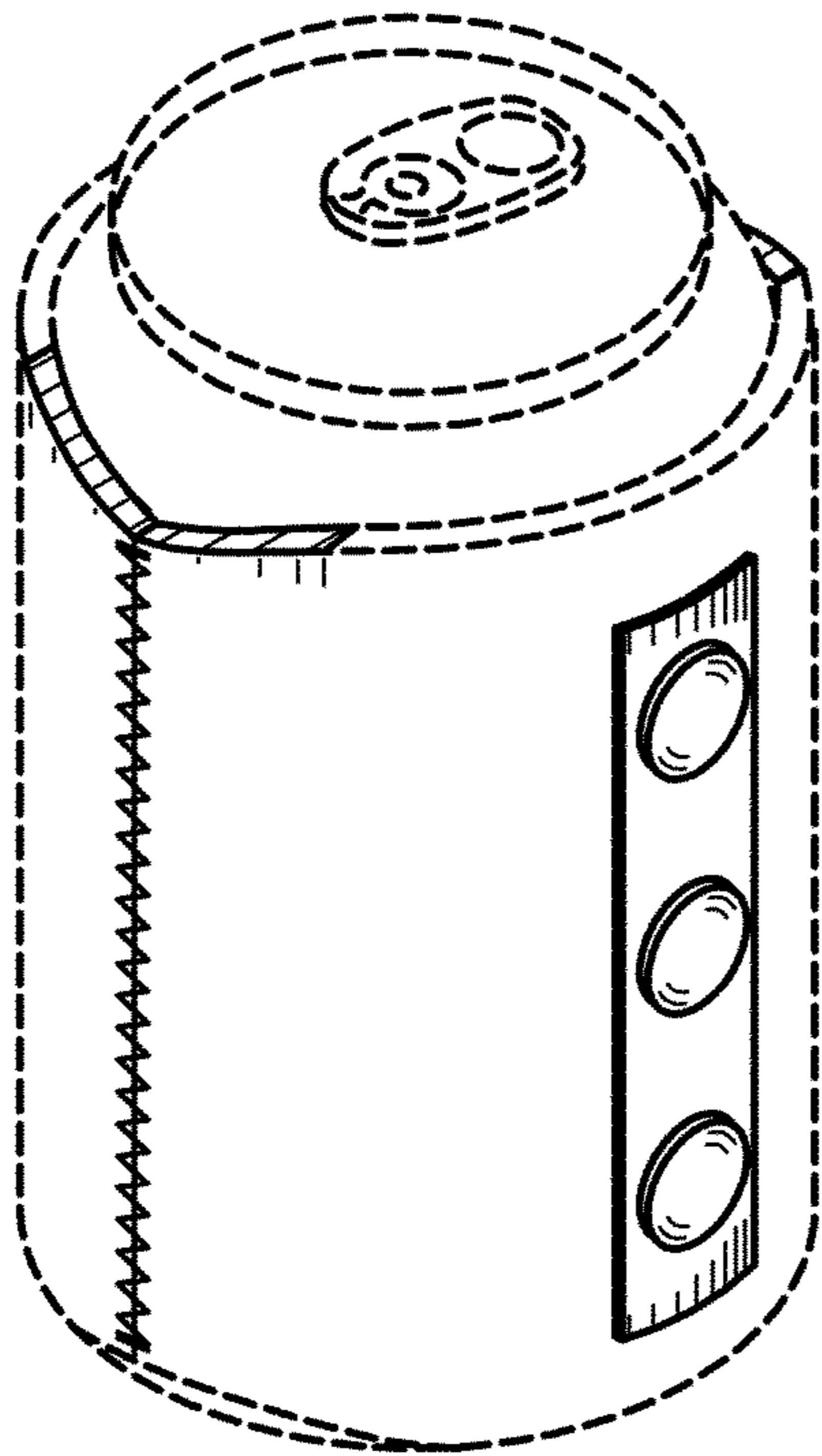

FIG. 7

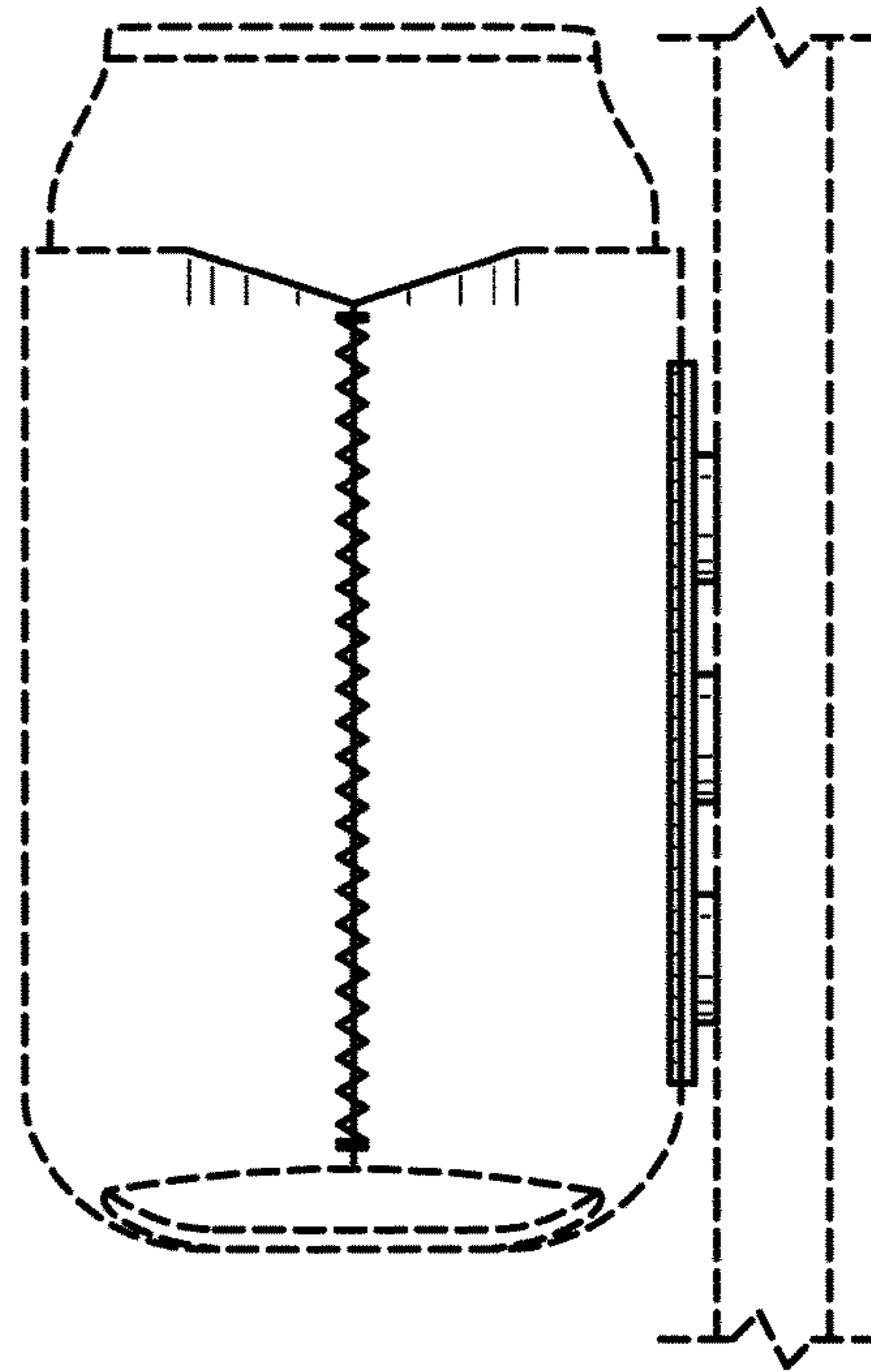

FIG. 8