



US00D829035S

(12) **United States Design Patent**  
**Measom et al.**

(10) **Patent No.:** **US D829,035 S**  
(45) **Date of Patent:** **\*\* Sep. 25, 2018**

(54) **SMOKER**  
(71) Applicant: **Logan Outdoor Products, LLC**, Hyde Park, UT (US)  
(72) Inventors: **Ty Measom**, Logan, UT (US); **Brett Bennett**, Mantua, UT (US)  
(73) Assignee: **Logan Outdoor Products, LLC**, Hyde Park, UT (US)

D688,507 S \* 8/2013 Hill ..... D7/323  
D693,166 S \* 11/2013 Measom ..... D7/350.1  
8,833,360 B2 \* 9/2014 Knight ..... A47J 37/0754  
126/21 A  
D715,084 S \* 10/2014 Hill ..... D7/332  
D720,569 S \* 1/2015 Hill ..... D7/334  
D775,489 S \* 1/2017 Zemel ..... D7/332  
9,907,435 B2 \* 3/2018 Kohler ..... A47J 37/0763  
2001/0035176 A1 \* 11/2001 Bush, III ..... A47J 37/0704  
126/25 R

(\*\*) Term: **15 Years**

\* cited by examiner

(21) Appl. No.: **29/590,152**

*Primary Examiner* — Sheryl Lane  
*Assistant Examiner* — Nicole C Shiflet

(22) Filed: **Jan. 7, 2017**

(74) *Attorney, Agent, or Firm* — Preston P. Frischknecht;  
Project CIP

(51) **LOC (11) Cl.** ..... **07-02**

(57) **CLAIM**

(52) **U.S. Cl.**  
USPC ..... **D7/332**

The ornamental design for a smoker, as shown and described.

(58) **Field of Classification Search**  
USPC ..... D7/402–409, 332–337, 323, 338, 339,  
D7/350.1  
CPC ..... A47J 37/07; A47J 37/0704; A47J 37/0763  
See application file for complete search history.

**DESCRIPTION**

(56) **References Cited**

FIG. 1 is an isometric view;  
FIG. 2 is a front view;  
FIG. 3 is a back view;  
FIG. 4 is a left side view;  
FIG. 5 is a right side view;  
FIG. 6 is a top view; and,  
FIG. 7 is a bottom view.  
The broken lines showing portions of the article form no part of the claimed design.

**U.S. PATENT DOCUMENTS**

D280,967 S \* 10/1985 Wrighton ..... D7/339  
D418,005 S \* 12/1999 Morris ..... D7/338  
D480,596 S \* 10/2003 Dellinger ..... D7/335  
D534,755 S \* 1/2007 Knight ..... D7/332  
D539,071 S \* 3/2007 O'Brien ..... D7/333

**1 Claim, 6 Drawing Sheets**

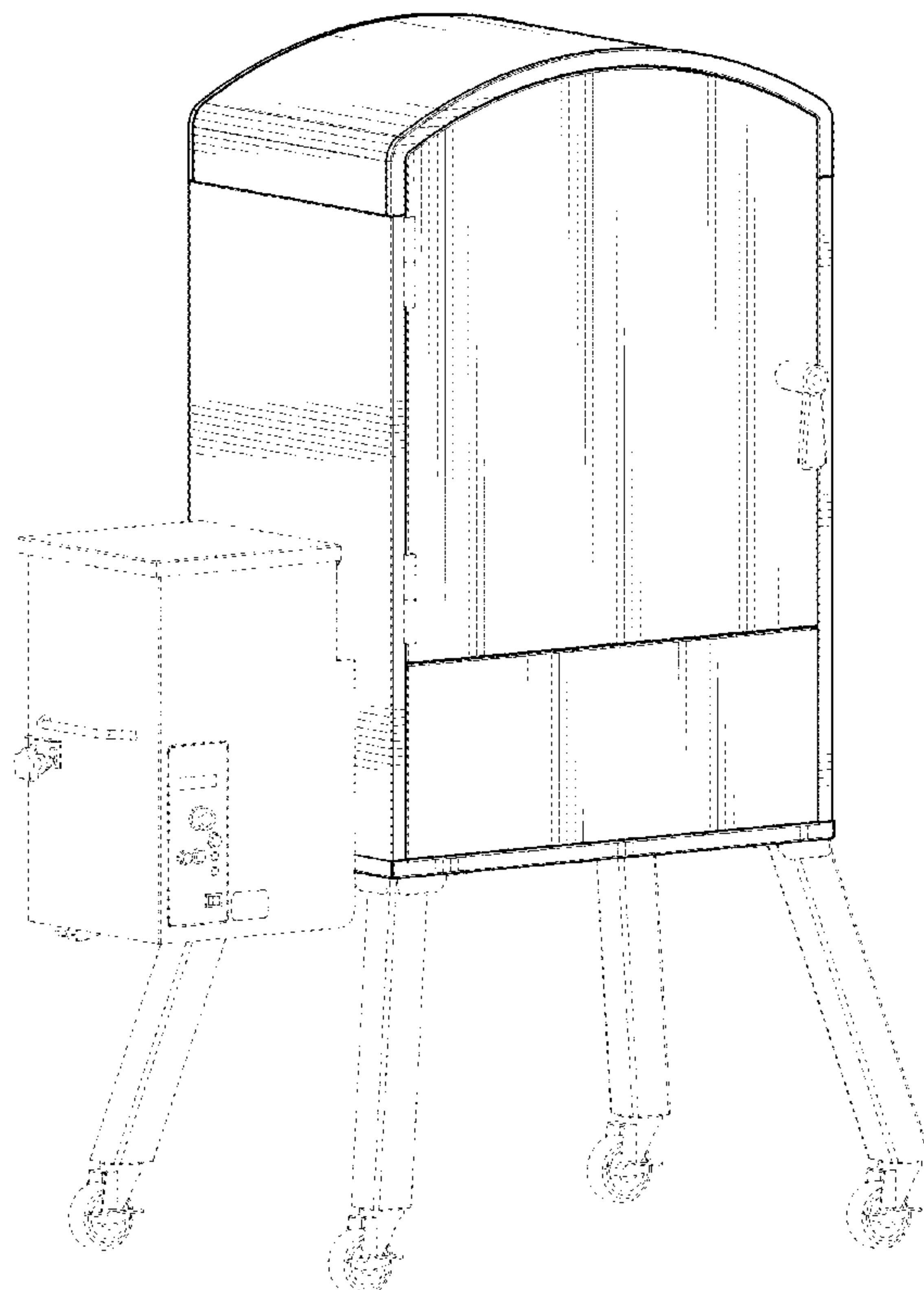

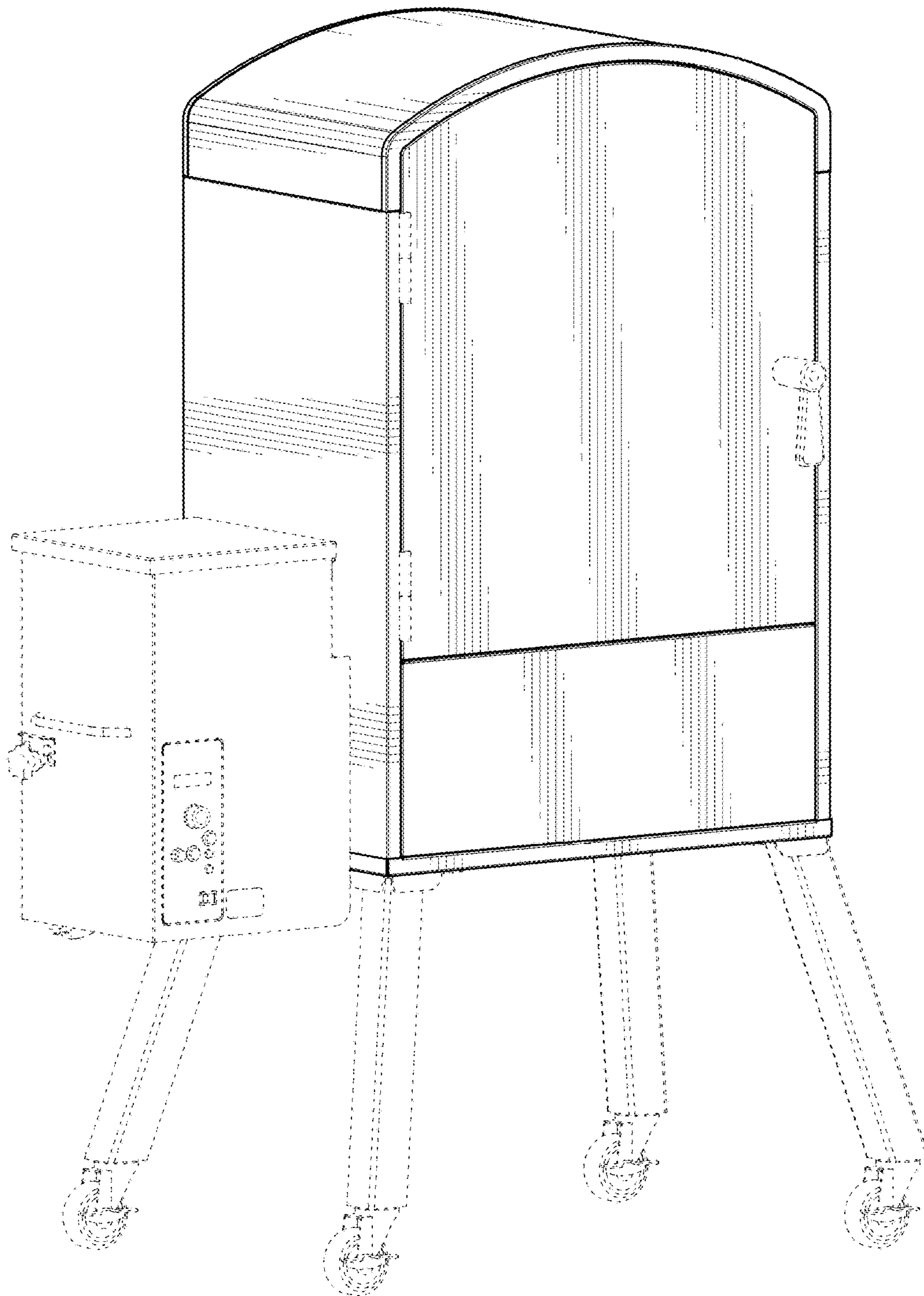

FIG. 1

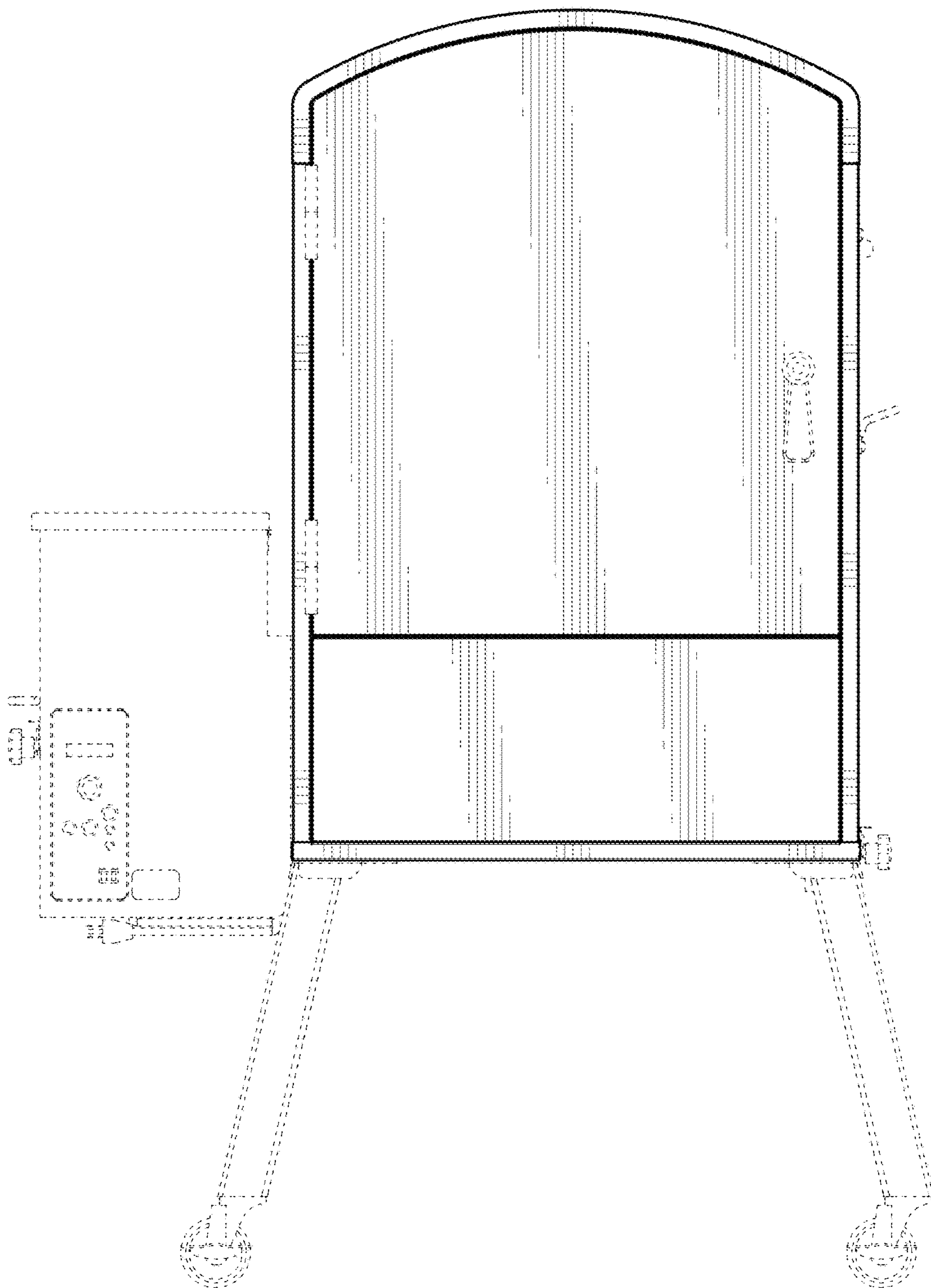

FIG. 2

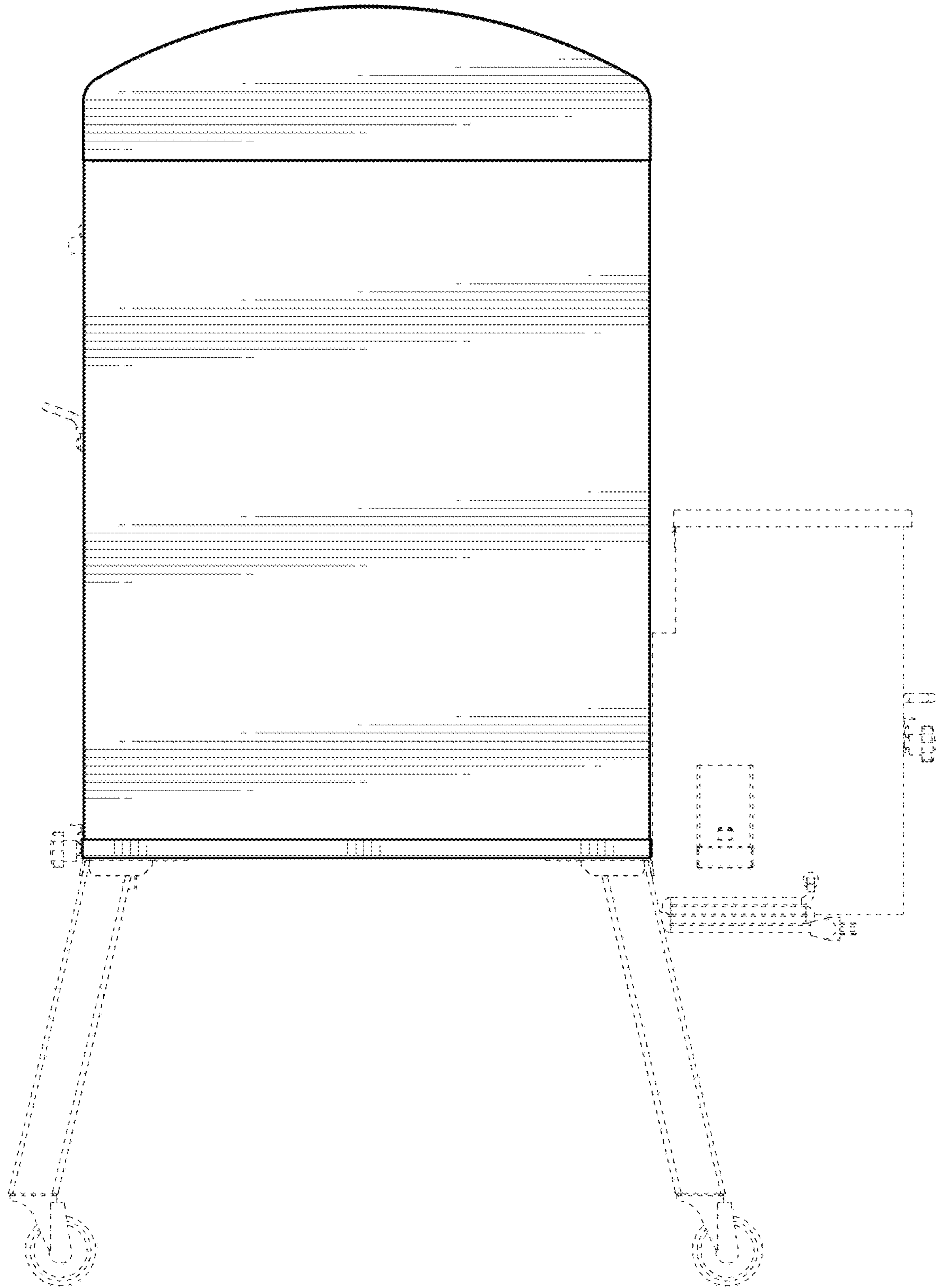
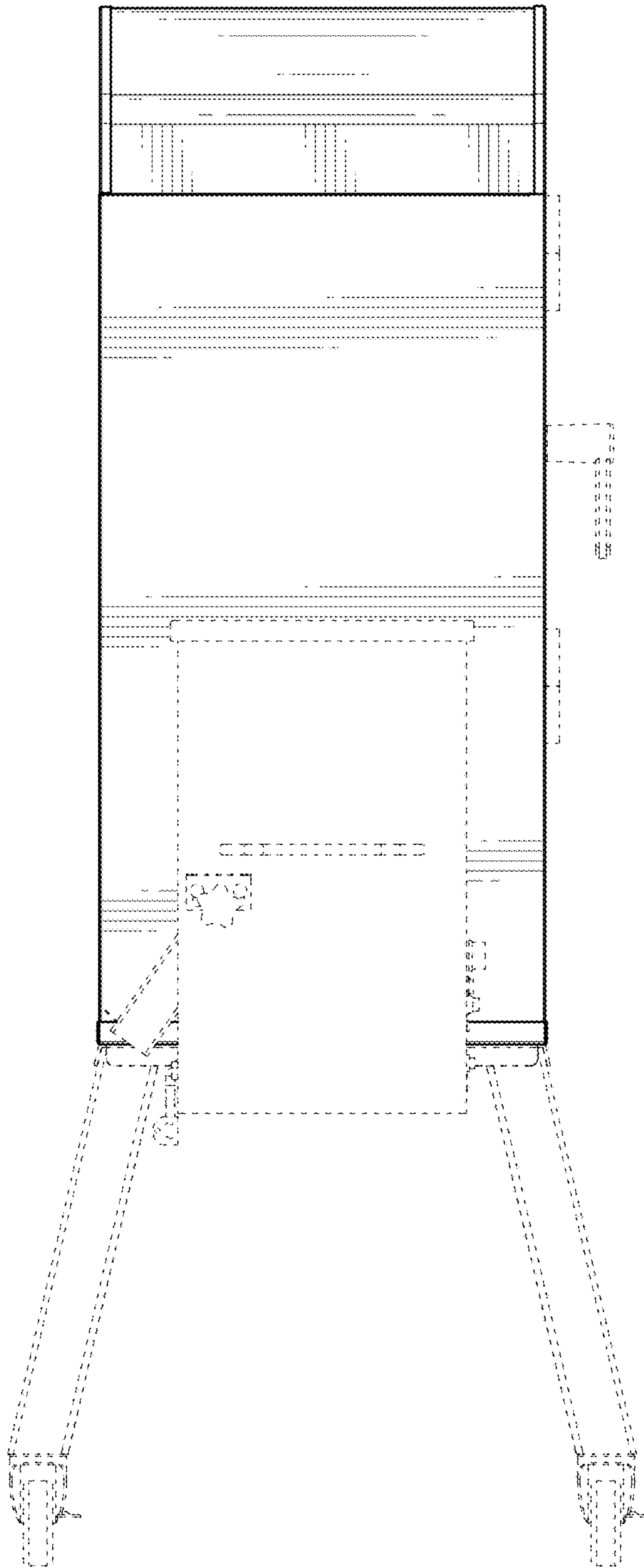

FIG. 3





**FIG. 4**

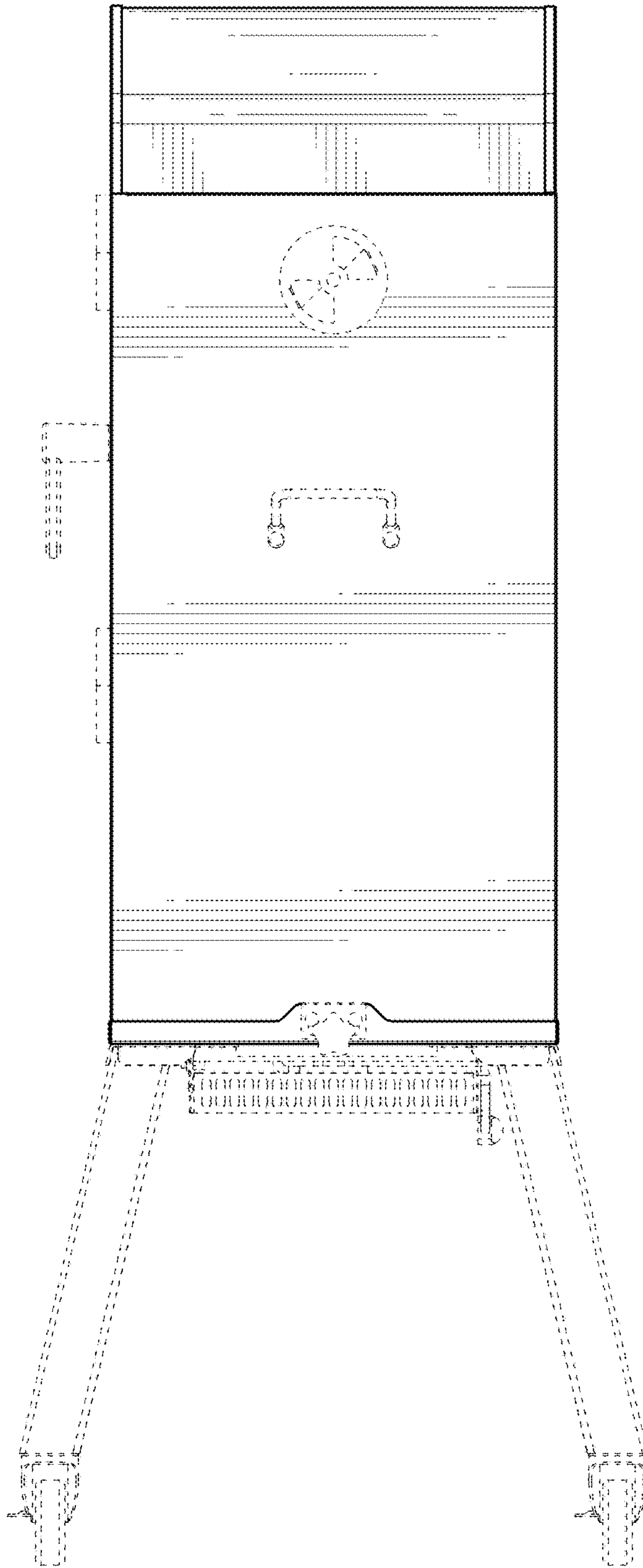

FIG. 5

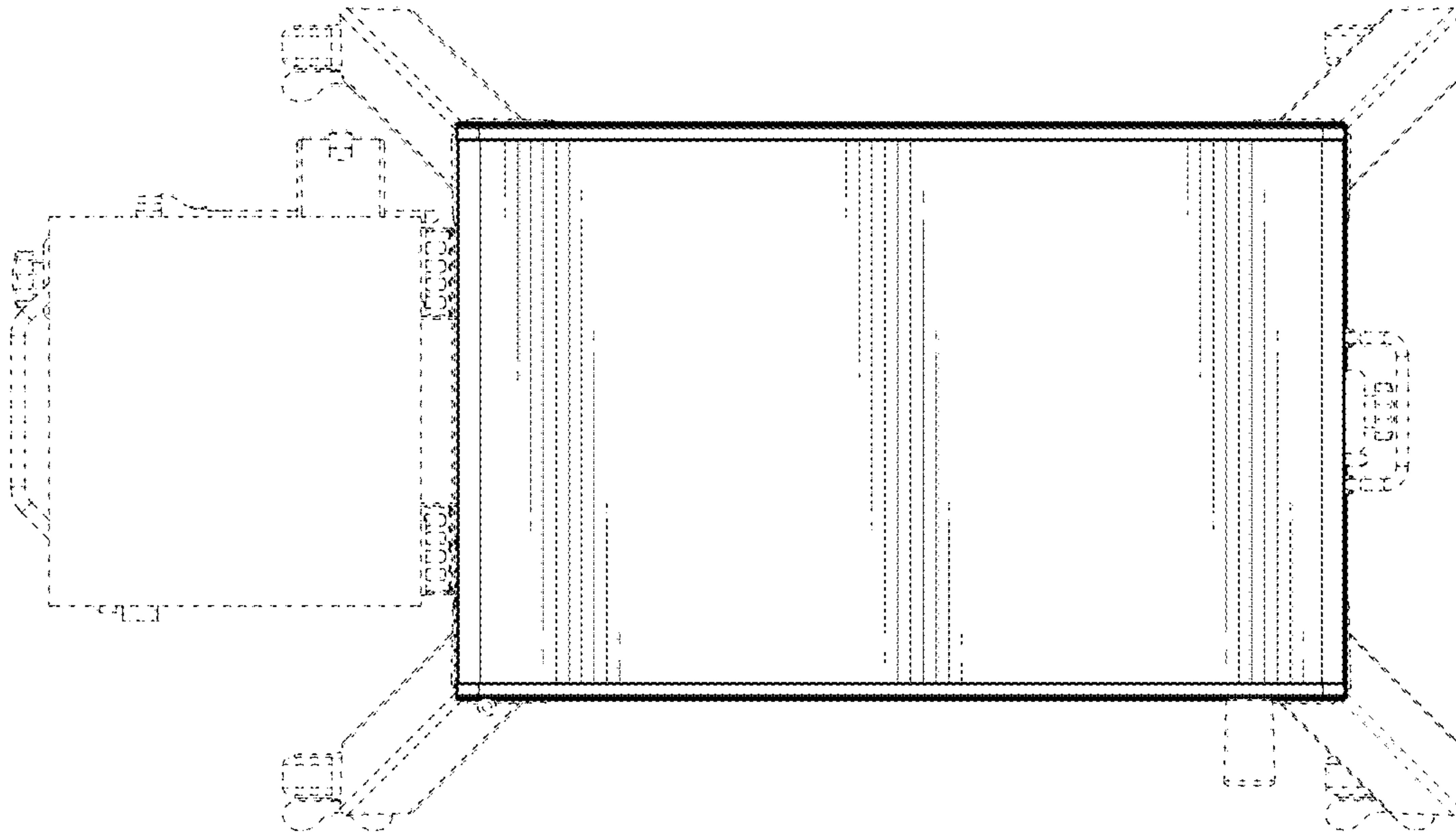

FIG. 6

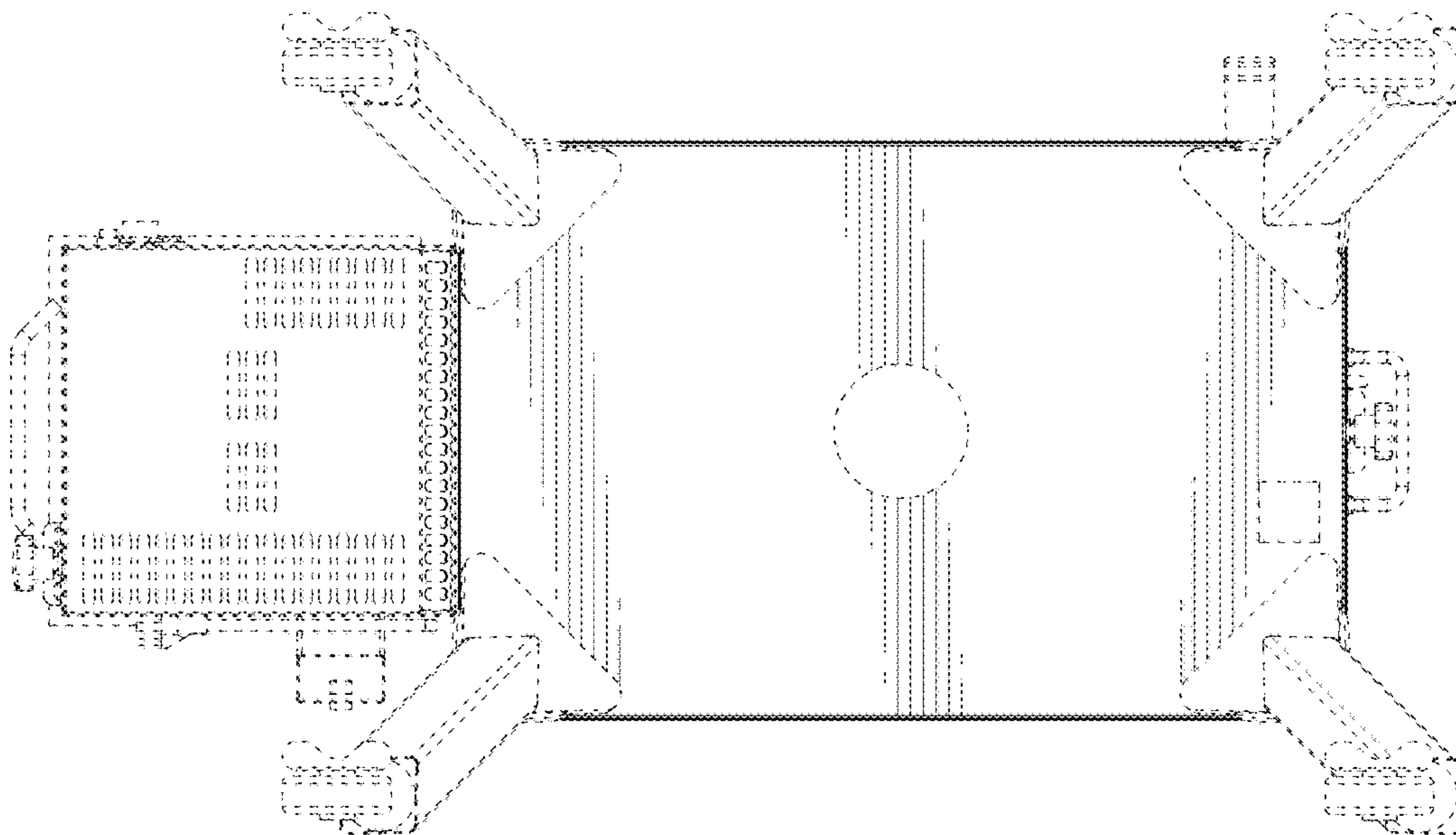

FIG. 7