



US00D828997S

(12) **United States Design Patent** (10) **Patent No.:** **US D828,997 S**  
**Lehan** (45) **Date of Patent:** **\*\* Sep. 25, 2018**

(54) **SLING POUCH**

(71) Applicant: **Lisbeth Lehan**, Niwot, CO (US)

(72) Inventor: **Lisbeth Lehan**, Niwot, CO (US)

(73) Assignee: **LILLEbaby, LLC**, Boulder, CO (US)

(\*\*) Term: **15 Years**

(21) Appl. No.: **29/606,783**

(22) Filed: **Jun. 7, 2017**

(51) **LOC (11) Cl.** ..... **03-01**

(52) **U.S. Cl.**  
USPC ..... **D3/226**

(58) **Field of Classification Search**  
USPC ..... D3/226, 215, 218-219, 224, 221, 228;  
224/240-241, 245, 578, 584, 674, 904,  
224/929-930  
CPC . A45C 11/00; A45C 11/22; A45F 5/00; A45F  
5/02

See application file for complete search history.

(56) **References Cited**

**U.S. PATENT DOCUMENTS**

5,114,061 A \* 5/1992 Brady ..... A45C 11/22  
224/194  
D546,556 S \* 7/2007 Aaron ..... D3/218  
D668,039 S \* 10/2012 Graham ..... D3/218  
D761,011 S \* 7/2016 Grote ..... D3/226  
9,572,409 B2 \* 2/2017 Pidgeon ..... A45C 11/00

\* cited by examiner

*Primary Examiner* — Catherine R Oliver-Garcia  
(74) *Attorney, Agent, or Firm* — Lathrop Gage LLP

(57) **CLAIM**

The ornamental design for a sling pouch, as shown and described.

**DESCRIPTION**

FIG. 1 is a front, side and bottom perspective view of a sling pouch;  
FIG. 2 is a front elevation view thereof;  
FIG. 3 is a rear elevation view thereof;  
FIG. 4 is a left side elevation view thereof;  
FIG. 5 is a right side elevation view thereof;  
FIG. 6 is a top plan view thereof;  
FIG. 7 is a bottom plan view thereof;  
FIG. 8 is a left side view of the sling pouch showing the flexible nature of the rear pad providing an aperture between the pad and pouch portion of the sling pouch;  
FIG. 9 is an environmental view of the sling pouch when attached to a sling; and,  
FIG. 10 is a top view of the sling pouch in a squeezed configuration thereby creating an aperture between the front pouch and rear flap to allow attachment to a sling as shown in FIG. 9.  
The broken lines depict environmental structure that are for illustrative purposes only and form no part of the claimed design.

**1 Claim, 7 Drawing Sheets**

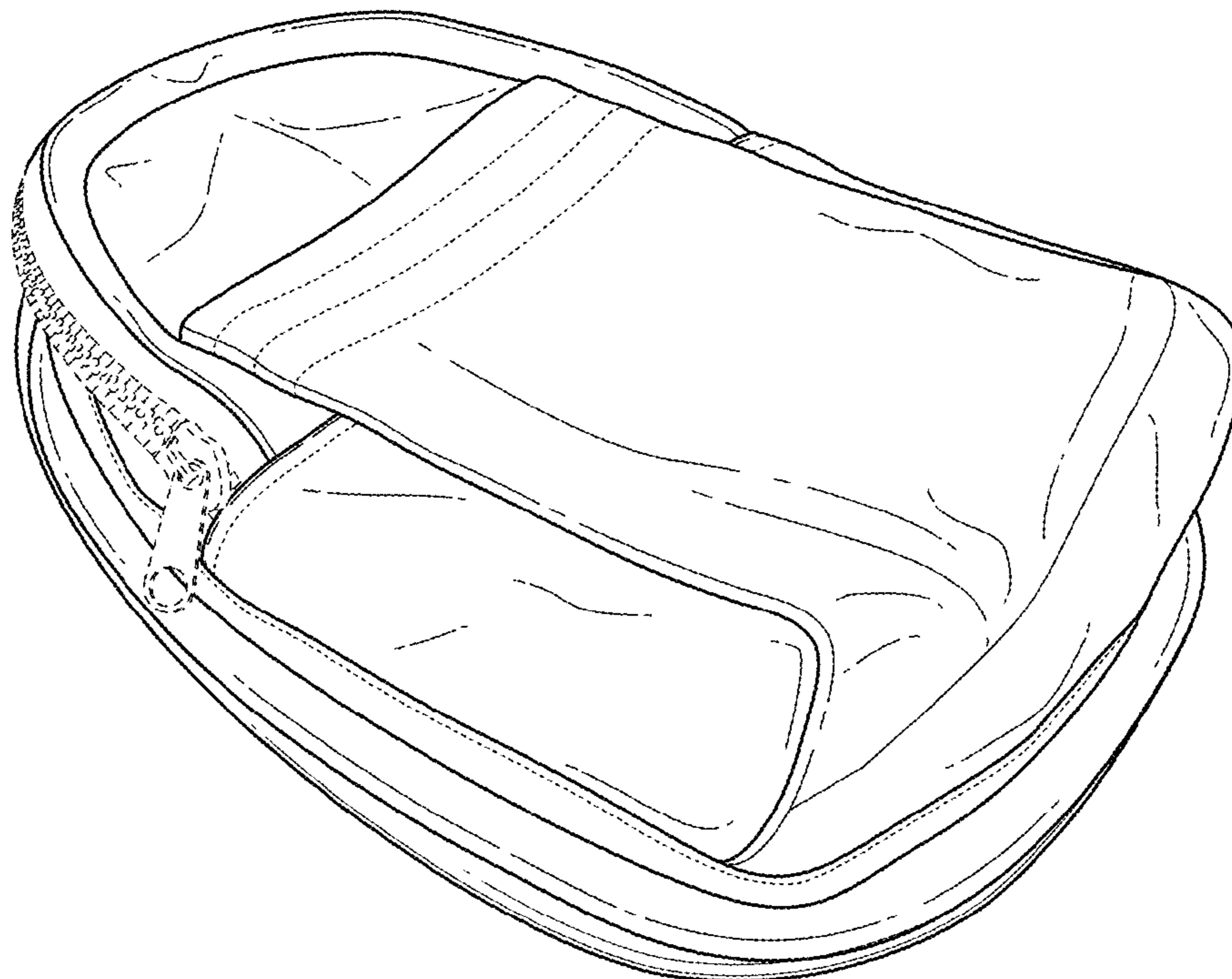

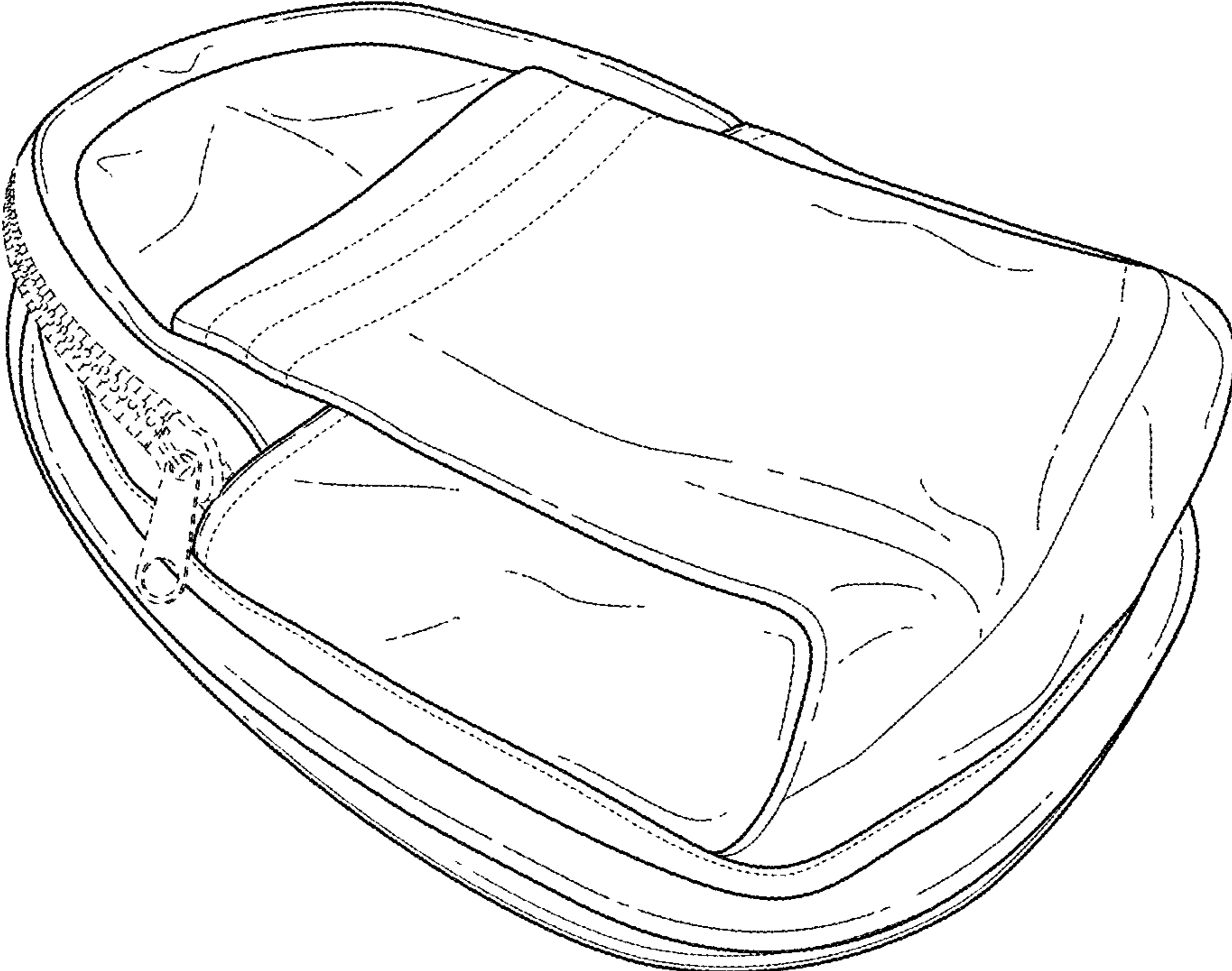

FIG. 1

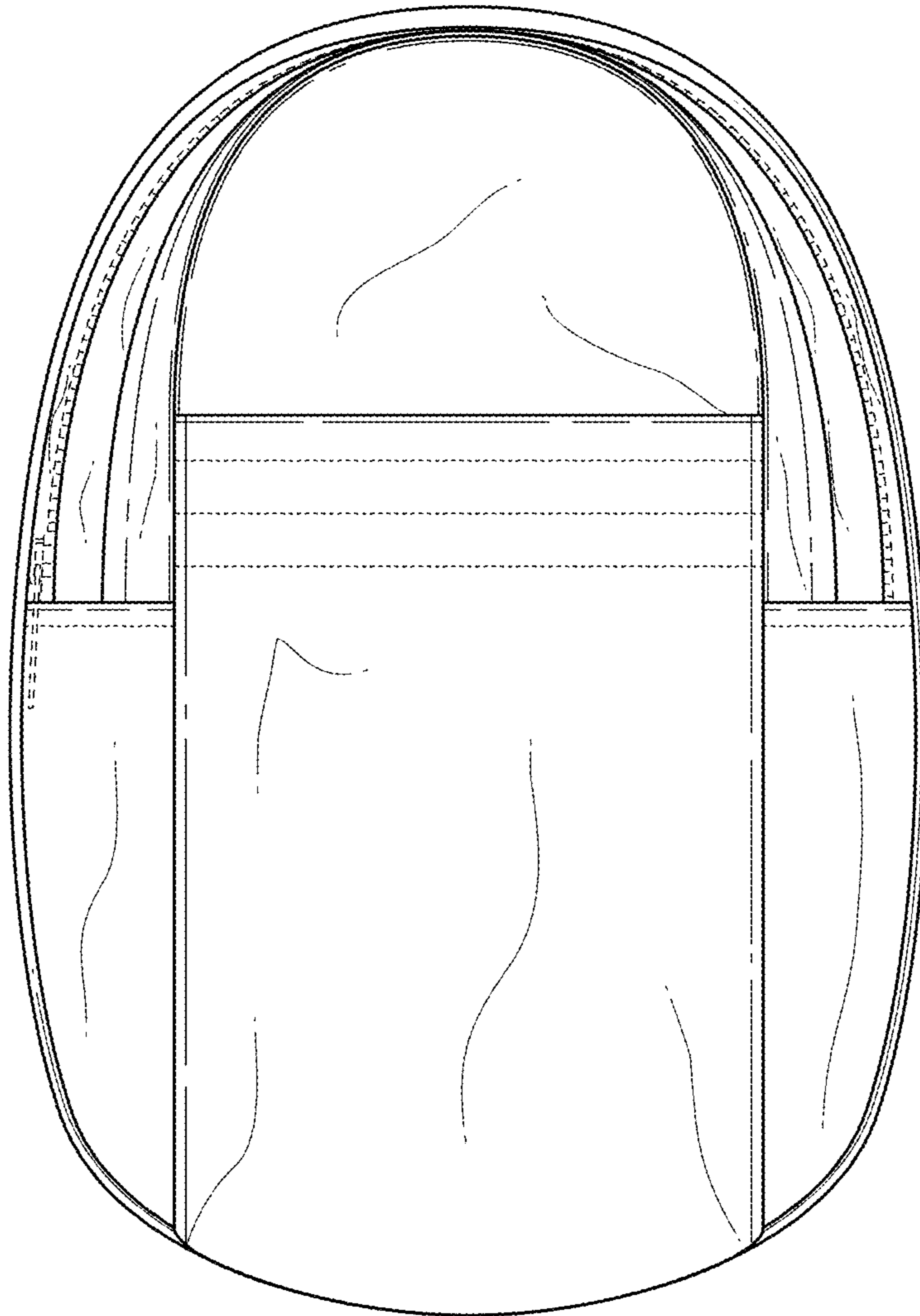

FIG. 2

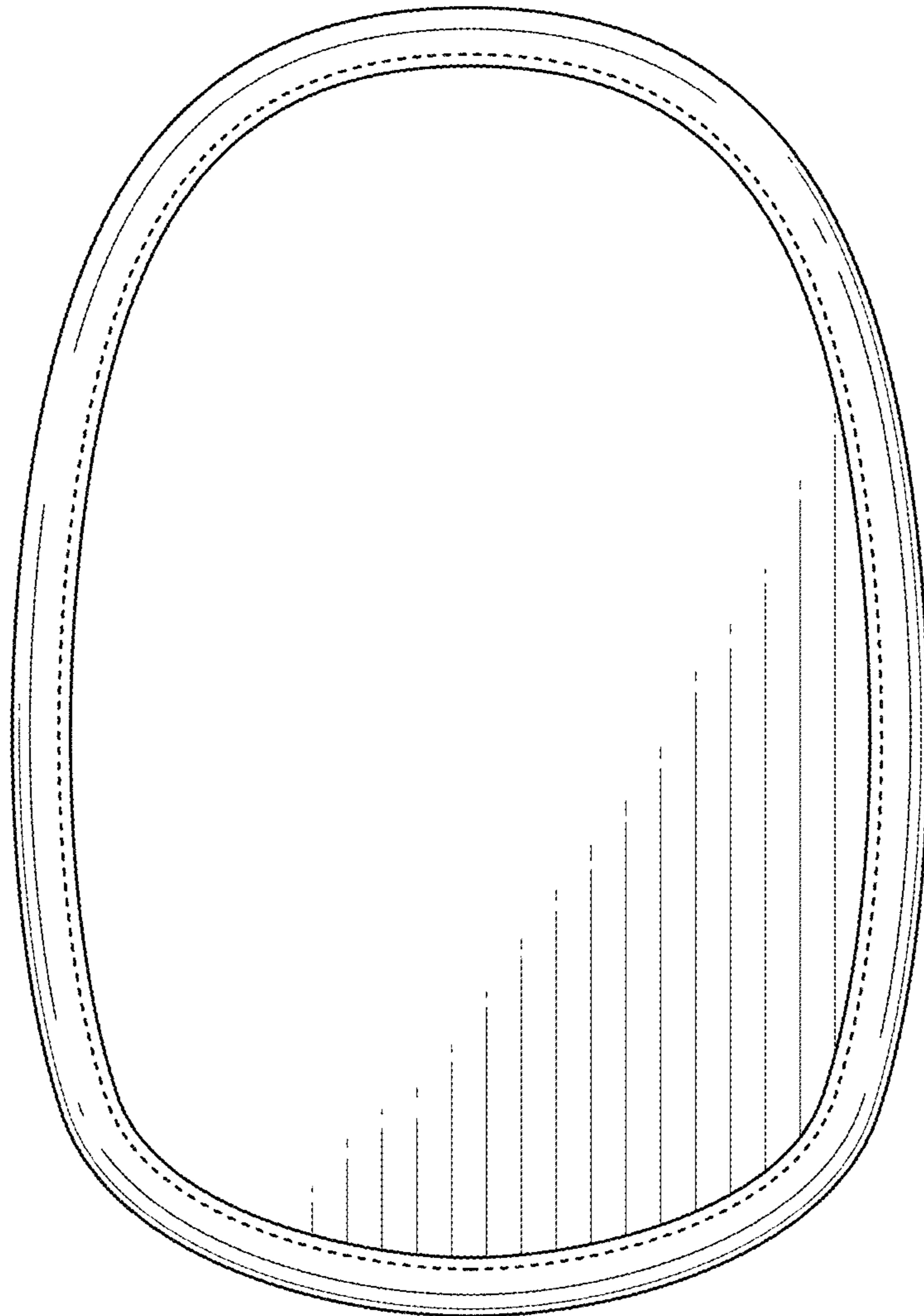

FIG. 3

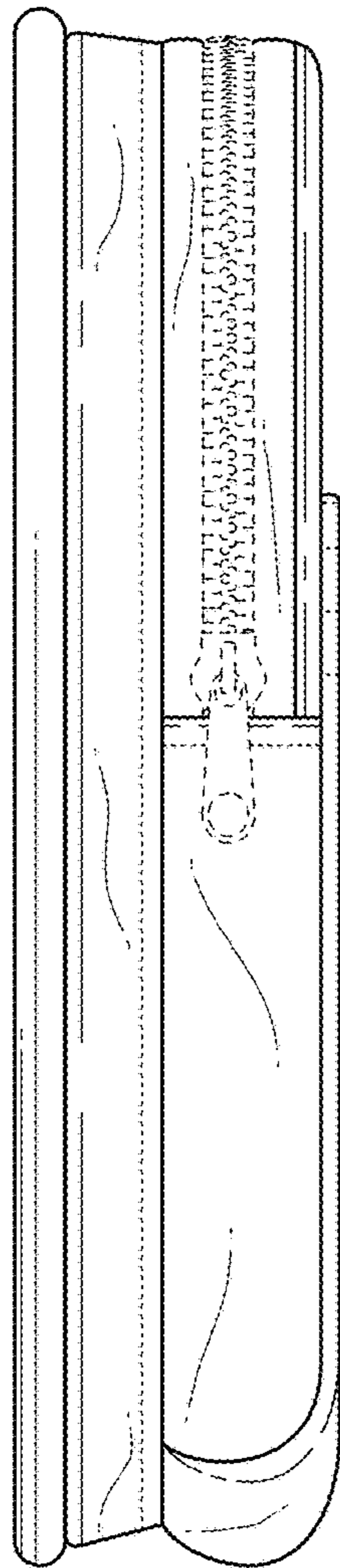

FIG. 4

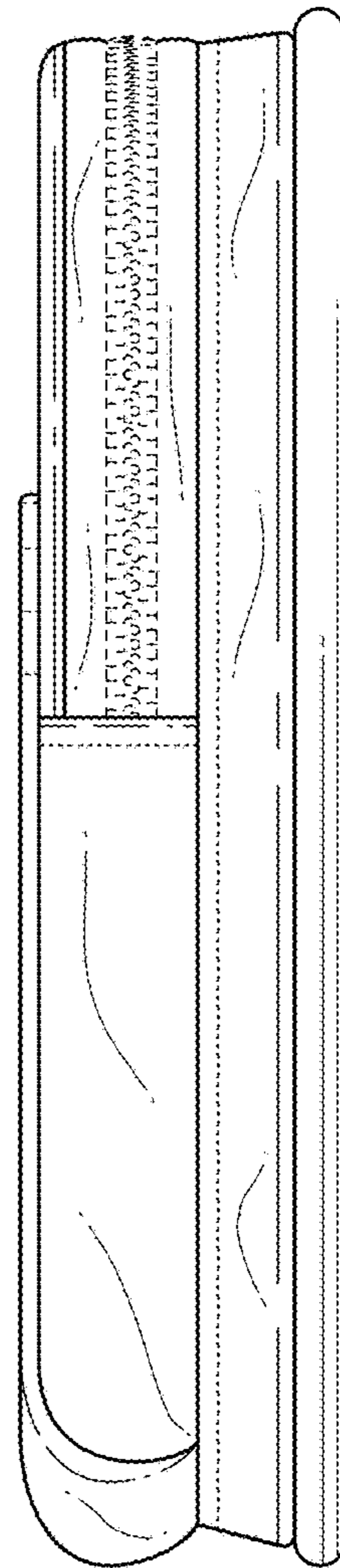

FIG. 5

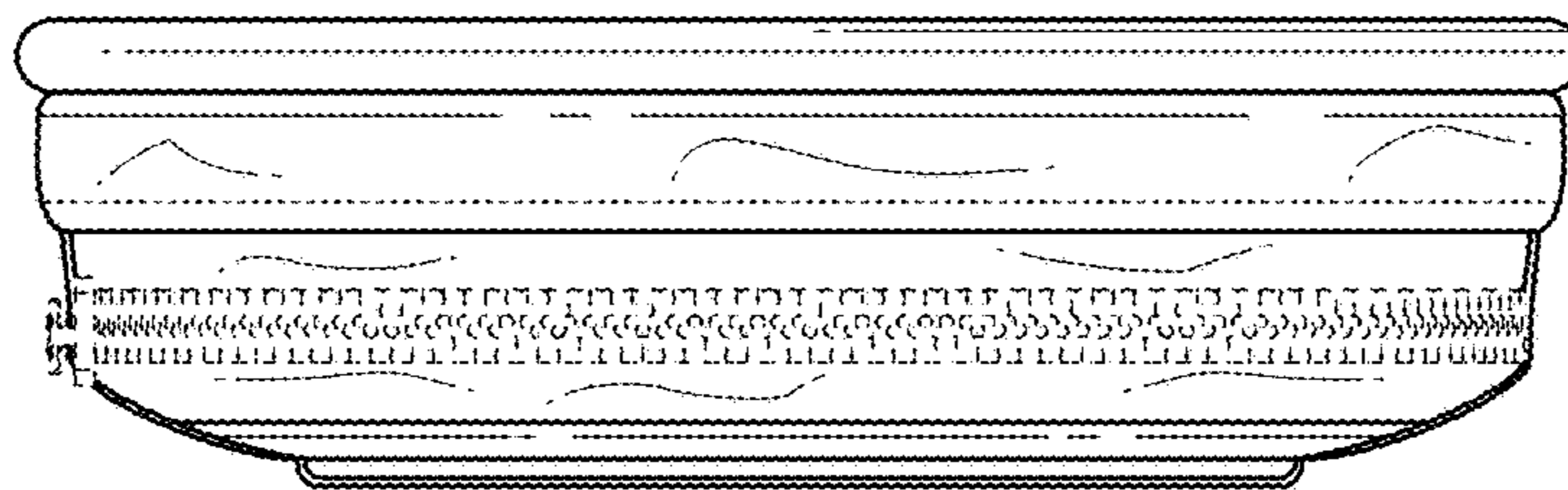

FIG. 6

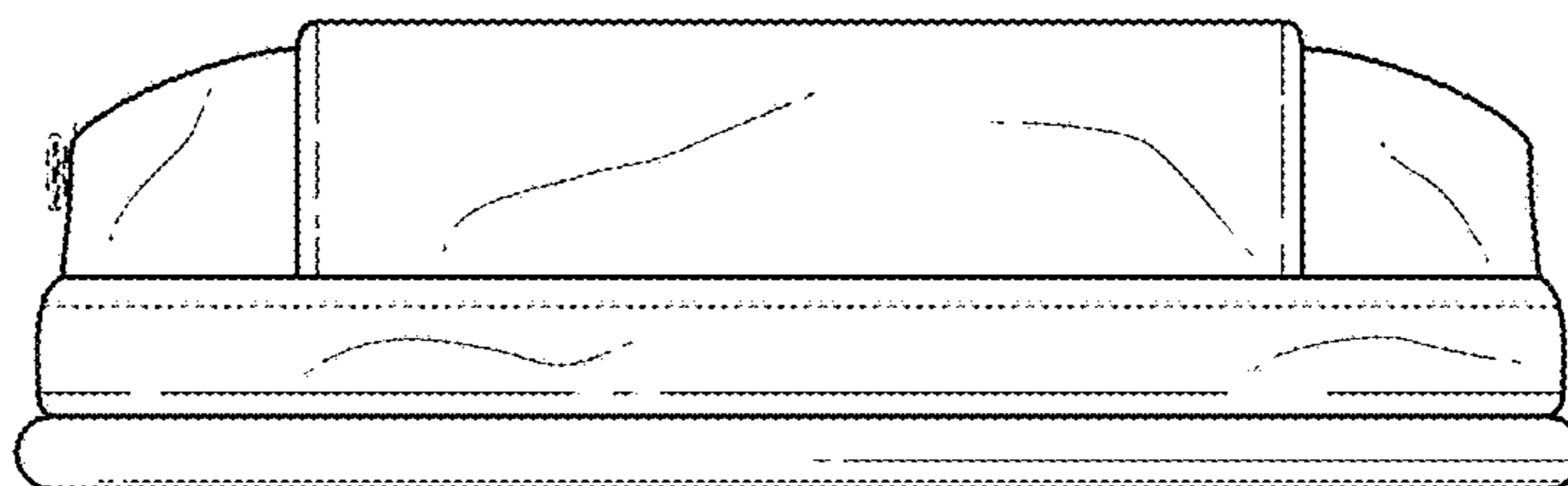

FIG. 7

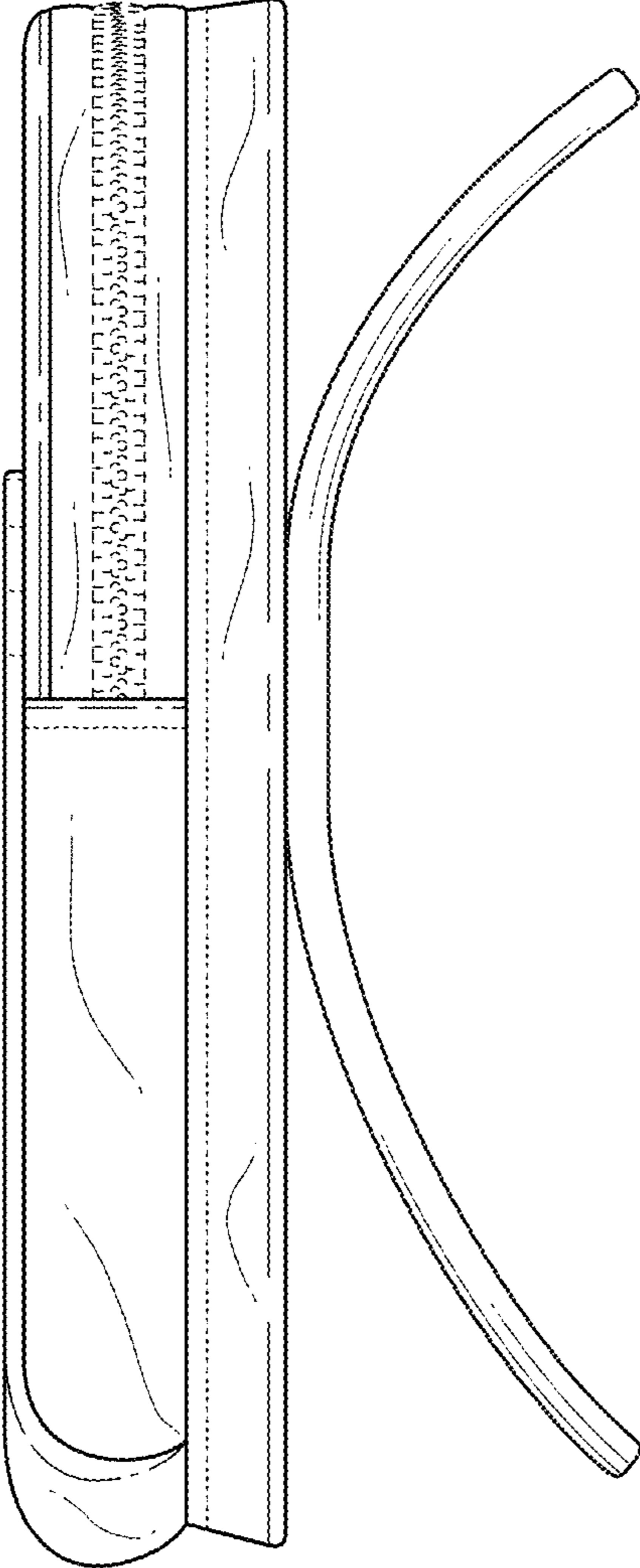

FIG. 8

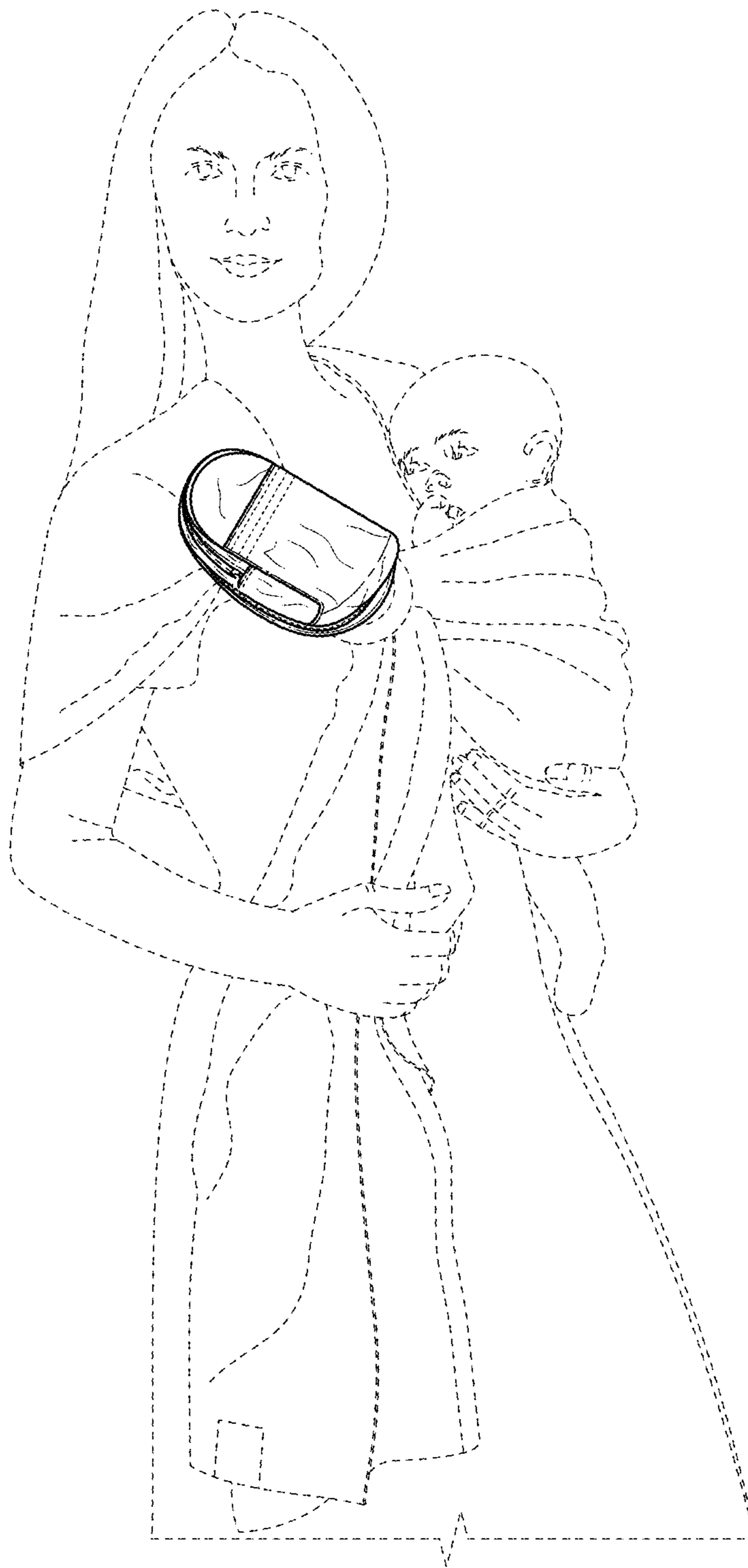

FIG. 9

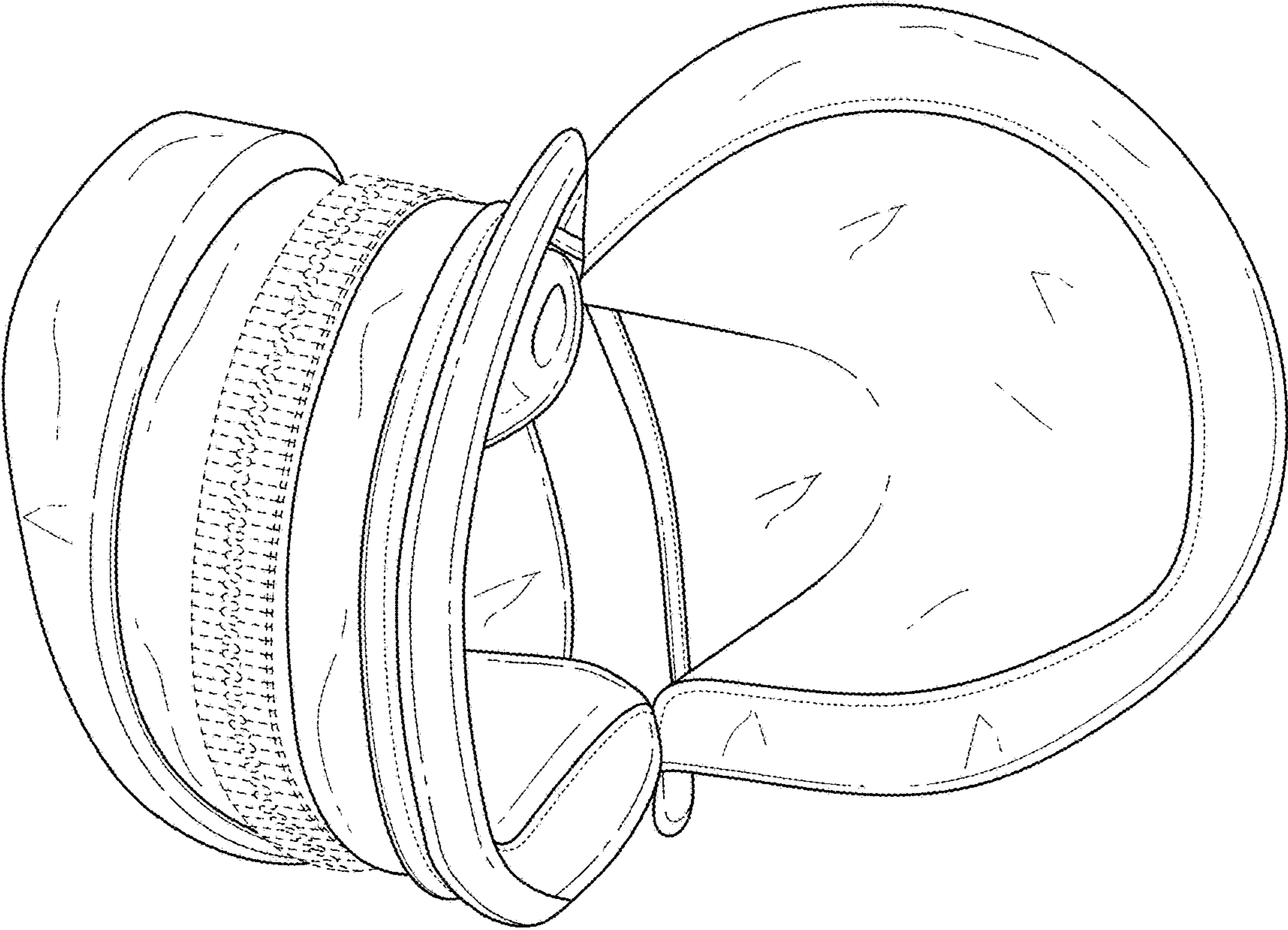

FIG. 10