

US00D828890S

(12) **United States Design Patent**
Niswonger

(10) **Patent No.:** **US D828,890 S**

(45) **Date of Patent:** **** Sep. 18, 2018**

- (54) **GOLF FERRULE**
- (71) Applicant: **John O. H. Niswonger**, Agoura Hills, CA (US)
- (72) Inventor: **John O. H. Niswonger**, Agoura Hills, CA (US)
- (**) Term: **15 Years**
- (21) Appl. No.: **29/635,883**
- (22) Filed: **Feb. 5, 2018**
- (51) **LOC (11) Cl.** **21-02**
- (52) **U.S. Cl.**
USPC **D21/796**
- (58) **Field of Classification Search**
USPC D21/789, 796; D11/181–182
CPC A63B 57/357; A63B 57/40
See application file for complete search history.

- 7,500,919 B2 * 3/2009 Priegel A63B 57/357
473/176
- D642,958 S * 8/2011 Long D11/182
- 8,147,346 B2 * 4/2012 Long A63B 57/357
473/176
- 8,858,353 B2 * 10/2014 Wiggins A63B 57/00
473/176
- D724,685 S * 3/2015 Carroll D21/789
- 9,017,181 B2 * 4/2015 Evans A63B 57/357
473/176
- D817,420 S * 5/2018 Keeley D21/756
- 2003/0096659 A1 * 5/2003 Webb A63B 57/357
473/174
- 2009/0137331 A1 * 5/2009 Hansen A63B 57/357
473/176

* cited by examiner

Primary Examiner — Mitchell I. Siegel

(74) *Attorney, Agent, or Firm* — Ronald L. Rohde

(57) **CLAIM**

The ornamental design for a golf ferrule, as shown and described.

(56) **References Cited**

U.S. PATENT DOCUMENTS

- 1,676,954 A * 7/1928 Kannemann A63B 57/357
473/176
- 3,348,797 A * 10/1967 Turbyfill A63B 57/357
248/539
- 4,114,879 A * 9/1978 Oiler A63B 57/357
473/177
- D257,245 S * 10/1980 Neal D11/181
- 5,451,045 A * 9/1995 Garske A63B 57/357
473/176
- D410,367 S * 6/1999 Applegate D21/789
- 5,964,667 A * 10/1999 Brookman A63B 57/357
473/176
- D431,624 S * 10/2000 Colonello D21/789
- 7,033,280 B2 * 4/2006 Hottle A63B 57/357
473/176
- D538,874 S * 3/2007 Ceruti D21/796
- 7,455,594 B1 * 11/2008 Priegel A63B 57/357
473/176

DESCRIPTION

FIG. 1 is perspective view of my new design for a golf ferrule;
 FIG. 2 is a front elevation view thereof;
 FIG. 3 is a rear elevation view thereof;
 FIG. 4 is a top view thereof;
 FIG. 5 is a bottom view thereof;
 FIG. 6 is a left side elevation view thereof;
 FIG. 7 is a right side elevation view thereof; and,
 FIG. 8 is a perspective view of FIG. 1 shown with an unclaimed fragmented flag pole inserted.
 The portions of the article shown in broken lines represent unclaimed portions of the article and form no part of the claimed design.

1 Claim, 8 Drawing Sheets

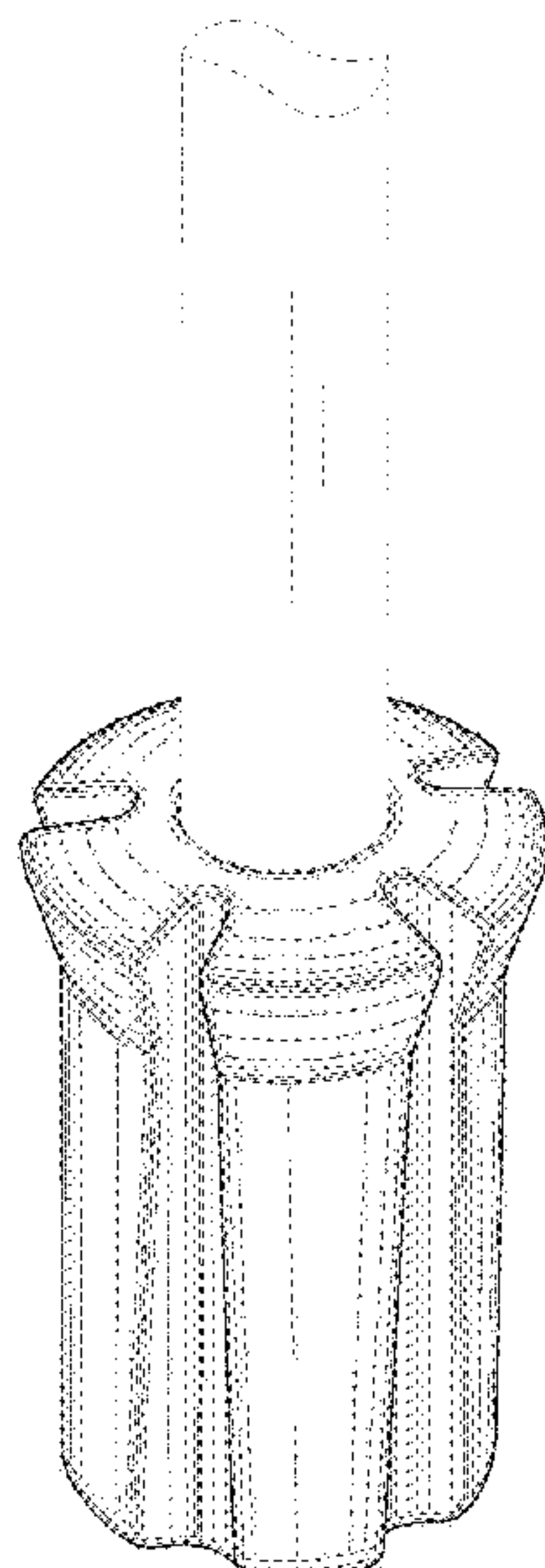

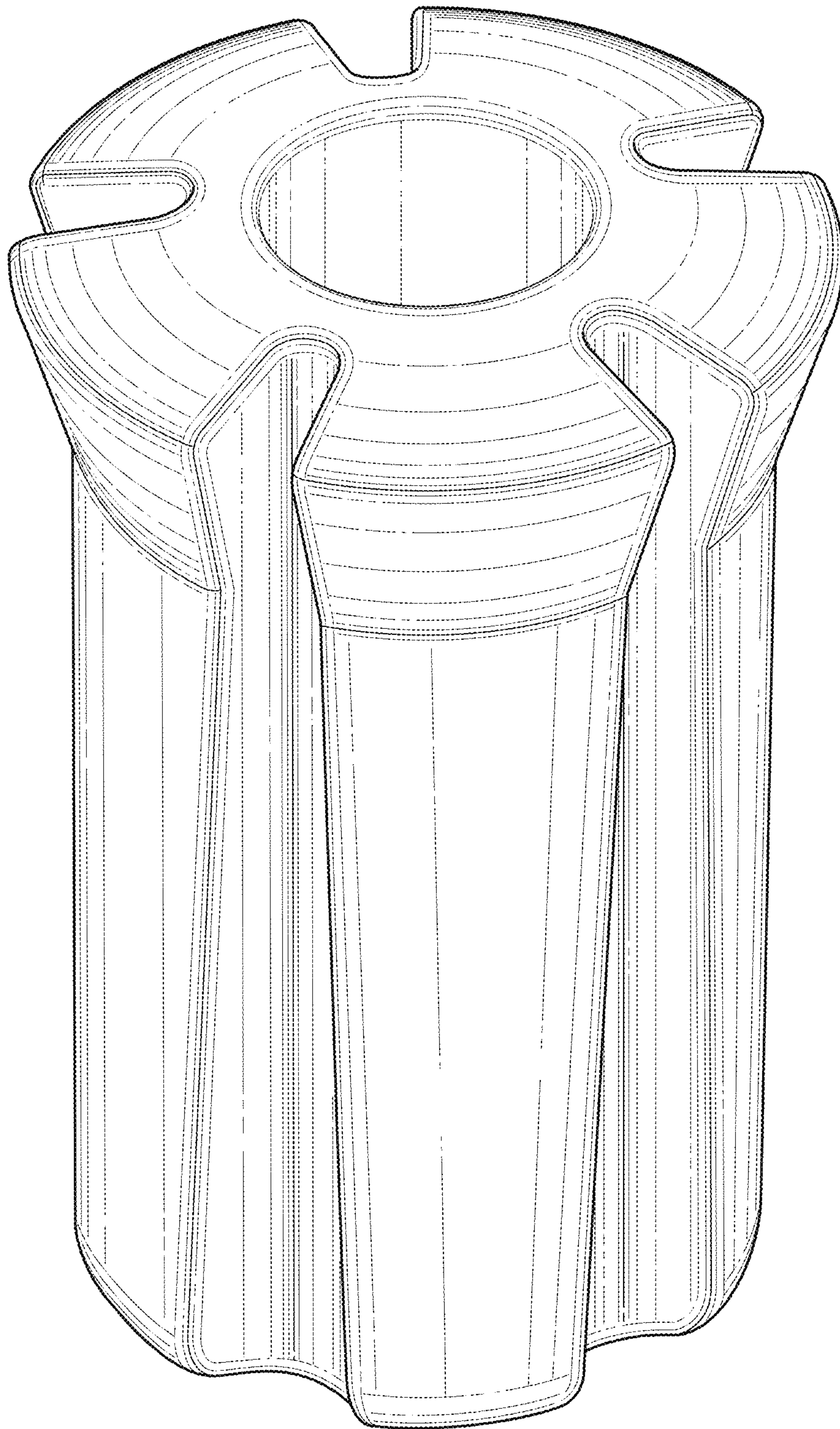

FIG. 1

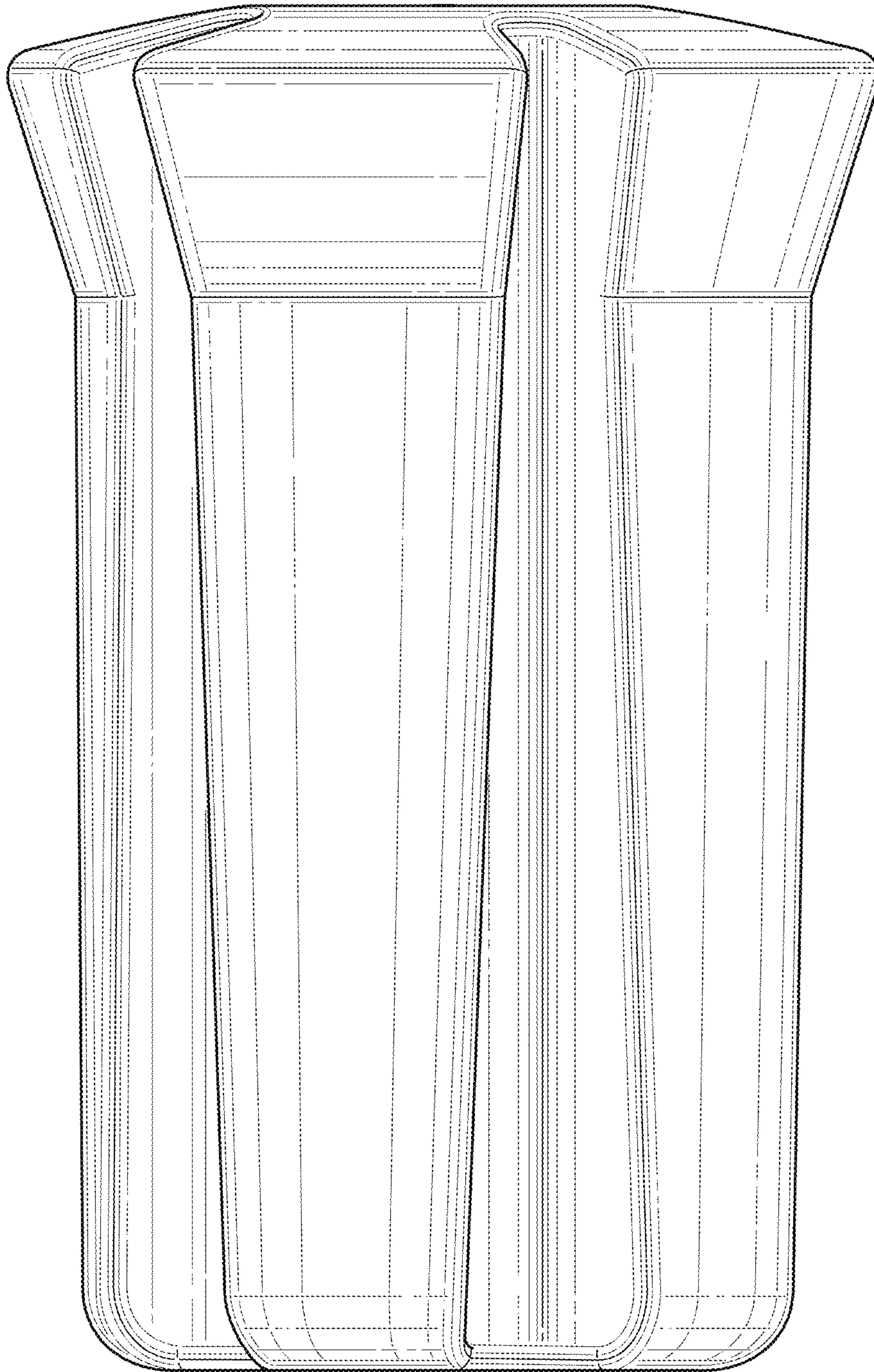

FIG. 2

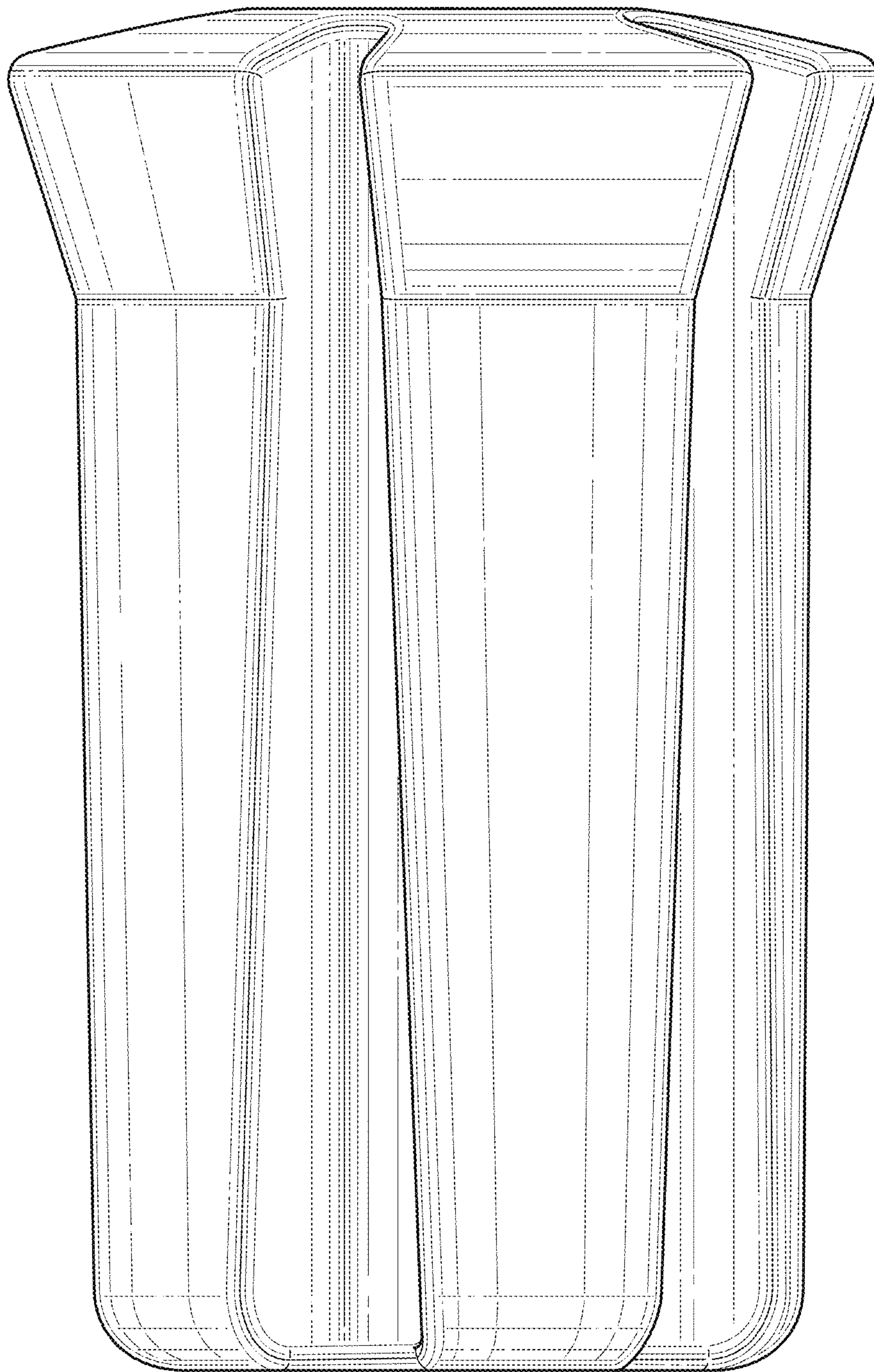

FIG. 3

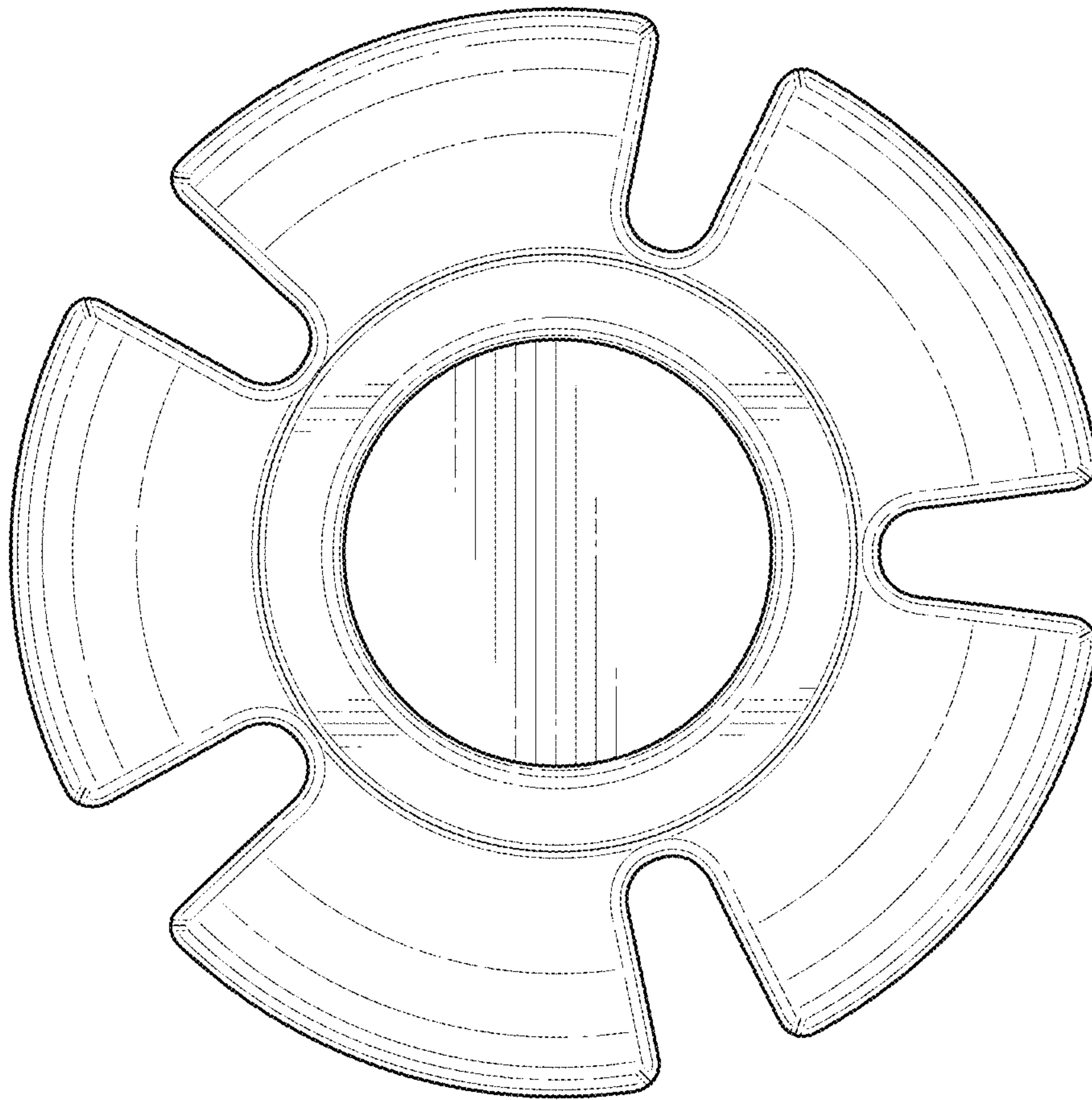

FIG. 4

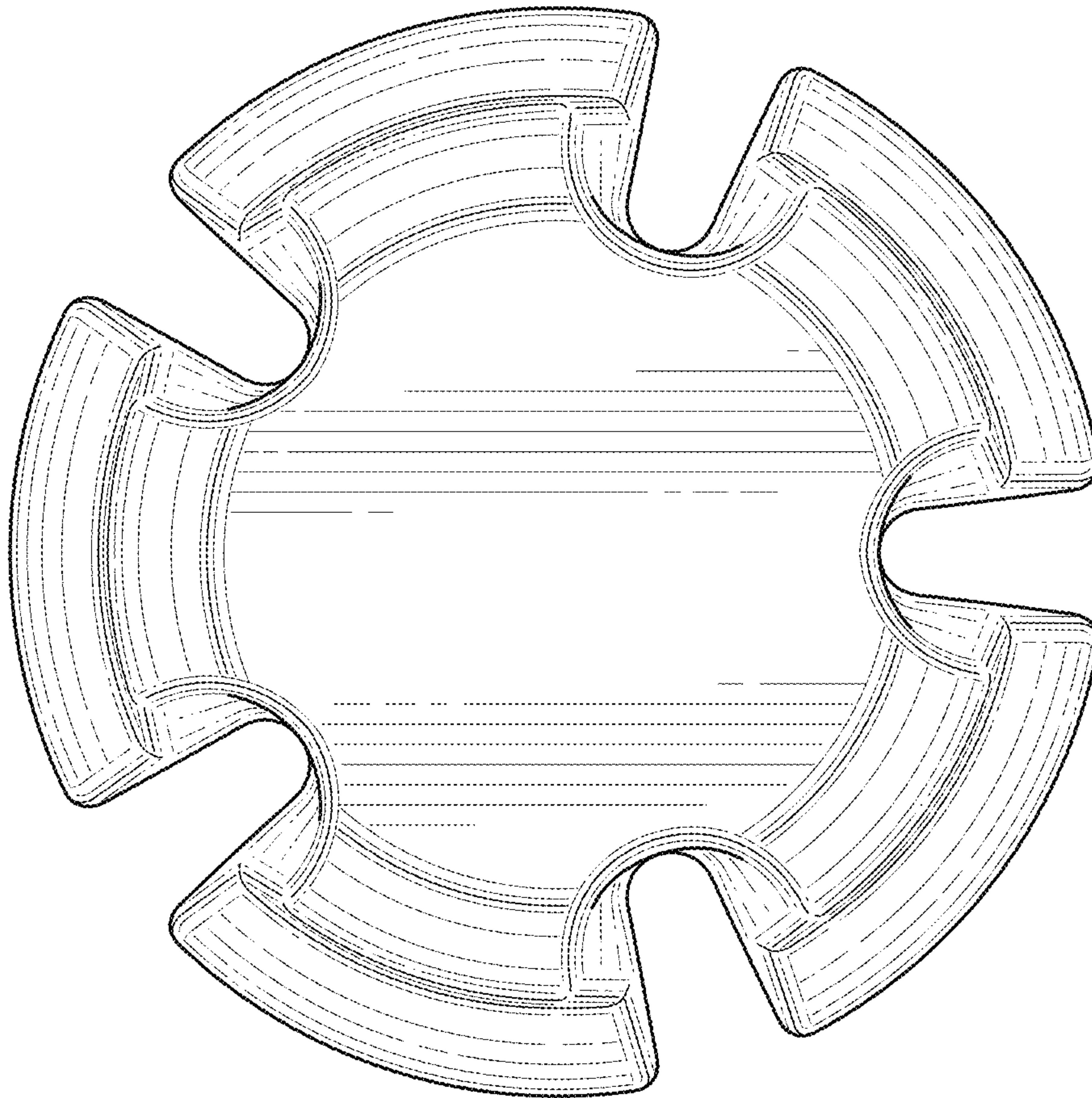

FIG. 5

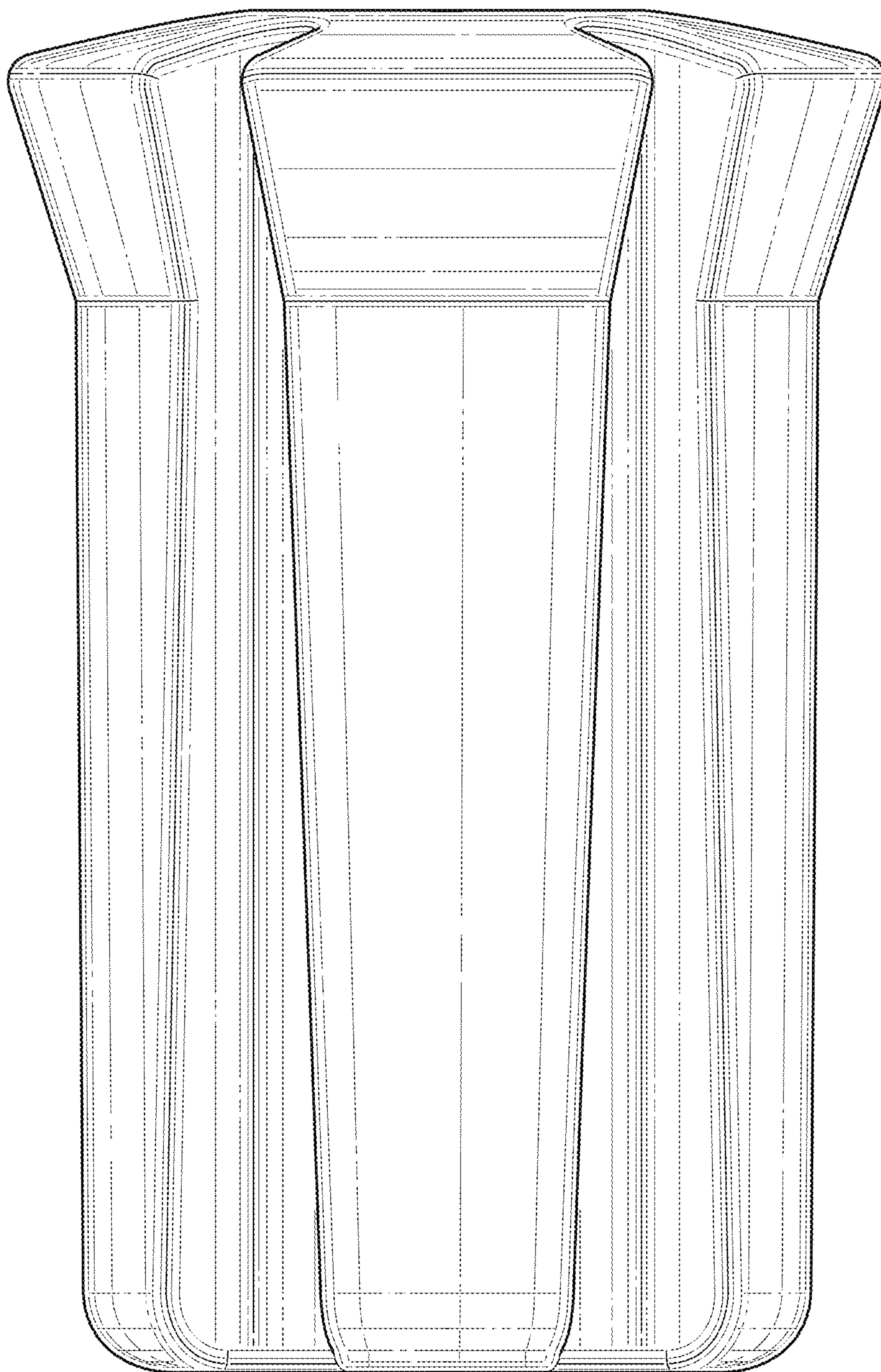

FIG. 6

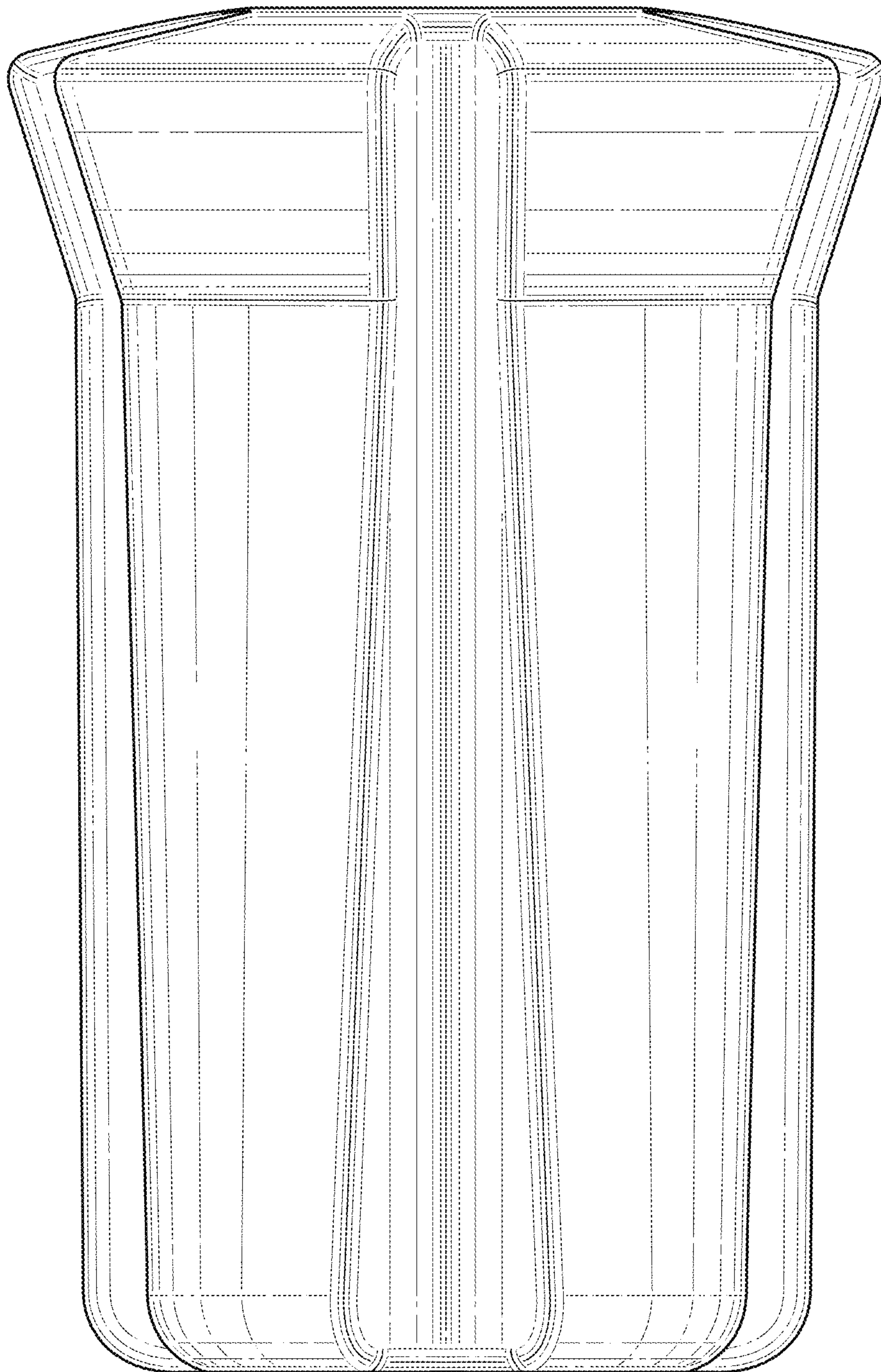

FIG. 7

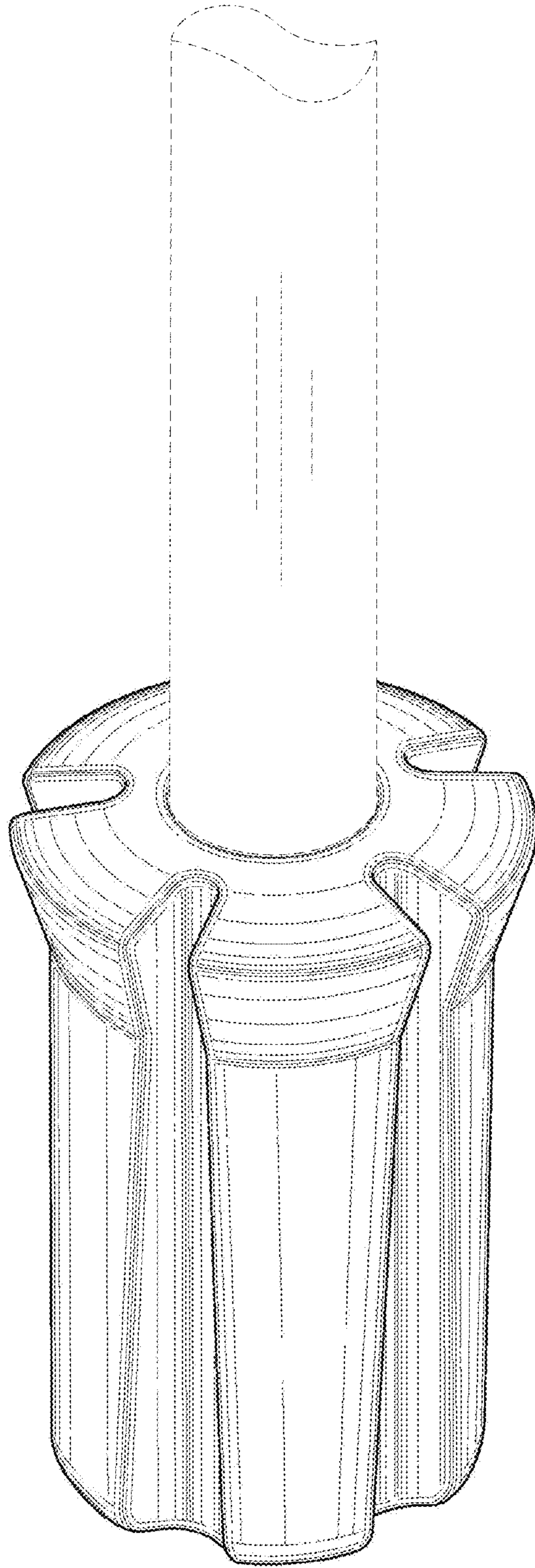

FIG. 8