



US00D828764S

(12) **United States Design Patent** (10) **Patent No.:** **US D828,764 S**  
**Totani** (45) **Date of Patent:** **\*\* Sep. 18, 2018**

(54) **SPOUTED POUCH**

- (71) Applicant: **TOTANI CORPORATION**,  
Kyoto-Shi, Kyoto (JP)
- (72) Inventor: **Mikio Totani**, Tokyo (JP)
- (73) Assignee: **TOTANI CORPORATION**, Kyoto-shi  
(JP)
- (\*\*) Term: **15 Years**
- (21) Appl. No.: **29/624,286**
- (22) Filed: **Oct. 31, 2017**

**Related U.S. Application Data**

- (62) Division of application No. 29/574,608, filed on Aug. 17, 2016, now Pat. No. Des. 808,820.

**Foreign Application Priority Data**

- (30)
- |               |      |             |
|---------------|------|-------------|
| Feb. 17, 2016 | (JP) | 2016-003325 |
| Feb. 17, 2016 | (JP) | 2016-003326 |
| Feb. 17, 2016 | (JP) | 2016-003327 |
| Feb. 17, 2016 | (JP) | 2016-003331 |
| Feb. 17, 2016 | (JP) | 2016-003333 |
| Feb. 17, 2016 | (JP) | 2016-003334 |
| Feb. 17, 2016 | (JP) | 2016-003335 |
- (Continued)

- (51) **LOC (11) Cl.** ..... **09-05**
- (52) **U.S. Cl.**  
USPC ..... **D9/707**
- (58) **Field of Classification Search**  
USPC ..... D9/702-714, 719, 738-740, 517-518,  
D9/522, 416, 435, 444, 460, 455, 414,  
(Continued)

(56) **References Cited**

**U.S. PATENT DOCUMENTS**

- |          |   |   |        |          |       |        |
|----------|---|---|--------|----------|-------|--------|
| D344,015 | S | * | 2/1994 | Jacobson | ..... | D3/227 |
| D344,016 | S | * | 2/1994 | Jacobson | ..... | D9/709 |
- (Continued)

**FOREIGN PATENT DOCUMENTS**

- |    |                |         |
|----|----------------|---------|
| EM | 001239750-0010 | 10/2010 |
| JP | D1064028 A     | 3/2000  |
- (Continued)

**OTHER PUBLICATIONS**

Packaging Digest, vol. 4, No. 41, p. 36 (no data) (Cited in parent U.S. Appl. No. 29/574,608, filed Aug. 17, 2016).  
(Continued)

*Primary Examiner* — Abraham Bahta  
(74) *Attorney, Agent, or Firm* — Westerman, Hattori,  
Daniels & Adrian, LLP

(57) **CLAIM**

The ornamental design for a spouted pouch, as shown and described.

**DESCRIPTION**

FIG. 1 is an isometric view of a spouted pouch showing my new design, showing the top, front, and right side thereof. FIG. 2 is a front elevational view thereof. FIG. 3 is a rear elevational view thereof. FIG. 4 is a right side elevational view thereof. FIG. 5 is a left side elevational view thereof. FIG. 6 is a top plan view thereof. FIG. 7 is a bottom plan view thereof; and, FIG. 8 is an isometric view thereof, showing the spouted pouch in use in an expanded condition. The broken line portions of the design are included to show unclaimed portions and form no part of the claim.

**1 Claim, 4 Drawing Sheets**

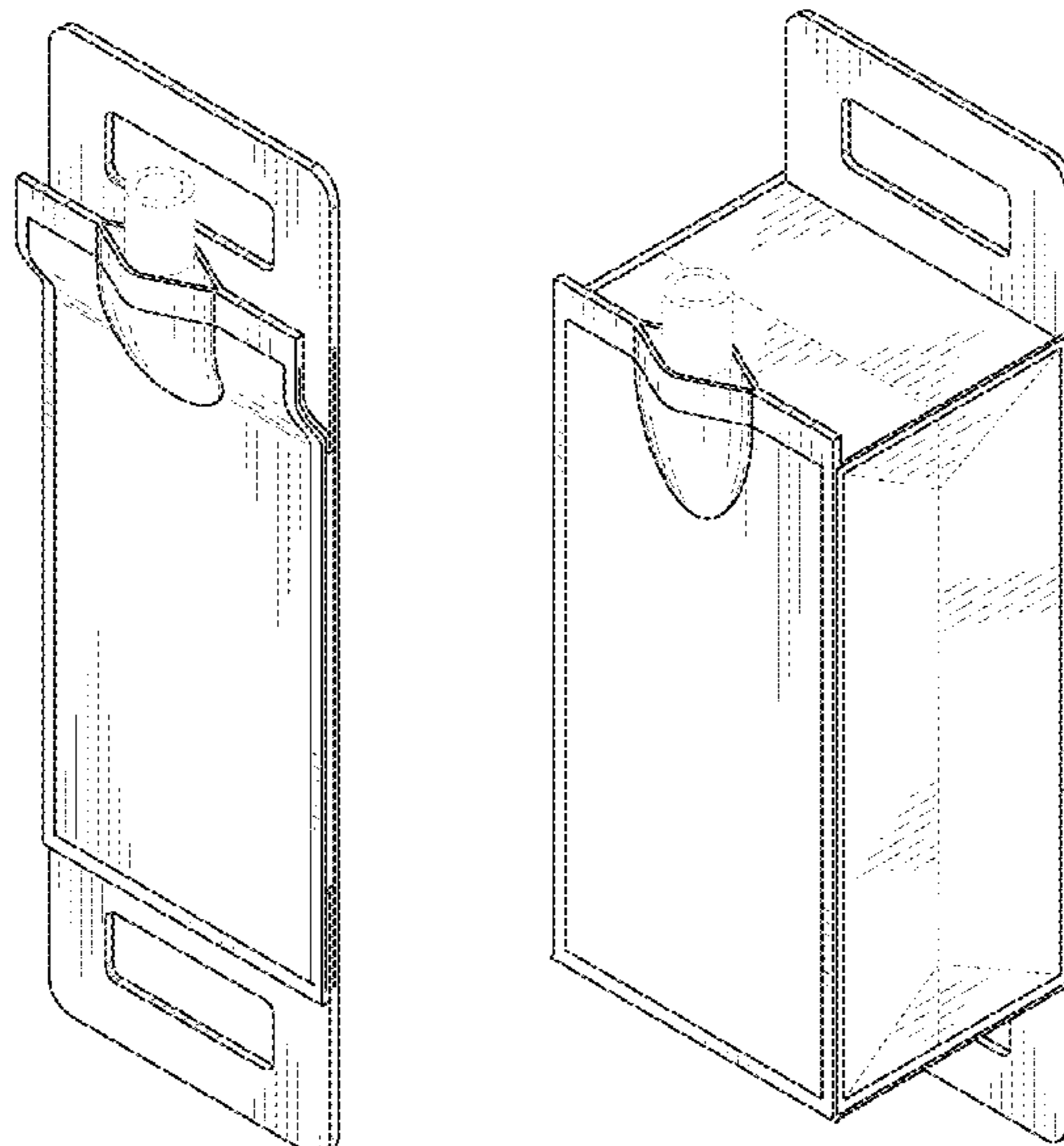

**(30) Foreign Application Priority Data**

Feb. 17, 2016 (JP) ..... 2016-003336  
 Feb. 17, 2016 (JP) ..... 2016-003340

**(58) Field of Classification Search**

USPC ..... D9/499, 431-432; D7/560-562;  
 206/434, 426-427, 429-430, 485, 485.1,  
 206/499, 508, 431, 418-422, 588-594,  
 206/286, 299; 229/117.3, 185, 121, 122,  
 229/200, 207, 236, 87.01, 923, 922,  
 229/87.19, 87.18; 220/23.83;  
 383/118-120, 110, 108, 127, 83, 6, 26,  
 383/33, 78, 88; D3/303-307, 221, 226,  
 D3/232, 276, 315; 150/100, 107, 112,  
 150/118  
 CPC .... A45C 3/00; A45C 3/04; A45C 3/06; A45C  
 3/001; A45C 3/10; B65D 33/004; B65D  
 33/00; B65D 33/06; B65D 33/12; B65D  
 1/00; B65D 1/38; B65D 1/40; B65D  
 29/00; B65D 29/04; B65D 31/00; B65D  
 31/005; B65D 31/10; B65D 31/02; B65D  
 31/04; B65D 31/18; B65D 65/00; B65D  
 65/02; B65D 65/38; B65D 81/00; B65D  
 81/36

See application file for complete search history.

**(56) References Cited**

U.S. PATENT DOCUMENTS

D764,941 S \* 8/2016 Balganon Canela ..... D9/705  
 D786,697 S \* 5/2017 Dytchkowskyj ..... D9/708  
 D808,820 S \* 1/2018 Totani ..... D9/707  
 D814,941 S 4/2018 Conrardy

FOREIGN PATENT DOCUMENTS

JP	2000-153849 A	6/2000
JP	2009-208836 A	9/2009
JP	D1552632 S	6/2016
KR	1540 S	6/1997

OTHER PUBLICATIONS

Emballages, vol. 965, p. 147 (Nov. 2014) (Cited in parent U.S. Appl. No. 29/574,608, filed Aug. 17, 2016).  
 Notice of Allowance dated Apr. 26, 2018, issued in U.S. Appl. No. 29/624,277 (10 pages).  
 Notice of Allowance dated Apr. 26, 2018, issued in U.S. Appl. No. 29/624,282, (10 pages).  
 Notice of Allowance dated May 11, 2018, issued in U.S. Appl. No. 29/624,284. (14 pages).

\* cited by examiner

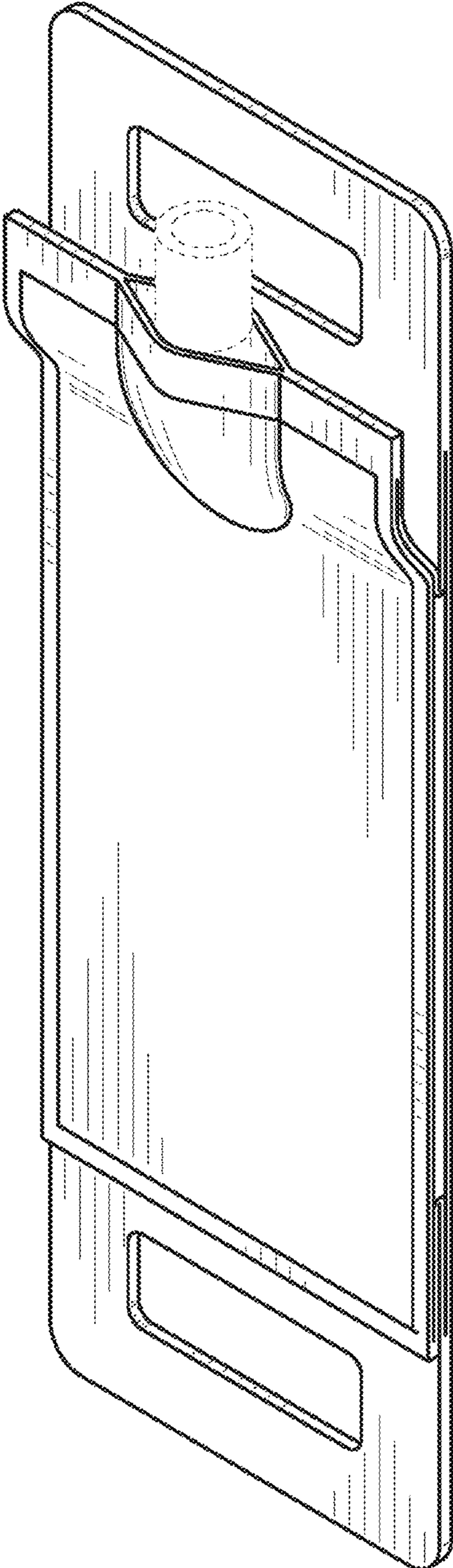

FIG. 1

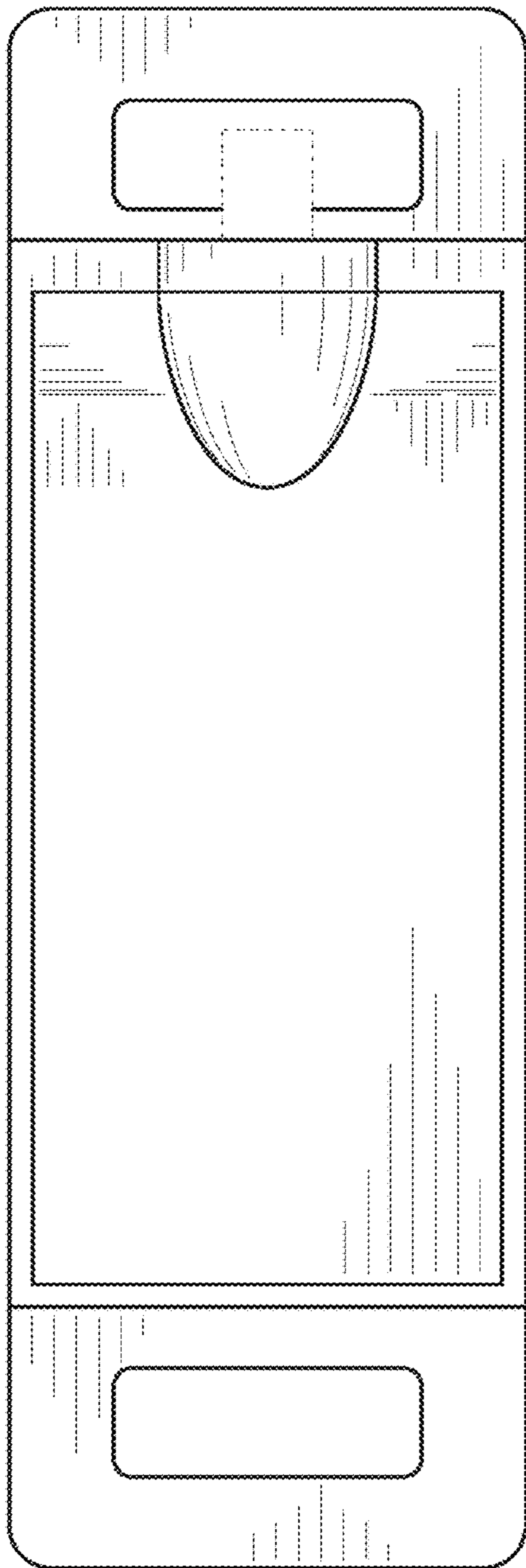

FIG. 2

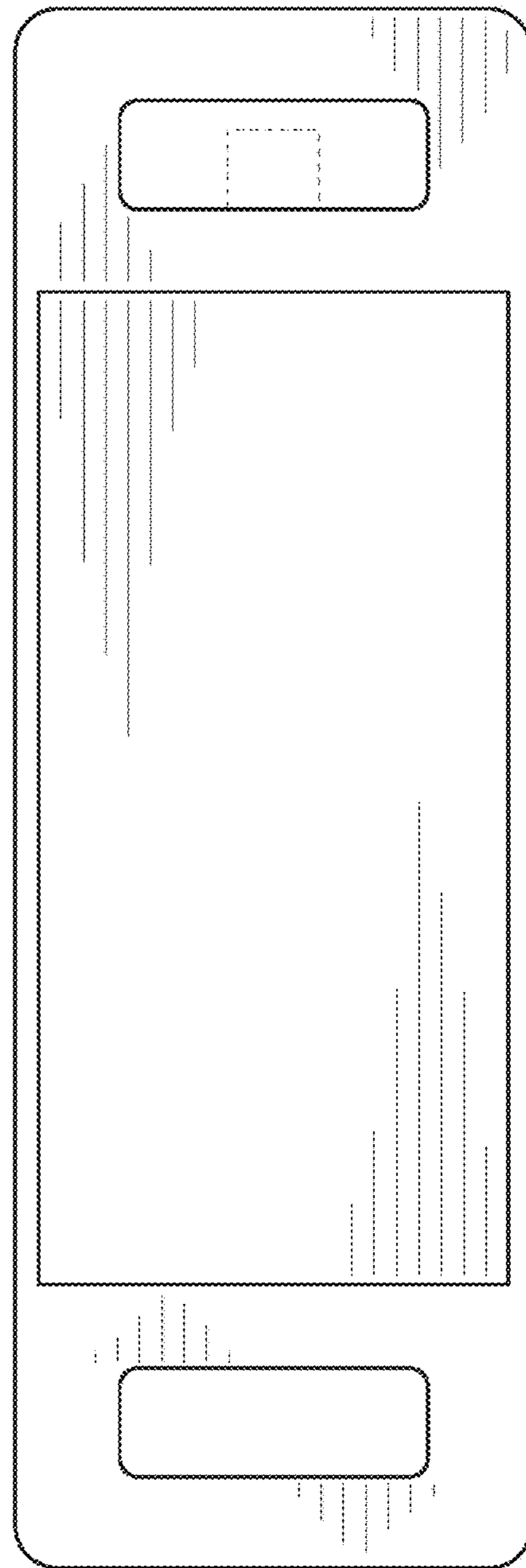

FIG. 3





FIG. 4

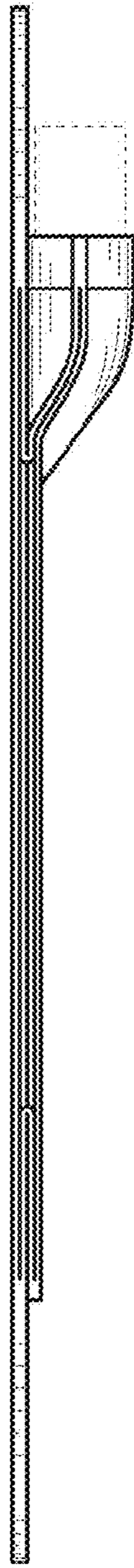

FIG. 5

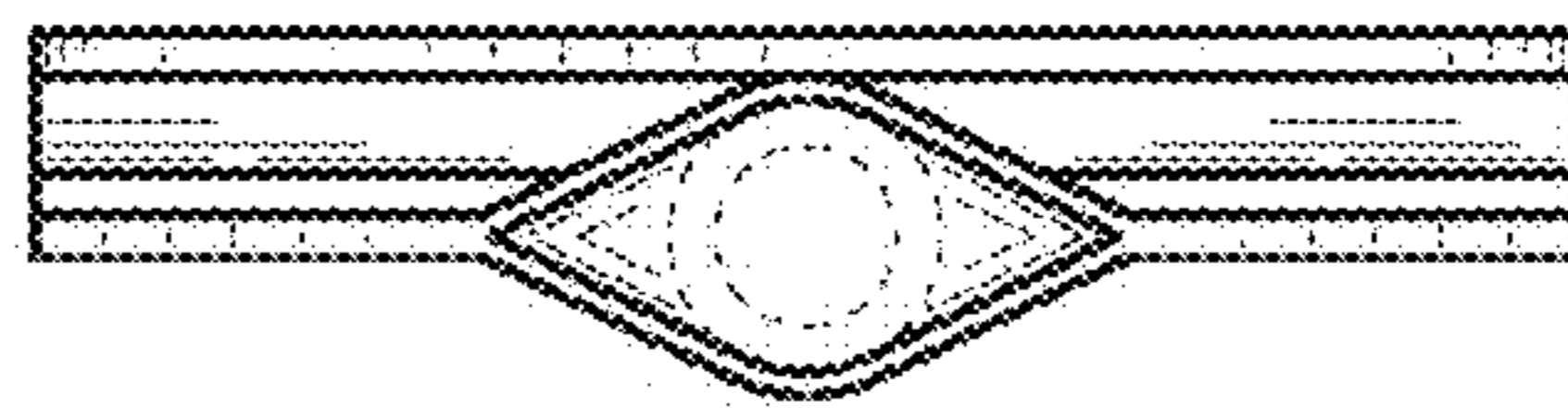

FIG. 6



FIG. 7

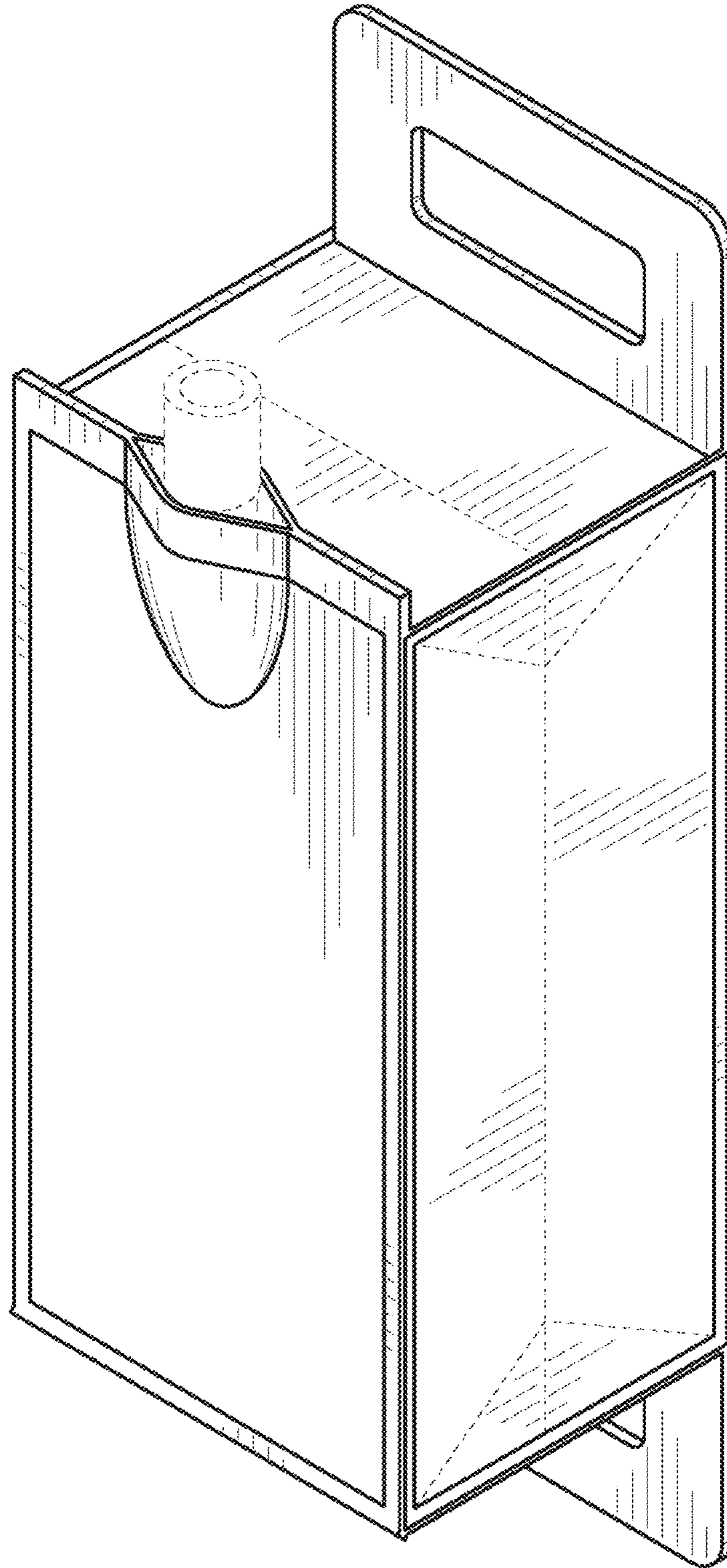

FIG. 8