



US00D828763S

(12) **United States Design Patent** (10) **Patent No.:** **US D828,763 S**
Tan (45) **Date of Patent:** **** Sep. 18, 2018**

(54) **SEALABLE PAPER BAG**

(71) Applicant: **Pan Pacific Plastics Mfg., Inc.**,
Hayward, CA (US)

(72) Inventor: **Hin Siang Michael Tan**, Danville, CA
(US)

(73) Assignee: **PAN PACIFIC PLASTICS MFG.,
INC.**, Hayward, CA (US)

(**) Term: **15 Years**

(21) Appl. No.: **29/603,884**

(22) Filed: **May 12, 2017**

(51) **LOC (11) Cl.** **09-01**

(52) **U.S. Cl.**
USPC **D9/705**

(58) **Field of Classification Search**

USPC D9/702-714, 719, 738-740, 517-518,
D9/522, 416, 435, 444, 460, 455, 414,
D9/499, 431-432; D7/560-562;
206/434, 426-427, 429-430, 485, 485.1,
206/499, 508, 431, 418-422, 588-594;
229/117.3, 185, 121, 122, 200, 207, 236,
229/87.01; 220/23.83; 150/100-118;
294/137, 152; 383/6, 10, 14, 20, 40, 33,
(Continued)

(56) **References Cited**

U.S. PATENT DOCUMENTS

D47,085 S * 3/1915 Veith 206/216
D225,311 S * 12/1972 Harrison D9/703
D239,253 S * 3/1976 Tiep D9/707
(Continued)

Primary Examiner — Abraham Bahta

(74) *Attorney, Agent, or Firm* — Beyer Law Group LLP

(57) **CLAIM**

I claim the ornamental design for a sealable paper bag,
substantially as shown and described.

DESCRIPTION

FIG. 1 is a top perspective view of a sealable paper bag in
accordance with the present design.

FIG. 2 is a top perspective view of the sealable paper bag of
FIG. 1, with the paper bag in a sealed condition therein.

FIG. 3 is a front view thereof.

FIG. 4 is a rear view thereof.

FIG. 5 is a right side view thereof, the left side view being
a mirror image thereof.

FIG. 6 is a top view thereof.

FIG. 7 is a bottom view thereof.

FIG. 8 is an interior view of a rear sheet-like panel, taken
along the plane of the line 8-8 in FIG. 6.

FIG. 9 is a top perspective view of an upper portion of the
sealable paper bag of FIG. 1 in accordance with the present
design.

FIG. 10 is a top perspective view of the upper portion of the
sealable paper bag of FIG. 9, with the paper bag in a sealed
condition therein.

FIG. 11 is a front view thereof.

FIG. 12 is a rear view thereof.

FIG. 13 is a right side view thereof, the left side view being
a mirror image thereof.

FIG. 14 is a top view thereof.

FIG. 15 is a bottom view thereof; and,

FIG. 16 is an interior view of a rear sheet-like panel, taken
along the plane of the line 16-16 in FIG. 14.

The broken lines in the Figures show portions of the sealable
paper bag which form no part of the claimed design.

The shade lines in the Figures show contours and not surface
ornamentation.

The break-away portions shown in FIGS. 9-12 and 14-16 are
included to show that the sealable paper bag has no specific
length.

1 Claim, 12 Drawing Sheets

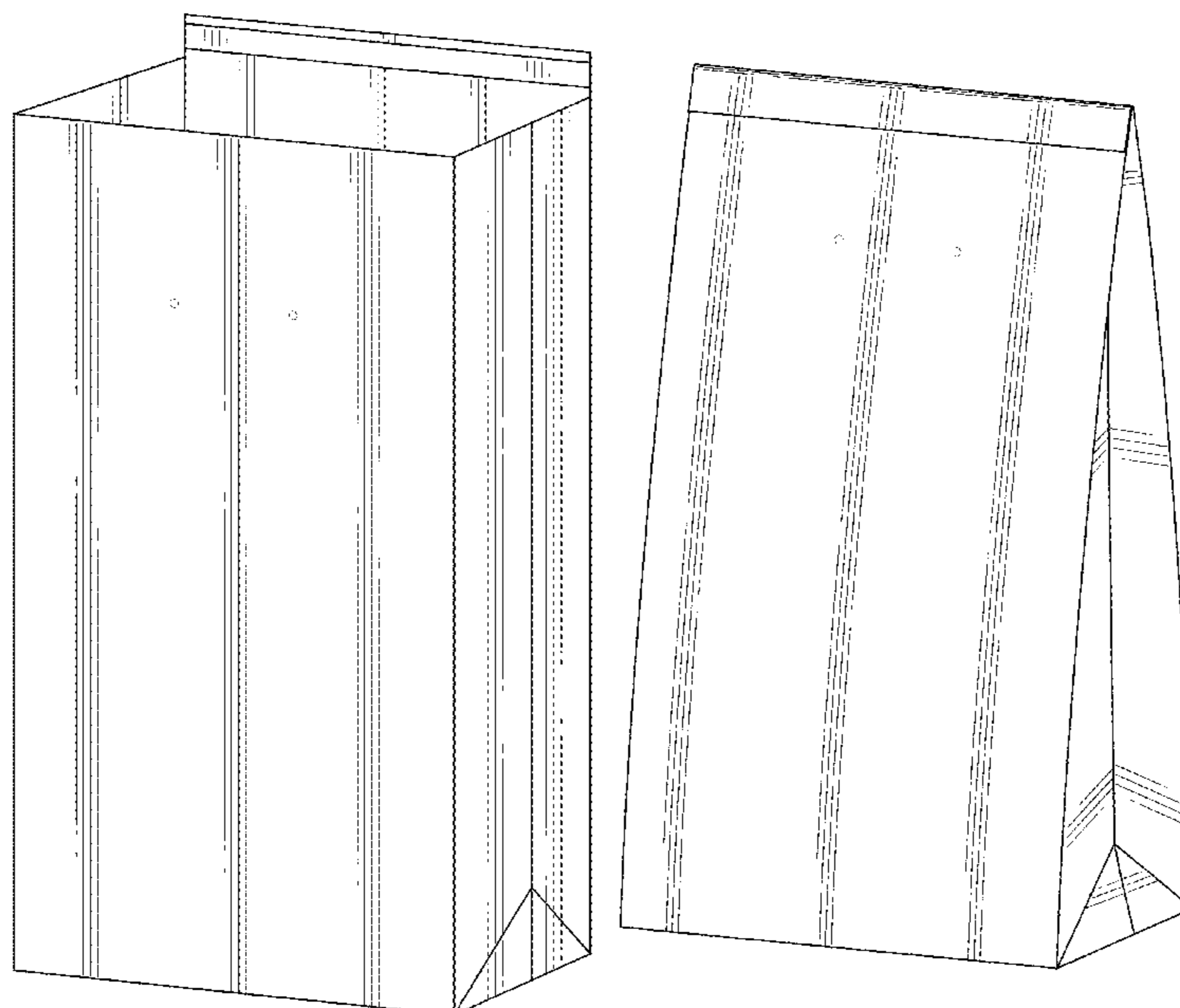

(58) **Field of Classification Search**

USPC 383/104–105, 117, 108, 120, 93, 121.1,
383/127; 428/34.3

CPC B65D 33/00; B65D 33/06; B65D 33/065;
B65D 33/14; B65D 33/1683; B65D
33/12; B65D 31/00; B65D 31/04; B65D
31/10; A45C 3/04; A45C 3/10

See application file for complete search history.

(56) **References Cited**

U.S. PATENT DOCUMENTS

D286,016	S	*	10/1986	Addiego	D9/517
D319,780	S	*	9/1991	Laaki	D9/707
D349,451	S	*	8/1994	Sagnard	D9/703
5,417,040	A	*	5/1995	Davoren	B65B 1/02 206/554
5,788,378	A	*	8/1998	Thomas	B65D 31/10 383/104
D501,134	S	*	1/2005	Takahashi	D9/703
D584,165	S	*	1/2009	Kerr	D9/705
D597,832	S	*	8/2009	Bischoff	D9/431
D801,826	S	*	11/2017	O'Connor	D9/649
2017/0001761	A1	*	1/2017	Arcot	B65D 33/007

* cited by examiner

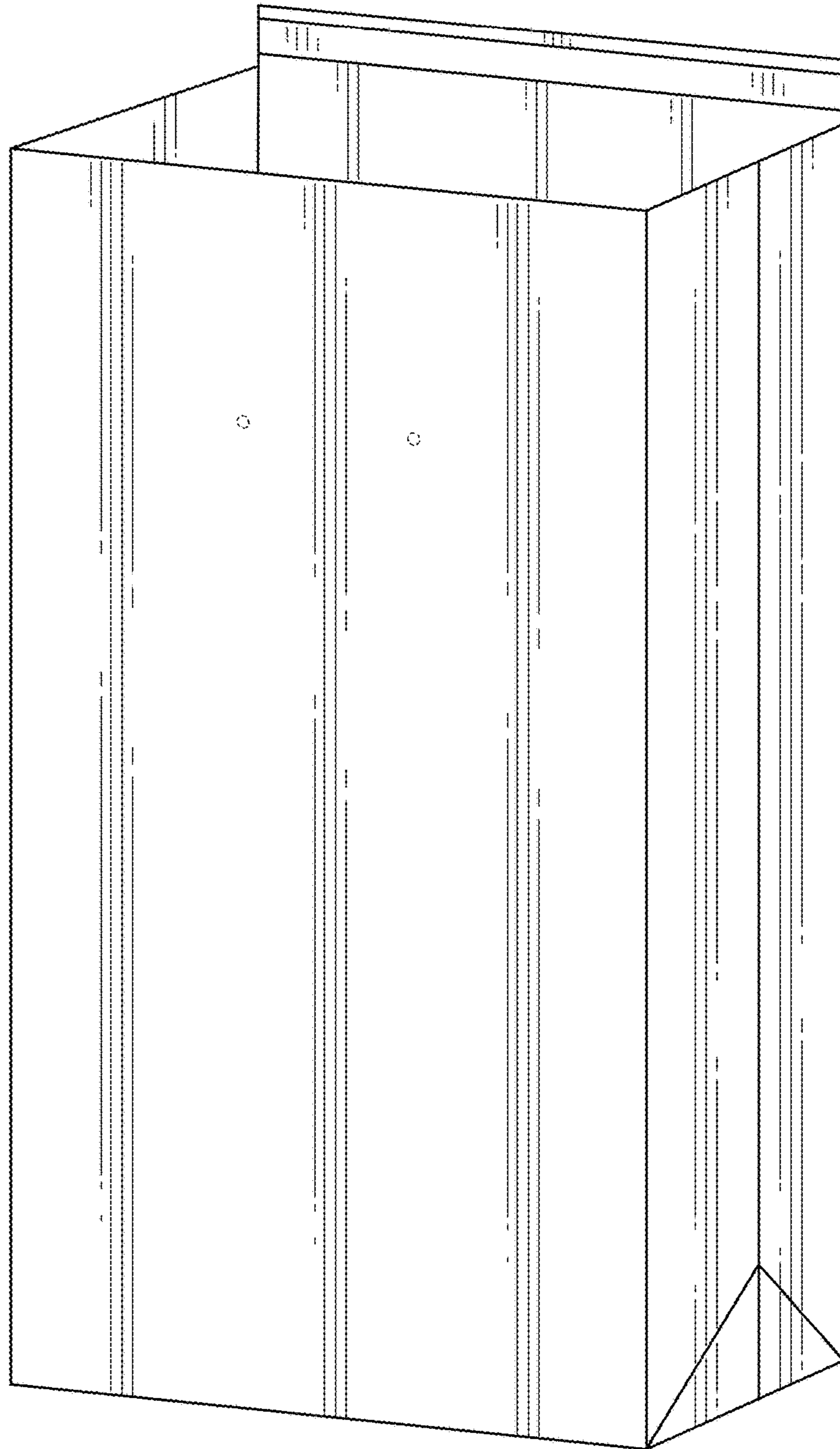

FIG. 1

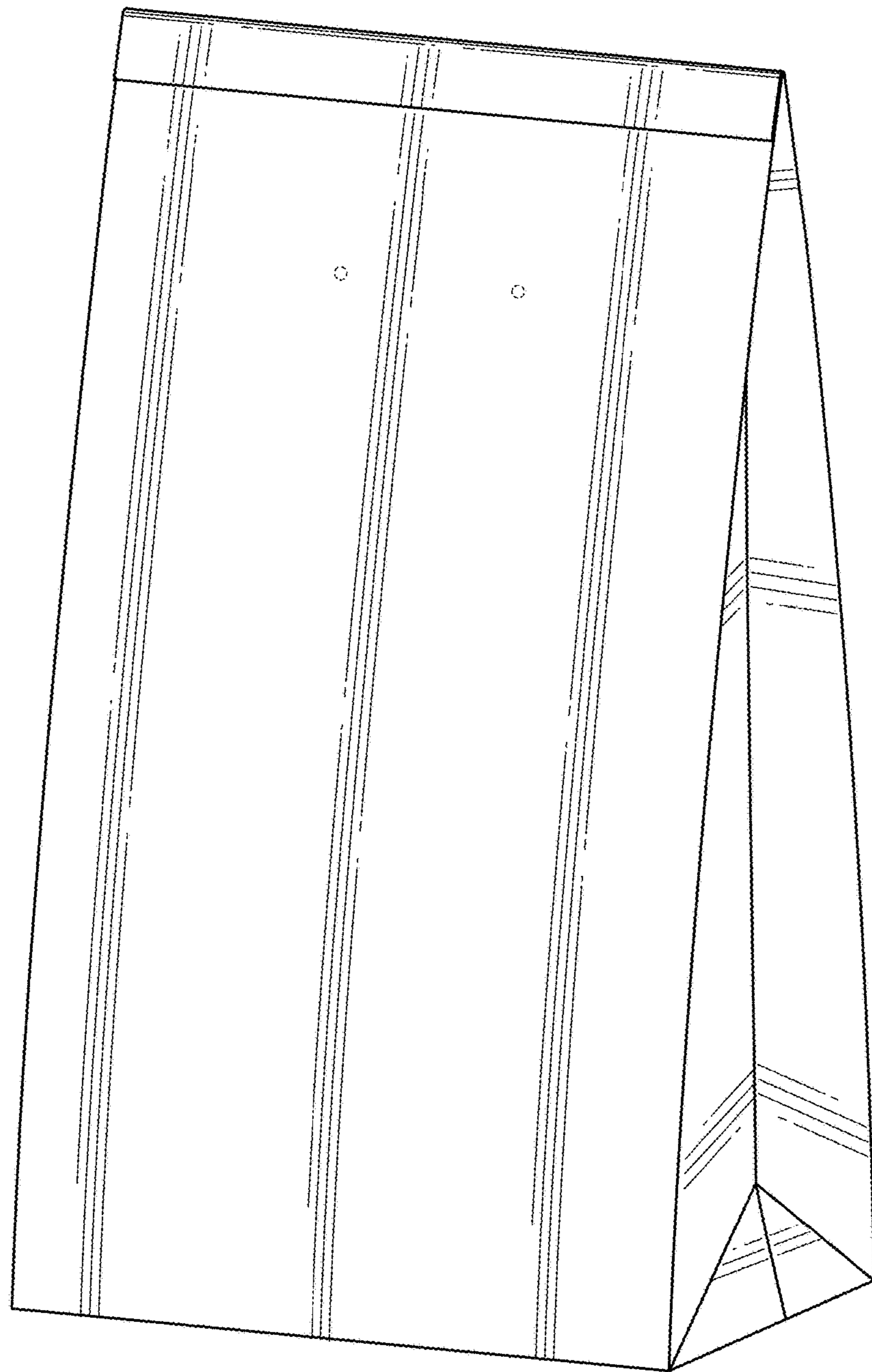

FIG. 2

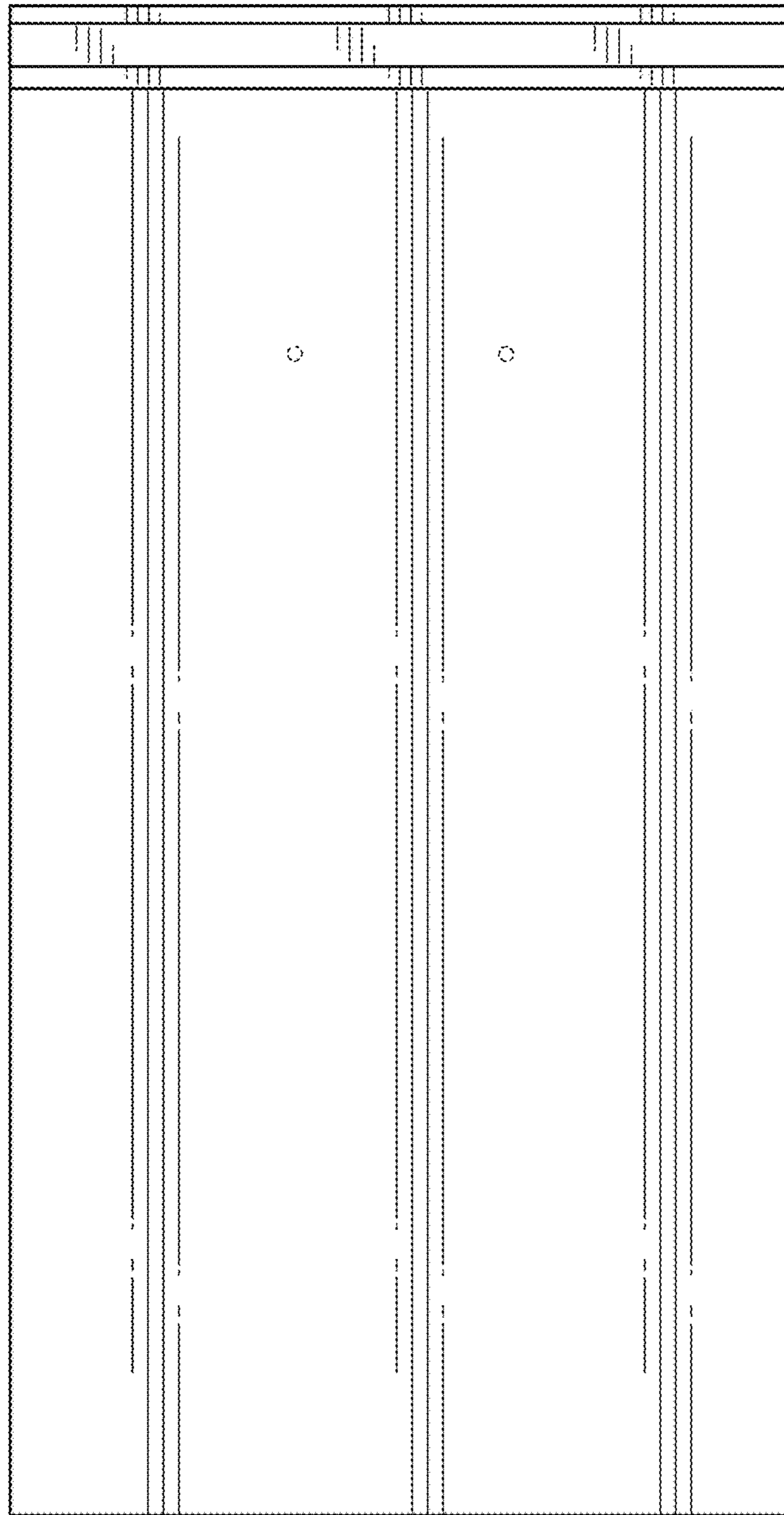

FIG. 3

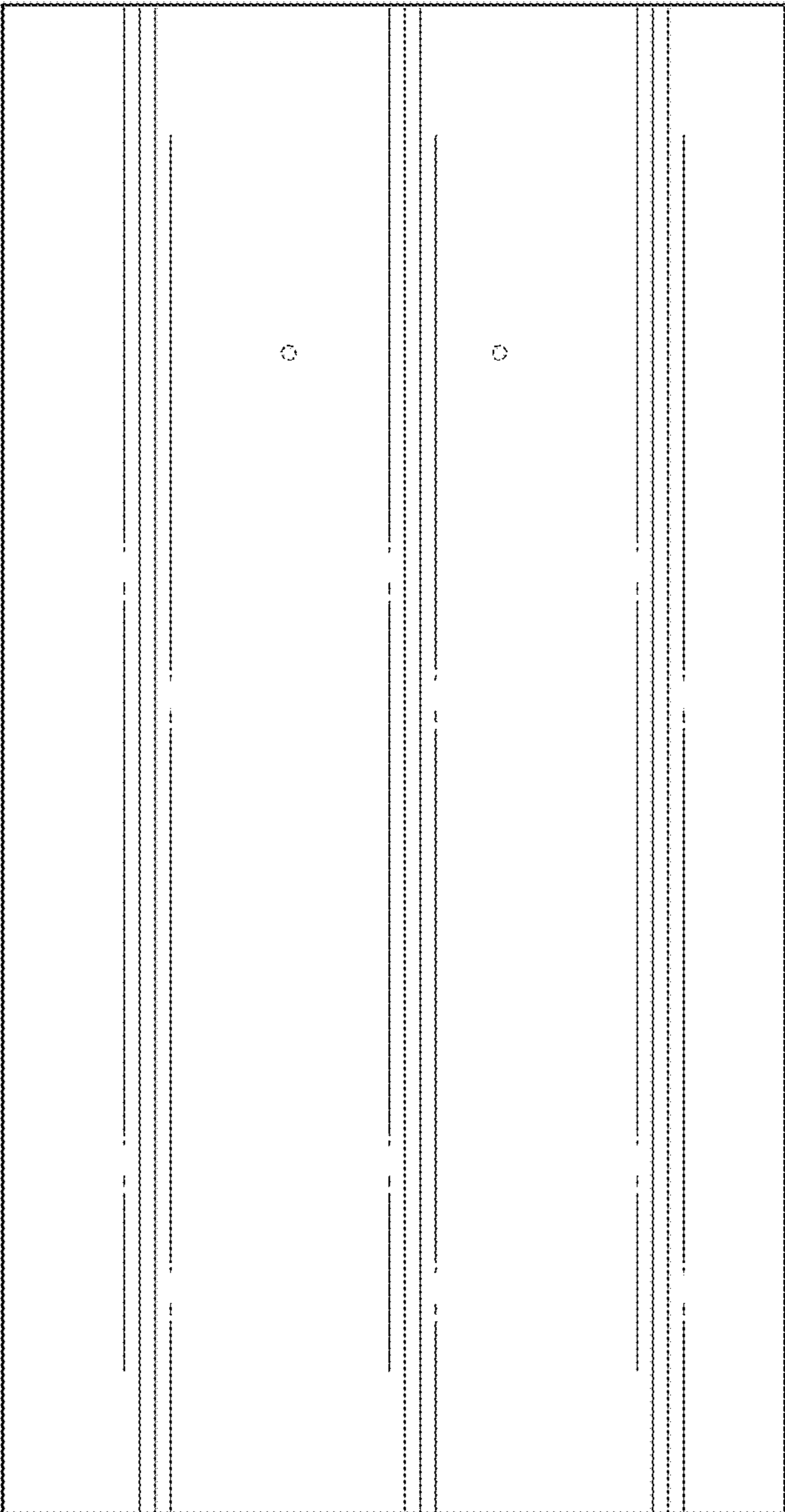

FIG. 4

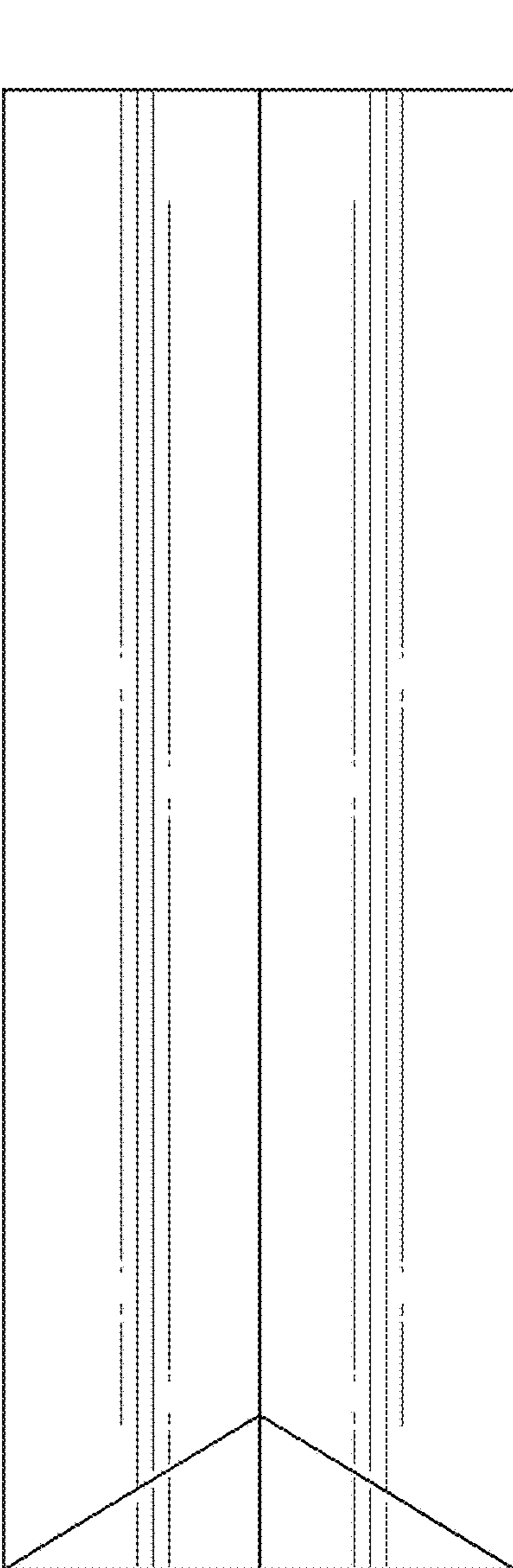

FIG. 5

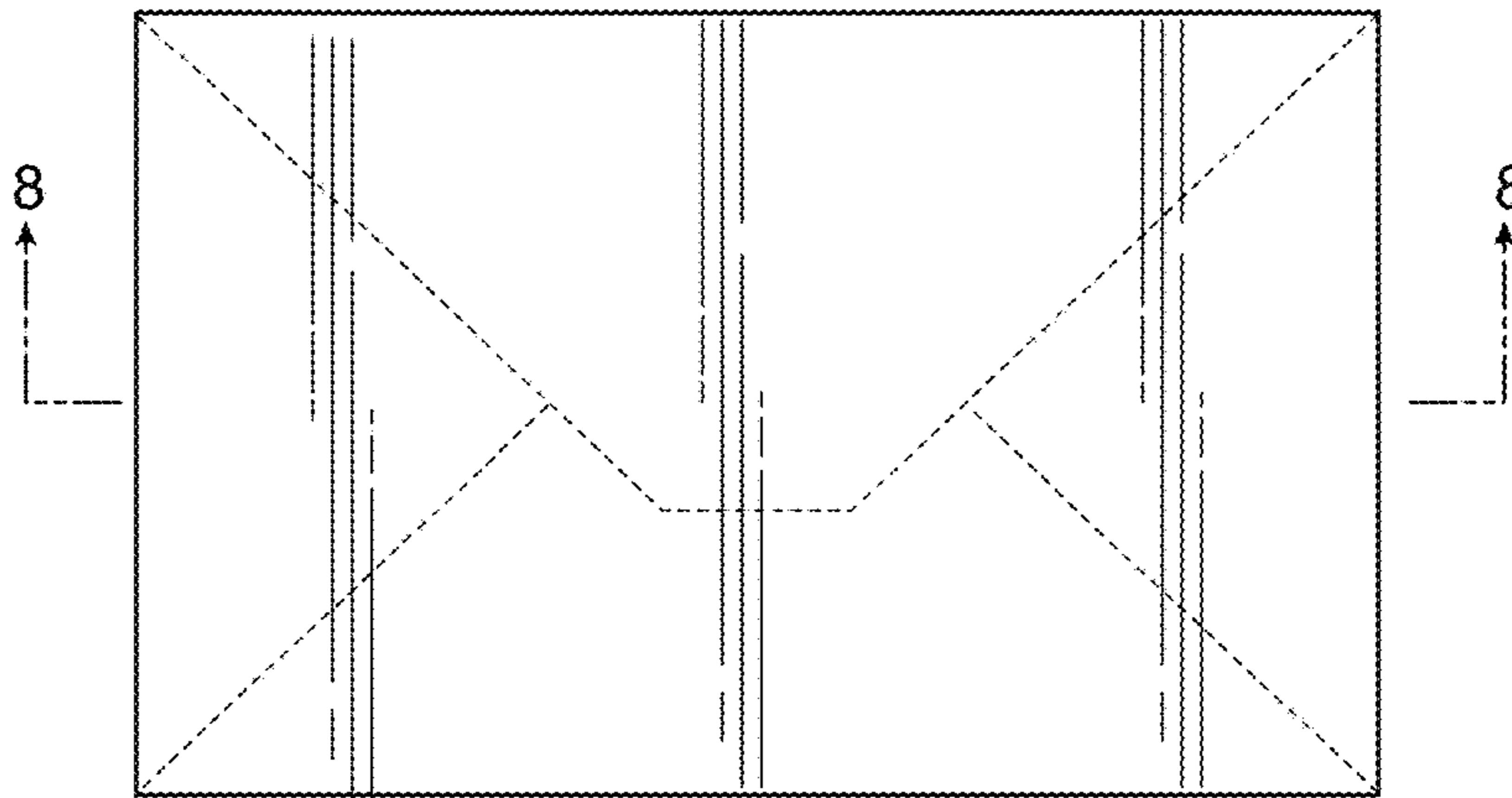

FIG. 6

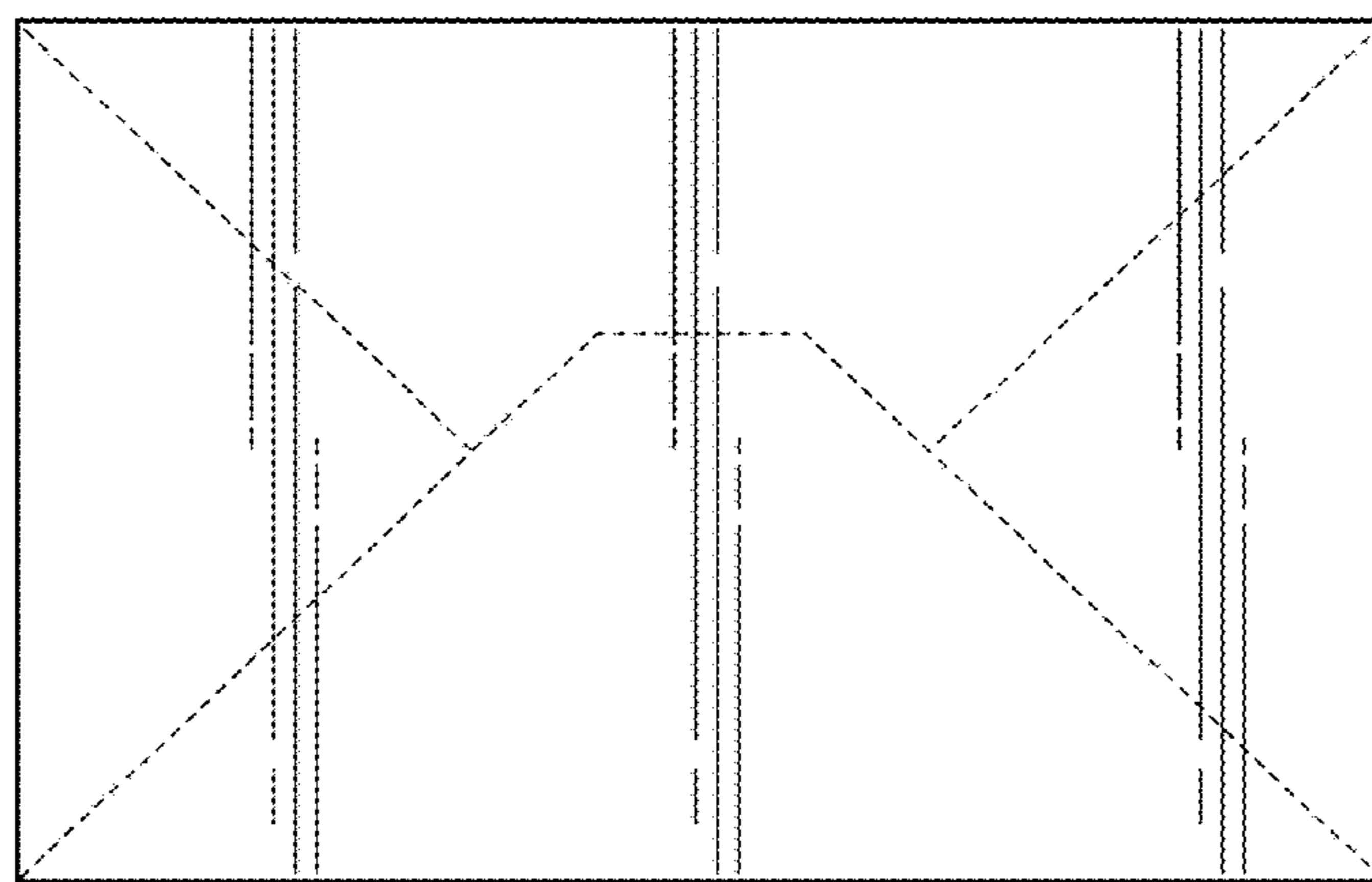

FIG. 7

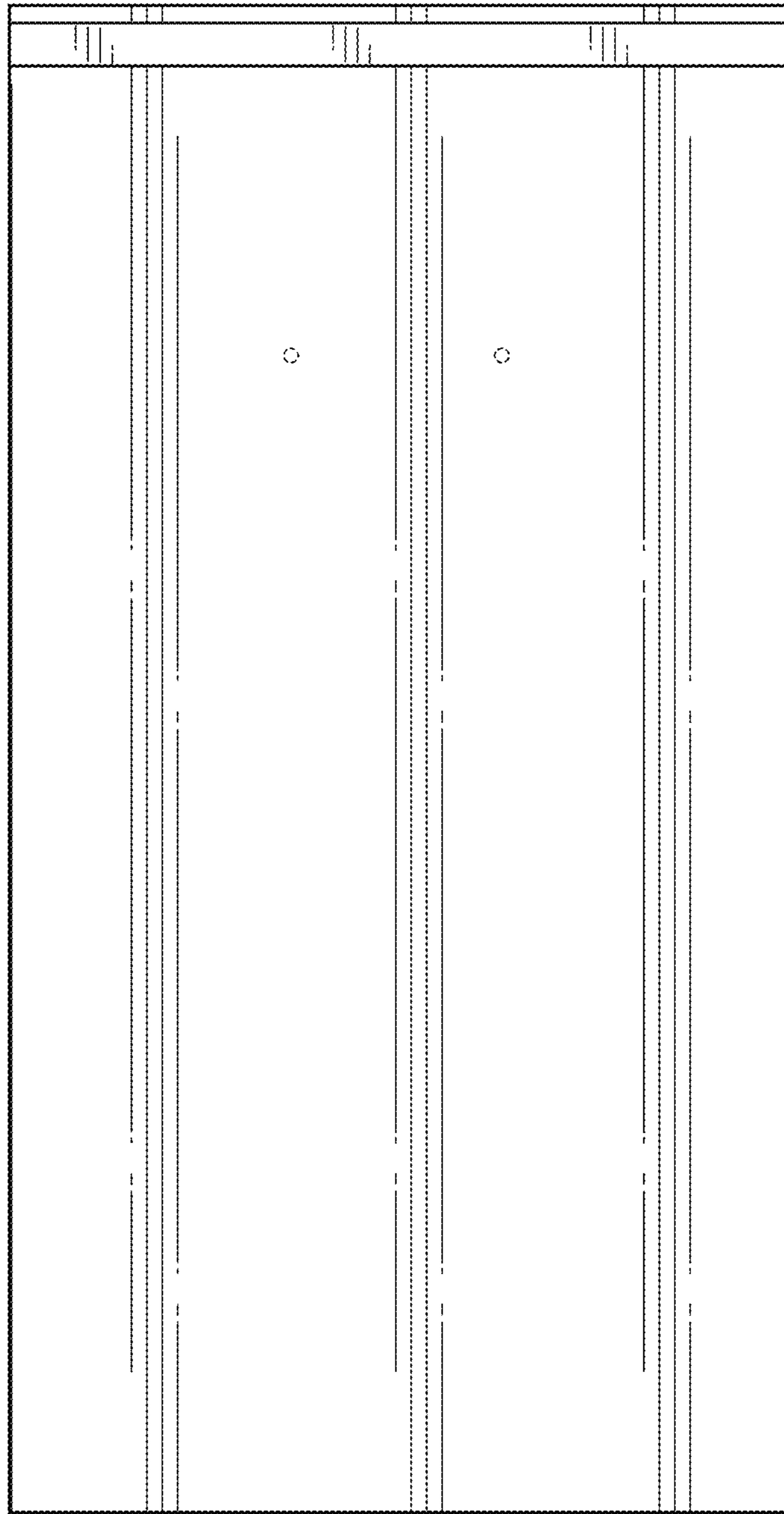

FIG. 8

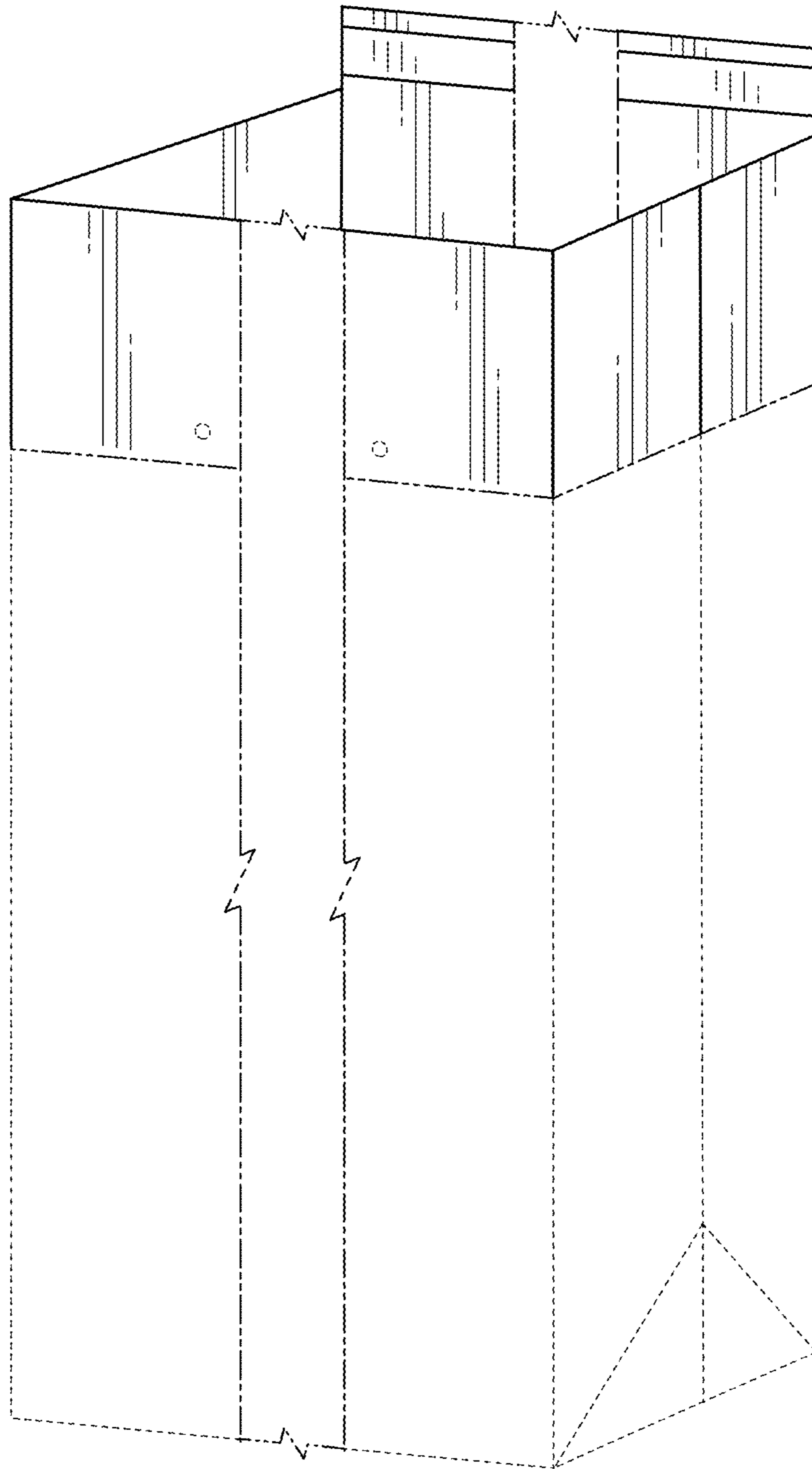

FIG. 9

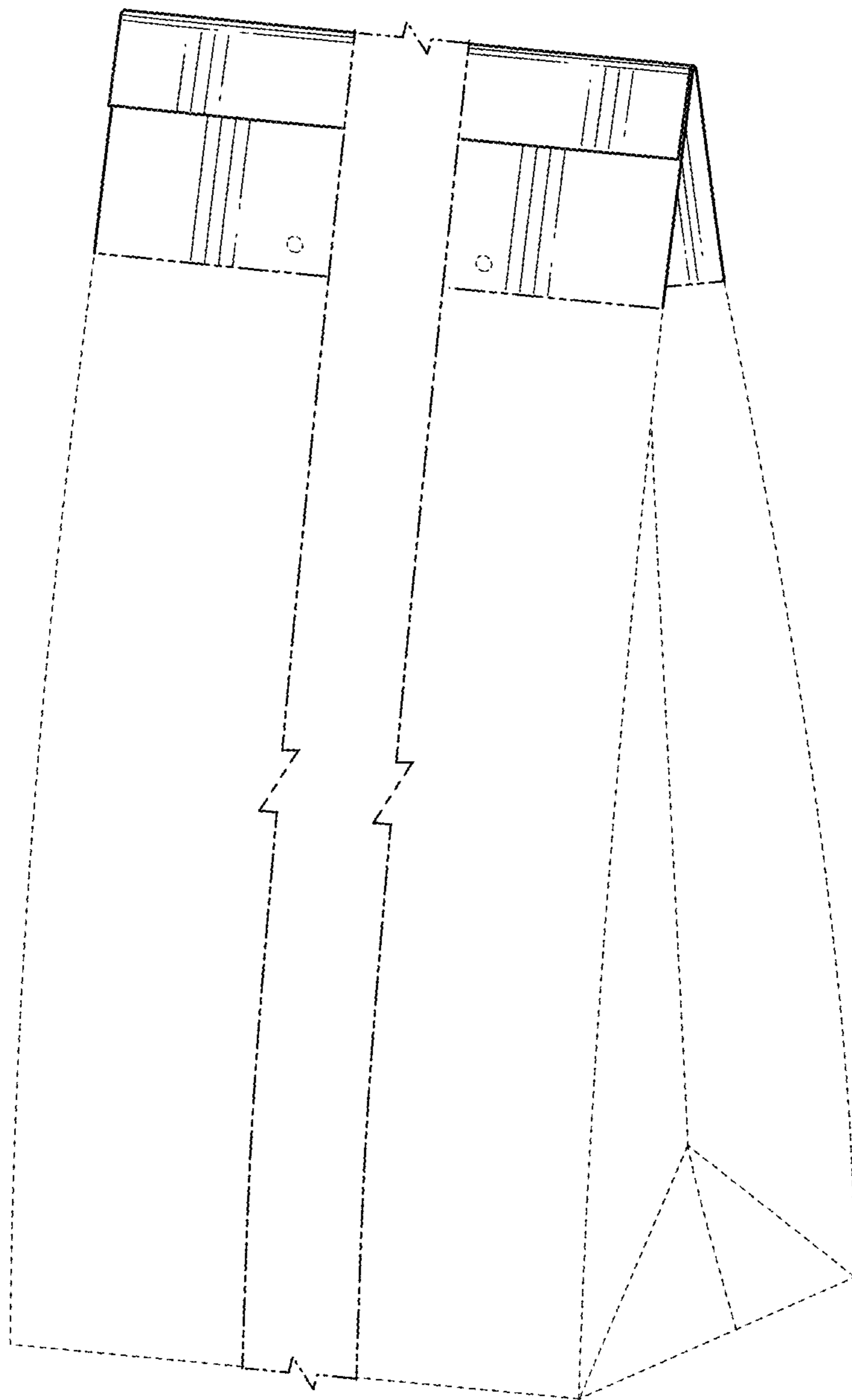

FIG. 10

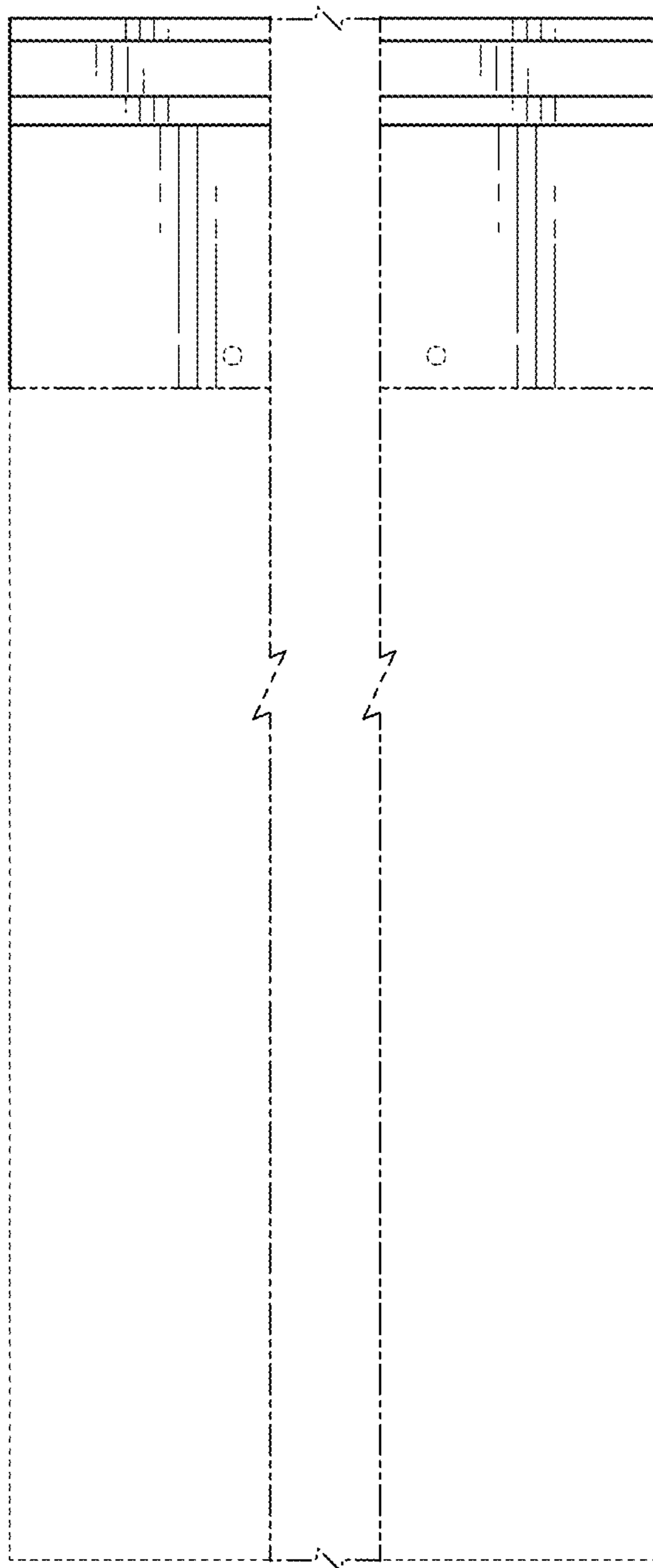

FIG. 11

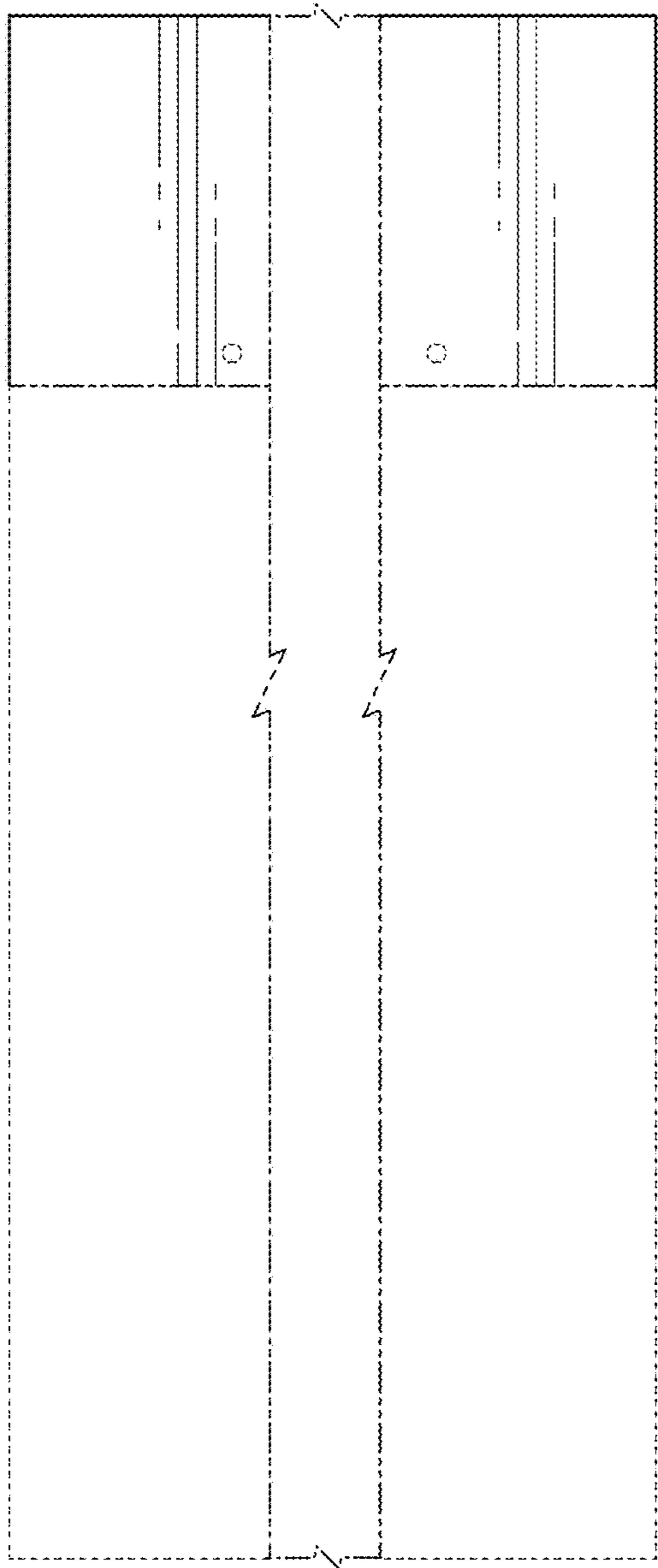

FIG. 12

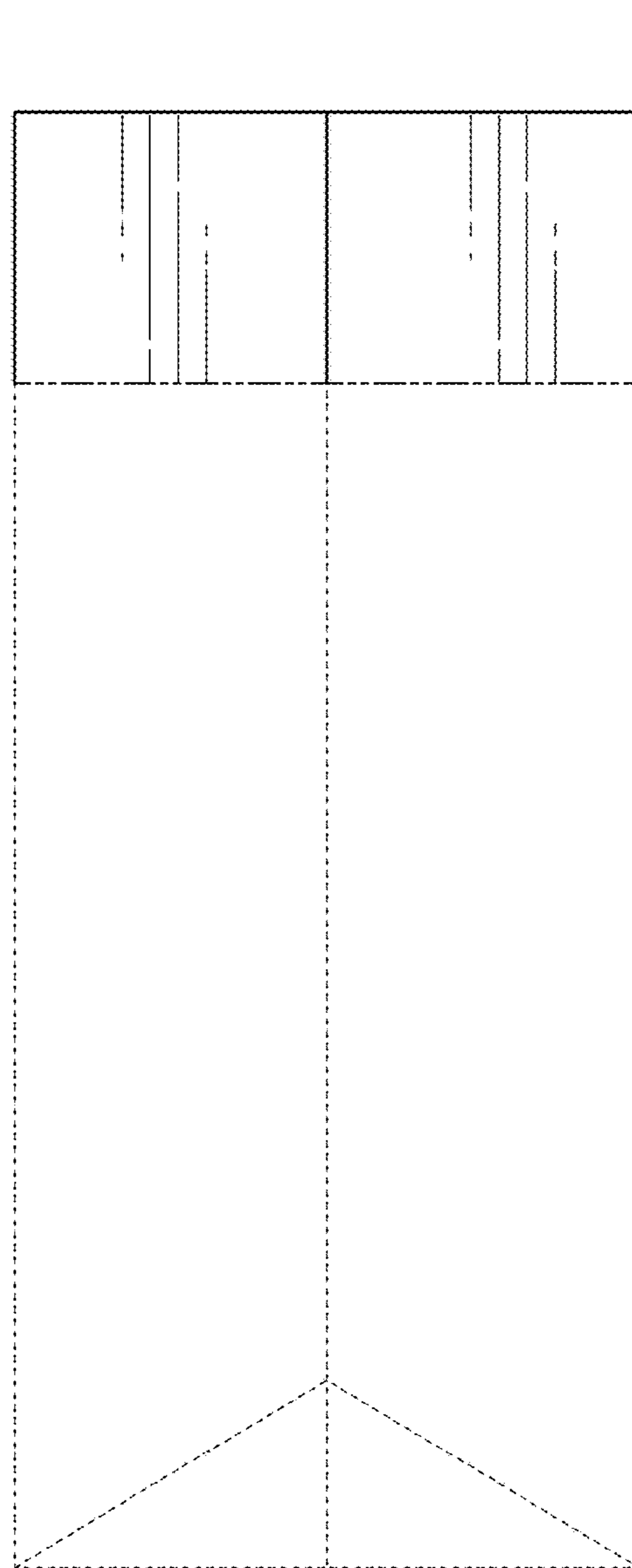

FIG. 13

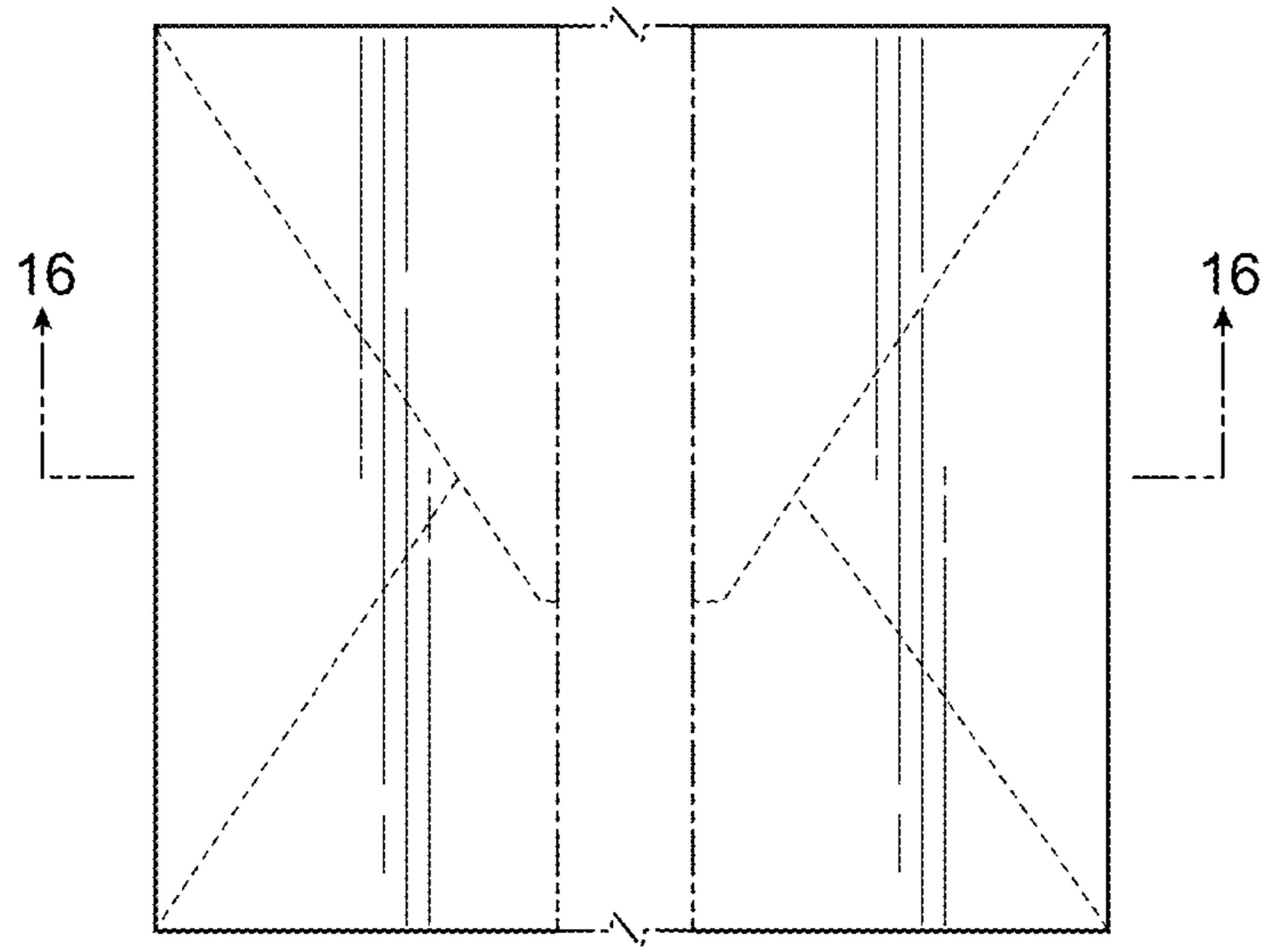

FIG. 14

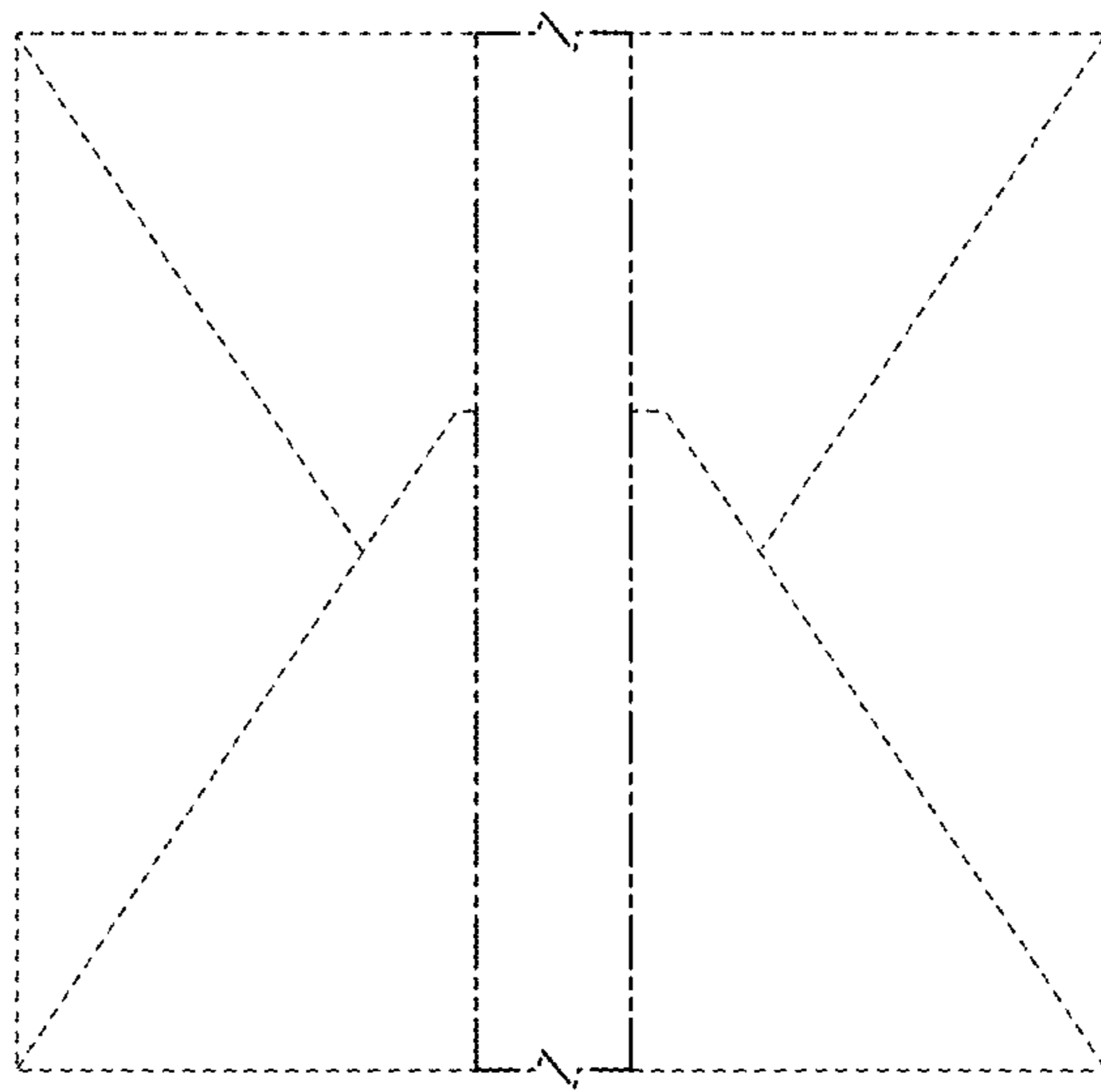

FIG. 15

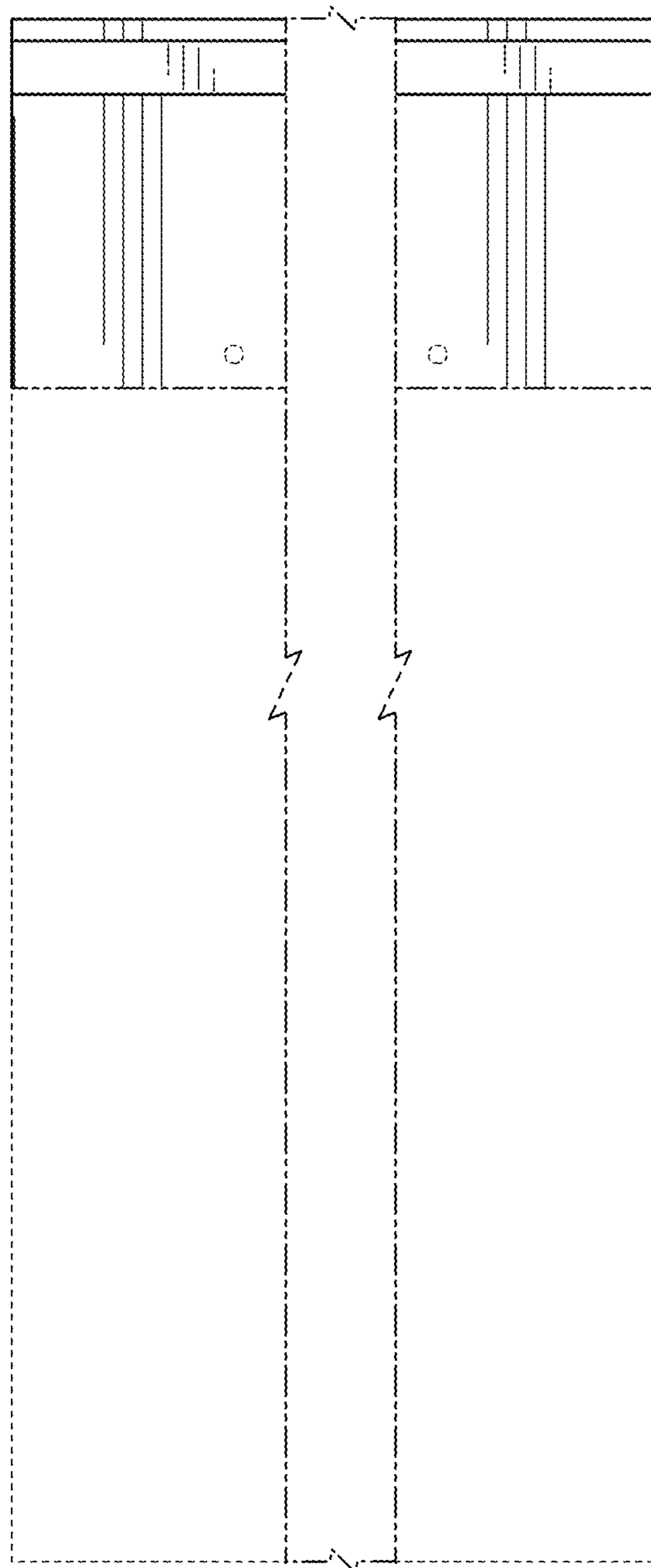

FIG. 16