



US00D828728S

(12) **United States Design Patent**  
**Jacobsen**

(10) **Patent No.:** **US D828,728 S**  
(45) **Date of Patent:** **\*\* Sep. 18, 2018**

(54) **BACKPACK COOLER**

(71) Applicant: **RTIC IP, LLC**, Houston, TX (US)

(72) Inventor: **James Matthew Jacobsen**, Houston, TX (US)

(73) Assignee: **RTIC IP, LLC**, Houston, TX (US)

(\*\*) Term: **15 Years**

(21) Appl. No.: **29/614,786**

(22) Filed: **Aug. 23, 2017**

(51) **LOC (11) Cl.** ..... **07-01**

(52) **U.S. Cl.**  
USPC ..... **D7/607**

(58) **Field of Classification Search**  
USPC ..... D7/605, 607, 709, 710, 629; D3/283,  
D3/287, 289, 318

(Continued)

(56) **References Cited**

**U.S. PATENT DOCUMENTS**

6,092,661 A \* 7/2000 Mogil ..... A63B 55/408  
150/106  
6,237,776 B1 \* 5/2001 Mogil ..... A45C 3/00  
150/106

(Continued)

**OTHER PUBLICATIONS**

'amazon.com' [online]. "California Pak Calpak Night Vision 18-Inch Rubber Bottom Laptop Rolling." Published on or before Aug. 22, 2017, Retrieved from the Internet: URL<<https://www.amazon.com/California-Pak-18-Inch-Rolling-Backpack/dp/B013FXT298/>>. 6 pages.

(Continued)

*Primary Examiner* — Freda S Nunn

(74) *Attorney, Agent, or Firm* — Fish & Richardson P.C.

(57) **CLAIM**

The ornamental design for a backpack cooler, substantially as shown and described.

**DESCRIPTION**

FIG. 1 is a perspective view of the backpack cooler in a closed position.

FIG. 2 is a front view of the backpack cooler in a closed position.

FIG. 3 is a rear view of the backpack cooler in a closed position.

FIG. 4 is a right side view of the backpack cooler in a closed position.

FIG. 5 is a left side view of the backpack cooler in a closed position.

FIG. 6 is a bottom view of the backpack cooler in a closed position.

FIG. 7 is a top view of the backpack cooler in a closed position.

FIG. 8 is a perspective view of my design for a backpack cooler with the top in an open position.

FIG. 9 is a front view of the backpack cooler in an open position.

FIG. 10 is a rear view of the backpack cooler in an opened position.

FIG. 11 is a right side view of the backpack cooler in an open position.

FIG. 12 is a left side view of the backpack cooler in an open position.

FIG. 13 is a bottom view of the backpack cooler in an open position; and,

FIG. 14 is a top view of the backpack cooler in an open position.

The inside of the cooler is unclaimed. The surface shading and contour lines in the drawings represent the contours and do not illustrate material, surface ornamentation, or surface decoration. The broken lines shown throughout represent a logo, a closure element, shoulder straps, hip straps and back cushioning elements and form no part of the claimed design. The dashed broken lines in the drawings are for environmental structure and form no part of the claimed design. The inside of the body portion of the backpack cooler is not claimed as part of the design.

**1 Claim, 6 Drawing Sheets**

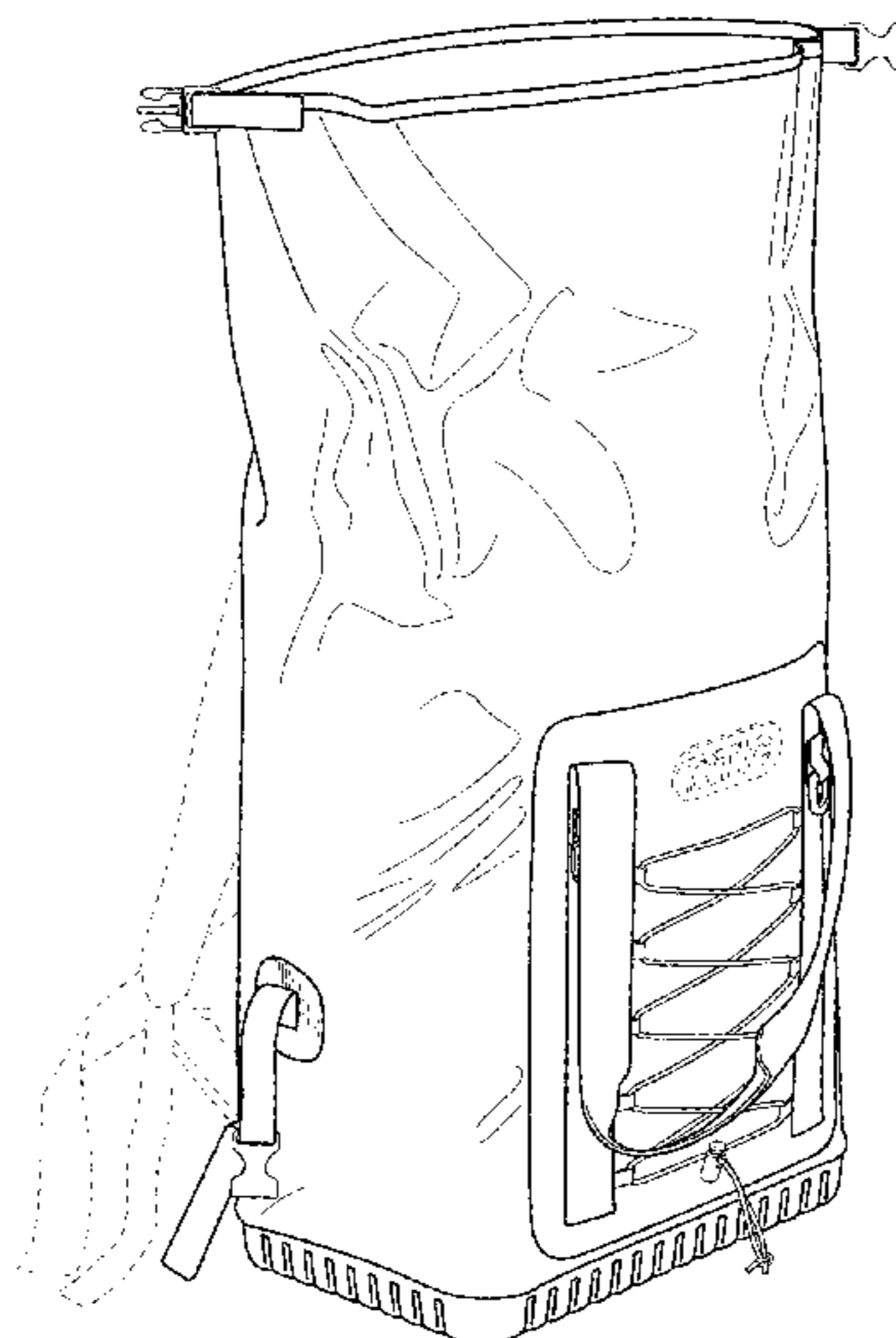
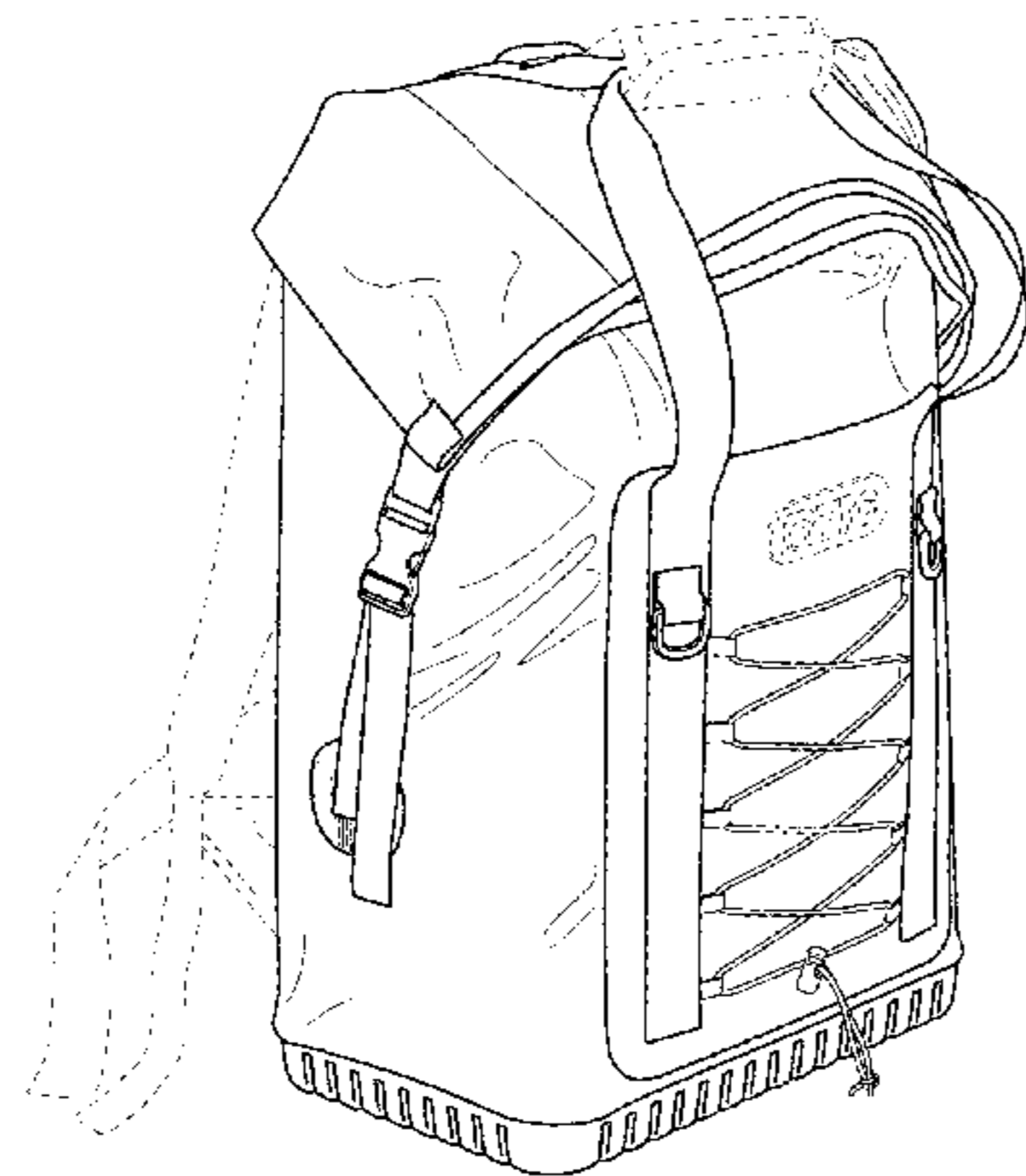

(58) **Field of Classification Search**

CPC ..... F25D 2331/804; F25D 3/08; B65D 30/08; B65D 30/22; B65D 81/3858; B65D 81/3823; B65D 81/3888; B65D 81/18; B65D 31/04; B65D 53/00; B65D 69/00; B65D 8/18; A45C 11/20; A45C 13/02; A45F 3/02; A45F 3/12; A45F 3/14; A45F 4/02

See application file for complete search history.

(56) **References Cited**

U.S. PATENT DOCUMENTS

6,439,389	B1 *	8/2002	Mogil .....	A45C 3/00 206/217
6,513,661	B1 *	2/2003	Mogil .....	A45C 3/00 150/106
8,043,004	B2 *	10/2011	Mogil .....	A45C 5/02 206/541
D732,348	S	6/2015	Seiders et al.	
D732,349	S	6/2015	Seiders et al.	
D732,350	S	6/2015	Seiders et al.	
D732,899	S	6/2015	Seiders et al.	
D752,347	S	3/2016	Seiders et al.	
D764,873	S *	8/2016	Collie .....	D7/607
D786,559	S	5/2017	Seiders et al.	
D786,560	S	5/2017	Seiders et al.	
D786,561	S	5/2017	Seiders et al.	
D786,562	S	5/2017	Seiders et al.	
D787,187	S	5/2017	Seiders et al.	
D797,454	S	9/2017	Seiders et al.	
D797,455	S	9/2017	Seiders et al.	
D798,670	S	10/2017	Seiders et al.	
2009/0184143	A1 *	7/2009	Witt .....	A45C 7/0059 224/153
2012/0111912	A1 *	5/2012	Zheng .....	A45C 15/00 224/576
2016/0244239	A1 *	8/2016	Nash .....	A45F 3/04

OTHER PUBLICATIONS

'amazon.com' [online]. "Fatboy Fatpack Extreme Kayak and Canoe Floating Waterproof Dry Bag, Soft Cooler, Rugged Protective Backpack," Published on or before Aug. 22, 2017, Retrieved from the Internet: URL<[https://www.amazon.com/Fatboy-Floating-Waterproof-Protective-Backpack/dp/B01LX4NC2W/ref=sr\\_1\\_63?s=apparel&ie=UTF8&qid=1506960124&sr=1-63&nodeID=7141123011&psd=1&keywords=cooler+backpack](https://www.amazon.com/Fatboy-Floating-Waterproof-Protective-Backpack/dp/B01LX4NC2W/ref=sr_1_63?s=apparel&ie=UTF8&qid=1506960124&sr=1-63&nodeID=7141123011&psd=1&keywords=cooler+backpack)>. 6 pages.

'amazon.com' [online]. "IceMule Coolers Pro Coolers," Published on or before Aug. 22, 2017, Retrieved from the Internet: URL<[https://www.amazon.com/IceMule-Coolers-Grey-Large-20-Liter/dp/B00IYJ7NR2/ref=sr\\_1\\_41?ie=UTF8&qid=1506960369&sr=8-41&keywords=cooler+backpack](https://www.amazon.com/IceMule-Coolers-Grey-Large-20-Liter/dp/B00IYJ7NR2/ref=sr_1_41?ie=UTF8&qid=1506960369&sr=8-41&keywords=cooler+backpack)>. 5 pages.

'amazon.com' [online]. "Koshanra Insulated Backpack Cooler," Published on or before Aug. 22, 2017, Retrieved from the Internet: URL<<https://www.amazon.com/Koshanra-Insulated-Backpack-Cooler/>

dp/B01NAU67YE/ref=sr\_1\_54?s=apparel&ie=UTF8&qid=1506960124&sr=1-54&nodeID=7141123011&psd=1&keywords=cooler+backpack>. 5 pages.

'amazon.com' [online]. "Kysek Trekker Backpack Ice Chest, Grey, One Size," Published on or before Aug. 22, 2017, Retrieved from the Internet: URL<[https://www.amazon.com/Kysek-Trekker-Backpack-Chest-Grey/dp/B01N2HPDVW/ref=sr\\_1\\_55?s=apparel&ie=UTF8&qid=1506960124&sr=1-55&nodeID=7141123011&psd=1&keywords=cooler+backpack](https://www.amazon.com/Kysek-Trekker-Backpack-Chest-Grey/dp/B01N2HPDVW/ref=sr_1_55?s=apparel&ie=UTF8&qid=1506960124&sr=1-55&nodeID=7141123011&psd=1&keywords=cooler+backpack)>. 5 pages.

'amazon.com' [online]. "Large Insulated Soft Cooler Backpack 28-Can (Camo)" Published on or before Aug. 22, 2017, Retrieved from the Internet: URL<[https://www.amazon.com/Large-Insulated-Cooler-Backpack-28-Can/dp/B01ILFBSCE/ref=sr\\_1\\_83?s=apparel&ie=UTF8&qid=1506960124&sr=1-83&nodeID=7141123011&psd=1&keywords=cooler+backpack](https://www.amazon.com/Large-Insulated-Cooler-Backpack-28-Can/dp/B01ILFBSCE/ref=sr_1_83?s=apparel&ie=UTF8&qid=1506960124&sr=1-83&nodeID=7141123011&psd=1&keywords=cooler+backpack)>. 4 pages.

'amazon.com' [online]. "Nupla 67419 Black Label Rubber Bottom Back Pack, 1680 Dernier Ballistic Material," Published on or before Aug. 22, 2017, Retrieved from the Internet: URL<<https://www.amazon.com/Nupla-67419-Dernier-Ballistic-Material/dp/B00KRCU1SW>>. 6 pages.

'amazon.com' [online]. "Patagonia Black Hole Pack 32L Navy Blue w/Paintbrush Red," Published on or before Aug. 22, 2017, Retrieved from the Internet: URL<[https://www.amazon.com/Patagonia-Black-Hole-Pack-Paintbrush/dp/B073GXMDYG/ref=sr\\_1\\_1?s=apparel&ie=UTF8&qid=1506959887&sr=1-1&nodeID=7141123011&psd=1&keywords=Patagonia+Black+Hole%E2%84%A2+Backpack+32L](https://www.amazon.com/Patagonia-Black-Hole-Pack-Paintbrush/dp/B073GXMDYG/ref=sr_1_1?s=apparel&ie=UTF8&qid=1506959887&sr=1-1&nodeID=7141123011&psd=1&keywords=Patagonia+Black+Hole%E2%84%A2+Backpack+32L)>. 5 pages.

'amazon.com' [online]. "Patagonia Lightweight Travel Tote Pack (Purple)" Published on or before Aug. 22, 2017, Retrieved from the Internet: URL<[https://www.amazon.com/Patagonia-Lightweight-Travel-Tote-1343cu/dp/B01MY8LXHM/ref=sr\\_1\\_1?ie=UTF8&qid=1506959764&sr=8-1&keywords=Patagonia%2BLightweight%2BTravel%2BTote%2BPack%2B22L&th=1](https://www.amazon.com/Patagonia-Lightweight-Travel-Tote-1343cu/dp/B01MY8LXHM/ref=sr_1_1?ie=UTF8&qid=1506959764&sr=8-1&keywords=Patagonia%2BLightweight%2BTravel%2BTote%2BPack%2B22L&th=1)>. 6 pages.

'amazon.com' [online]. "Timbuk2 Rogue Laptop Backpack," Published on or before Aug. 22, 2017, Retrieved from the Internet: URL<[https://www.amazon.com/dp/B00HSHKXMI/ref=as\\_li\\_ss\\_tl?ie=UTF8&linkCode=sll&tag=mattheavy-20&linkId=5e0f6e35df08d2b40b2ffae367380de4](https://www.amazon.com/dp/B00HSHKXMI/ref=as_li_ss_tl?ie=UTF8&linkCode=sll&tag=mattheavy-20&linkId=5e0f6e35df08d2b40b2ffae367380de4)>. 9 pages.

'amazon.com' [online]. "Waterproof 2-in-1 Dry Bag Leak Proof Cooler Backpack," Published on or before Aug. 22, 2017, Retrieved from the Internet: URL<[https://www.amazon.com/Waterproof-Leak-Proof-Cooler-Backpack/dp/B071LKS265/ref=sr\\_1\\_64?s=apparel&ie=UTF8&qid=1506960124&sr=1-64&nodeID=7141123011&psd=1&keywords=cooler+backpack](https://www.amazon.com/Waterproof-Leak-Proof-Cooler-Backpack/dp/B071LKS265/ref=sr_1_64?s=apparel&ie=UTF8&qid=1506960124&sr=1-64&nodeID=7141123011&psd=1&keywords=cooler+backpack)>. 4 pages.

'anypromo.com' [online]. "iCOOL™ Extreme Waterproof Cooler Backpack," Published on or before Aug. 22, 2017, Retrieved from the Internet: URL<[https://www.anypromo.com/bags-luggage/lunch-bags-cooler/icool-extreme-waterproof-cooler-backpack-p745858?utm\\_source=PLA&utm\\_medium=PC&utm\\_campaign=745858&s=1&glppc=1&gclid=EALalQobChMlmvCmzJXB1gIVAYy9Ch0opwYyEAKYCCABEGKpQvD\\_BwE](https://www.anypromo.com/bags-luggage/lunch-bags-cooler/icool-extreme-waterproof-cooler-backpack-p745858?utm_source=PLA&utm_medium=PC&utm_campaign=745858&s=1&glppc=1&gclid=EALalQobChMlmvCmzJXB1gIVAYy9Ch0opwYyEAKYCCABEGKpQvD_BwE)>. 3 pages.

'timberland.com' [online]. "Crofton 24-Liter Waterproof Backpack," Published on or before Aug. 22, 2017, Retrieved from the Internet: URL<<https://www.timberland.com/shop/crofton-24-liter-waterproof-backpack-black-a1ci4001>>. 2 pages.

\* cited by examiner

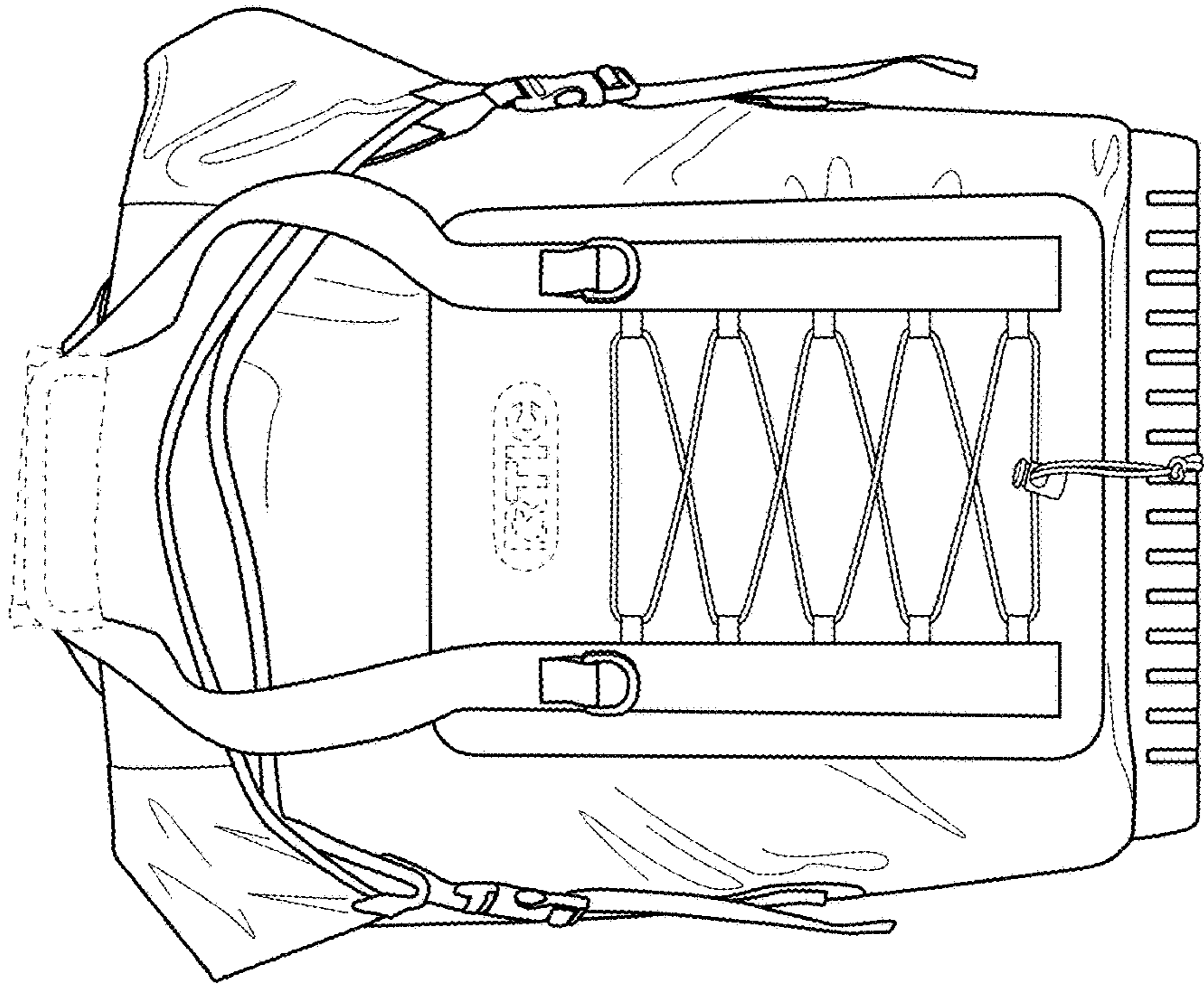

*Fig. 2*

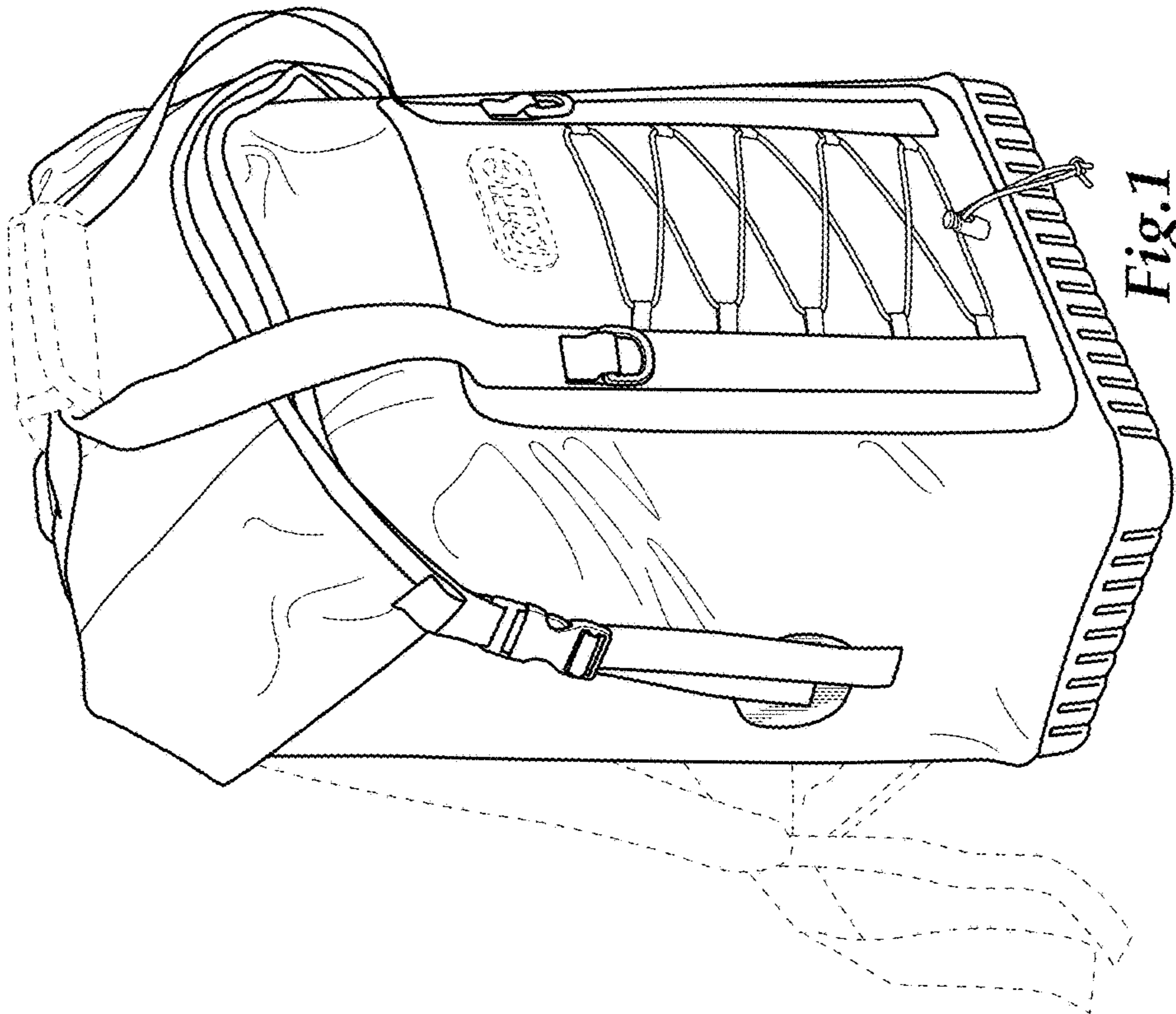

*Fig. 1*

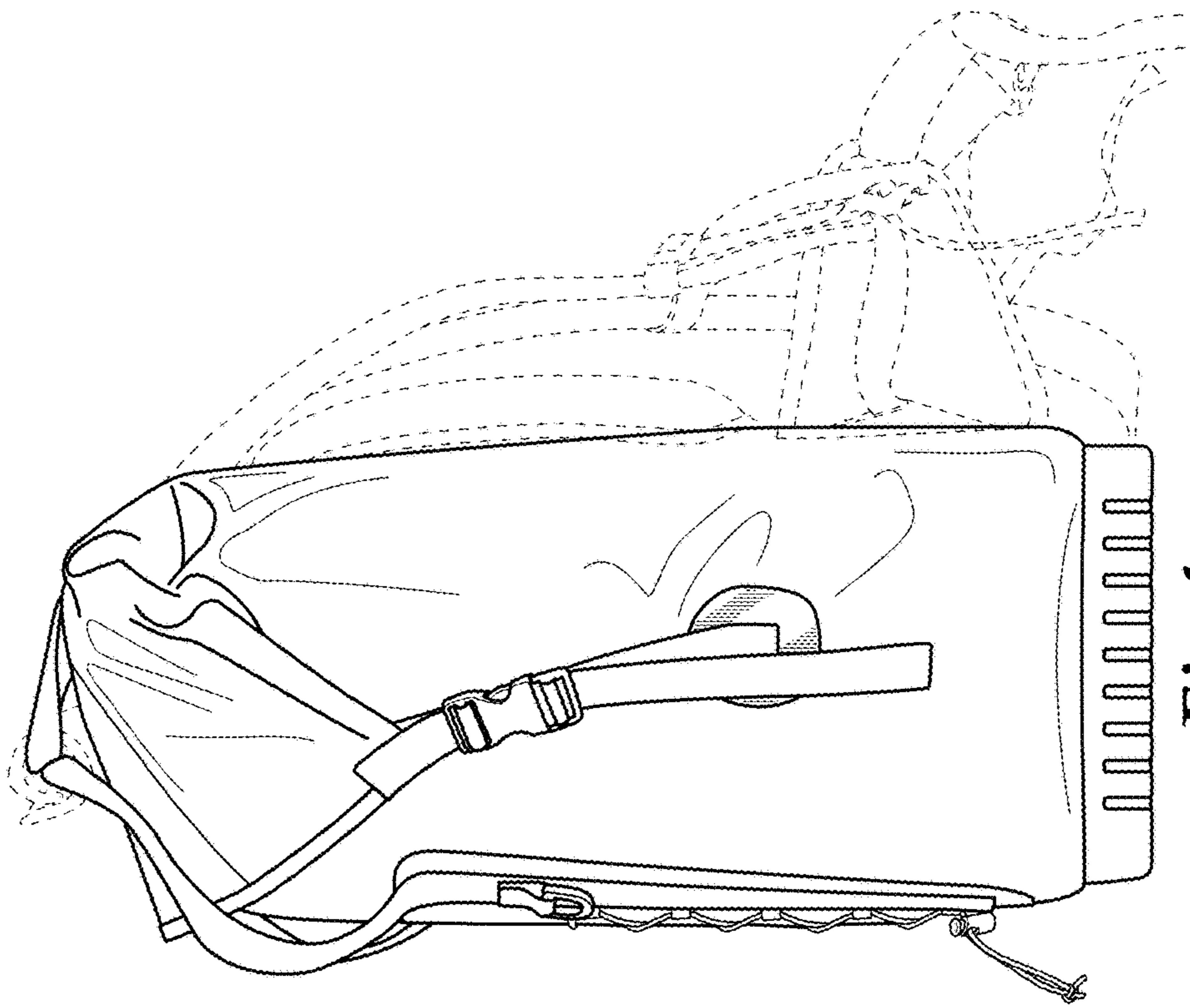

*Fig. 4*

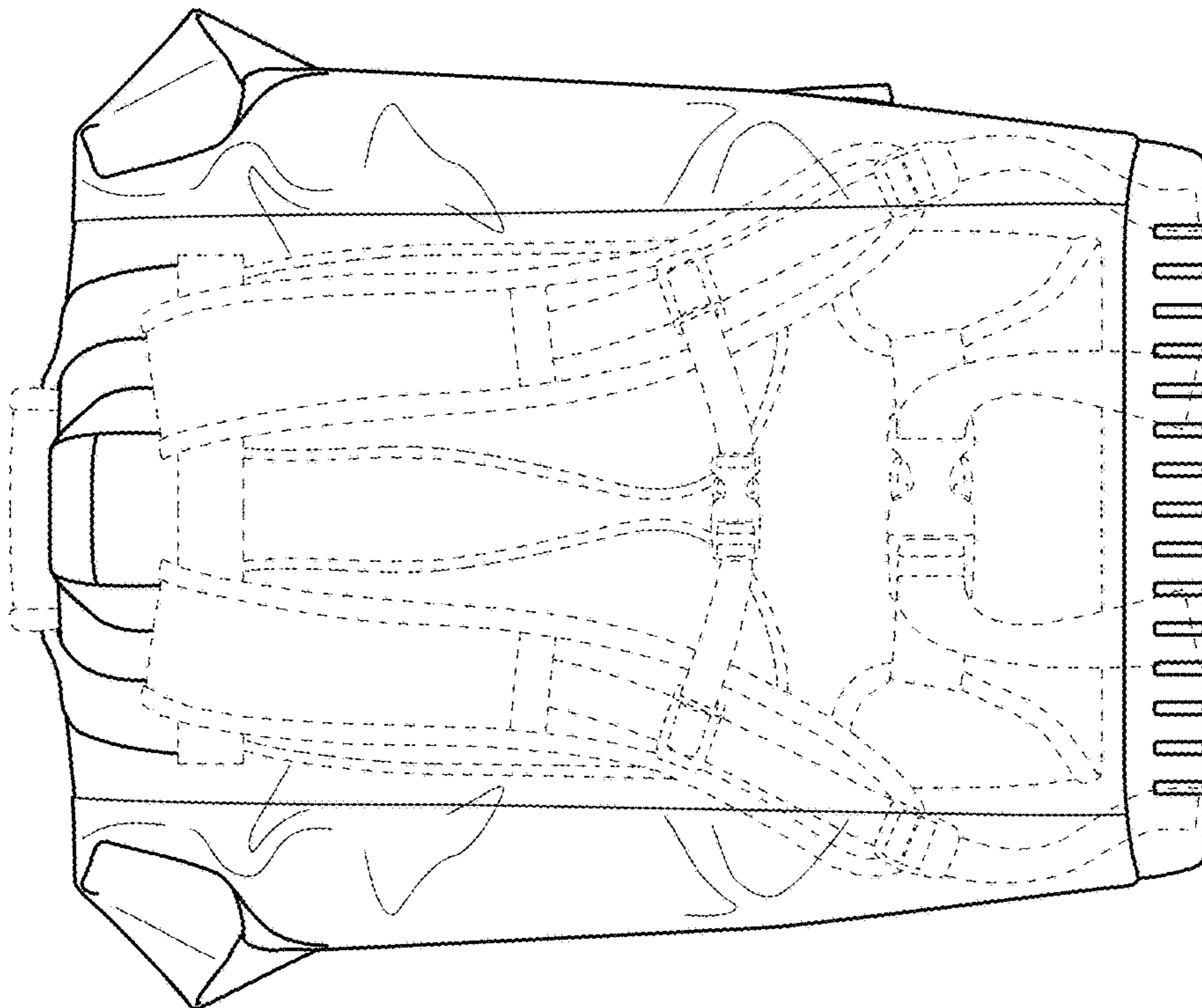

*Fig. 3*

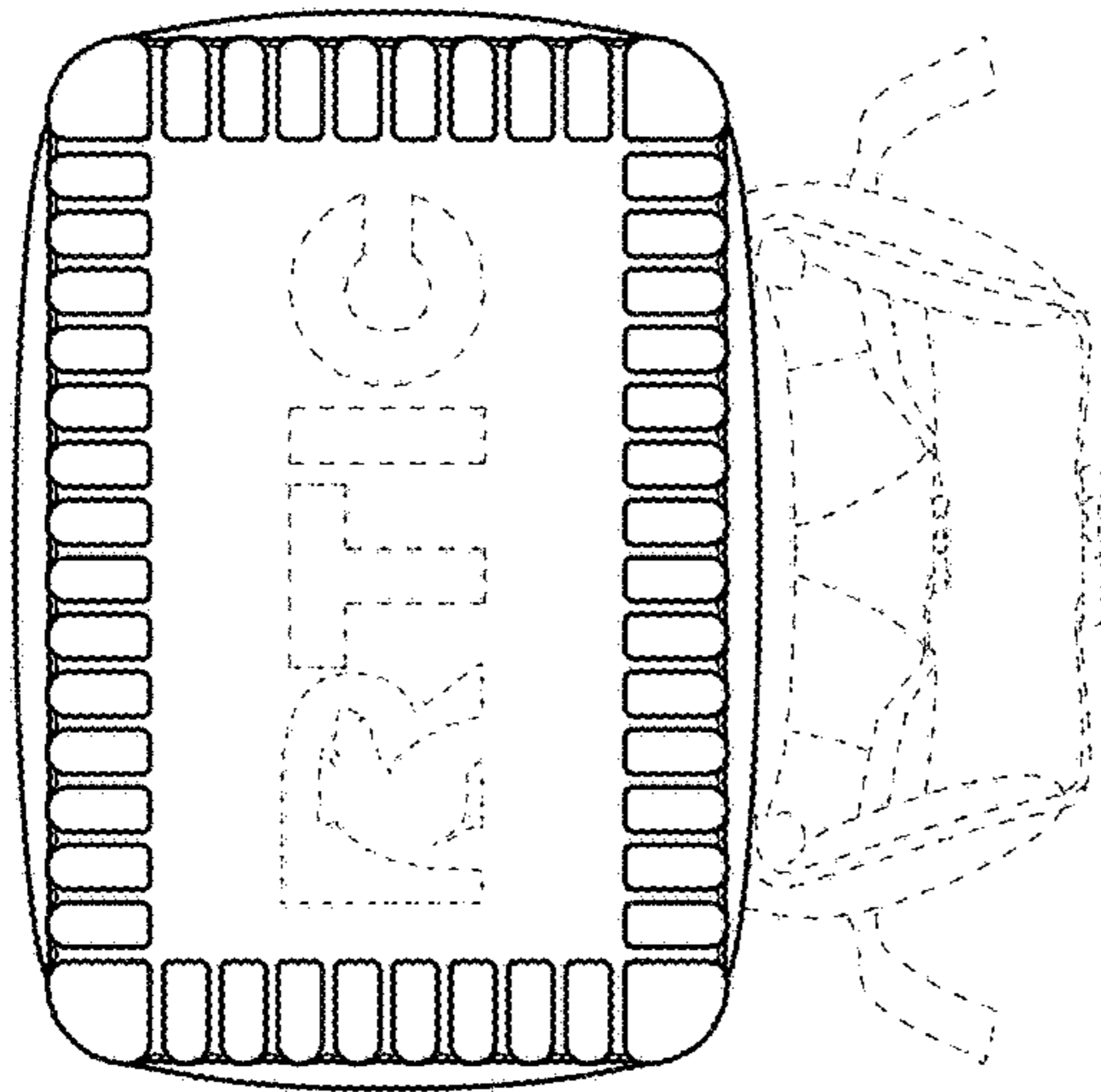

*Fig. 6*

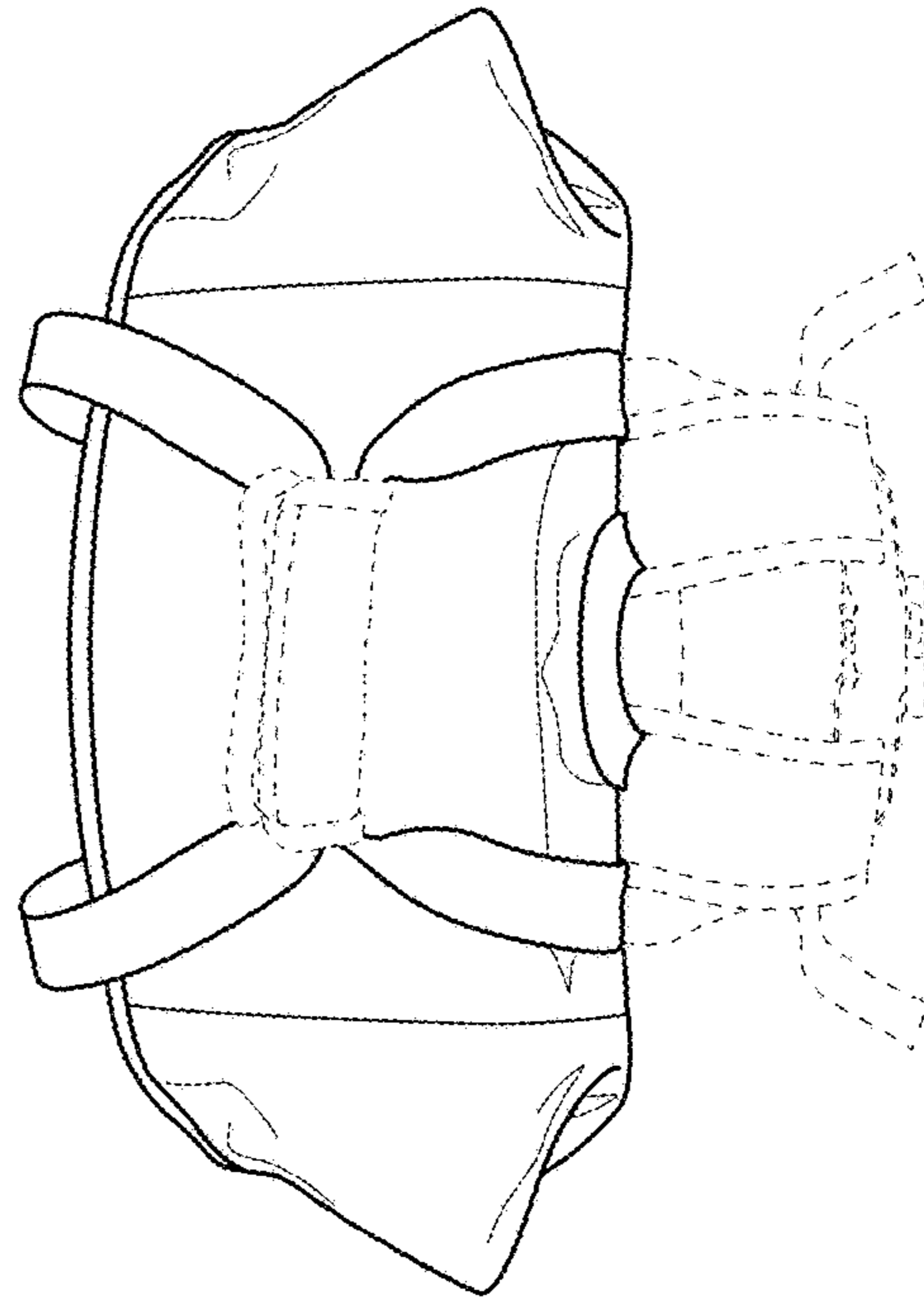

*Fig. 7*

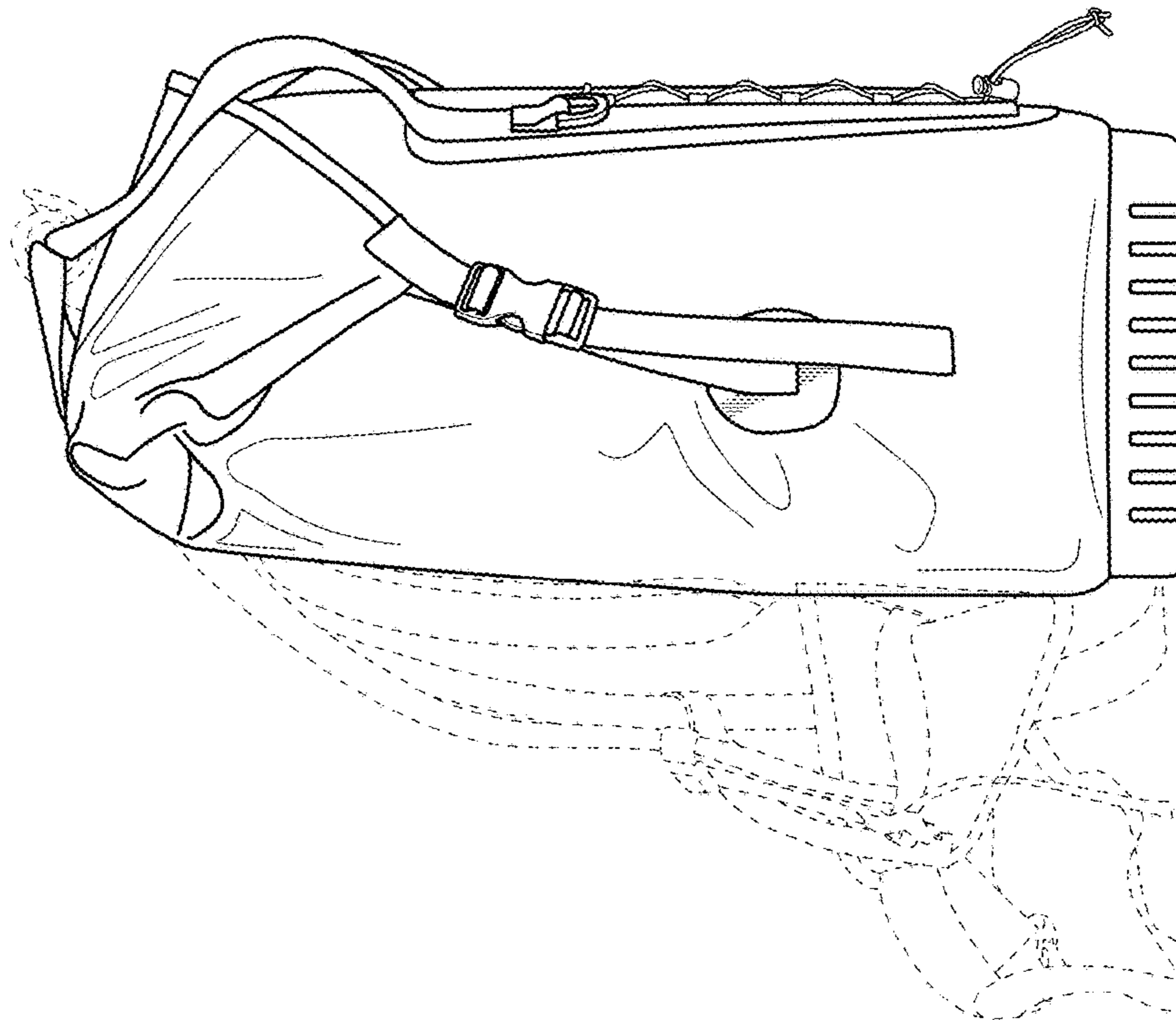

*Fig. 5*

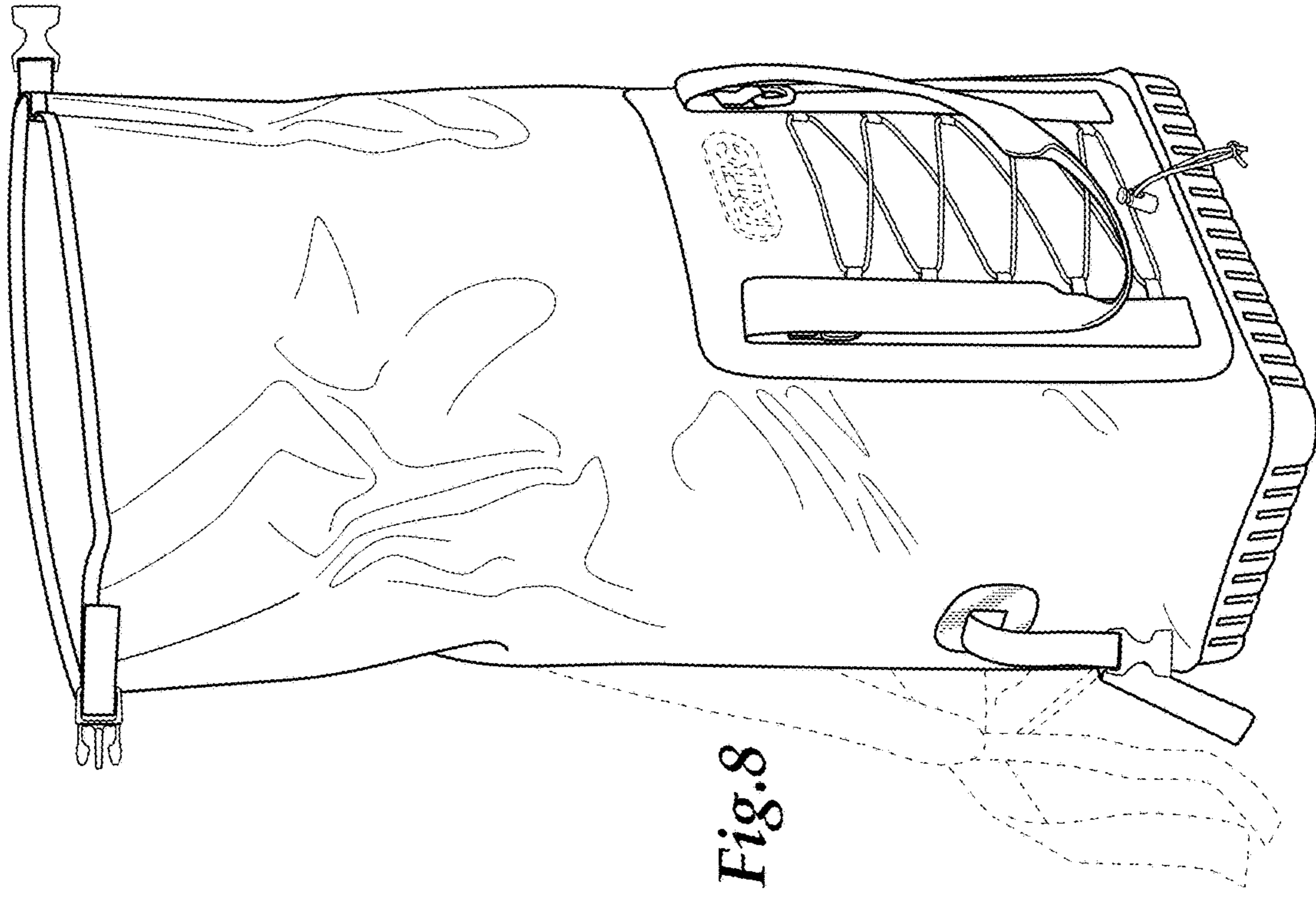
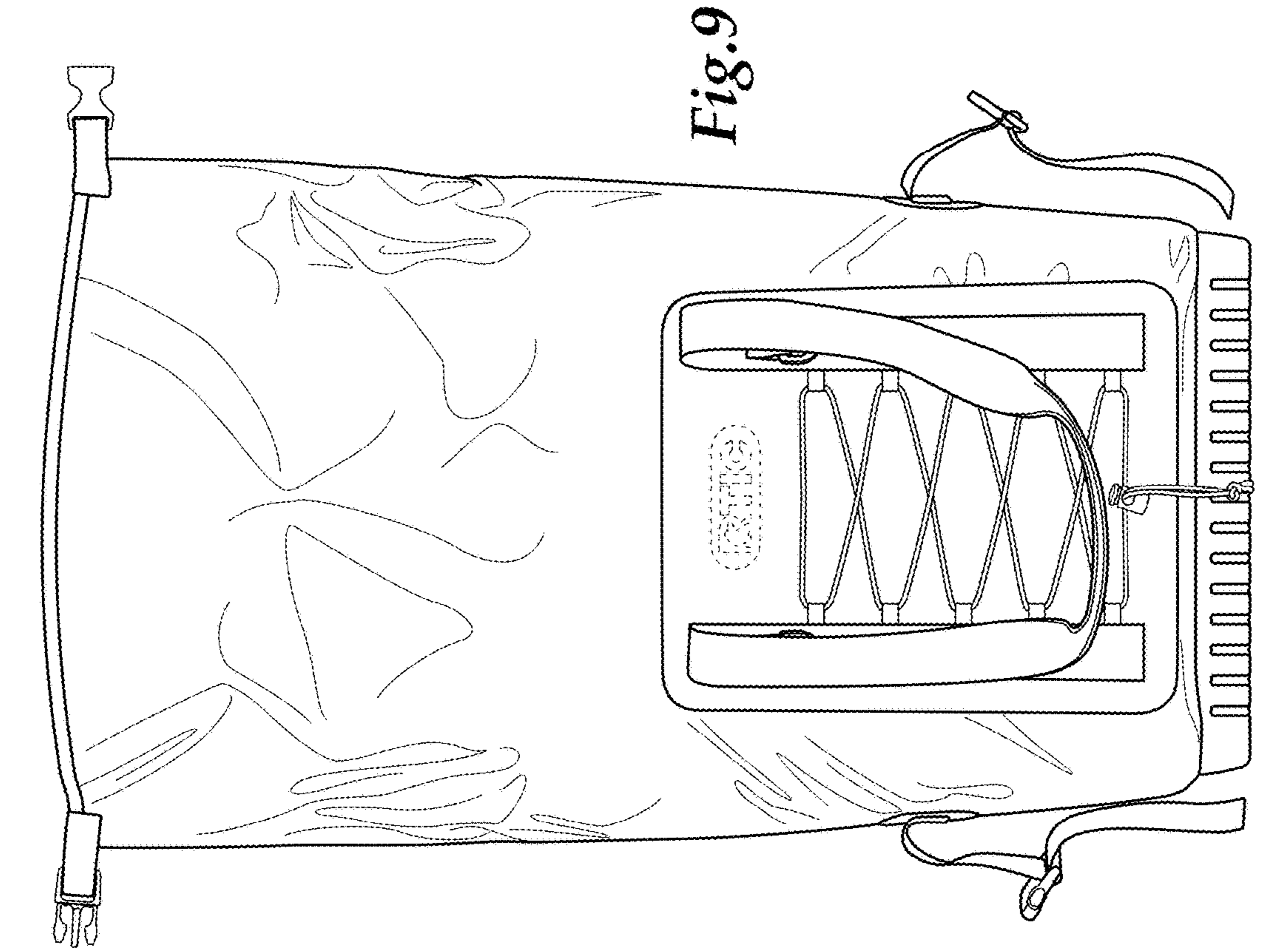

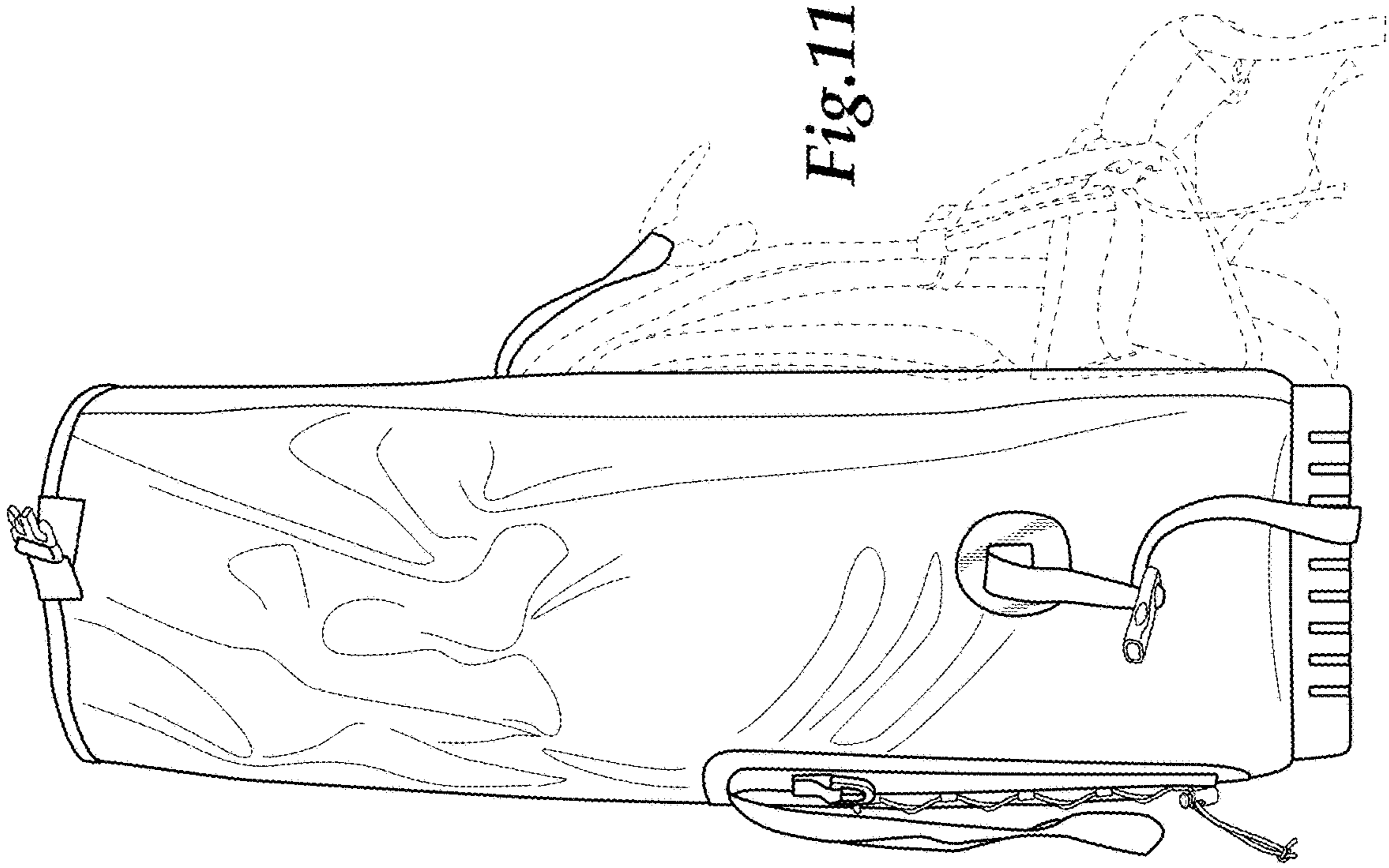

Fig. 11

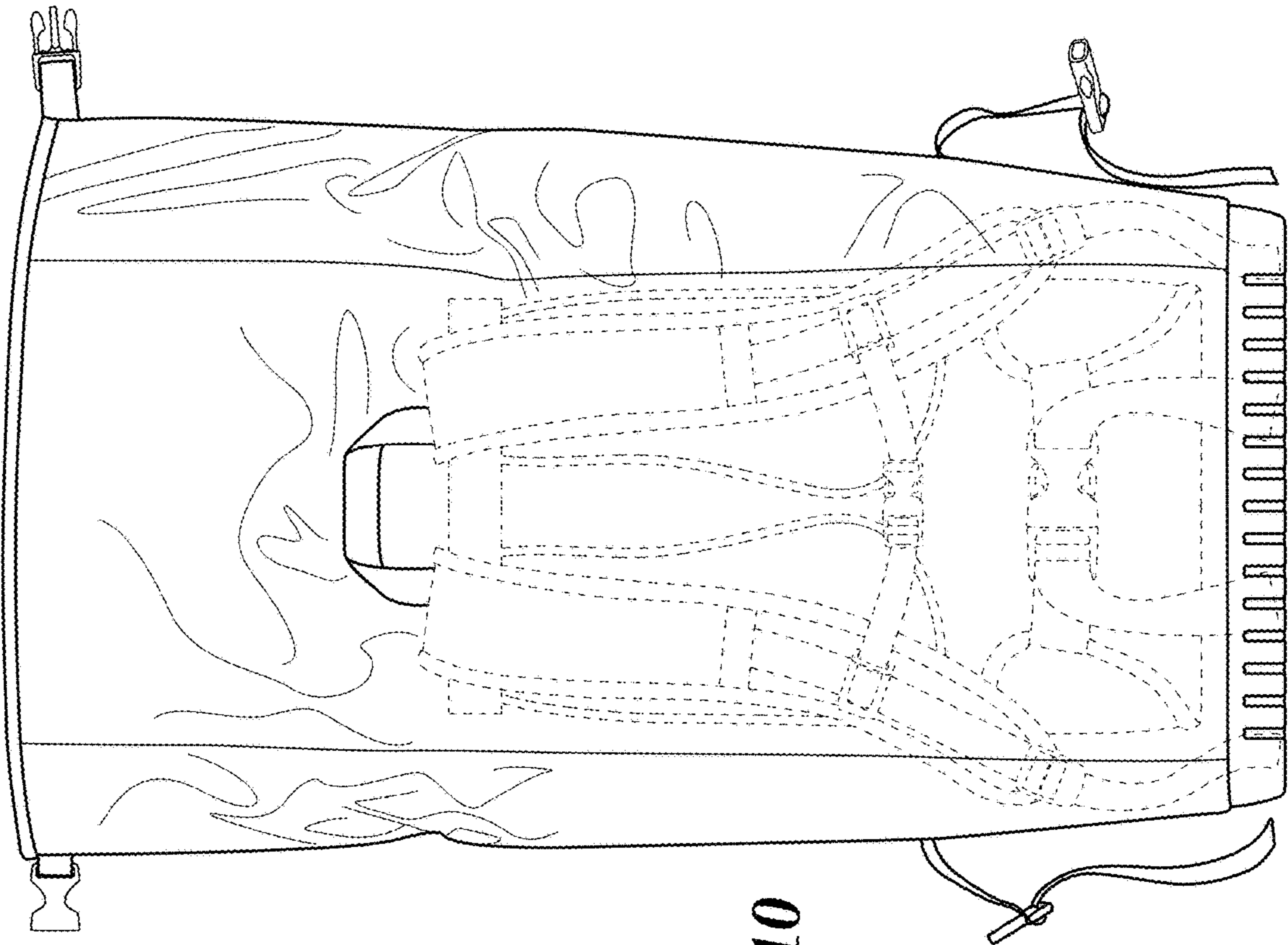
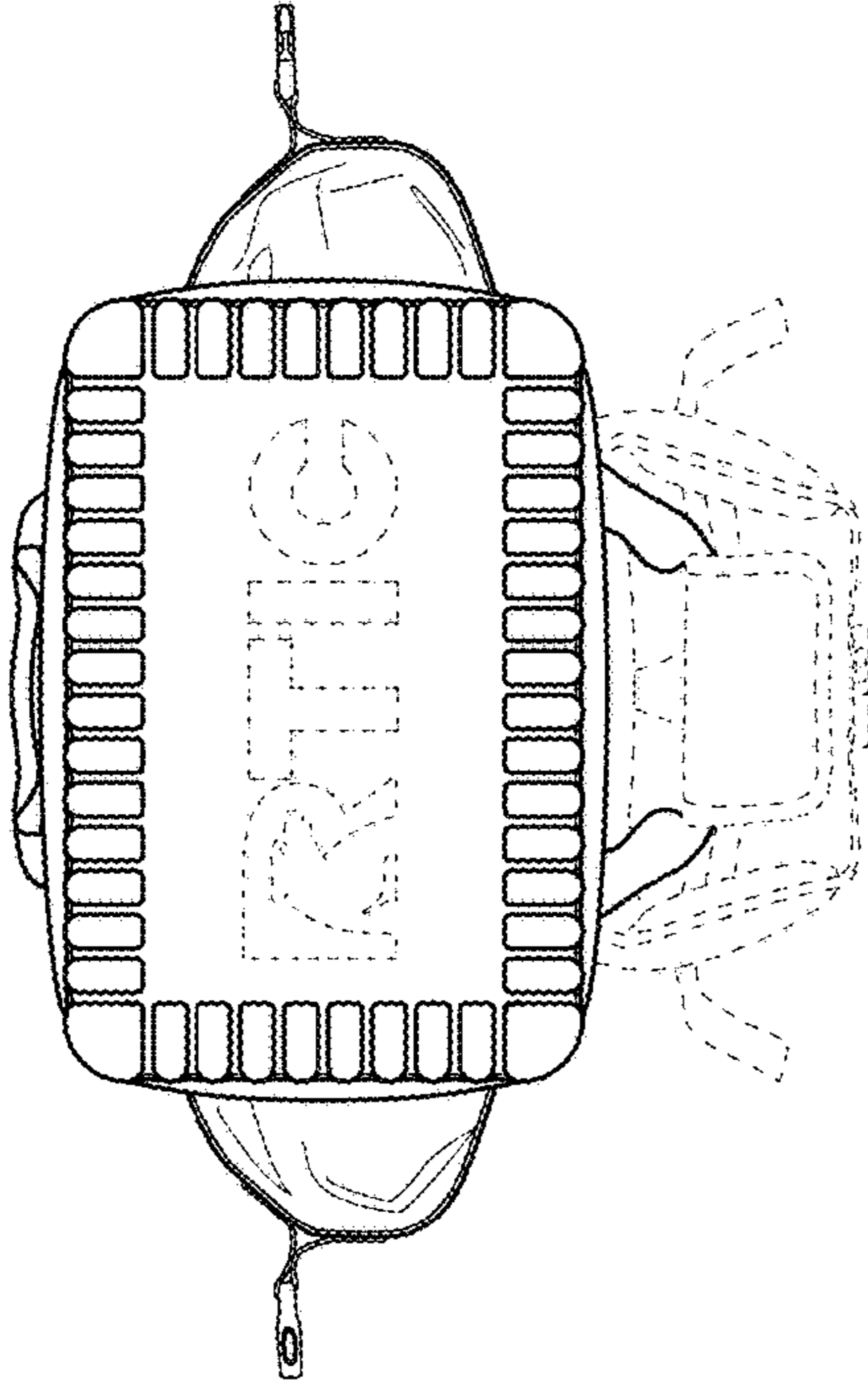
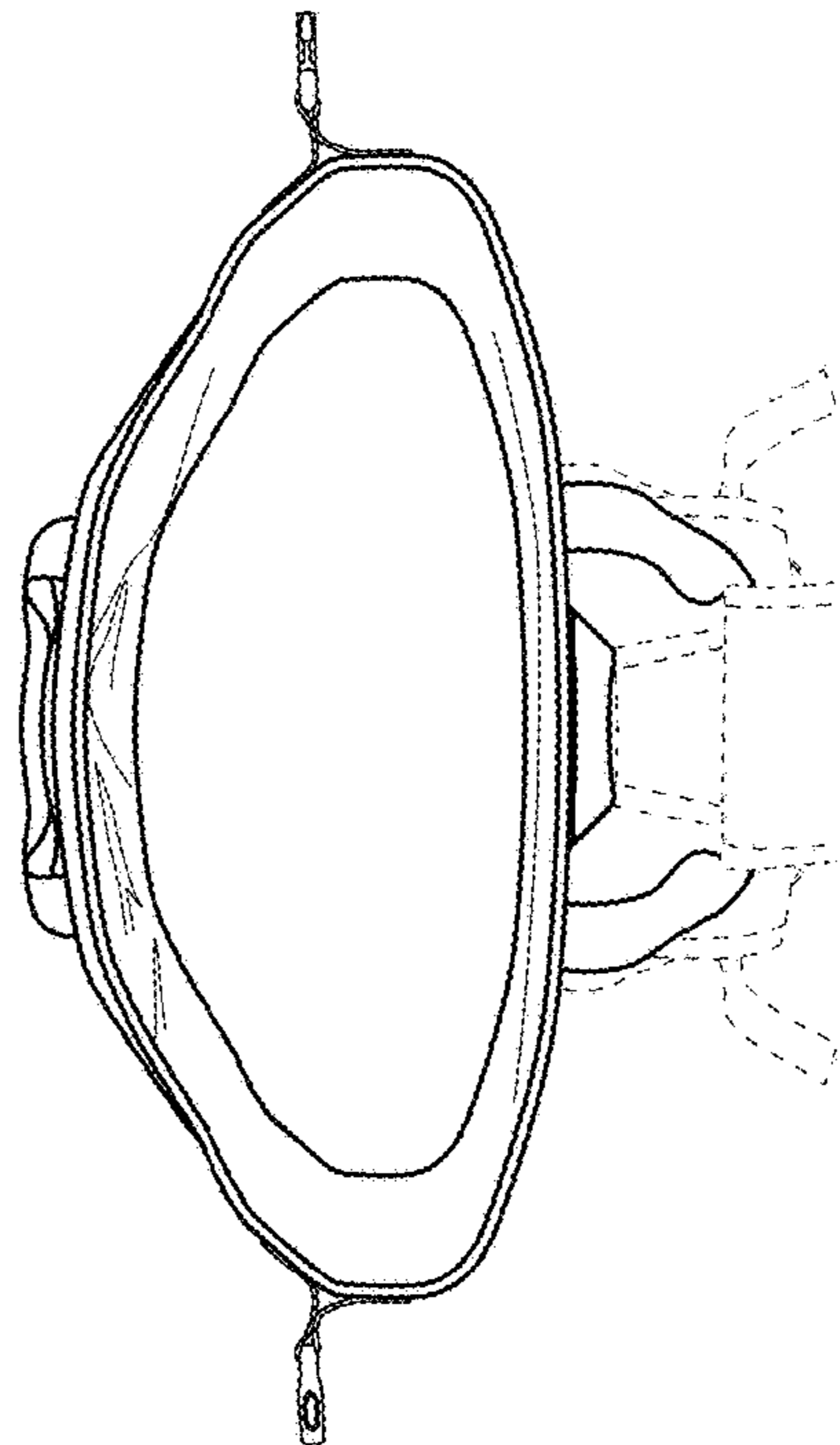

Fig. 10



*Fig. 13*



*Fig. 14*

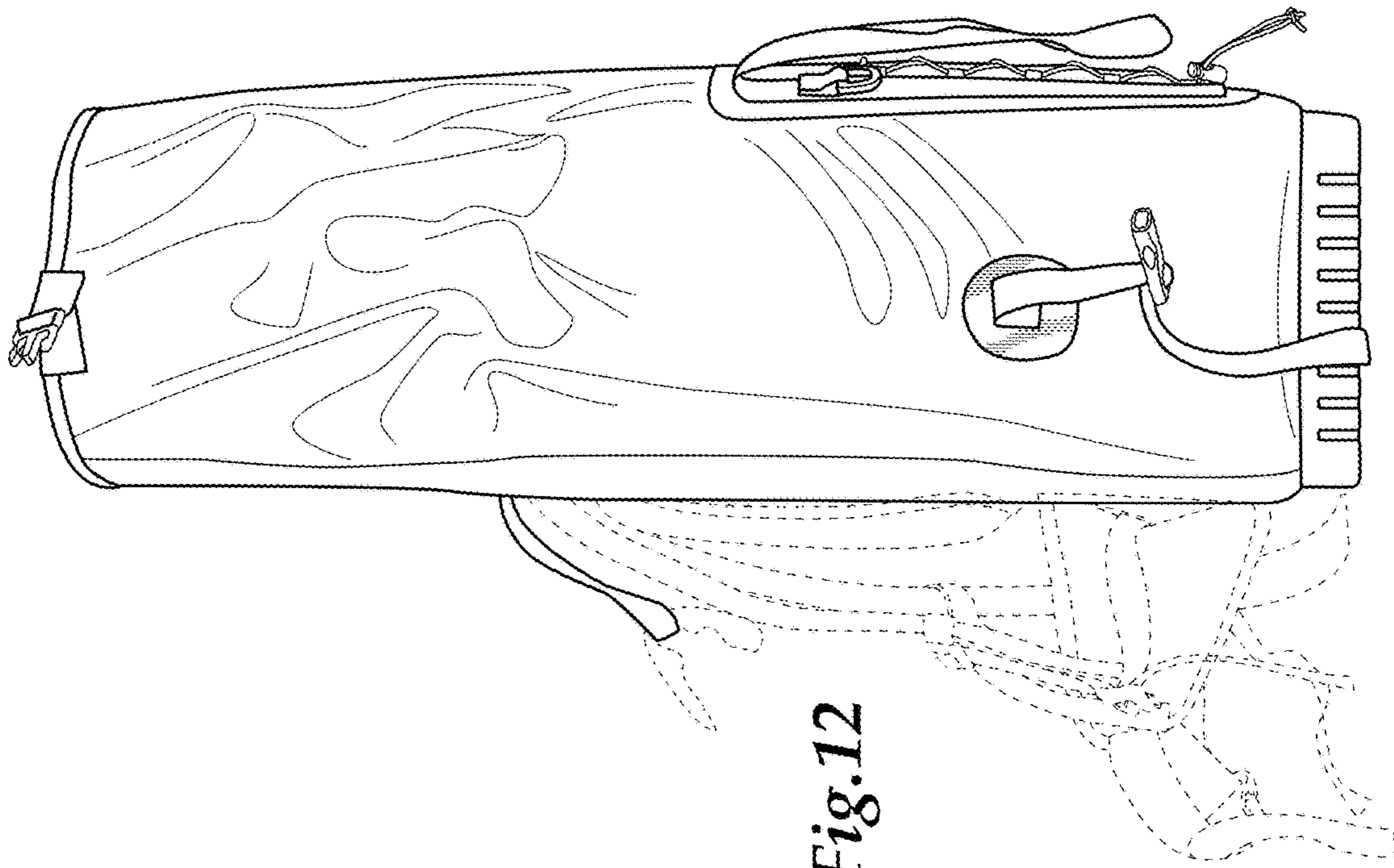

*Fig. 12*