



US00D828608S

(12) **United States Design Patent** (10) **Patent No.:** **US D828,608 S**
Botti (45) **Date of Patent:** **** Sep. 11, 2018**

(54) **WALL LAMP**

8/033; F21S 8/035-8/037; F21S 8/04;
F21S 8/043; F21S 8/063

(71) Applicant: **SIMES S.P.A.**, Nigoline di Corte
Franca (IT)

See application file for complete search history.

(72) Inventor: **Roberto Botti**, Brescia (IT)

(56) **References Cited**

(73) Assignee: **SIMES S.p.A.**, Nigoline di Corte
Franca (IT)

U.S. PATENT DOCUMENTS

(**) Term: **15 Years**

D158,803 S * 5/1950 Russell D26/76
D189,256 S * 11/1960 Rothman D26/76
D311,967 S * 11/1990 Herst D26/76
D386,278 S * 11/1997 Engle D26/76

(Continued)

(21) Appl. No.: **35/503,280**

Primary Examiner — George D. Kirschbaum

(22) Filed: **Apr. 26, 2017**

Assistant Examiner — Natasha Vujcic

(80) **Hague Agreement Data**

Int. Filing Date: **Apr. 26, 2017**

Int. Reg. No.: **DM/096561**

Int. Reg. Date: **Apr. 26, 2017**

Int. Reg. Pub. Date: **Jul. 7, 2017**

(74) *Attorney, Agent, or Firm* — Thomas | Horstemeyer,
LLP

(57) **CLAIM**

The ornamental design for a wall lamp, as shown and described.

(30) **Foreign Application Priority Data**

Oct. 27, 2016 (WO) DM/093633

(51) **LOC (11) Cl.** **26-05**

(52) **U.S. Cl.**
USPC **D26/85**

(58) **Field of Classification Search**

USPC ... D26/3, 28, 76, 78, 79, 80, 81, 82, 83, 85,
D26/86, 88, 90, 93, 111, 113, 118, 119,
D26/120, 121, 122, 138, 139, 140, 141,
D26/142, 152

CPC F21S 2/00; F21S 4/00; F21S 4/003; F21S
4/005; F21S 4/006; F21S 4/007; F21S
4/008; F21S 6/00; F21S 8/00; F21S
8/024; F21S 8/026; F21S 8/031; F21S

DESCRIPTION

1.-4. Wall lamp

1.1 is a front perspective view;

1.2 is a front view;

1.3 is a bottom plan view;

1.4 is a top plan view;

1.5 is a right side view;

1.6 is a left side view;

2.1 is a front perspective view;

2.2 is a front view;

2.3 is a bottom plan view;

2.4 is a top plan view;

2.5 is a right side view;

2.6 is a left side view;

3.1 is a front perspective view;

3.2 is a front view;

3.3 is a bottom plan view;

3.4 is a top plan view;

3.5 is a right side view;

3.6 is a left side view;

4.1 is a front perspective view;

(Continued)

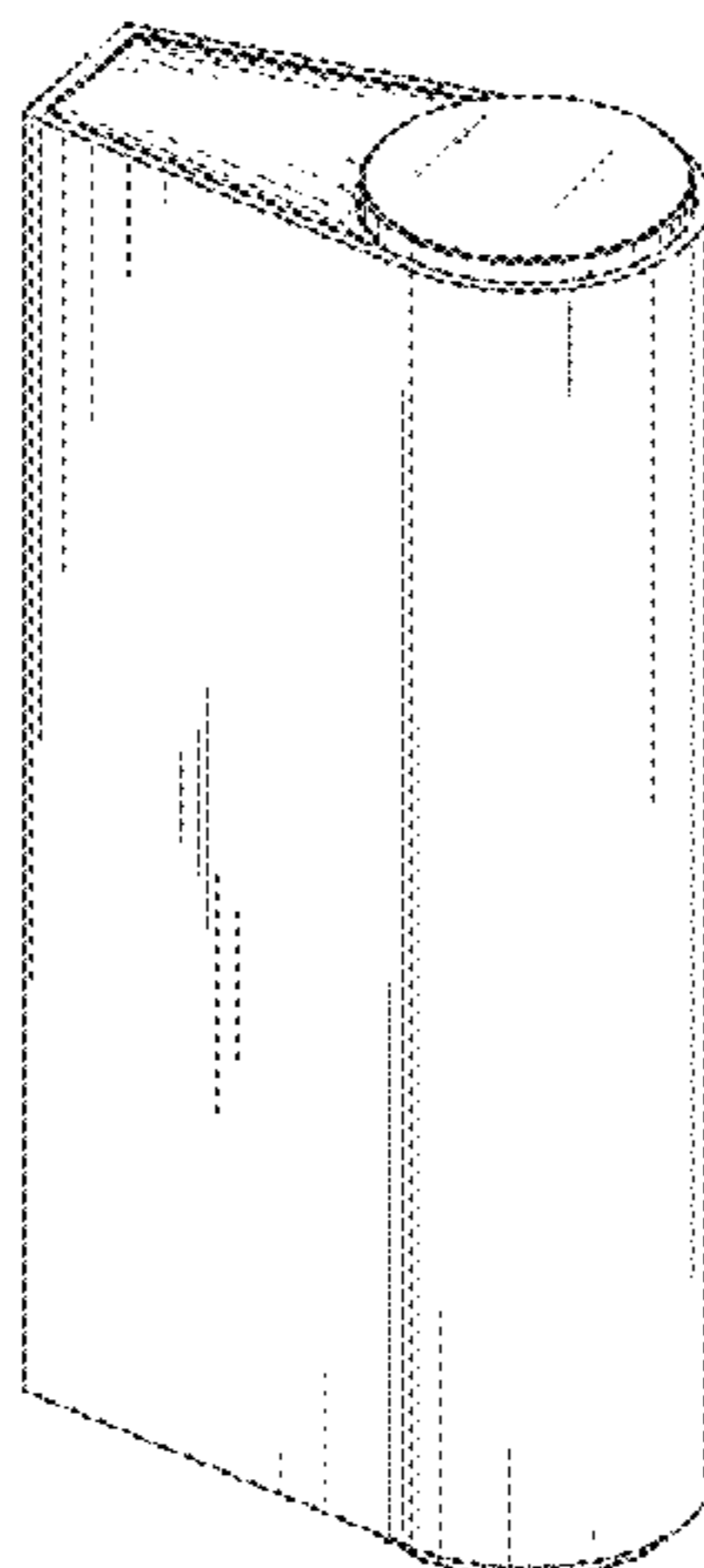

- 4.2 is a front view;
- 4.3 is a bottom plan view;
- 4.4 is a top plan view;
- 4.5 is a right side view;
- 4.6 is a left side view.

1 Claim, 24 Drawing Sheets

(56)

References Cited

U.S. PATENT DOCUMENTS

D412,592 S *	8/1999	Kowalenko	D26/63
D468,047 S *	12/2002	Lara	D26/85
D470,262 S *	2/2003	Yiu	D26/76
D561,927 S *	2/2008	Hoernig	D26/87
D581,079 S *	11/2008	Mier-Langner	D26/72
D589,204 S *	3/2009	Sabernig	D26/104
D633,642 S *	3/2011	Wauters	D26/76
D653,793 S *	2/2012	Marquardt	D26/80
D654,208 S *	2/2012	Marquardt	D26/85
D680,674 S *	4/2013	Jepson	D26/87
D760,939 S *	7/2016	Hoang	D26/85
D783,881 S *	4/2017	Hollander	D26/76

* cited by examiner

1.1

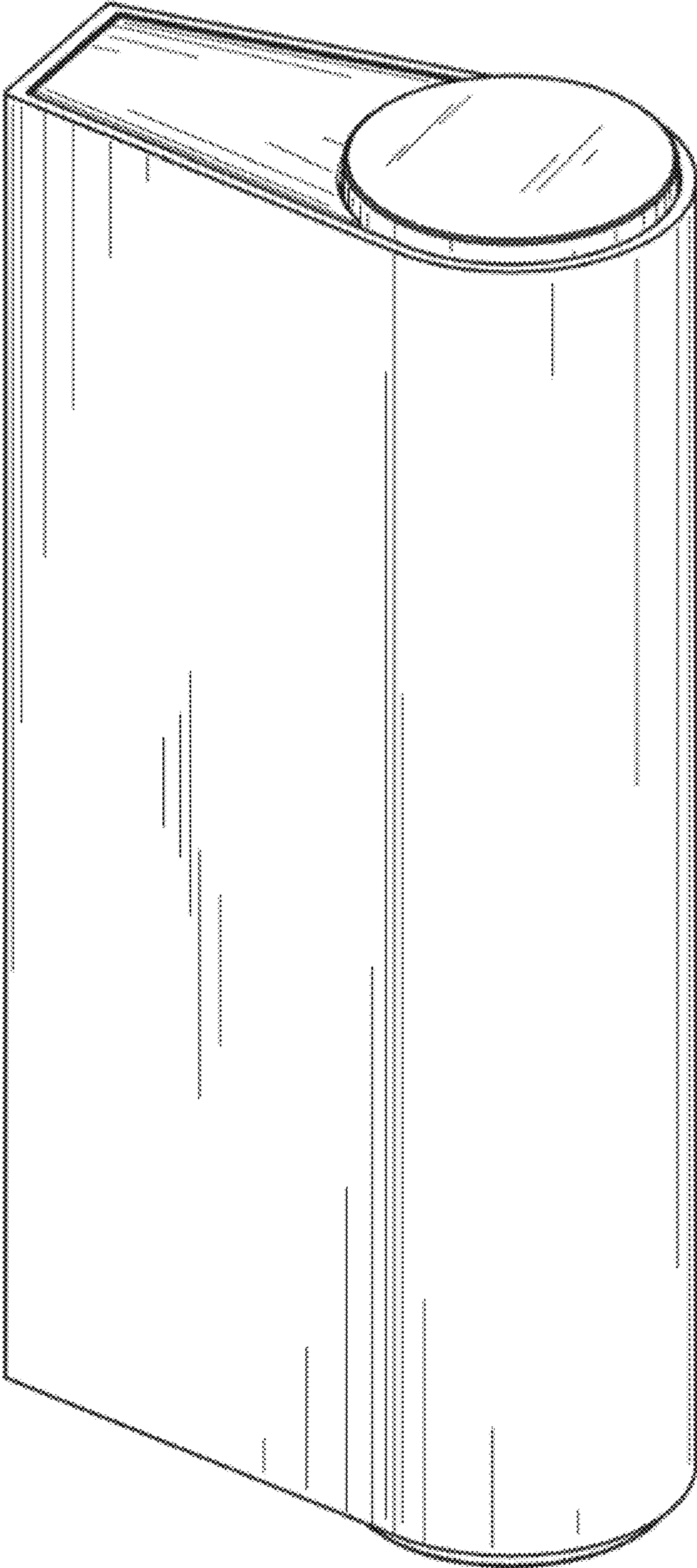

1.2

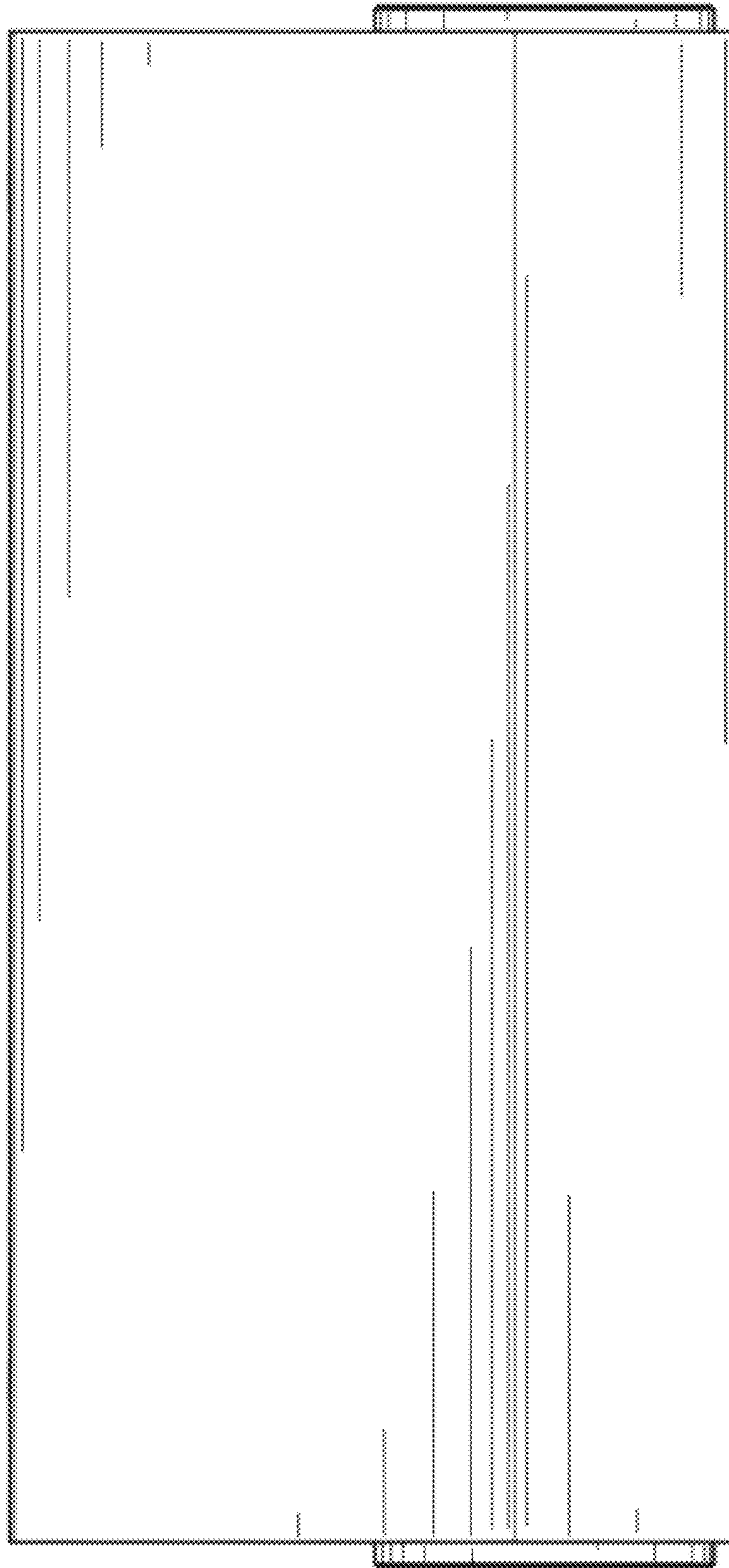

1.3

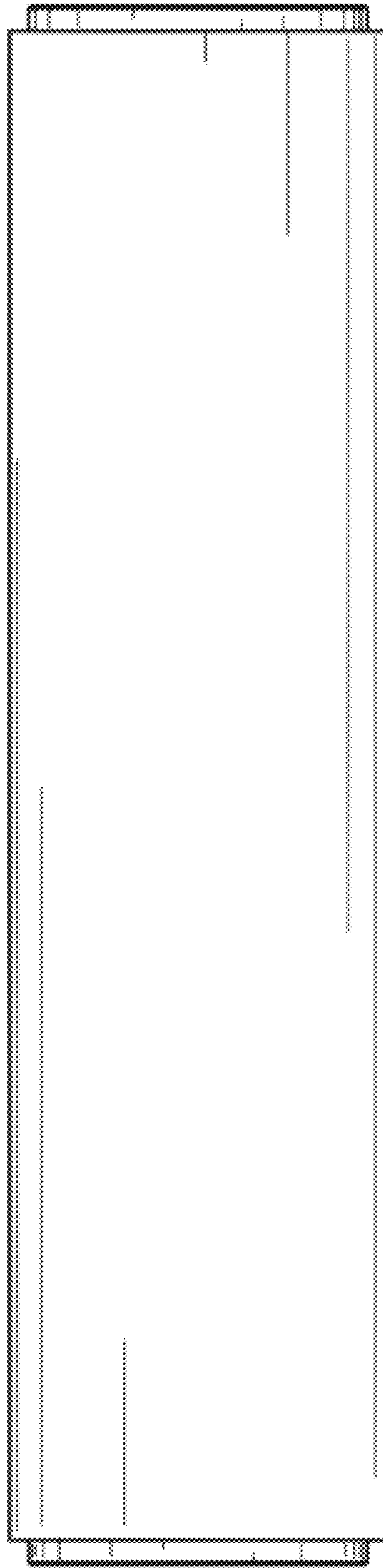

1.4

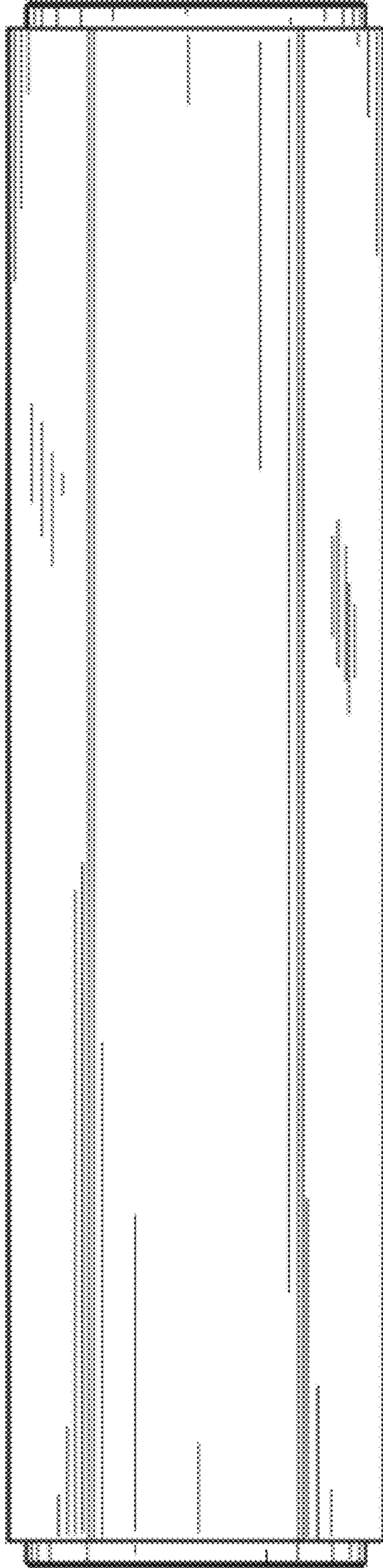

1.5

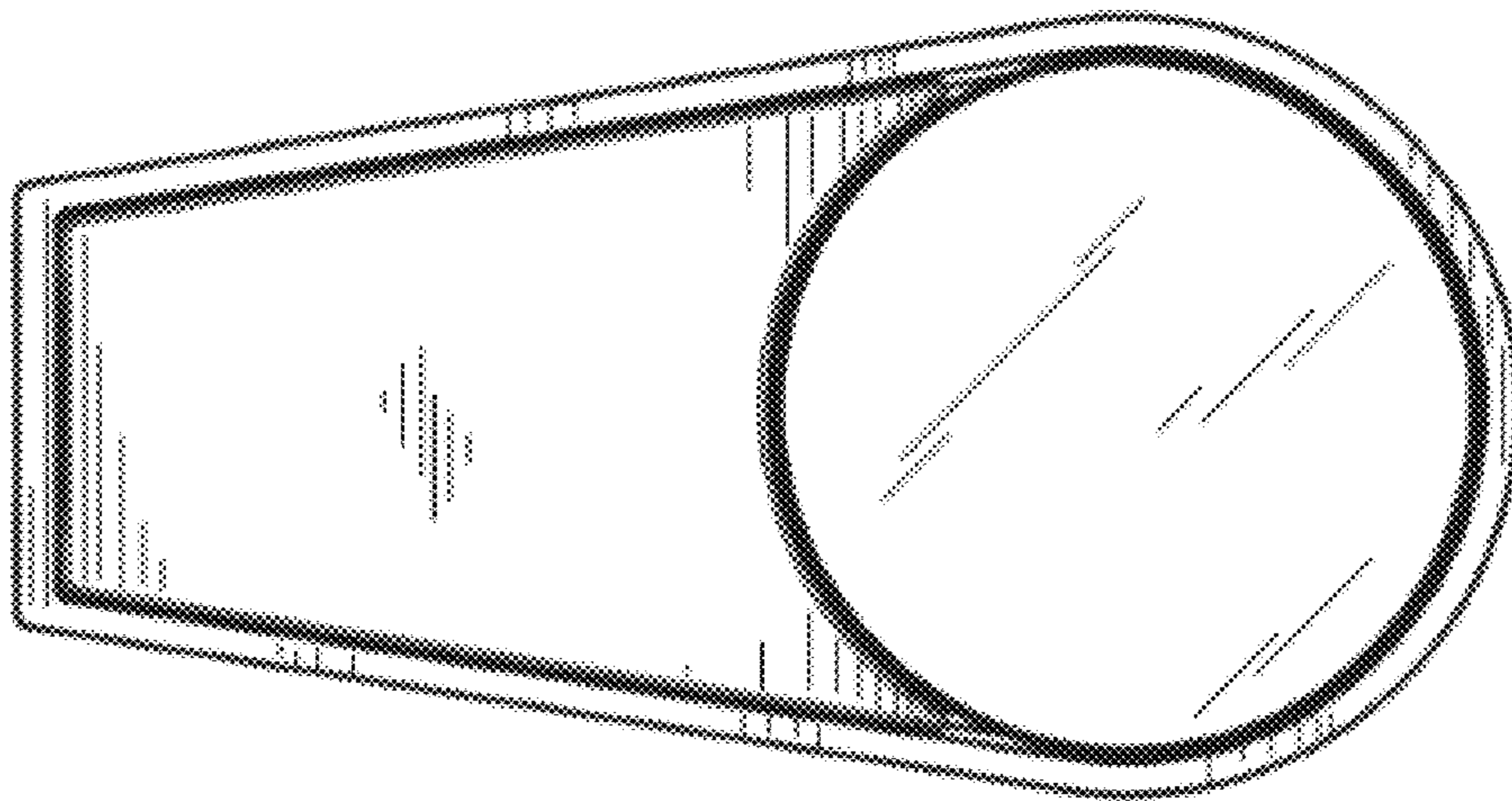

1.6

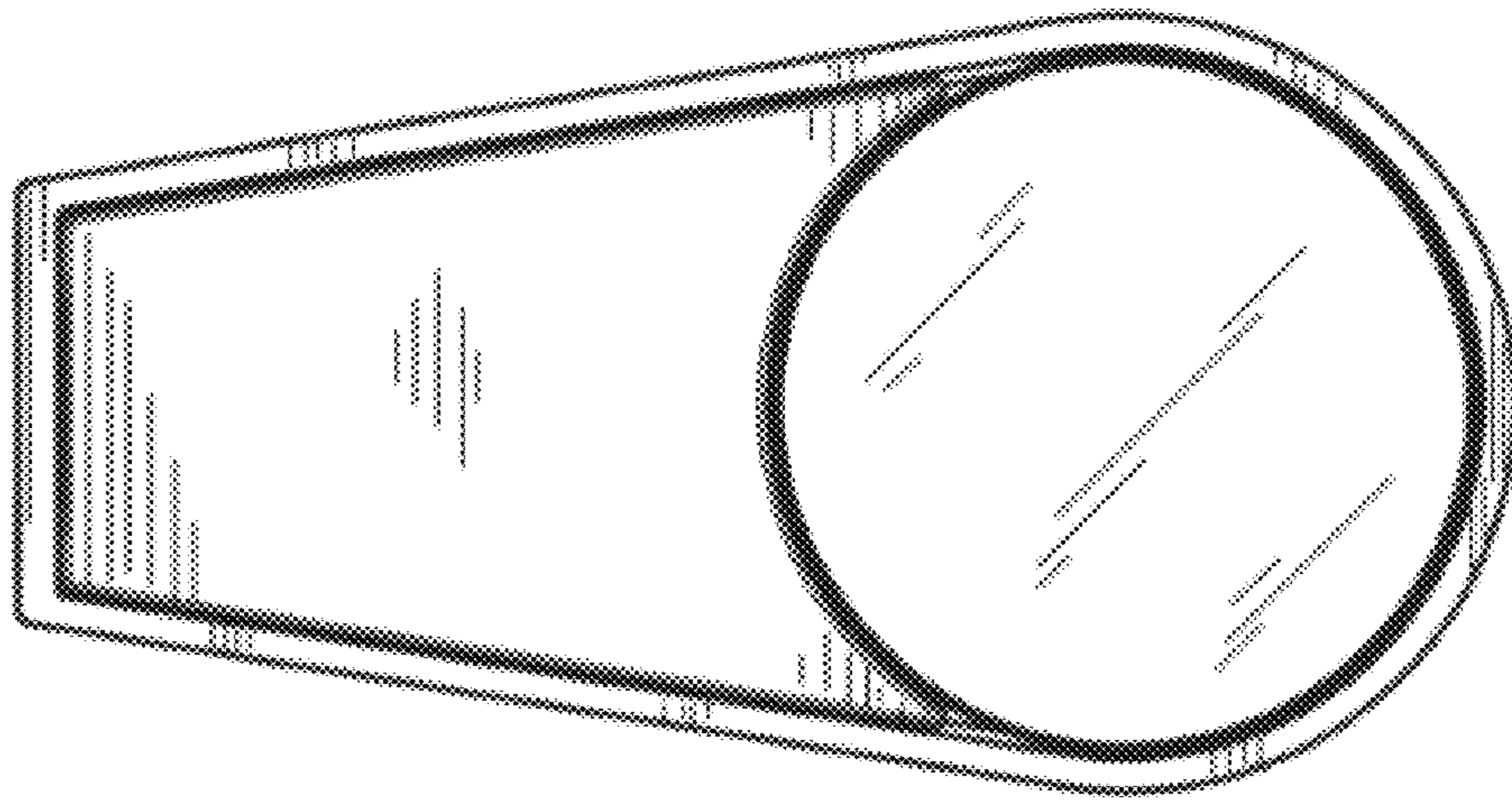

2.1

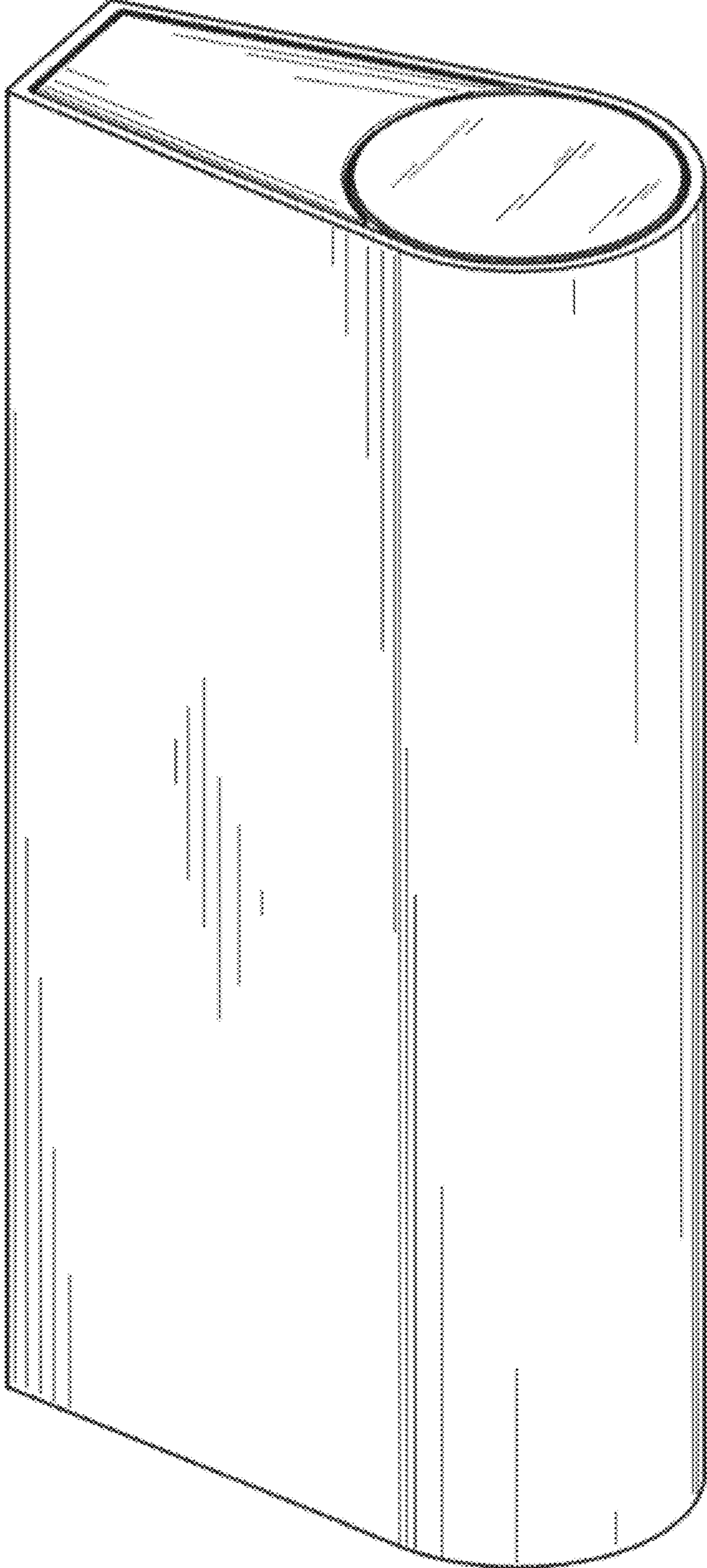

2.2

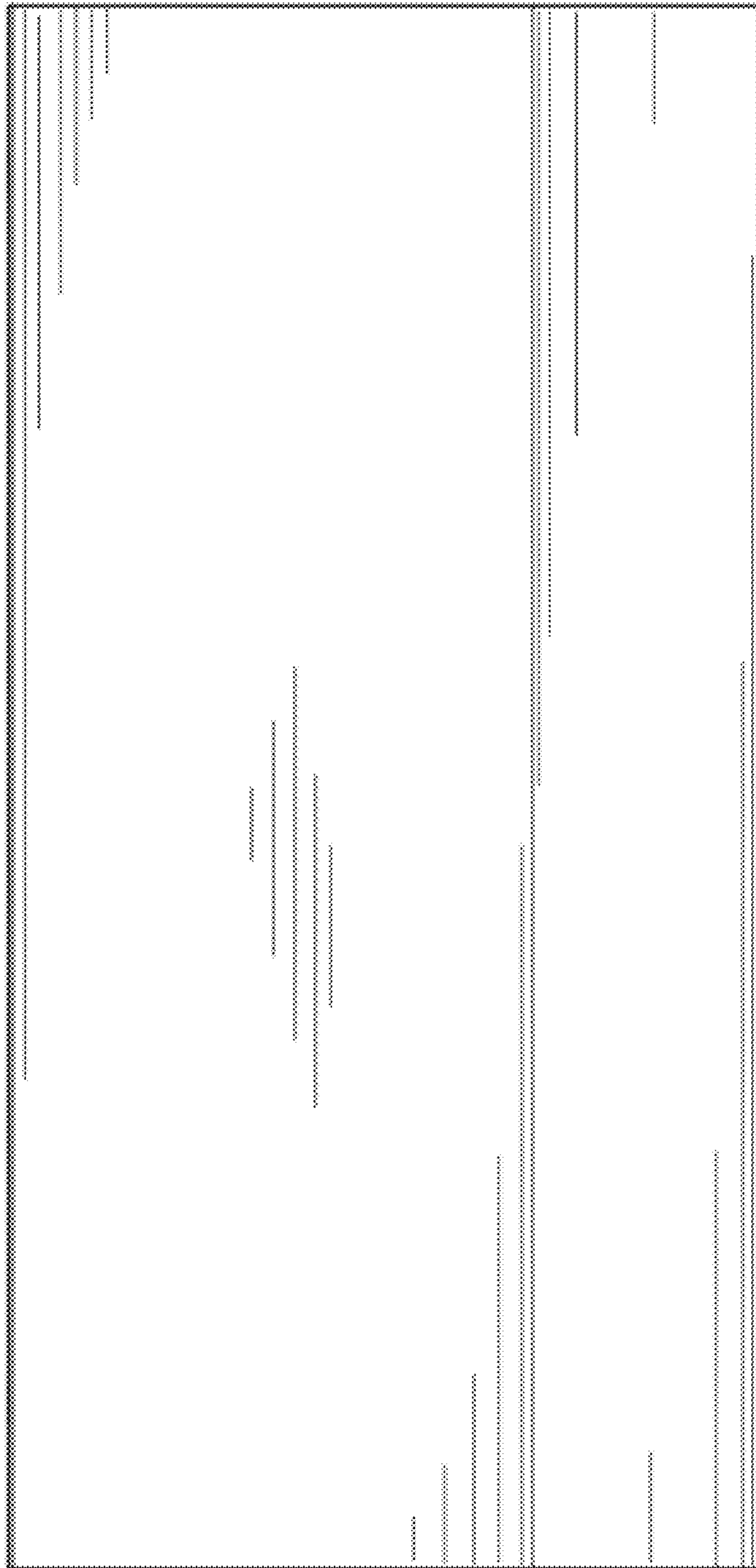

2.3

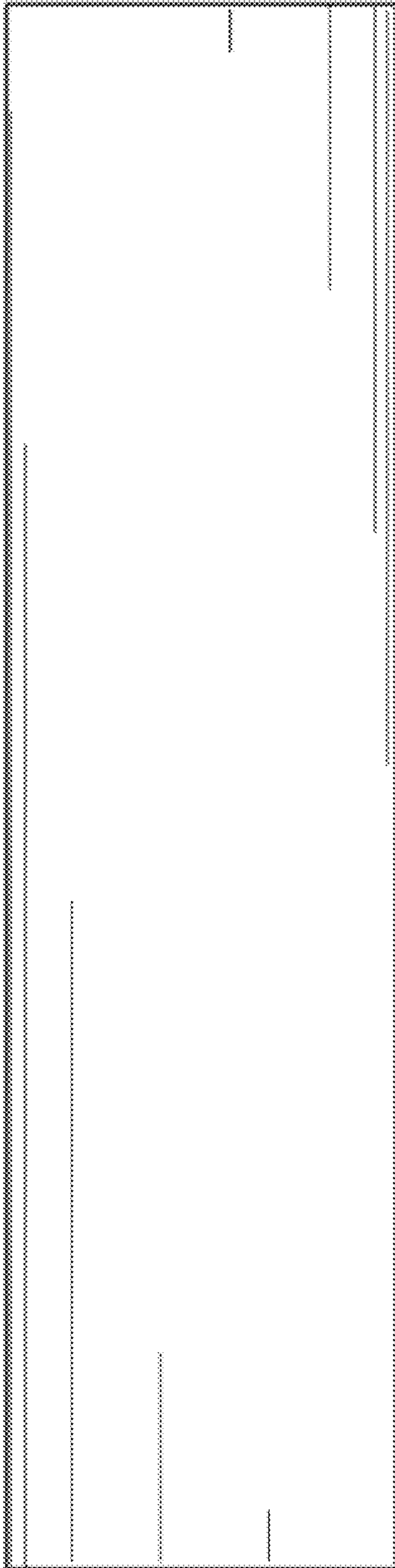

2.4

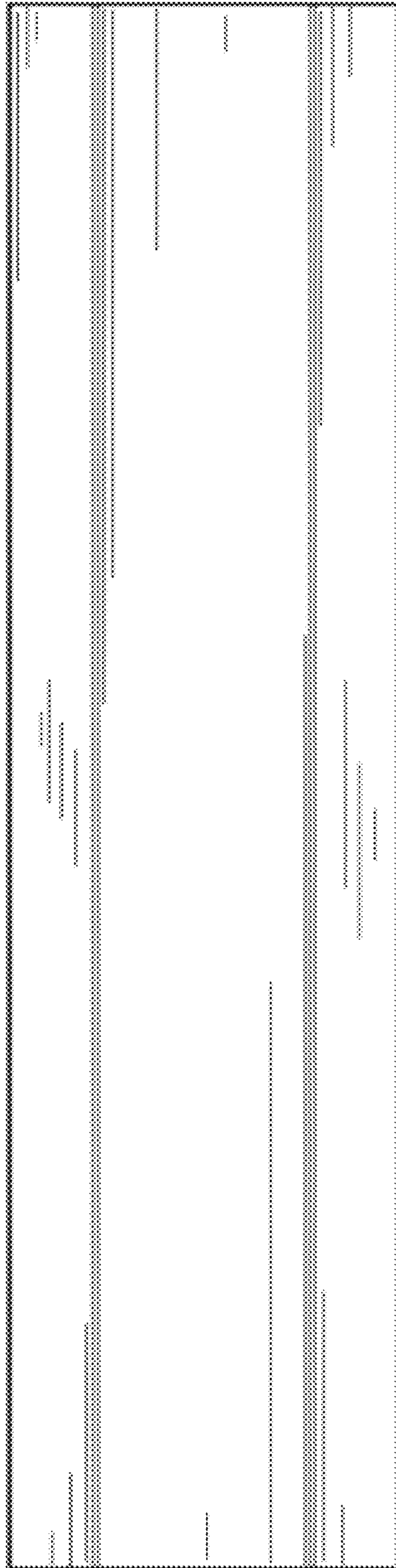

2.5

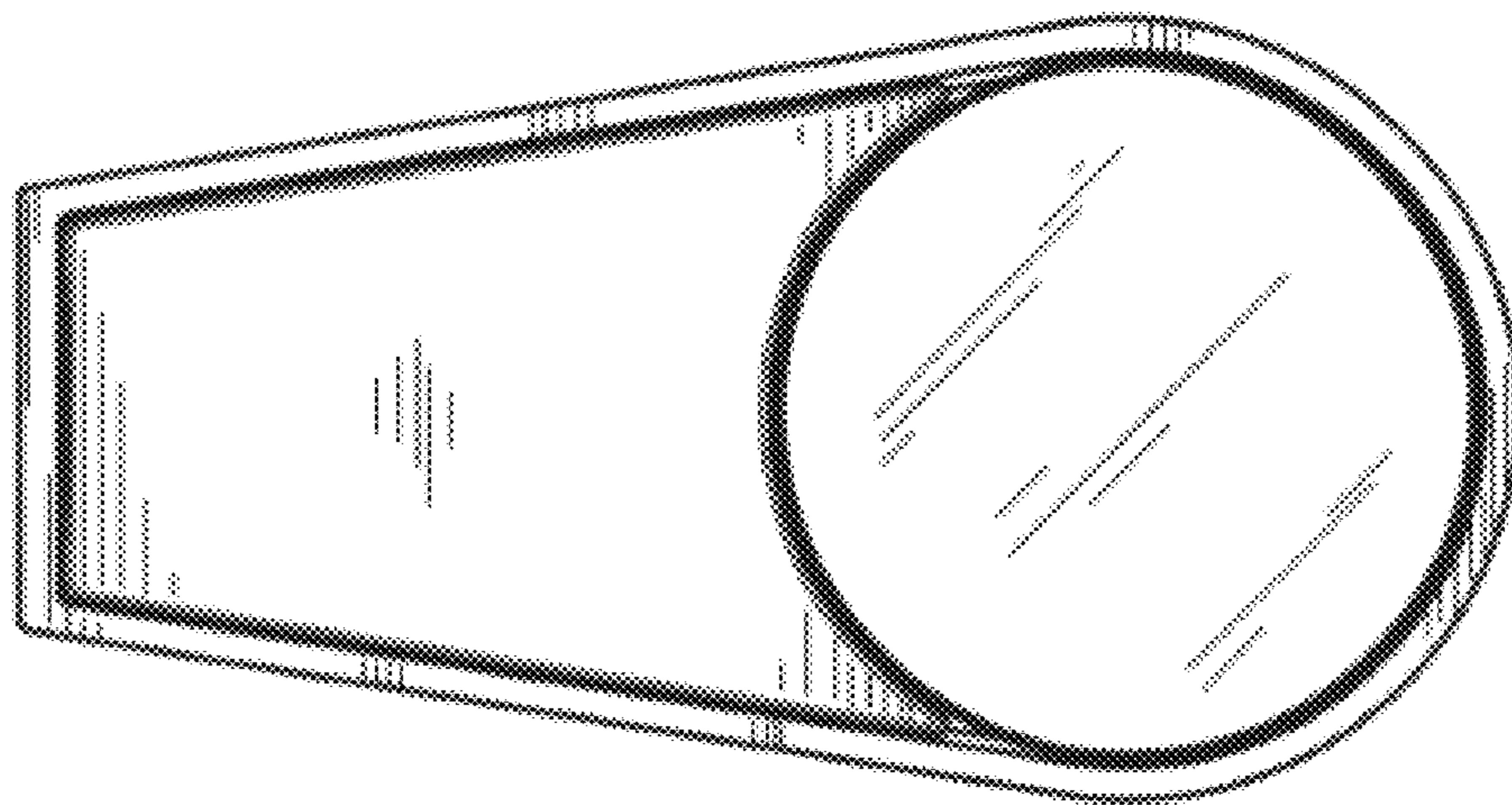

2.6

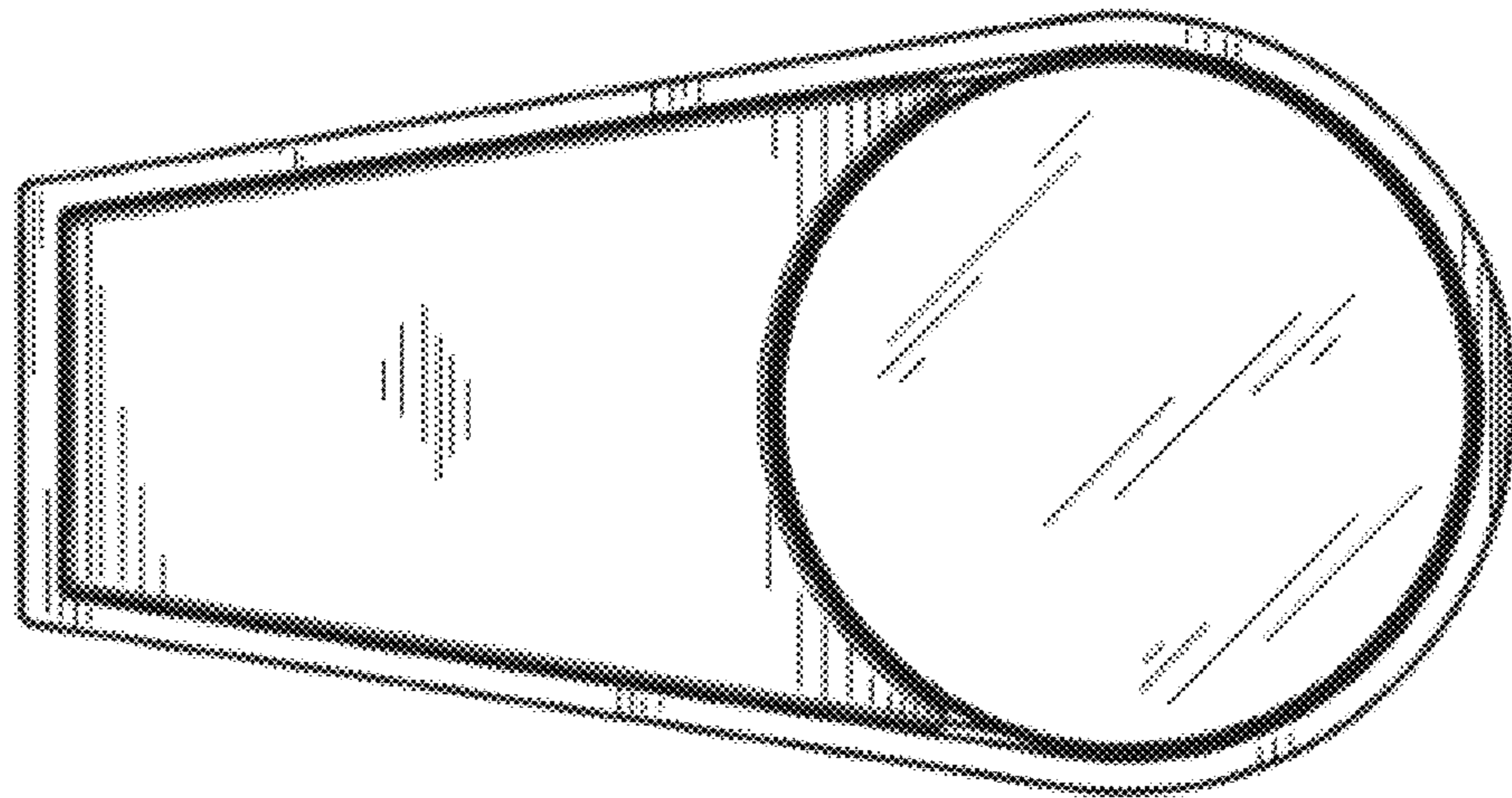

3.1

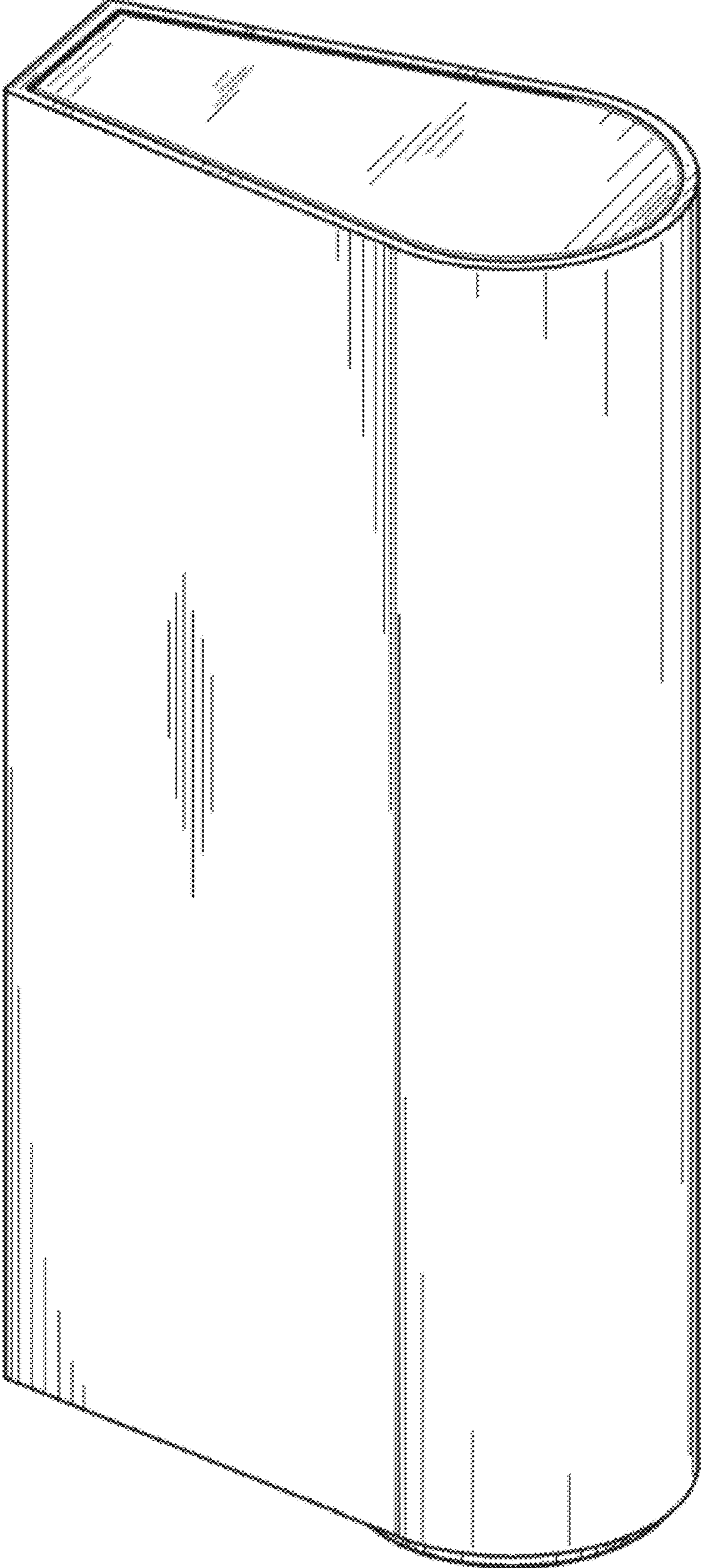

3.2

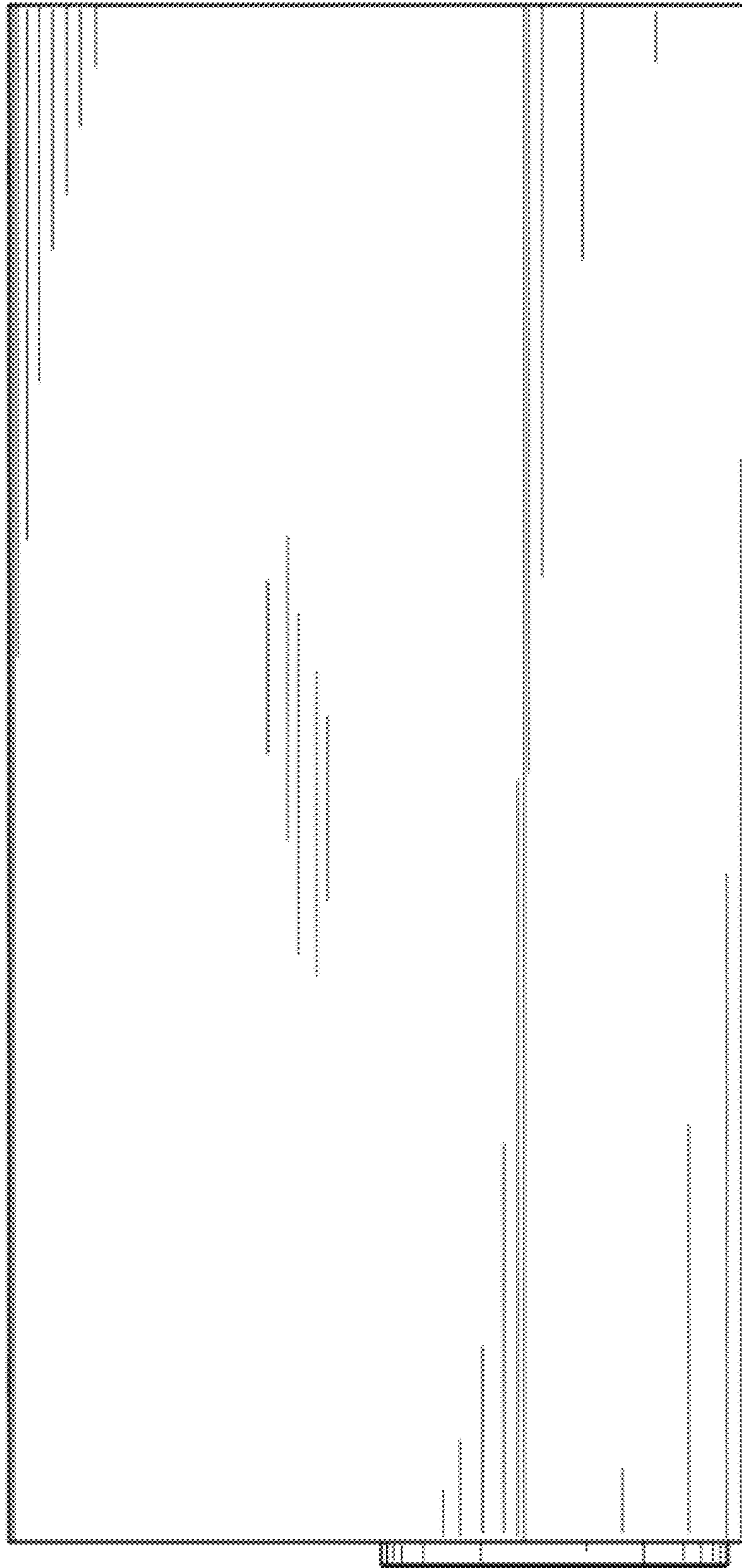

3.3

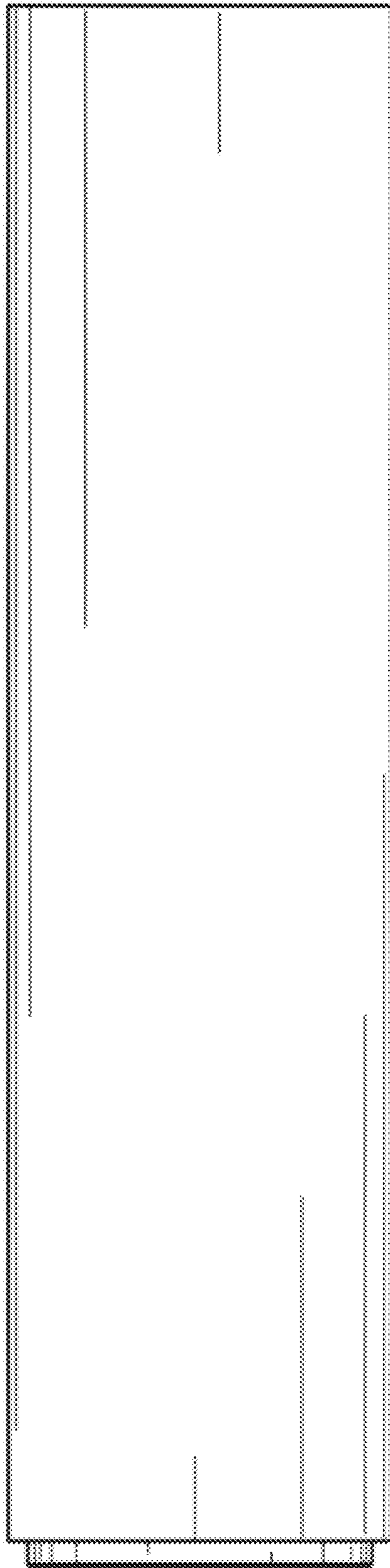

3.4

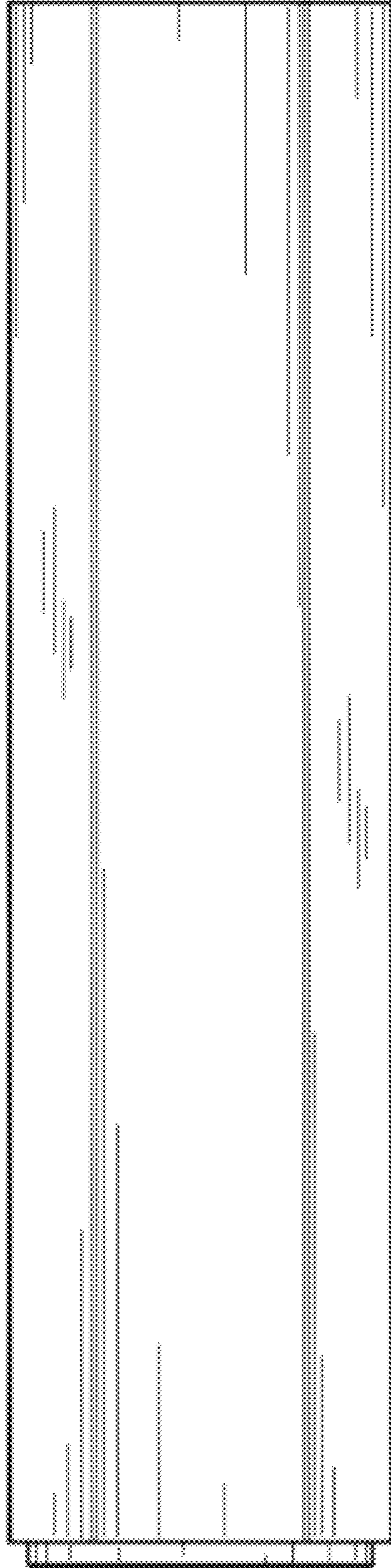

3.5

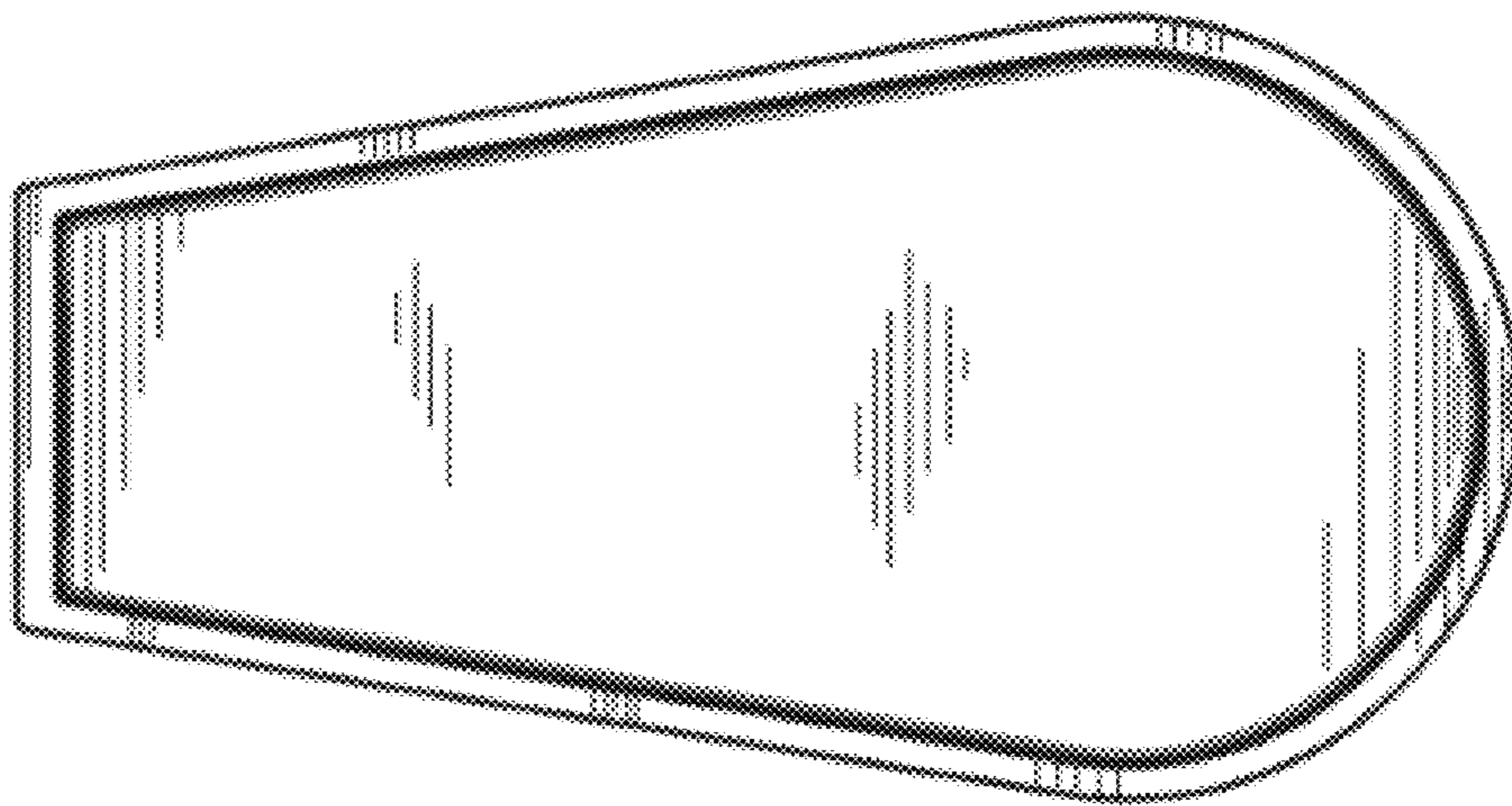

3.6

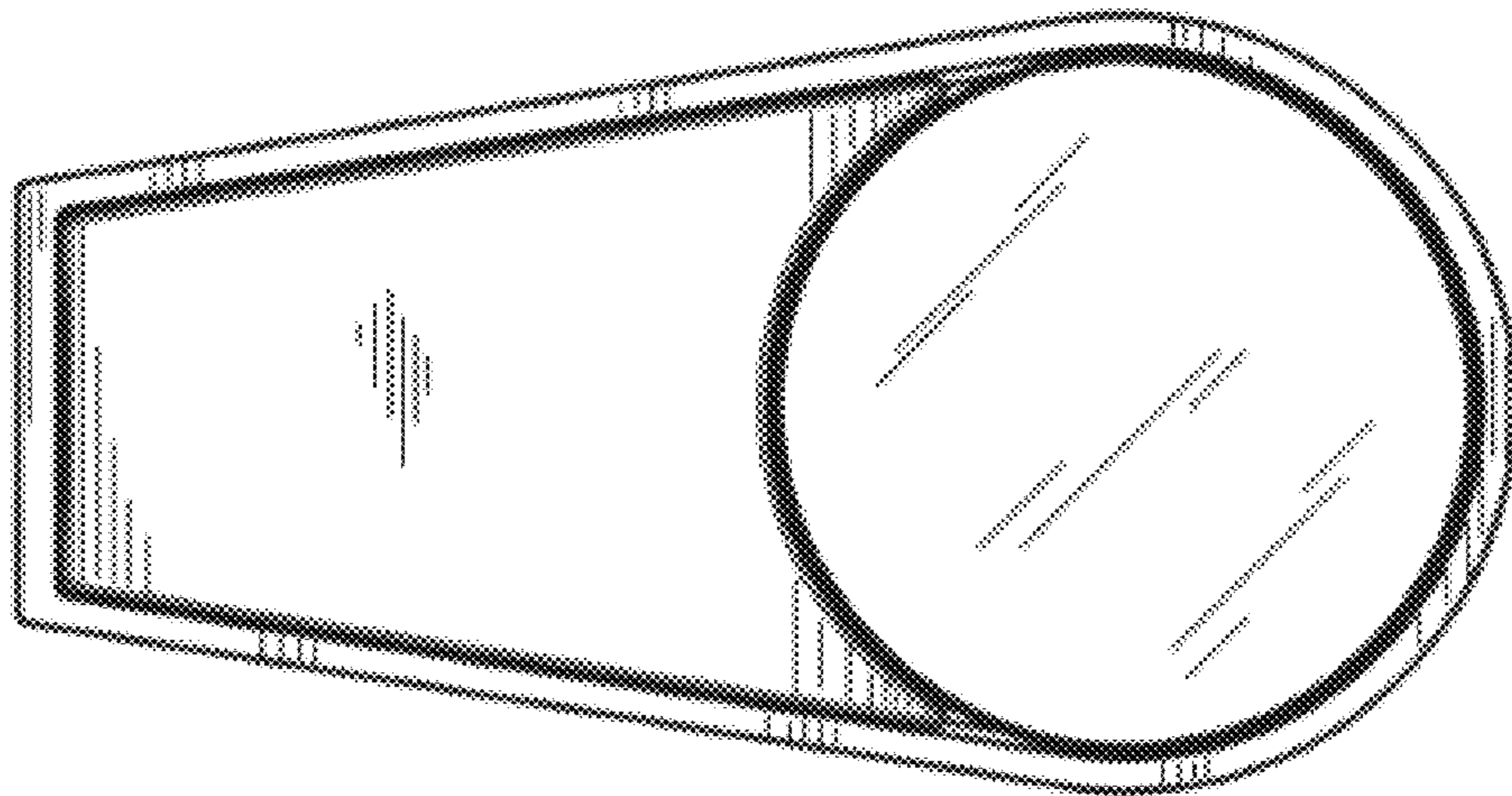

4.1

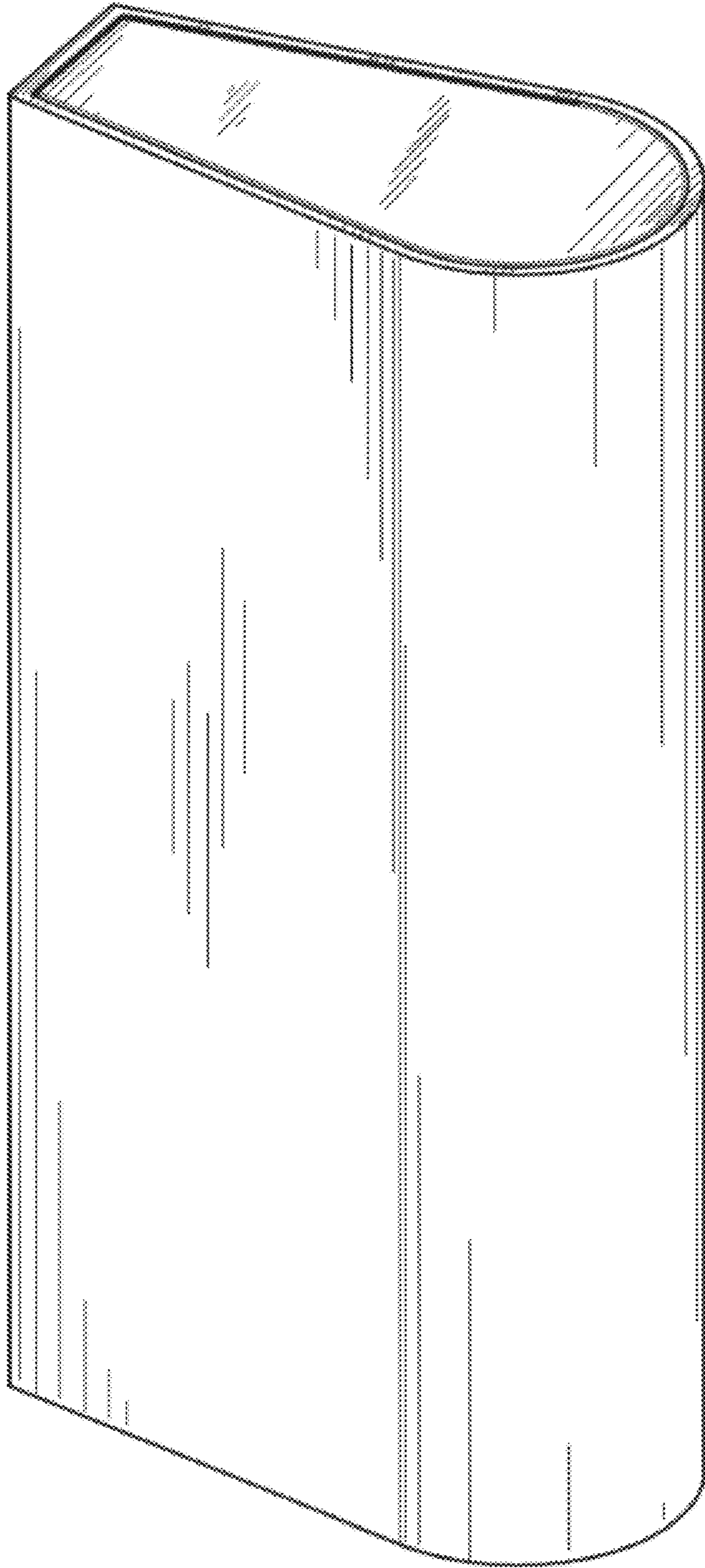

4.2

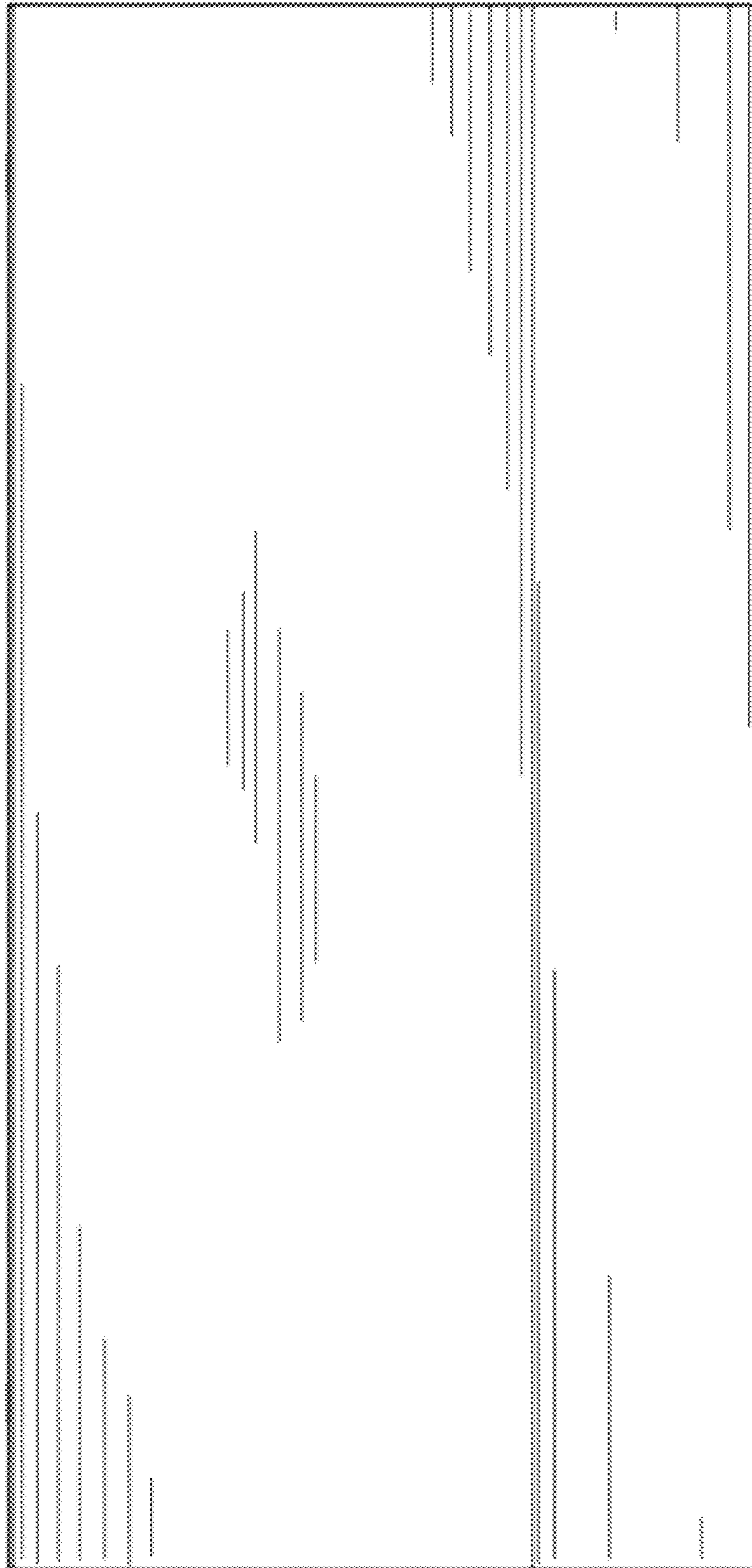

4.3

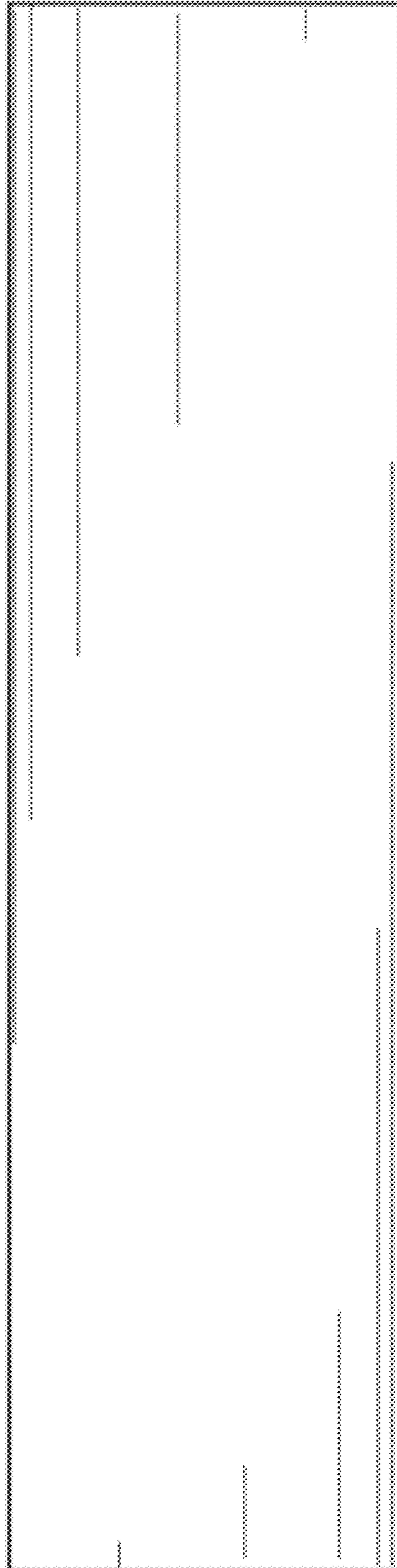

4.4

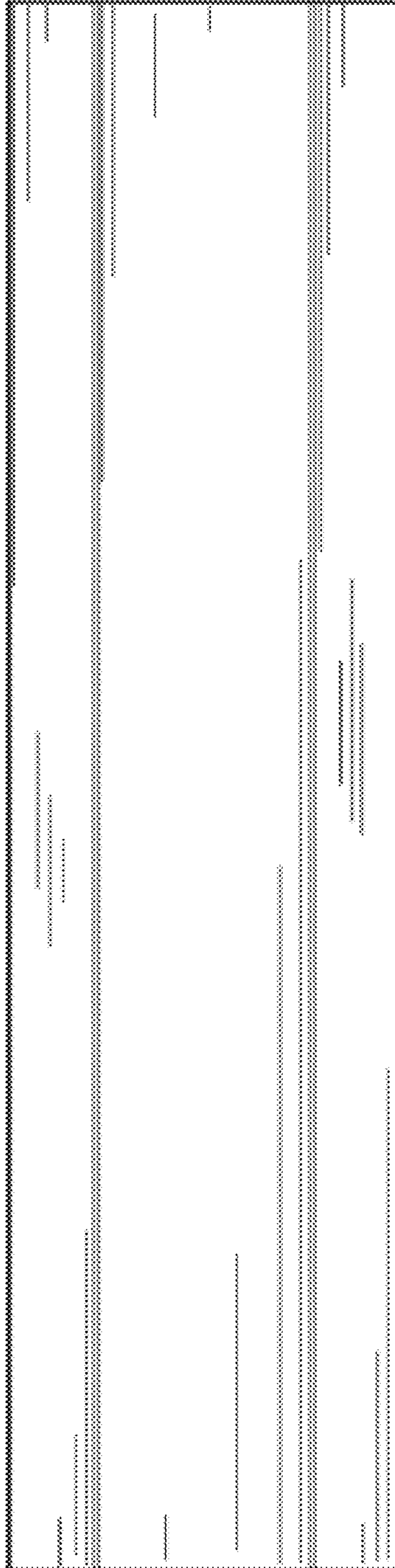

4.5

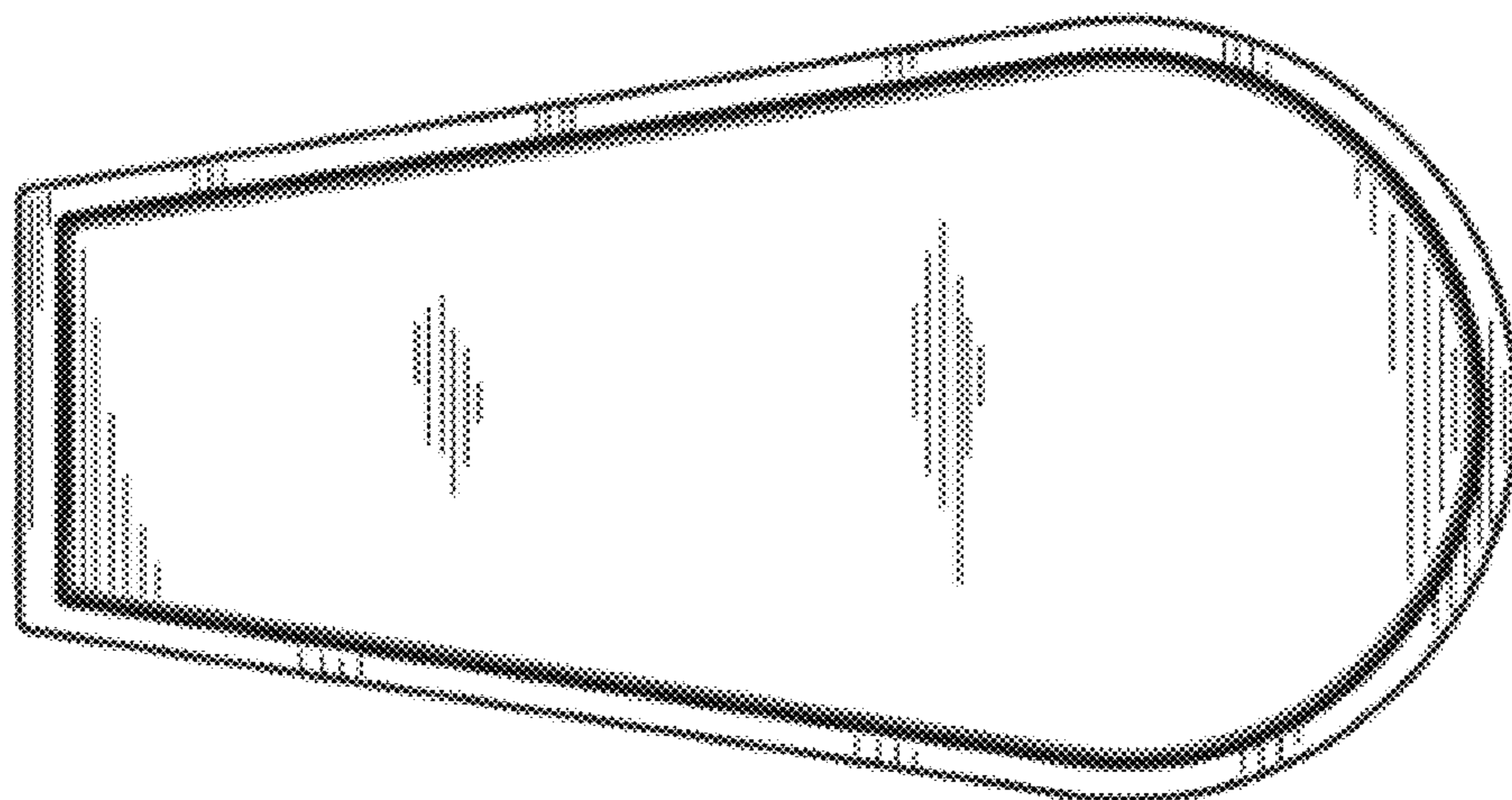

4.6

