



US00D828477S

(12) **United States Design Patent** (10) **Patent No.:** **US D828,477 S**
Warburton (45) **Date of Patent:** **** Sep. 11, 2018**

(54) **CHAMBER SAFETY FLAG FOR A FIREARM**

(71) Applicant: **Sturm, Ruger & Company, Inc.**,
Southport, CT (US)

(72) Inventor: **Scott Warburton**, South Acworth, NH
(US)

(73) Assignee: **STURM, RUGER & COMPANY,
INC.**

(**) Term: **15 Years**

(21) Appl. No.: **29/589,211**

(22) Filed: **Dec. 29, 2016**

(51) **LOC (11) Cl.** **22-01**

(52) **U.S. Cl.**
USPC **D22/108**

(58) **Field of Classification Search**
USPC D22/108, 109, 199; 42/108, 1.05, 44, 66,
42/70.01-70.11, 70.02, 70.06, 70.07, 150;
70/58, 63, 202, 211, 312; D24/141, 214,
D24/215; D30/160; D8/25, 40, 33, 197,
D8/107, 177.1, 177.85, 121.1, 124.3,
D8/165-170, 110.1, 176.2, 124.6, 176.1,
D8/176.15, 177.2, 186, 467, 476, 478,
D8/480
CPC .. F41A 9/00; F41A 17/42; F41A 17/02; F41A
17/44

See application file for complete search history.

(56) **References Cited**

U.S. PATENT DOCUMENTS

D235,030 S * 4/1975 Ziff D21/402
4,835,894 A 6/1989 Libassi
D306,627 S * 3/1990 Fox D21/718
5,410,832 A 5/1995 Barnhart
6,250,008 B1 6/2001 Silver
6,470,615 B1 10/2002 Peterken
6,526,684 B1 3/2003 Hickerson
D485,584 S * 1/2004 Lovullo D21/402

6,789,341 B1 9/2004 Badura
6,796,072 B2 9/2004 Barber et al.
6,871,438 B2 3/2005 Lawless
7,140,139 B2 11/2006 Markbreit et al.
7,146,761 B2 12/2006 Milo
D536,395 S * 2/2007 Buzzelli D21/402
D572,771 S * 7/2008 Styles D21/402

(Continued)

FOREIGN PATENT DOCUMENTS

EP 2365272 9/2011
FR 2938325 5/2010
NO 321710 4/2005

OTHER PUBLICATIONS

Kleen-Bore Chamber Safety Flags, MidwayUSA.com, [online],
[site visited Apr. 4, 2018]. <URL: <https://www.midwayusa.com/product/1015153369/kleen-bore-chamber-safety-flags-9mm-to-45-caliber-pistol-nylon-orange-pack-of-2>> (Year: 2018).*

(Continued)

Primary Examiner — T. Chase Nelson
Assistant Examiner — Jonathan J. Han
(74) *Attorney, Agent, or Firm* — The Belles Group, P.C.

(57) **CLAIM**

The ornamental design of a chamber safety flag for a
firearm, as shown and described.

DESCRIPTION

FIG. 1 is a right side perspective view of a chamber safety
flag for a firearm according to the new design;
FIG. 2 is a left side perspective view thereof;
FIG. 3 is a bottom view thereof;
FIG. 4 is a top view thereof;
FIG. 5 is a rear view thereof;
FIG. 6 is a front side view thereof;
FIG. 7 is a right side elevation view thereof; and,
FIG. 8 is a left side elevation view thereof.

1 Claim, 4 Drawing Sheets

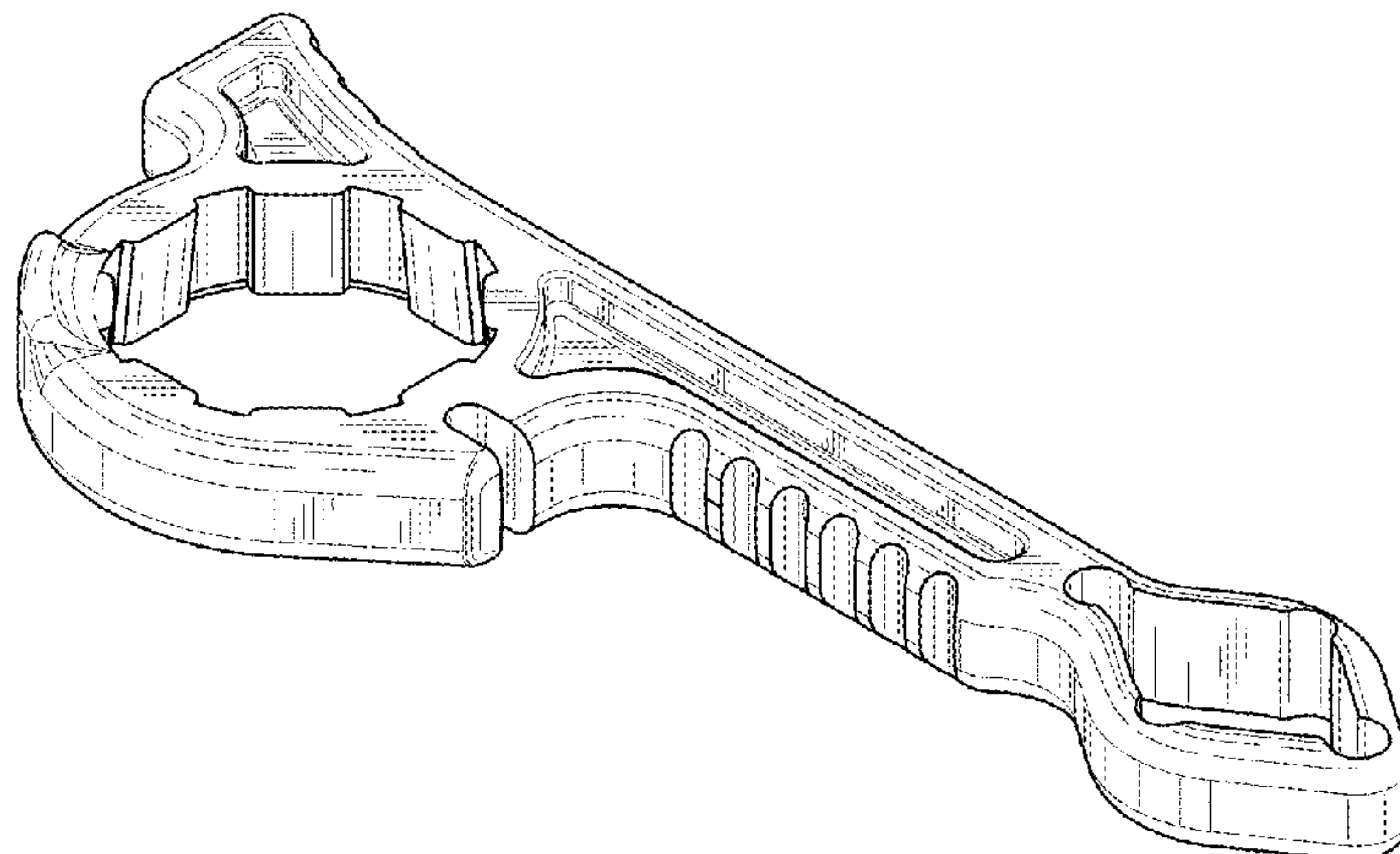

(56)

References Cited

U.S. PATENT DOCUMENTS

D589,094 S * 3/2009 Thai D21/402
 7,526,888 B1 5/2009 Joyce
 D624,648 S * 9/2010 Terry D24/135
 D631,123 S * 1/2011 Byers D22/108
 7,886,472 B2 2/2011 Chudwin
 7,891,129 B2 2/2011 Parry, Jr. et al.
 8,028,454 B1 10/2011 Pontillo, II
 D684,447 S * 6/2013 Huang D8/25
 8,650,790 B2 2/2014 Dionne et al.
 D701,282 S 3/2014 Ferguson, II et al.
 8,850,738 B2 10/2014 Silver
 8,857,092 B2 10/2014 Bitsack
 8,943,866 B2 2/2015 Fernandez et al.
 D736,919 S * 8/2015 Connolly D24/141
 D737,643 S * 9/2015 Foltyn D8/22
 D748,443 S * 2/2016 Ou D8/25
 9,448,024 B1 9/2016 Masters
 D773,657 S * 12/2016 Meloff D24/128
 D808,744 S * 1/2018 Hammi D7/653
 D814,031 S * 3/2018 Radpour D24/141
 2003/0172572 A1 9/2003 Clark
 2005/0059314 A1 * 3/2005 Lin A63H 33/28
 446/16

2009/0229159 A1 9/2009 Roth et al.
 2011/0119980 A1 5/2011 Rush
 2014/0024282 A1 * 1/2014 Lin A63H 33/28
 446/15
 2014/0273709 A1 * 9/2014 Cripe A63H 33/28
 446/16
 2016/0178309 A1 6/2016 Drake
 2016/0282072 A1 9/2016 Adamietz
 2017/0356711 A1 * 12/2017 Lessard F41A 17/44

OTHER PUBLICATIONS

Leapers UTG Universal Firearm Chamber Safety Flags, CheaperThanDirt.com, [online], [site visited Apr. 4, 2018]. <URL: <https://www.cheaperthandirt.com/product/part-number-gns-011-4712274529694.do>> (Year: 2018).*

Arredondo Multi-Gun Chamber Flags, DillonPrecision.com, [online], [site visited Apr. 4, 2018]. <URL: https://www.dillonprecision.com/arredondo-multi-gun-chamber-flags_8_20_25599.html> (Year: 2018).*

Tapco Shotgun Chamber Safety Flag Tool, MidwayUSA.com, [online], [site visited Apr. 4, 2018]. <URL: <https://www.midwayusa.com/product/534124/tapco-shotgun-chamber-safety-flag-tool-package-of-6>> (Year: 2018).*

* cited by examiner

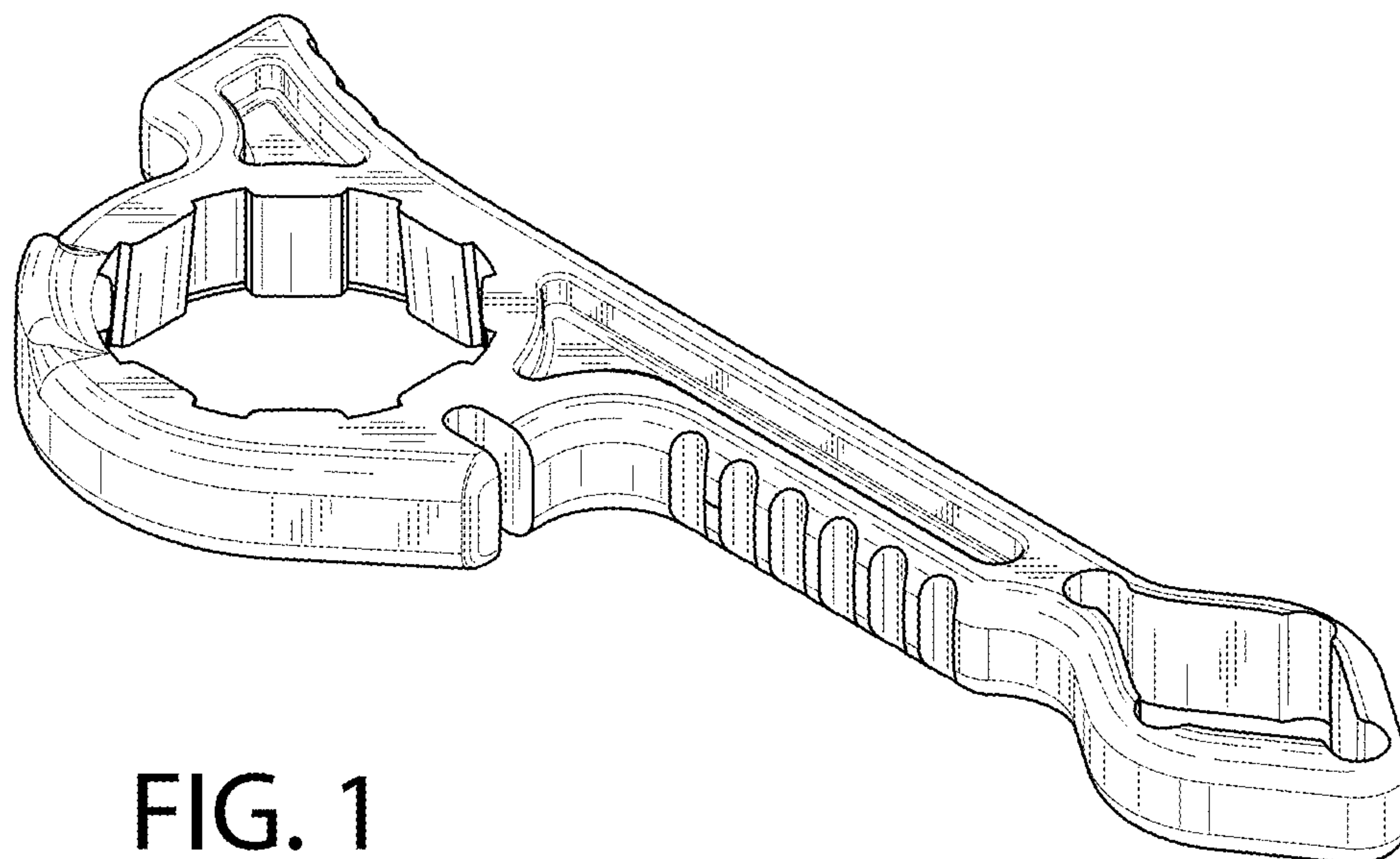

FIG. 1

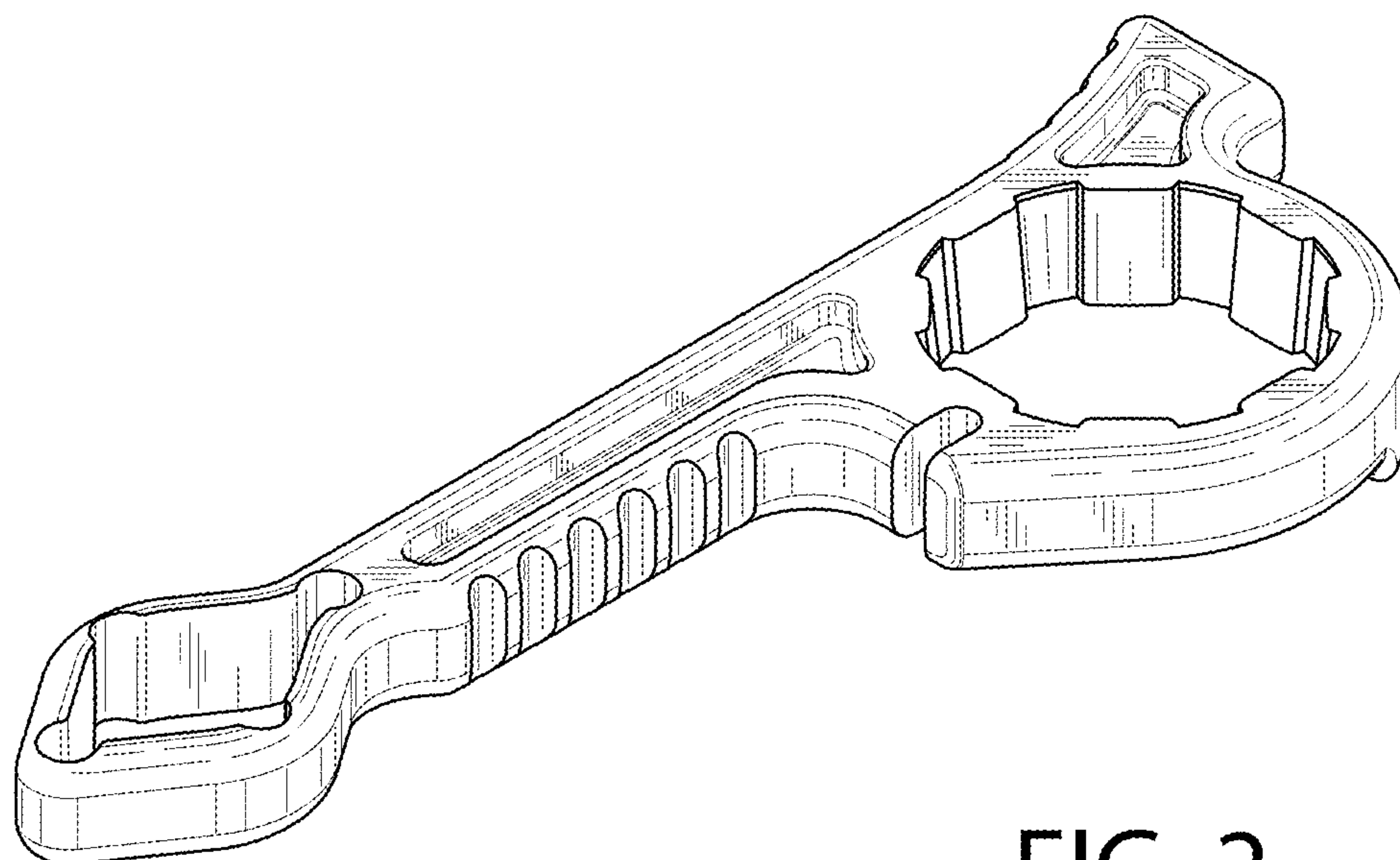

FIG. 2

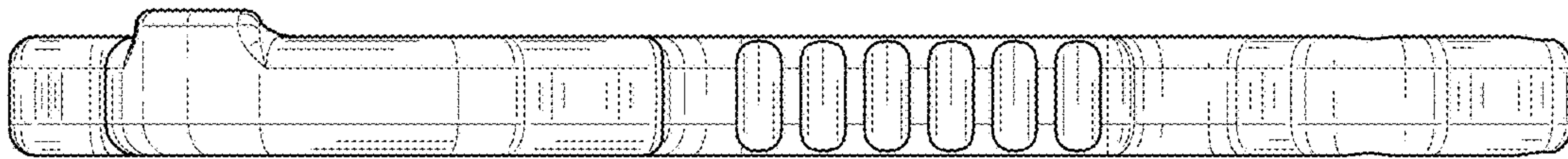

FIG. 3

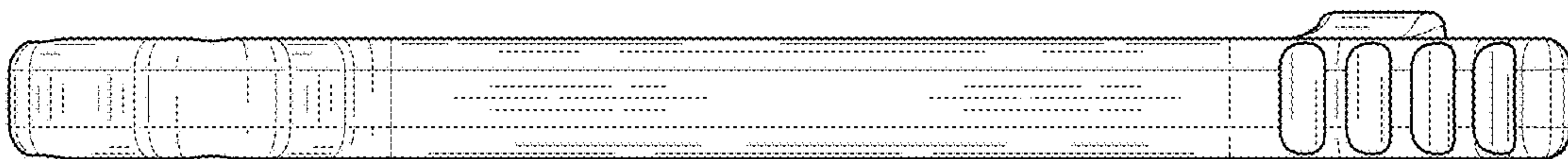

FIG. 4

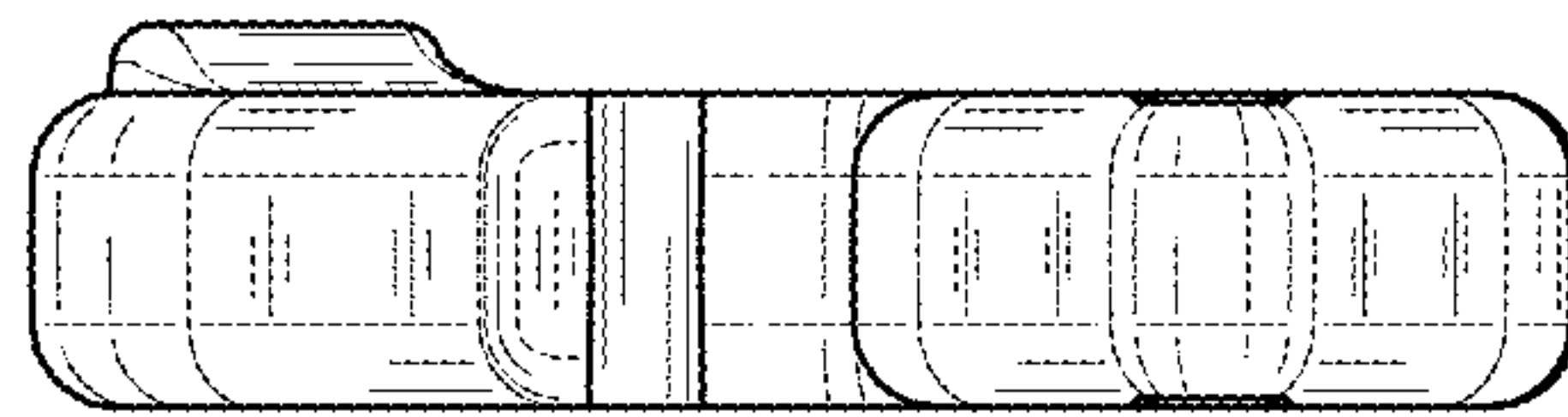

FIG. 5

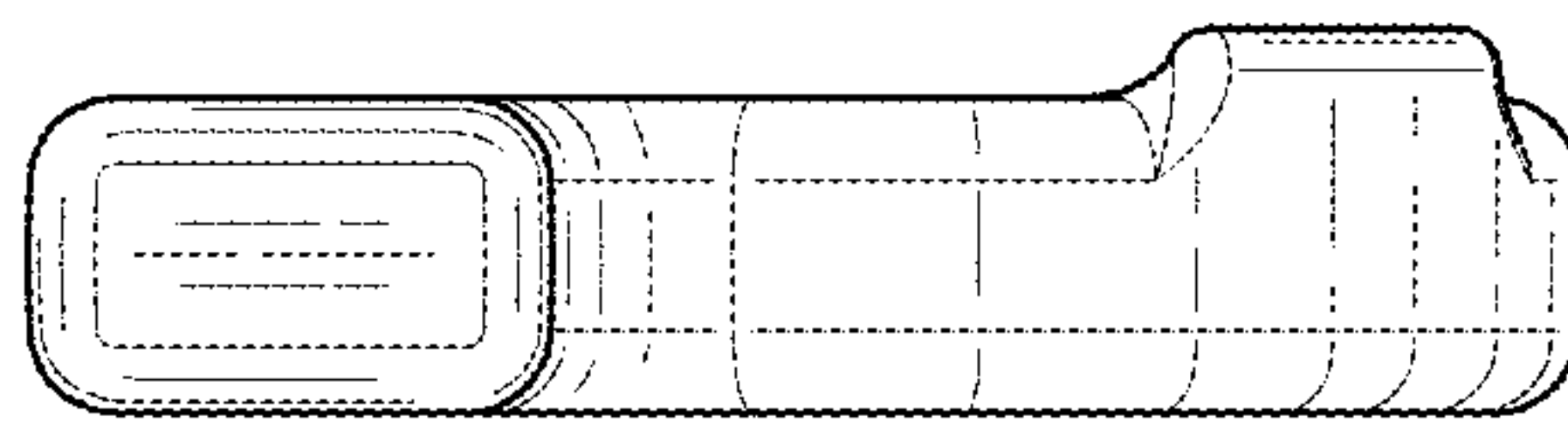

FIG. 6

