



US00D828446S

(12) **United States Design Patent**
Kim

(10) **Patent No.:** **US D828,446 S**

(45) **Date of Patent:** **** Sep. 11, 2018**

(54) **BOOK STAND**

(71) Applicant: **Min Yang Kim**, Yongin-si (KR)

(72) Inventor: **Min Yang Kim**, Yongin-si (KR)

(73) Assignee: **Min Yang Kim**, Yongin (KR)

(**) Term: **15 Years**

(21) Appl. No.: **29/599,561**

(22) Filed: **Apr. 4, 2017**

(51) **LOC (11) Cl.** **19-02**

(52) **U.S. Cl.**
USPC **D19/91**

(58) **Field of Classification Search**
USPC D19/75, 76, 77, 78, 84, 85, 86, 89, 90,
D19/91, 92; D3/206, 227, 299, 315;
D6/634, 675.1; D9/734
CPC .. B43M 99/00; B43M 99/001; B43M 99/003;
B43M 99/006; B43M 99/008; B42D
5/005; B42D 5/008
See application file for complete search history.

D250,855 S * 1/1979 Gotz 281/30
4,709,895 A * 12/1987 Mardak A47B 23/044
248/459
4,981,732 A * 1/1991 Hoberman A63H 33/16
428/12
D315,366 S * 3/1991 Greenspahn D19/113
D403,914 S * 1/1999 Man D19/90
6,054,194 A * 4/2000 Kane B60D 5/003
105/18
D442,392 S * 5/2001 Follman D19/86
6,397,653 B1 * 6/2002 Kane B60D 5/003
72/299
6,601,598 B2 * 8/2003 Clee A01G 9/16
135/143
D663,777 S * 7/2012 Lira-Nunez D19/85

* cited by examiner

Primary Examiner — Elizabeth Albert

(74) *Attorney, Agent, or Firm* — Lewis Brisbois Bisgaard & Smith LLP

(57) **CLAIM**

The ornamental design for a book stand, as shown and described.

(56) **References Cited**

U.S. PATENT DOCUMENTS

2,224,530 A * 12/1940 Weinstein A47B 23/043
211/43
3,013,668 A * 12/1961 Mennen A47F 5/112
211/195
3,410,516 A * 11/1968 Criswell A47B 23/04
248/459
3,854,266 A * 12/1974 Salas E04B 1/34378
52/18
3,967,023 A * 6/1976 Lysek B23Q 11/0816
193/35 C
4,073,460 A * 2/1978 Dale B43M 99/00
248/174

DESCRIPTION

FIG. 1 is a perspective view of the book stand showing my new design;
FIG. 2 is a front elevation view thereof;
FIG. 3 is a back elevation view thereof;
FIG. 4 is a right side elevation view thereof;
FIG. 5 is a left side elevation view thereof;
FIG. 6 is a top plan view thereof;
FIG. 7 is a bottom plan view thereof; and,
FIG. 8 is a perspective view of the book stand in a compressed configuration.

1 Claim, 4 Drawing Sheets

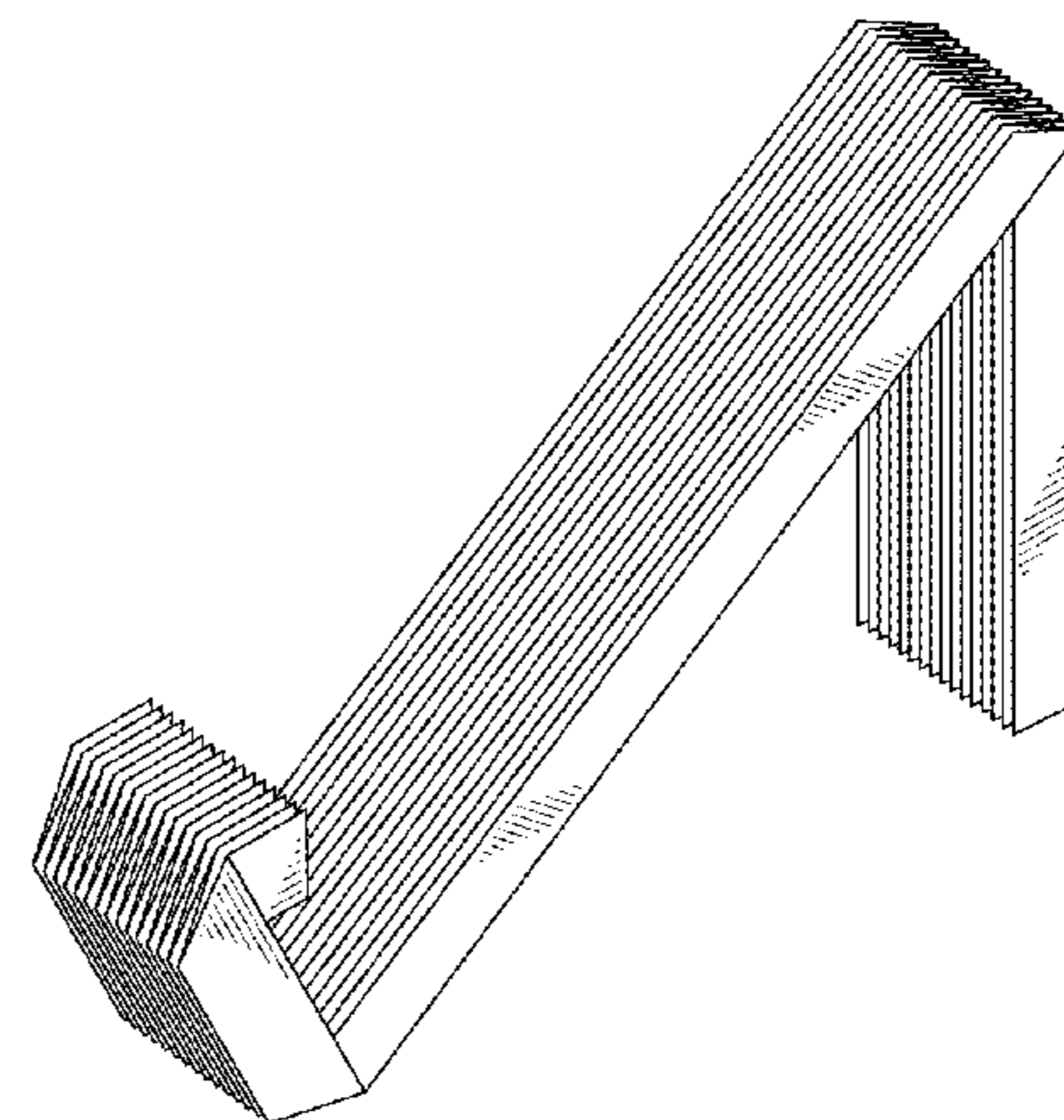
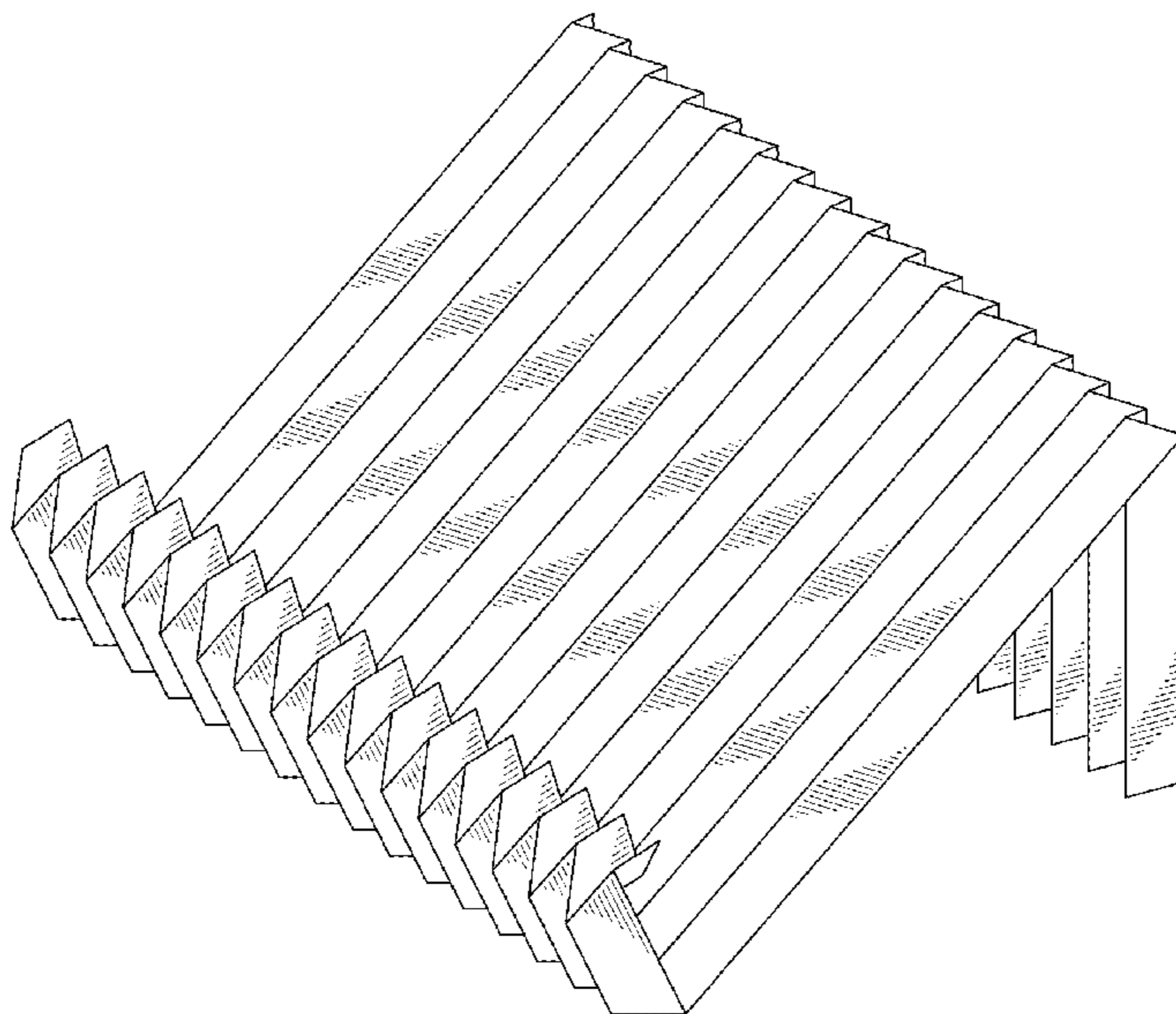

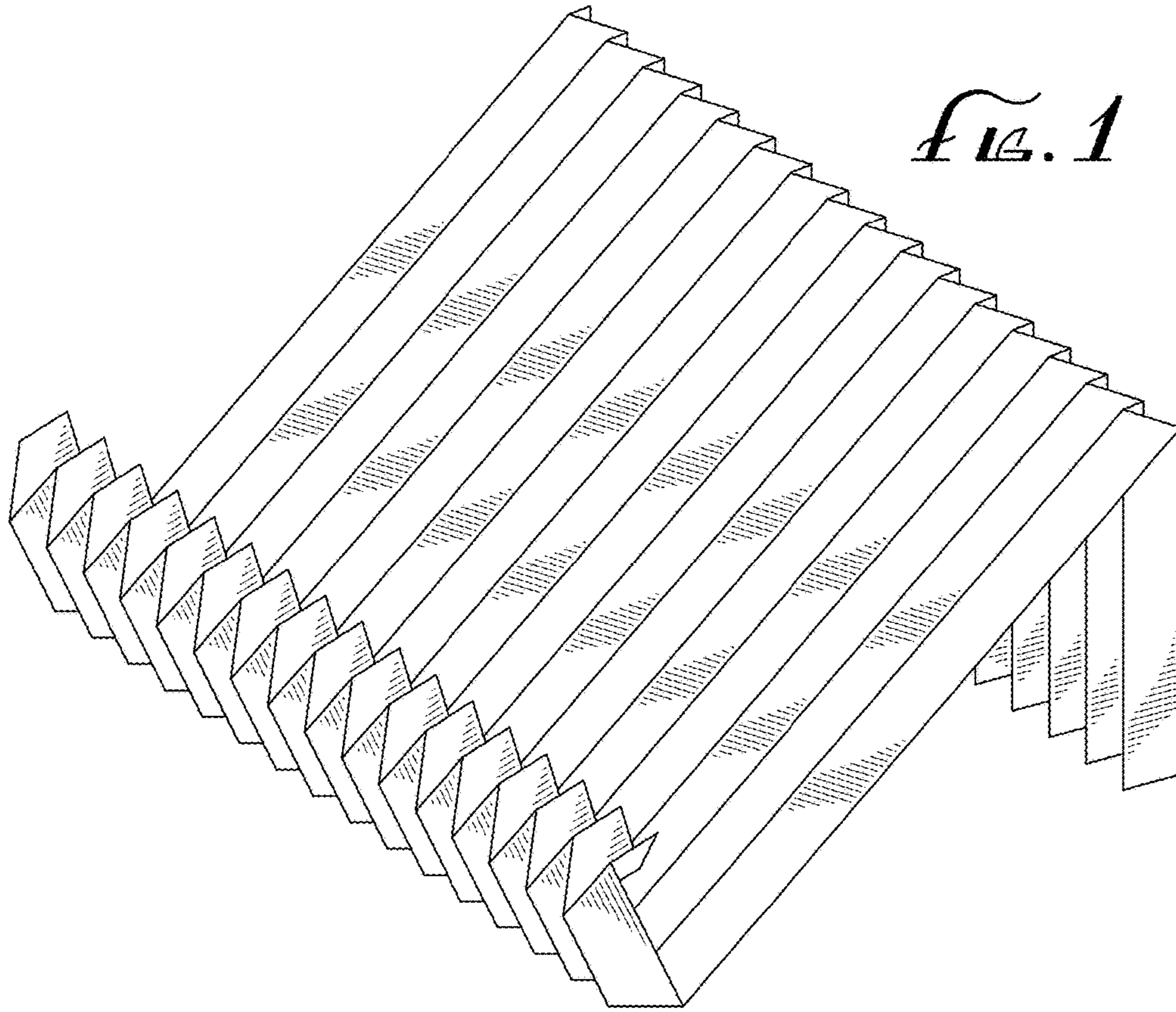

FIG. 1

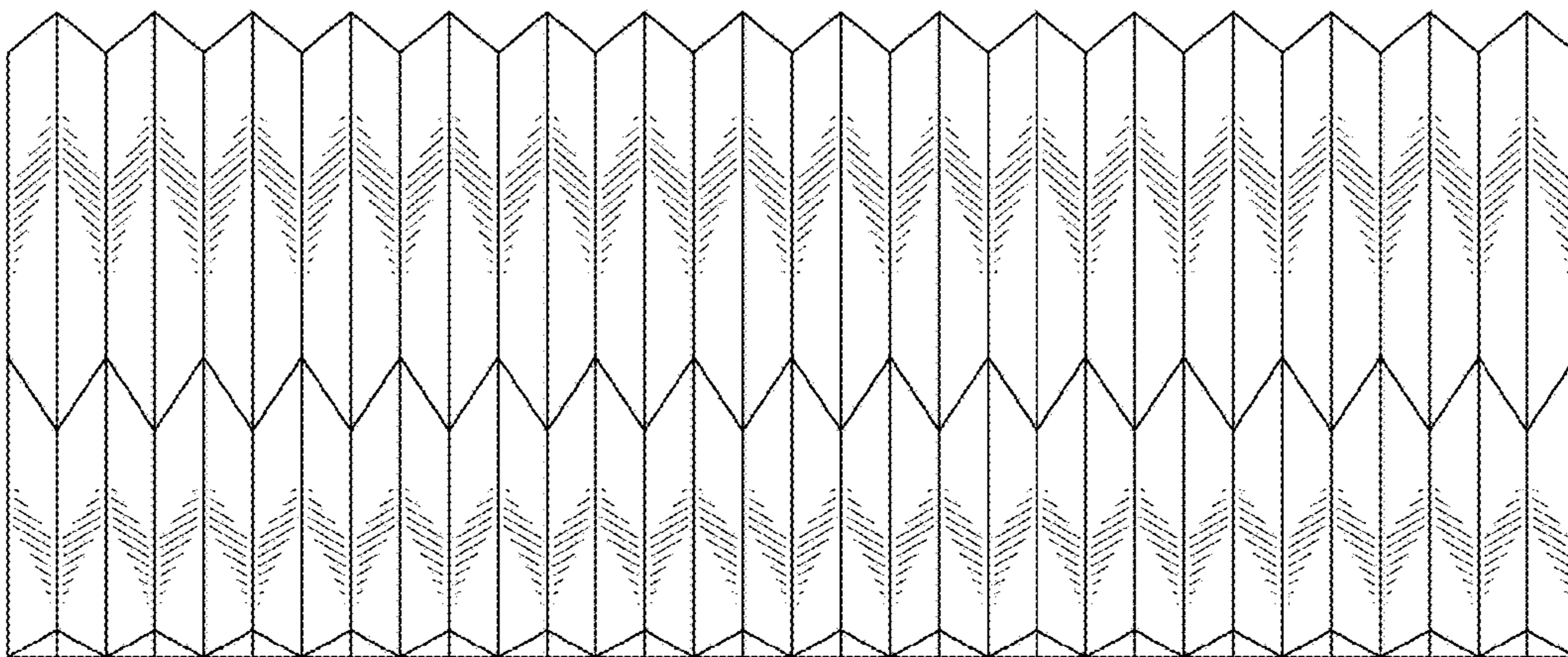

FIG. 2

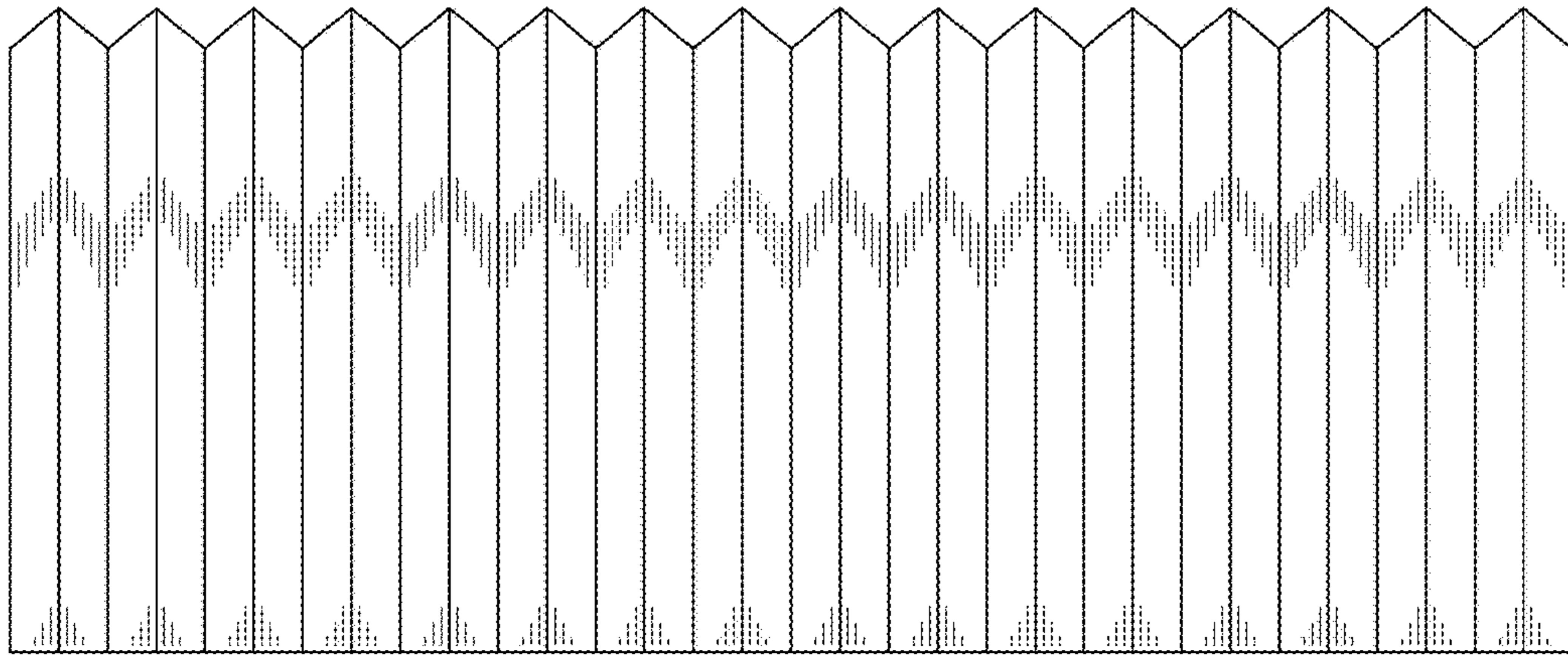

FIG. 3

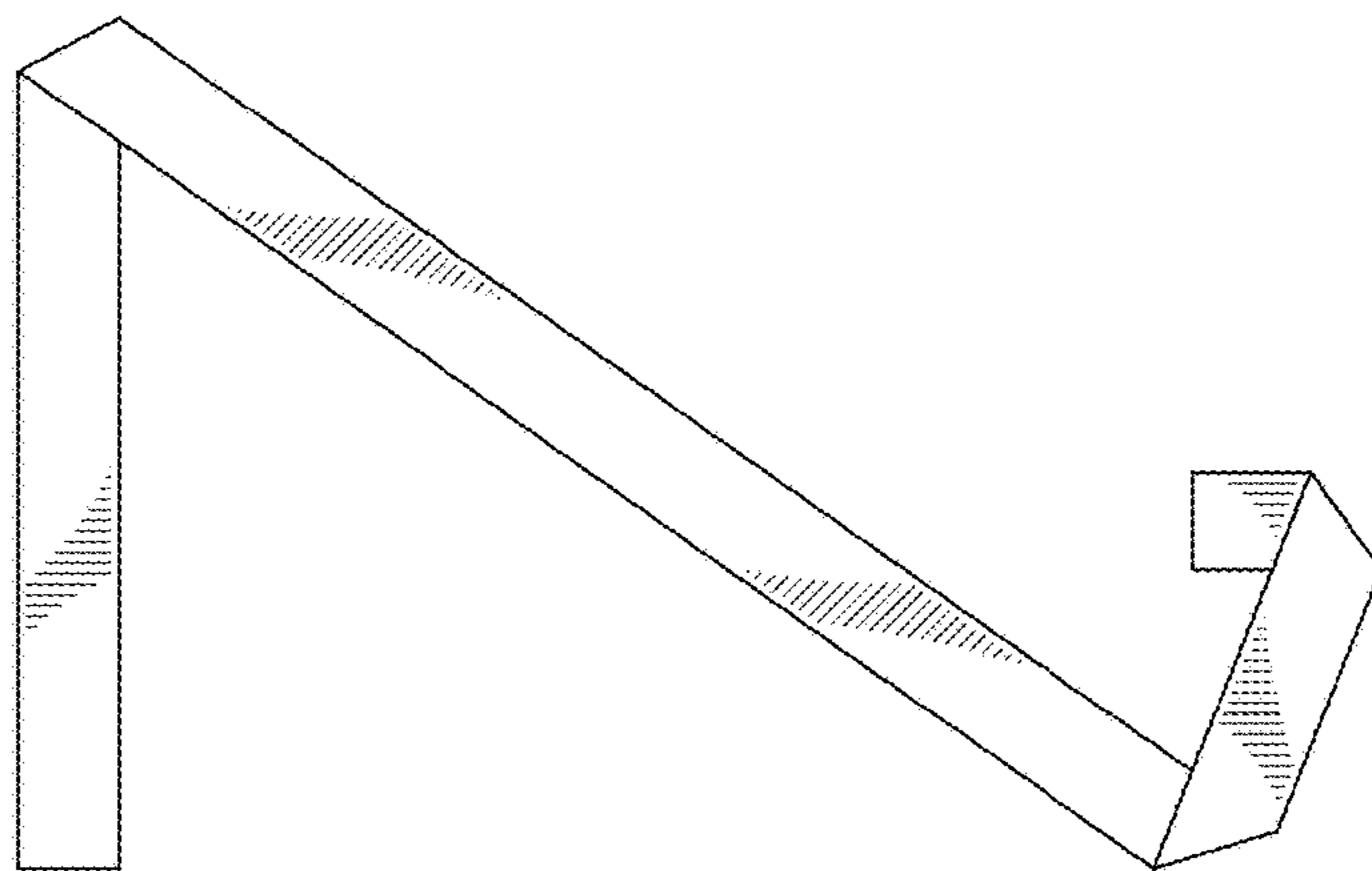

FIG. 4

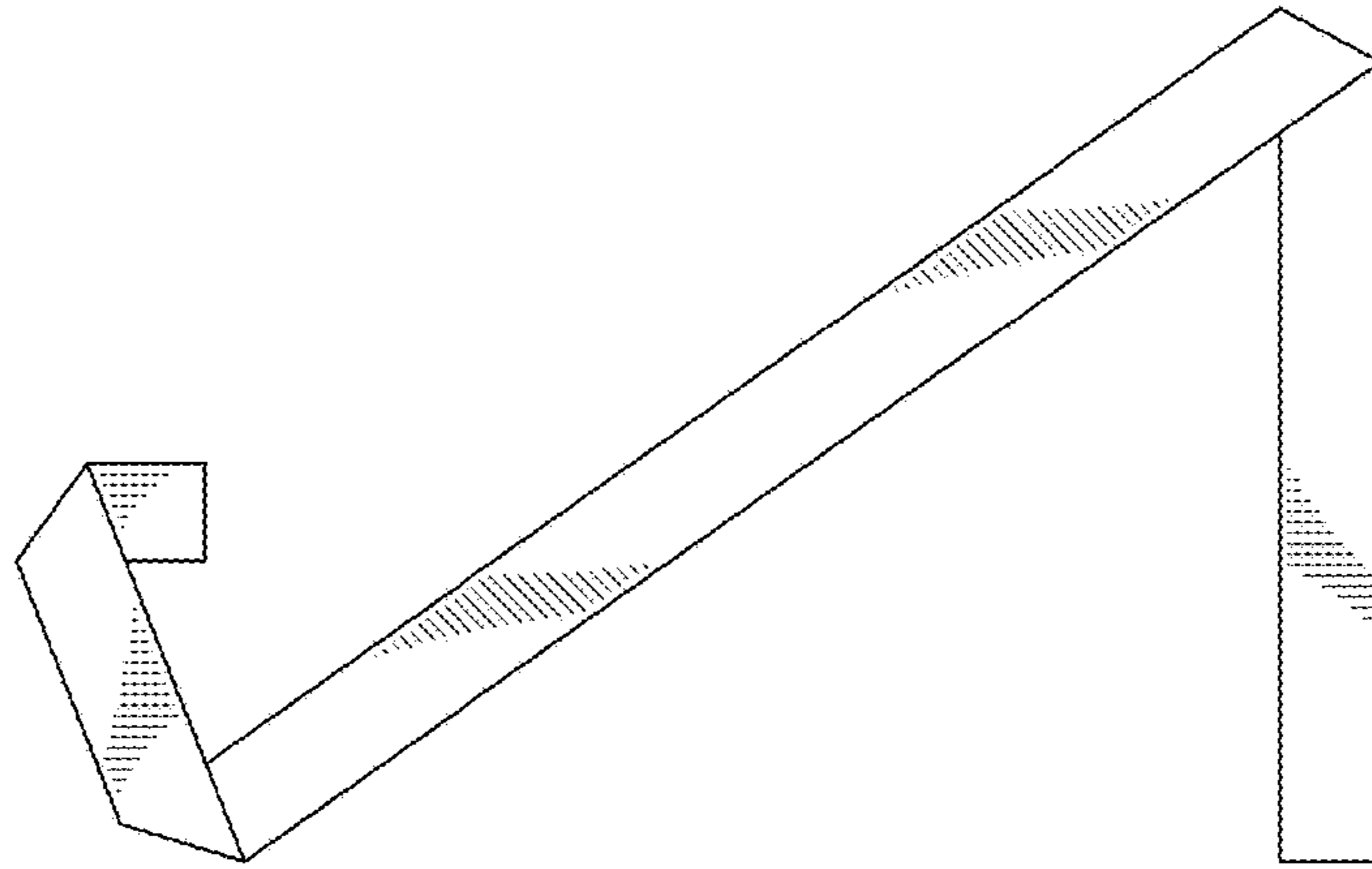

FIG. 5

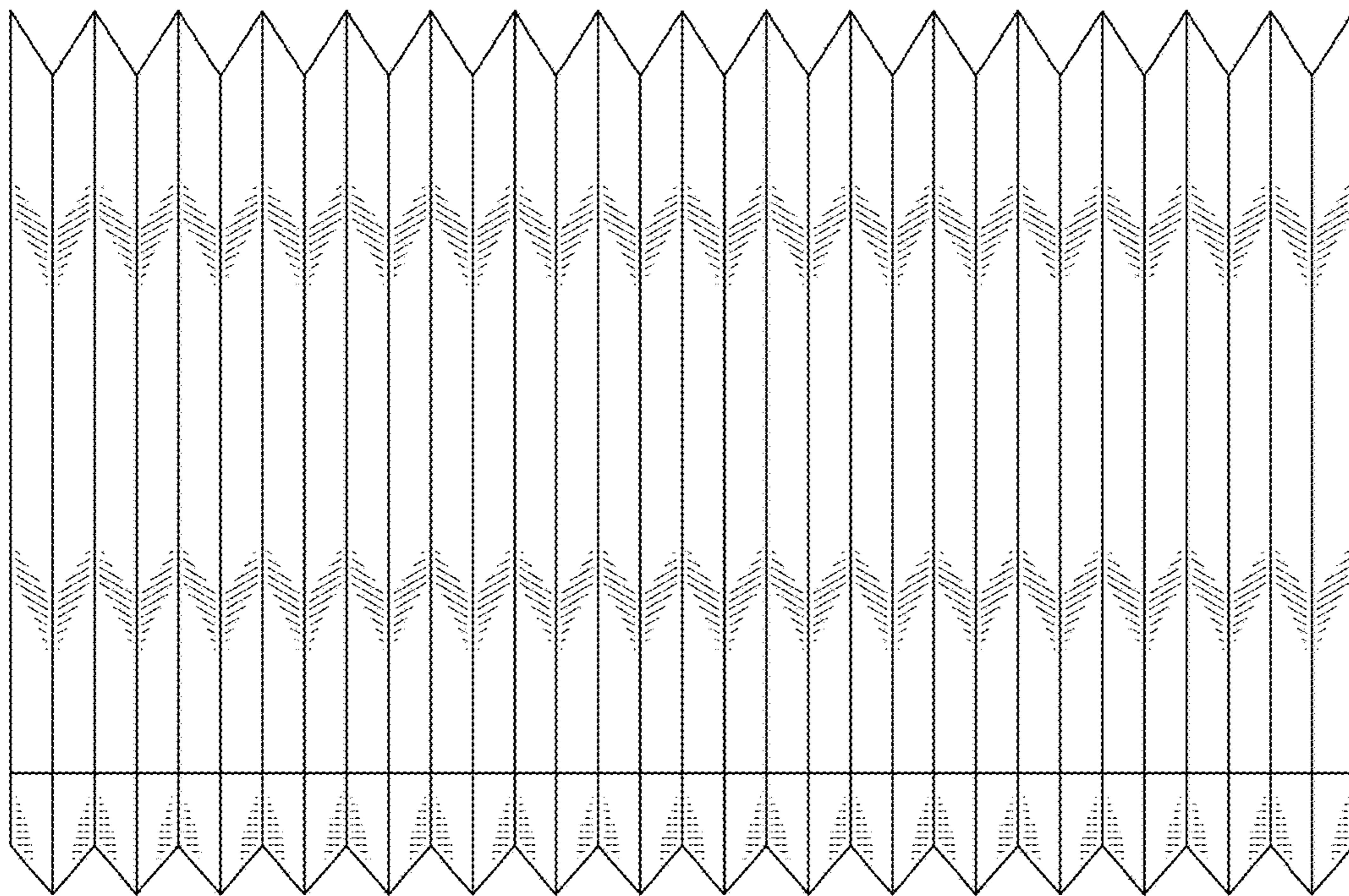

FIG. 6

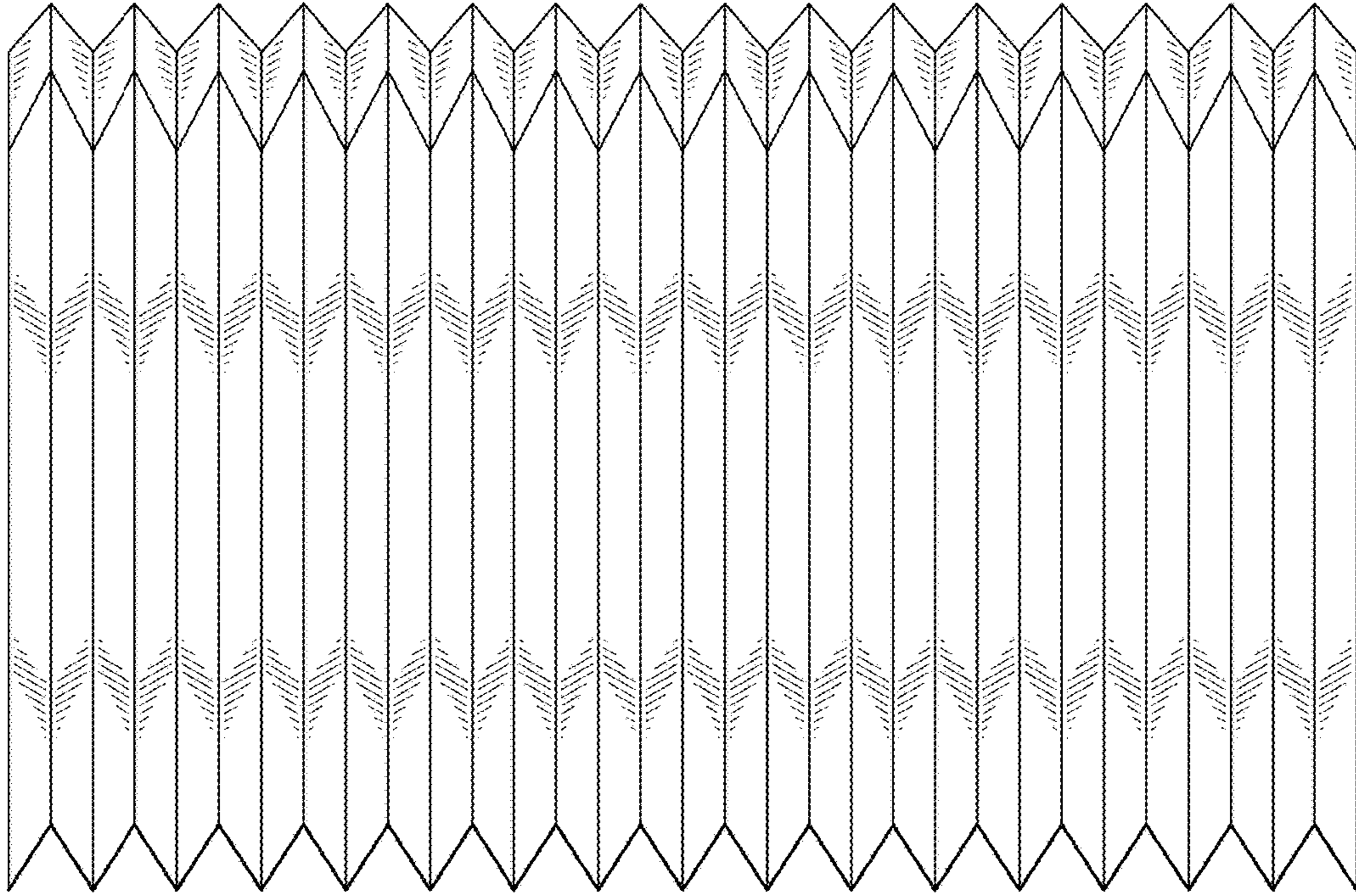

FIG. 7

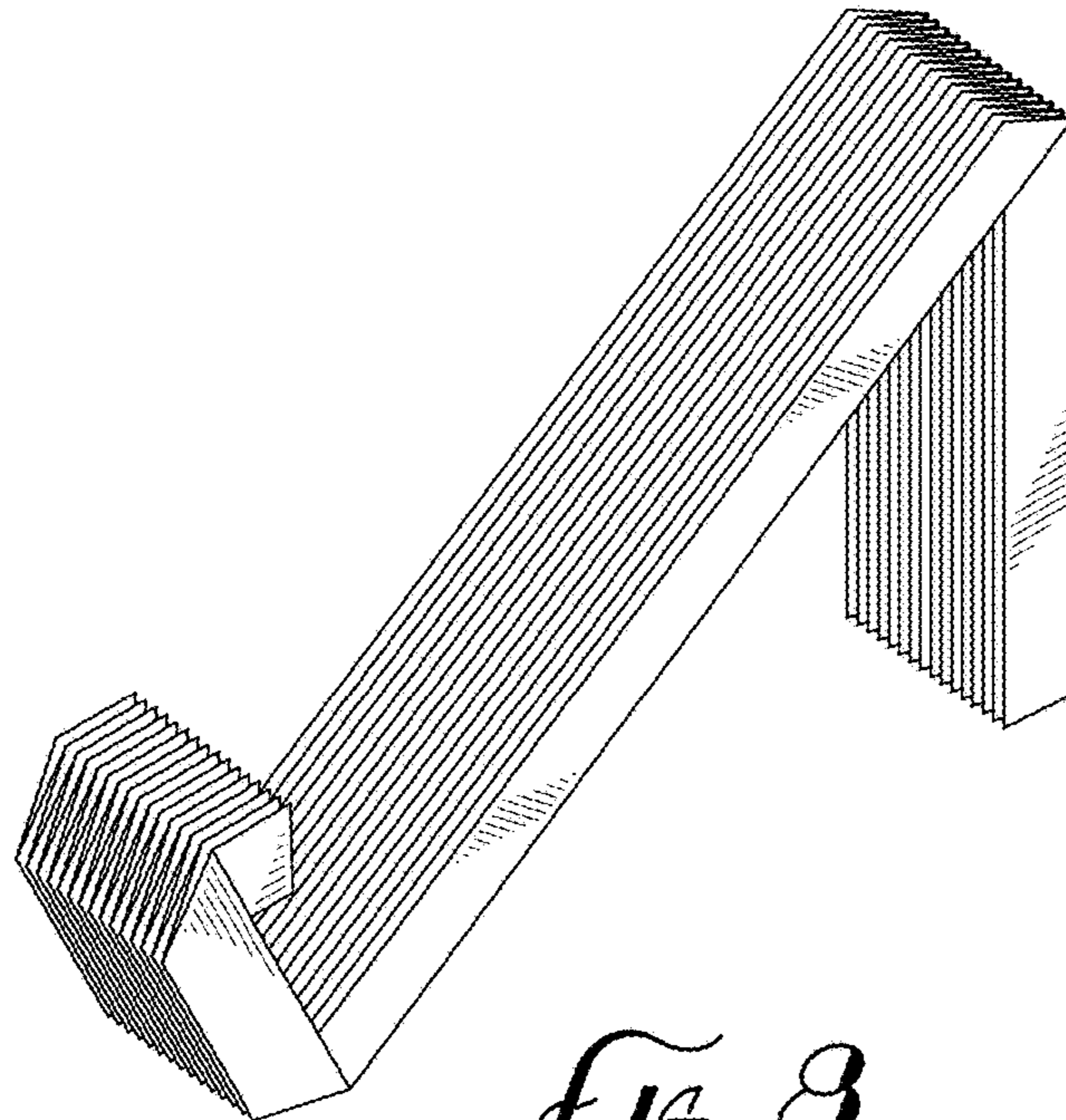

FIG. 8