



US00D828333S

(12) **United States Design Patent** (10) **Patent No.:** **US D828,333 S**  
**Hu** (45) **Date of Patent:** **\*\* Sep. 11, 2018**

(54) **SPEAKER**  
(71) Applicant: **VTIN TECHNOLOGY CO., LIMITED**, Hong Kong (HK)  
(72) Inventor: **Zaihui Hu**, Shenzhen (CN)  
(73) Assignee: **VTIN TECHNOLOGY CO., LIMITED**, Hong Kong (HK)  
(\*\*) Term: **15 Years**  
(21) Appl. No.: **29/647,816**  
(22) Filed: **May 16, 2018**  
(51) **LOC (11) Cl.** ..... **14-01**  
(52) **U.S. Cl.**  
USPC ..... **D14/216**  
(58) **Field of Classification Search**  
USPC ... D14/216, 215, 204, 209.1, 217, 218, 219, D14/171, 194, 192, 196, 198, 167, 188, D14/137, 165, 163, 168, 509, 510, 159, D14/149, 226, 225; D3/208; D21/516; D23/229; D10/104.1, 106; 181/188, 189, 181/192-198; 379/430, 431, 444; 381/353, 355; 455/90.1, 350, 351, 344, 455/347  
CPC ... H05K 5/00; H04R 1/10; H04R 1/02; H04R 1/20; H04R 25/00; H04R 1/08  
See application file for complete search history.

4,620,317 A \* 10/1986 Anderson ..... H04R 1/345  
181/155  
4,691,383 A \* 9/1987 DeMars ..... H04B 1/086  
379/430  
D295,173 S \* 4/1988 Oren ..... D14/168  
4,804,972 A \* 2/1989 Schudel ..... H01Q 1/42  
343/840  
D304,944 S \* 12/1989 Behringer ..... D14/188  
D306,588 S \* 3/1990 Kashiwagi ..... D14/163  
D314,574 S \* 2/1991 Kato ..... D14/163  
D317,768 S \* 6/1991 Davidson ..... D14/216  
D321,881 S \* 11/1991 Hopewell ..... D14/192  
D323,826 S \* 2/1992 Suzuki ..... D14/137  
D325,207 S \* 4/1992 Dix ..... D14/188  
D327,690 S \* 7/1992 Ogawa ..... D14/230  
D346,598 S \* 5/1994 McCay ..... D14/137

(Continued)

**FOREIGN PATENT DOCUMENTS**

CN 304566298 4/2018

*Primary Examiner* — Paula Allen Greene  
(74) *Attorney, Agent, or Firm* — JCIPRNET

(57) **CLAIM**

The ornamental design for a speaker, as shown and described.

**DESCRIPTION**

FIG. 1 is a perspective view of a speaker showing my new design;  
FIG. 2 is another perspective view thereof;  
FIG. 3 is a front view thereof;  
FIG. 4 is a rear view thereof;  
FIG. 5 is a left side view thereof;  
FIG. 6 is a right side view thereof;  
FIG. 7 is a top view thereof; and,  
FIG. 8 is a bottom view thereof.

The broken lines showing portions of the speaker represent unclaimed portions of the claimed design and form no part of the claimed design.

**1 Claim, 6 Drawing Sheets**

(56) **References Cited**

**U.S. PATENT DOCUMENTS**

2,890,297 A \* 6/1959 Lehr ..... H04R 1/08  
181/148  
D215,675 S \* 10/1969 Yian ..... D13/114  
D216,374 S \* 12/1969 Yran ..... D13/108  
D237,009 S \* 9/1975 Izuhara ..... D14/198  
3,965,544 A \* 6/1976 Boden ..... F16G 11/101  
24/115 M  
D274,619 S \* 7/1984 Glicher ..... D14/189

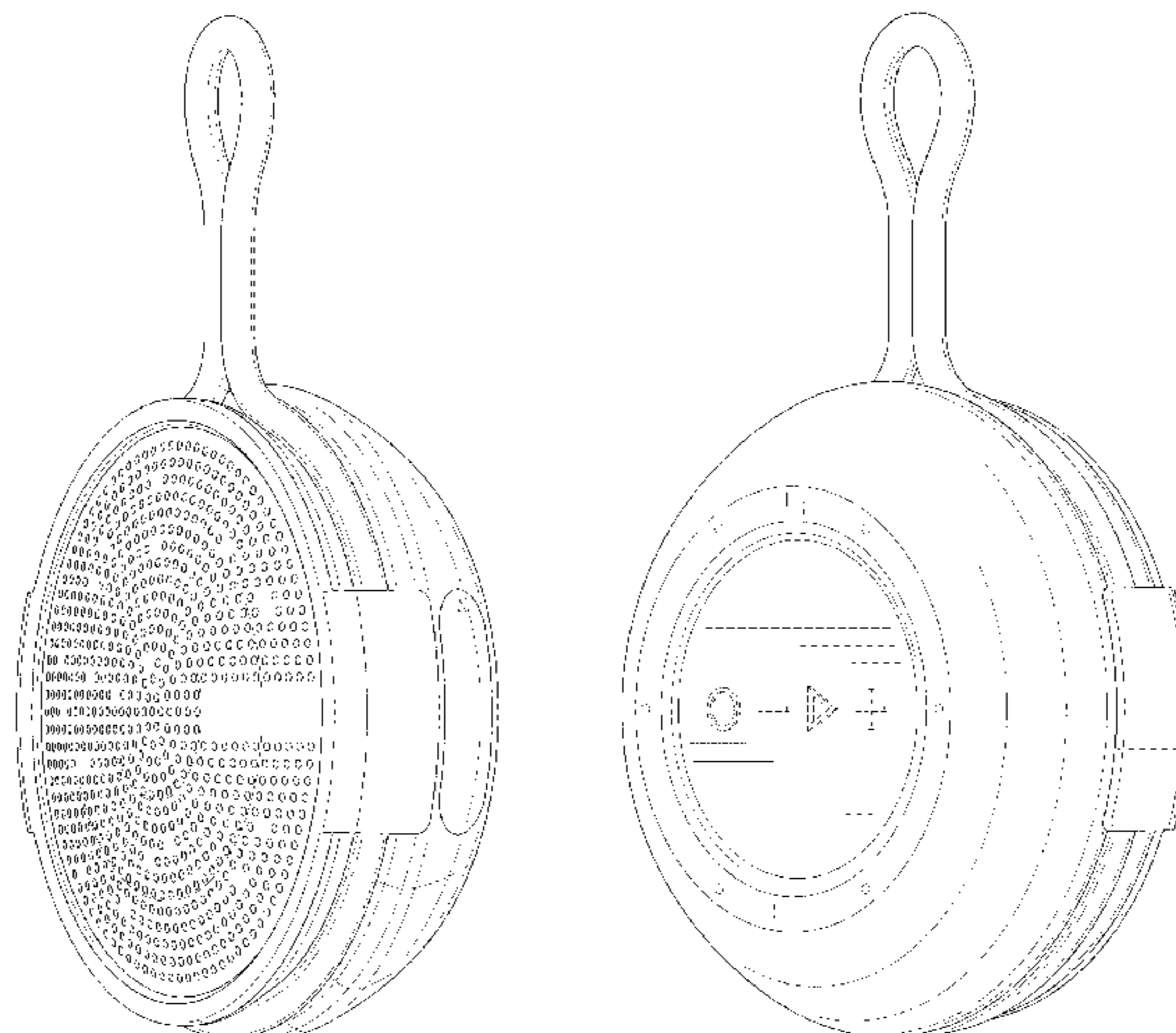

(56)

References Cited

U.S. PATENT DOCUMENTS

D358,149 S *	5/1995	Fellinger	D14/138 AB	D625,295 S *	10/2010	Nogueira	D14/218
D362,442 S *	9/1995	Goldfarb	D14/215	D632,262 S *	2/2011	Feldstein	D13/164
D383,983 S *	9/1997	Steinhagen	D10/22	D632,265 S *	2/2011	Choi	D13/168
D391,572 S *	3/1998	Lee	D14/192	D633,085 S *	2/2011	Chiu	D11/5
D415,159 S *	10/1999	Nakano	D14/215	D636,760 S *	4/2011	Cheng	D14/216
D417,452 S *	12/1999	Wu	D14/192	D643,022 S *	8/2011	Hou	D14/216
D434,403 S *	11/2000	Jaynes	D14/138 R	D643,412 S *	8/2011	Brady	D14/218
D450,049 S *	11/2001	Lacotta	D14/171	D643,414 S *	8/2011	Lee	D14/205
D465,469 S *	11/2002	Heath	D10/104.1	D645,818 S *	9/2011	Guccione	D13/108
6,728,518 B1 *	4/2004	Scrivens	H04B 1/086 455/347	D647,810 S *	11/2011	Bohrer	D10/106.9
D494,633 S *	8/2004	Nussberger	D21/324	D652,023 S *	1/2012	Chen	D14/216
D501,843 S *	2/2005	Oas	D14/188	D671,528 S *	11/2012	Fathollahi	D14/211
D502,694 S *	3/2005	Chang	D14/188	D682,805 S *	5/2013	Rath	D14/149
D511,157 S *	11/2005	Johnson	D14/223	D683,350 S *	5/2013	Jarosinski	D11/3
D512,406 S *	12/2005	Shimizu	D14/167	D726,158 S *	4/2015	Zhao	D14/216
D512,417 S *	12/2005	Hirakawa	D14/223	D726,687 S *	4/2015	Minarik	D14/192
D516,541 S *	3/2006	Bhavani	D14/192	D727,297 S *	4/2015	Valeur	D14/216
D518,030 S *	3/2006	Lin	D14/218	D730,872 S *	6/2015	Wan	D14/216
D526,642 S *	8/2006	Choe	D14/205	D732,006 S *	6/2015	Zhao	D14/216
D534,889 S *	1/2007	Cheng	D14/138 R	D733,889 S *	7/2015	Brandis	D24/174
D537,072 S *	2/2007	Kim	D14/215	D737,249 S *	8/2015	Zhao	D14/216
D542,280 S *	5/2007	Taylor	D14/218	D740,258 S *	10/2015	Yu	D14/216
D550,204 S *	9/2007	Kaneda	D14/216	D749,666 S *	2/2016	Ahdoot	D14/218
D554,614 S *	11/2007	Lin	D14/509	D752,024 S *	3/2016	Kachwalla	D14/216
D557,682 S *	12/2007	Oas	D14/192	D756,955 S *	5/2016	Wagner	D14/203.6
D560,209 S *	1/2008	Kim	D14/215	D756,957 S *	5/2016	Nylen	D14/204
D567,694 S *	4/2008	Myers	D10/121	D768,113 S *	10/2016	Lee et al.	
D577,356 S *	9/2008	Moon	D14/168	D768,114 S *	10/2016	Hou	D13/168
D591,269 S *	4/2009	Kim	D14/216	D768,597 S *	10/2016	Andre	D14/204
D596,159 S *	7/2009	Yamaji	D14/209.1	D770,417 S *	11/2016	Chen	D14/216
D596,622 S *	7/2009	Lee	D14/218	D790,510 S *	6/2017	Xiao	D14/216
D597,514 S *	8/2009	Gencarella	D14/138 AC	D797,704 S *	9/2017	Fischer	D14/216
D598,003 S *	8/2009	Park	D14/149	D801,308 S *	10/2017	Ahn	D14/216
D601,564 S *	10/2009	Maeno	D14/400	D814,952 S *	4/2018	Taylor	D10/104.1
D602,911 S *	10/2009	Wang	D14/216	D819,600 S *	6/2018	Jeon	D14/216
D608,541 S *	1/2010	Myers	D3/215	2004/0202343 A1 *	10/2004	Rye	H04M 1/03 381/353
D609,213 S *	2/2010	Yeo	D14/203.1	2013/0028457 A1 *	1/2013	Yeh	H04R 1/10 381/334

\* cited by examiner



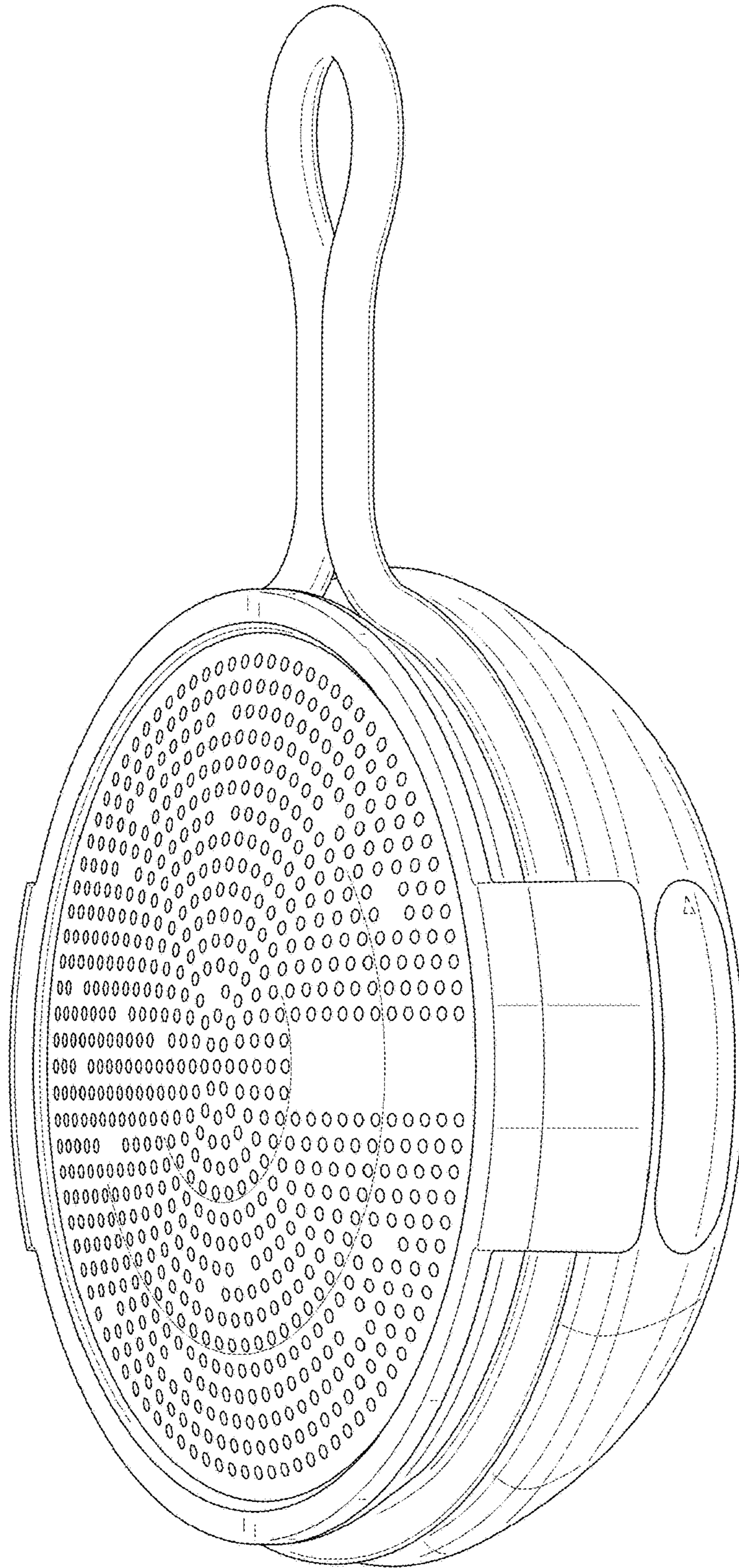

FIG. 1

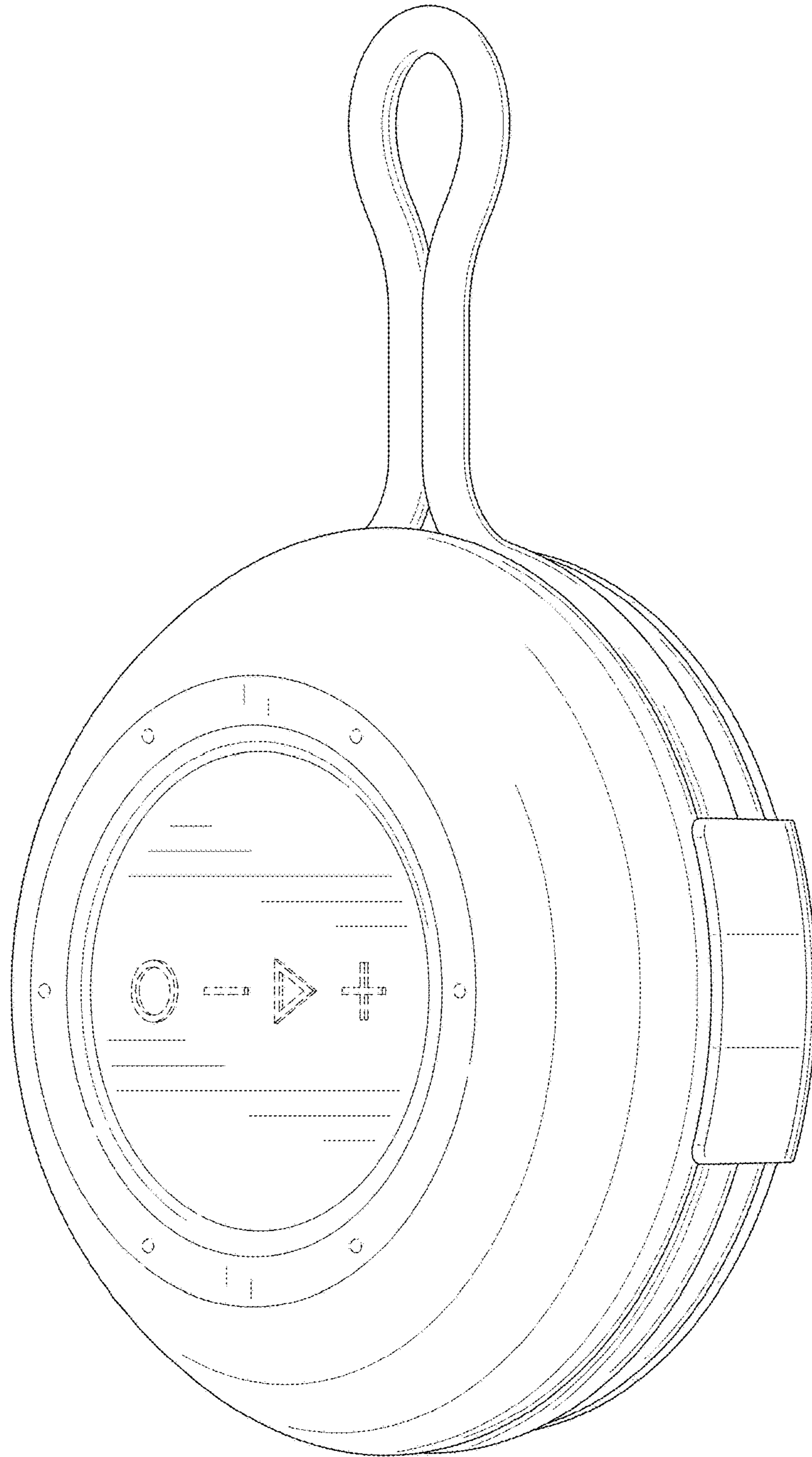

FIG. 2

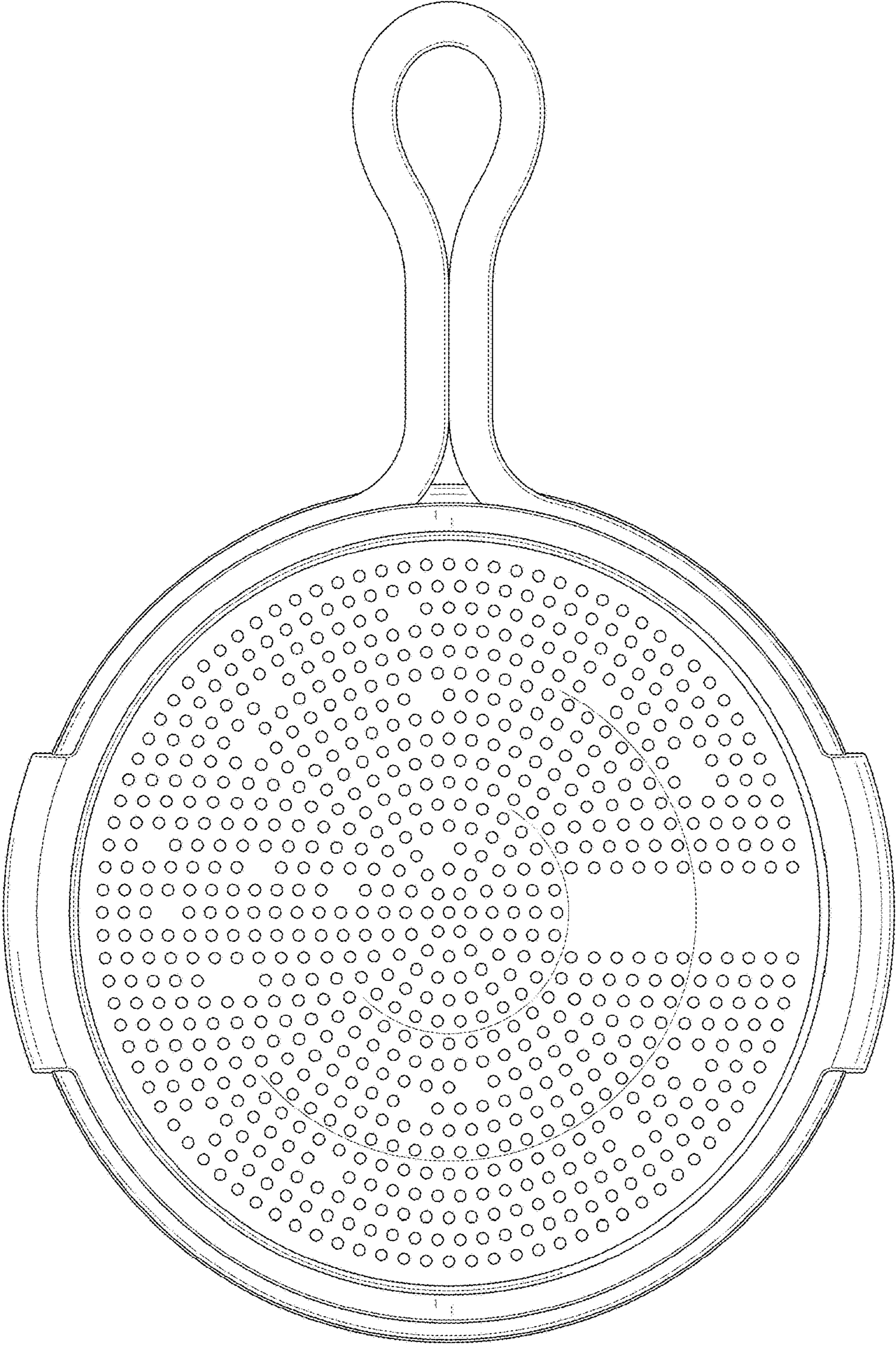

FIG. 3



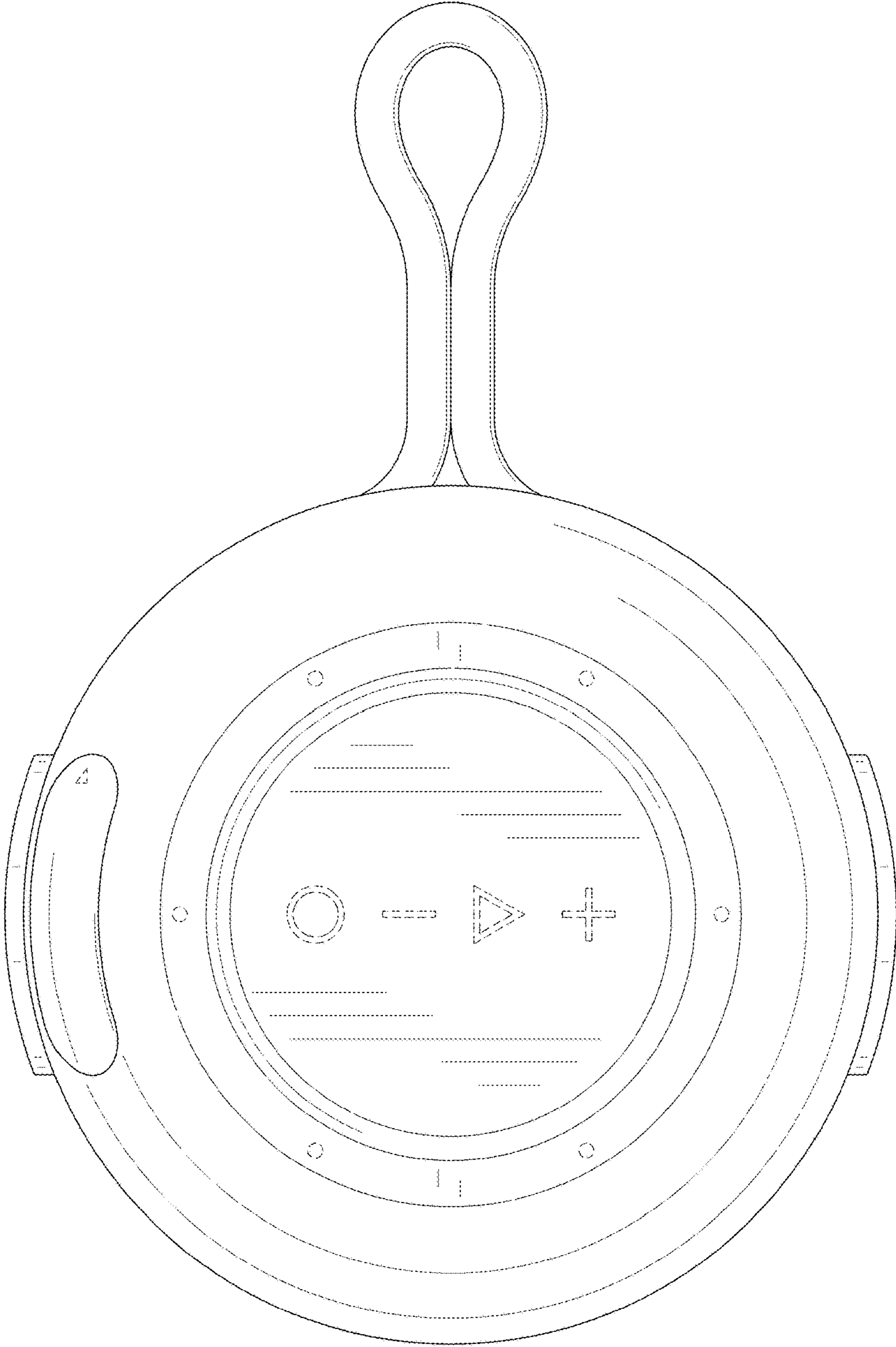

FIG. 4

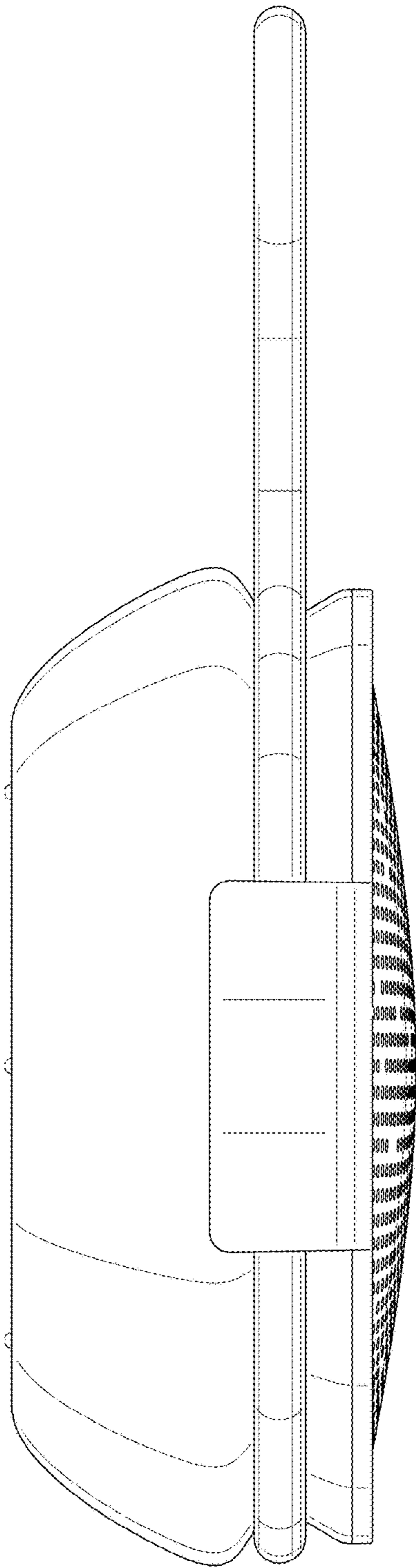

FIG. 5

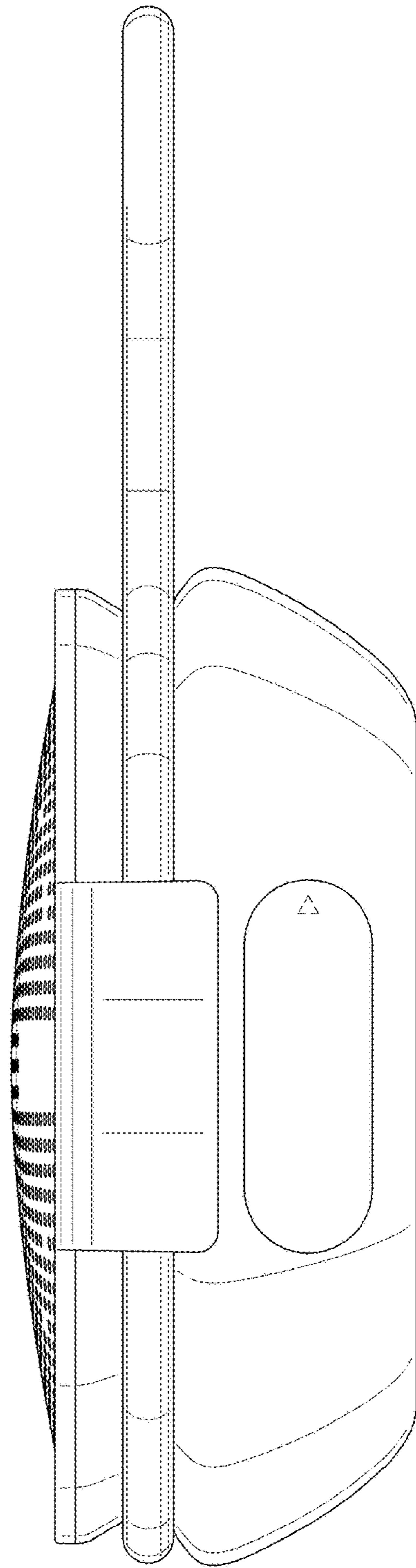

FIG. 6

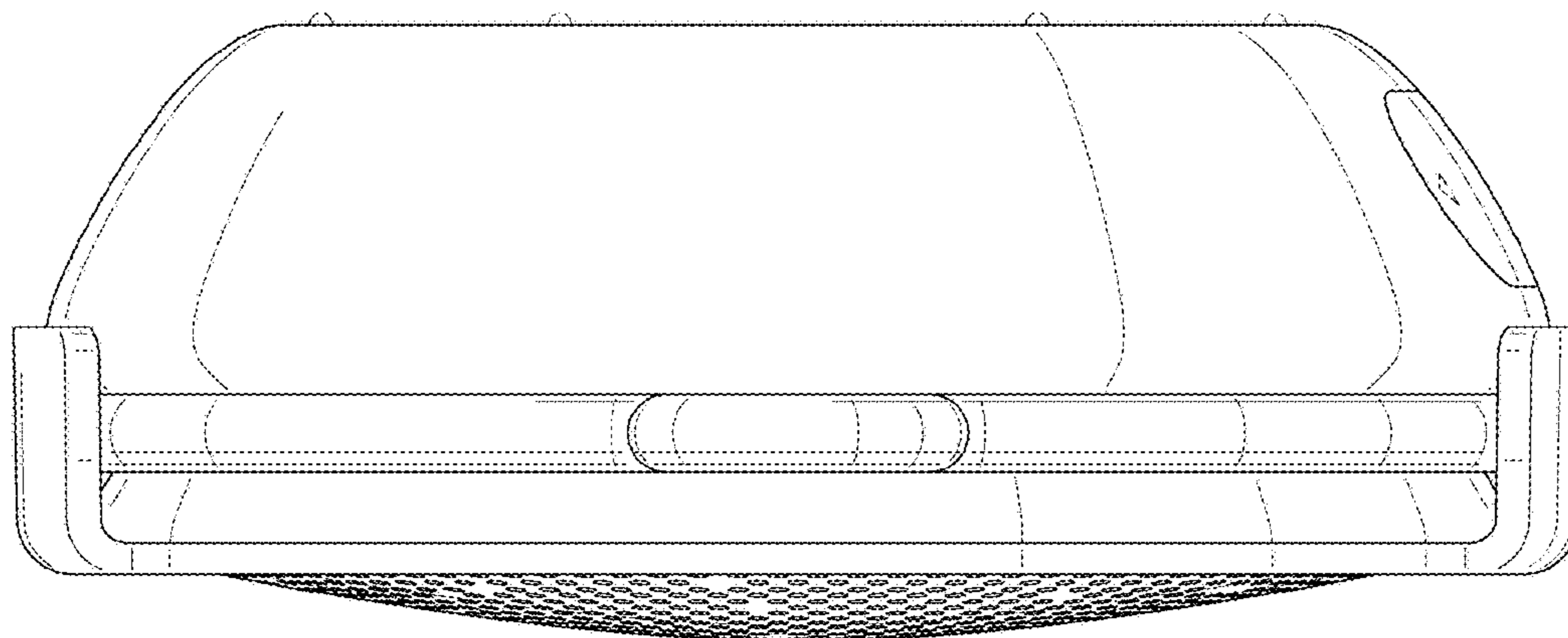

FIG. 7

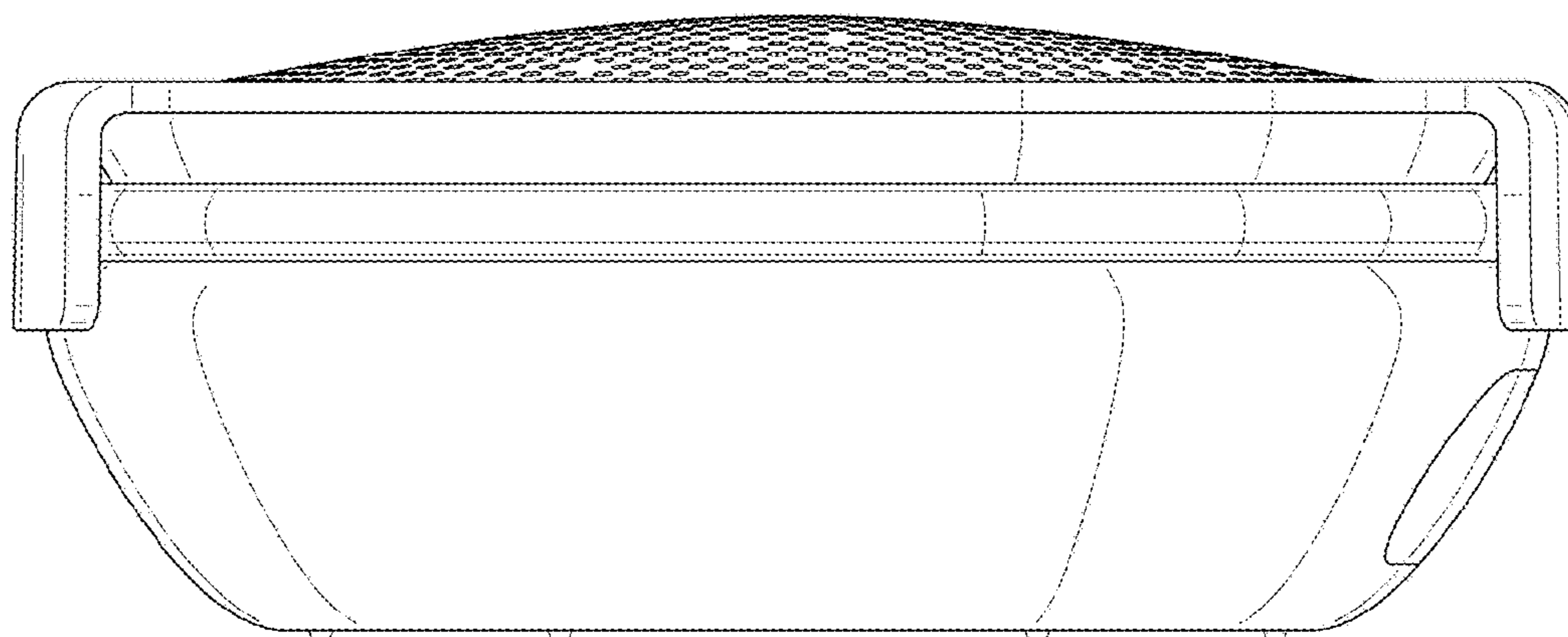

FIG. 8