



US00D828297S

(12) **United States Design Patent**  
**Gan**

(10) **Patent No.:** **US D828,297 S**

(45) **Date of Patent:** **\*\* Sep. 11, 2018**

(54) **INVERTER**

(71) Applicant: **SHENZHEN VALUELINK  
E-COMMERCE CO., LTD.**, Shenzhen  
(CN)

(72) Inventor: **Qingcao Gan**, Shenzhen (CN)

(\*\*) Term: **15 Years**

(21) Appl. No.: **29/619,693**

(22) Filed: **Sep. 29, 2017**

(51) **LOC (11) Cl.** ..... **13-02**

(52) **U.S. Cl.**  
USPC ..... **D13/110**

(58) **Field of Classification Search**  
USPC ..... D13/110, 108, 118, 123, 162, 168, 169,  
D13/174, 177, 184, 199; D14/257, 432,  
D14/438; 174/16.3, 17 R, 17.08;  
361/600, 601, 690, 694, 695, 679.01,  
361/679.61, 704, 730; 363/141, 142  
CPC ..... H05K 5/00; H05K 5/02; H05K 5/0247;  
H05K 7/00; H05K 7/20; H05K 7/20136;  
H05K 7/20154; H05K 7/209; H02M 7/00;  
H02M 7/003; H02M 2001/009; H02J  
7/0042; Y10T 307/367  
See application file for complete search history.

(56) **References Cited**

**U.S. PATENT DOCUMENTS**

5,742,478 A \* 4/1998 Wu ..... H05K 7/20154  
361/704  
5,949,640 A \* 9/1999 Cameron ..... H05K 5/0247  
361/600

D427,147 S \* 6/2000 Wei ..... D13/110  
D437,288 S \* 2/2001 Light ..... D13/110  
D495,296 S \* 8/2004 Hussaini ..... D13/110  
D495,297 S \* 8/2004 Hriscu ..... D13/110  
D544,438 S \* 6/2007 Hussaini ..... D13/110  
D551,621 S \* 9/2007 Iacovelli ..... D13/110  
7,298,627 B2 \* 11/2007 Hussaini ..... H02J 7/0042  
361/753  
D654,021 S \* 2/2012 Sweeney ..... D13/110  
D743,890 S \* 11/2015 Liu ..... D13/110

\* cited by examiner

*Primary Examiner* — Derrick Holland

(74) *Attorney, Agent, or Firm* — Wayne & Ken, LLC;  
Tony Hom

(57) **CLAIM**

The ornamental design for an inverter, as shown and described.

**DESCRIPTION**

FIG. 1 is a perspective view of an inverter showing my new design;  
FIG. 2 is another perspective view thereof;  
FIG. 3 is a front view thereof;  
FIG. 4 is a back view thereof;  
FIG. 5 is a left view thereof;  
FIG. 6 is a right view thereof;  
FIG. 7 is a top view thereof; and,  
FIG. 8 is a bottom view thereof.  
The broken lines shown represent environmental structure and form no part of the claimed design.

**1 Claim, 8 Drawing Sheets**

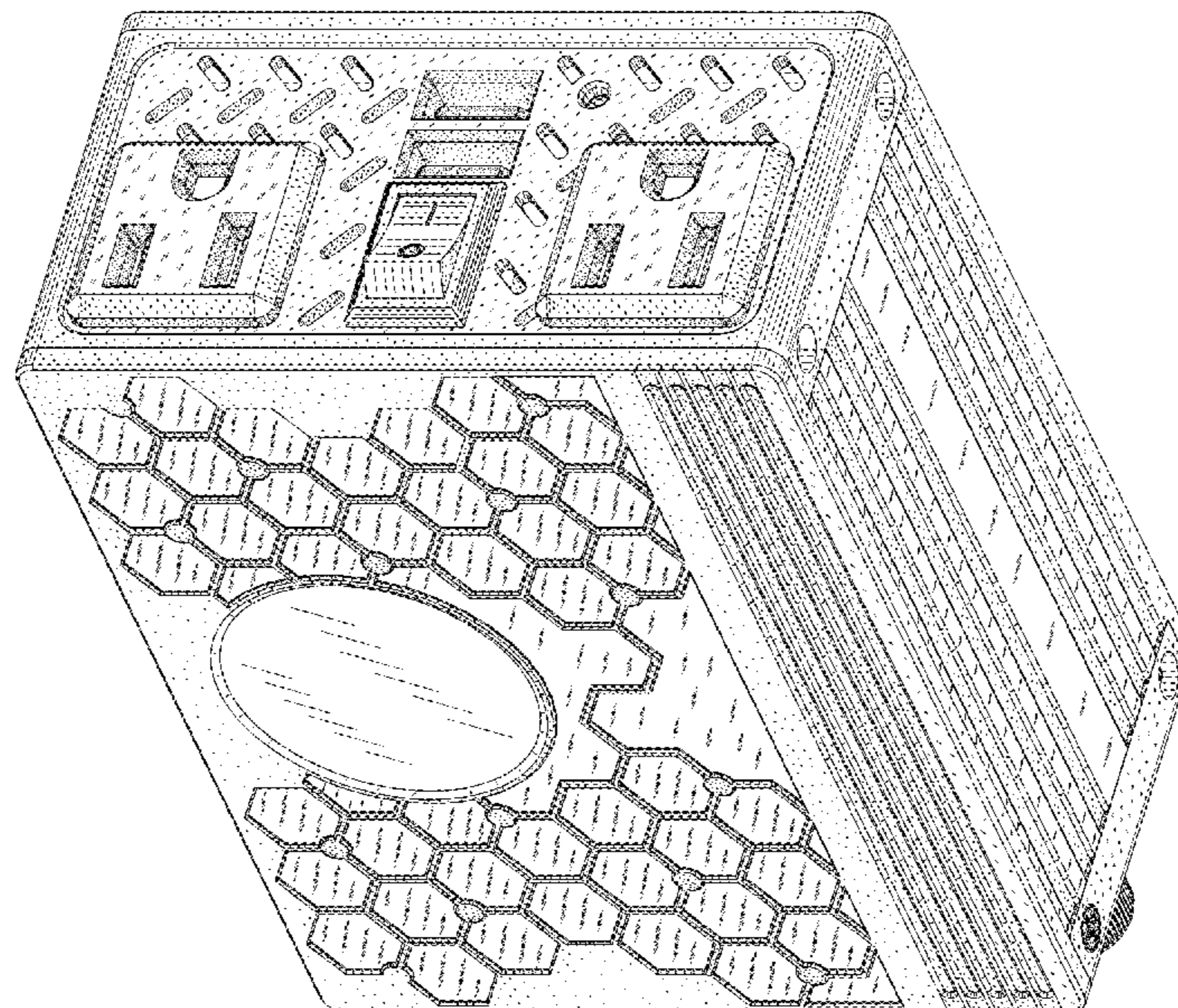

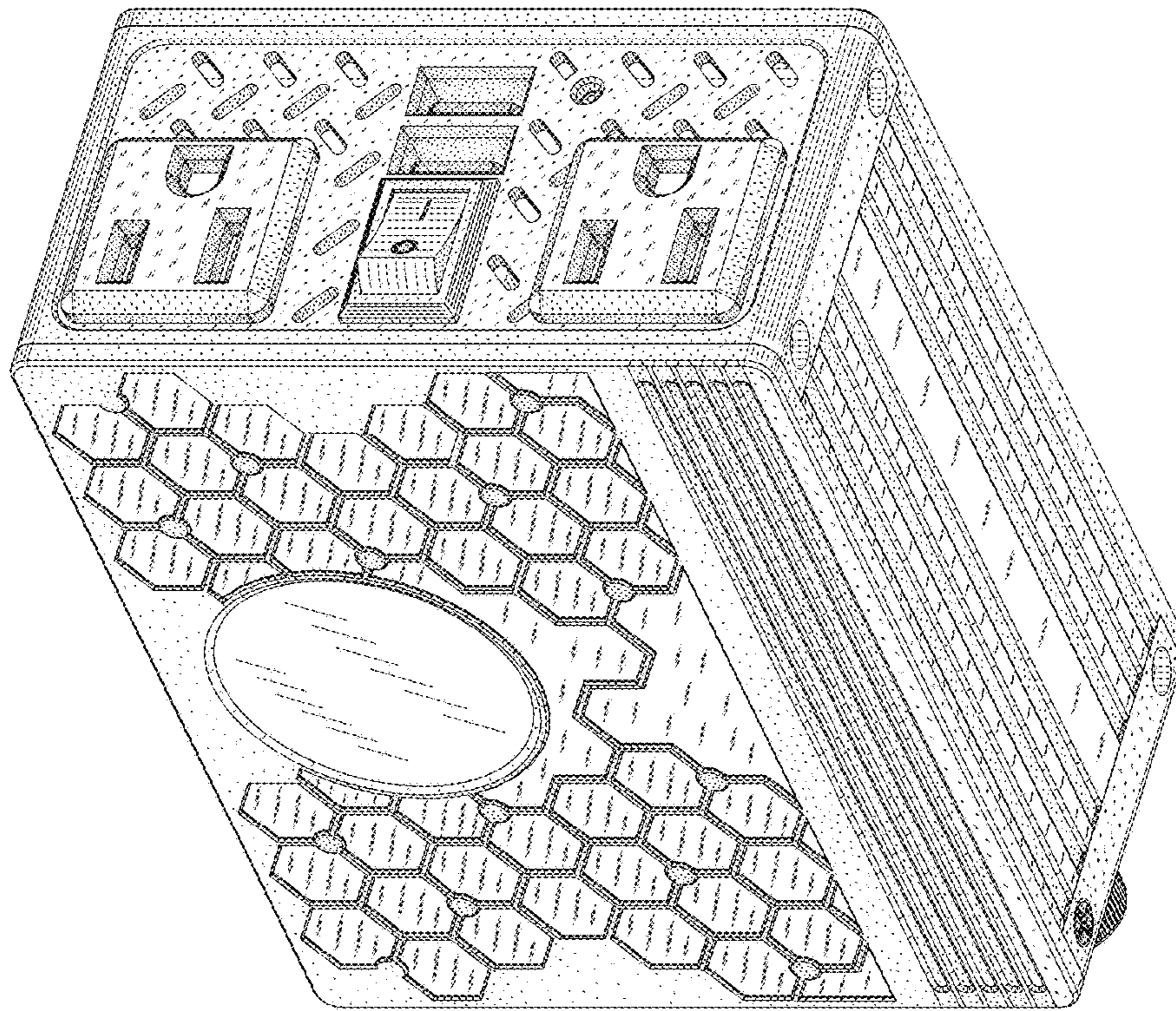

FIG .1

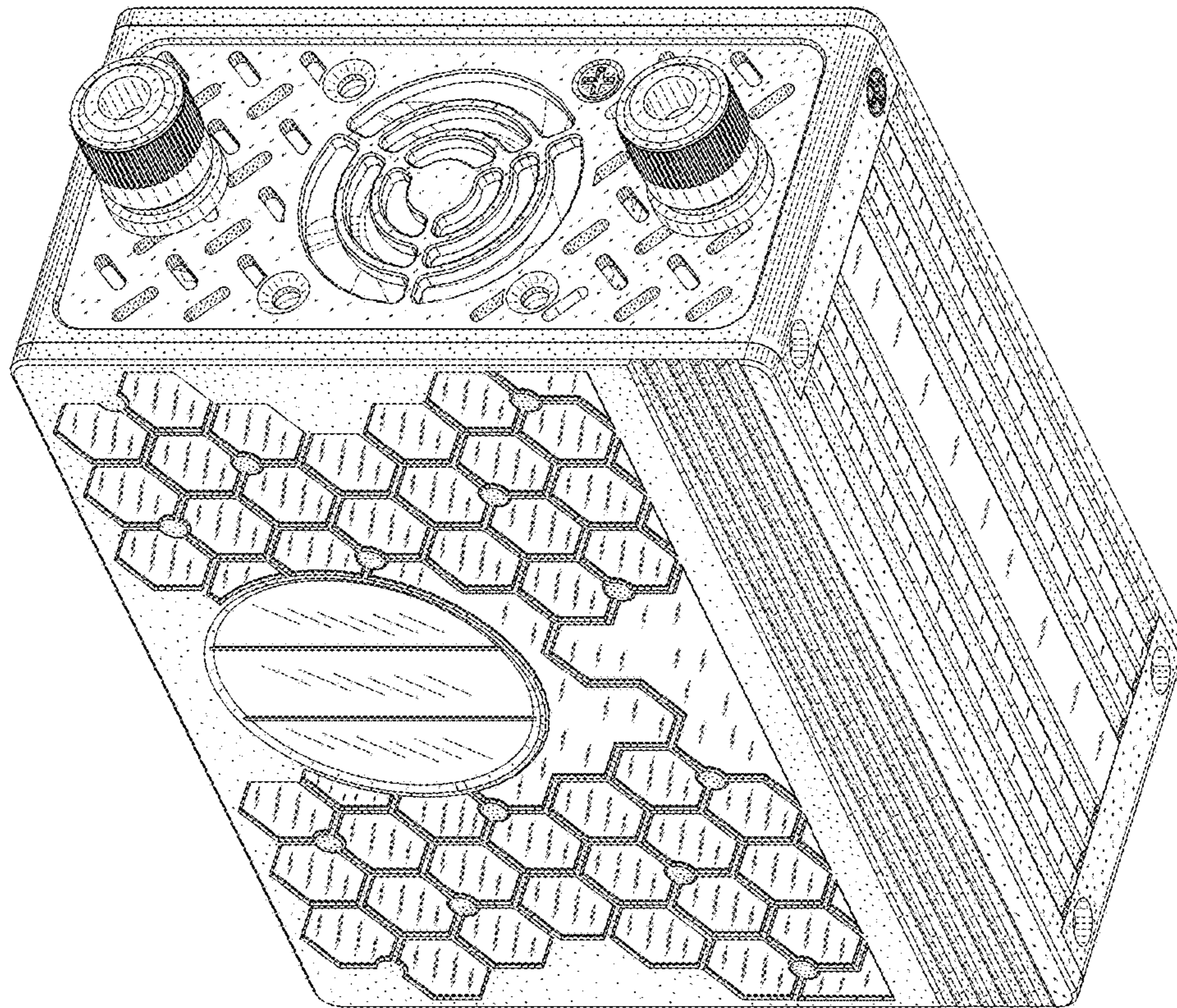

FIG .2

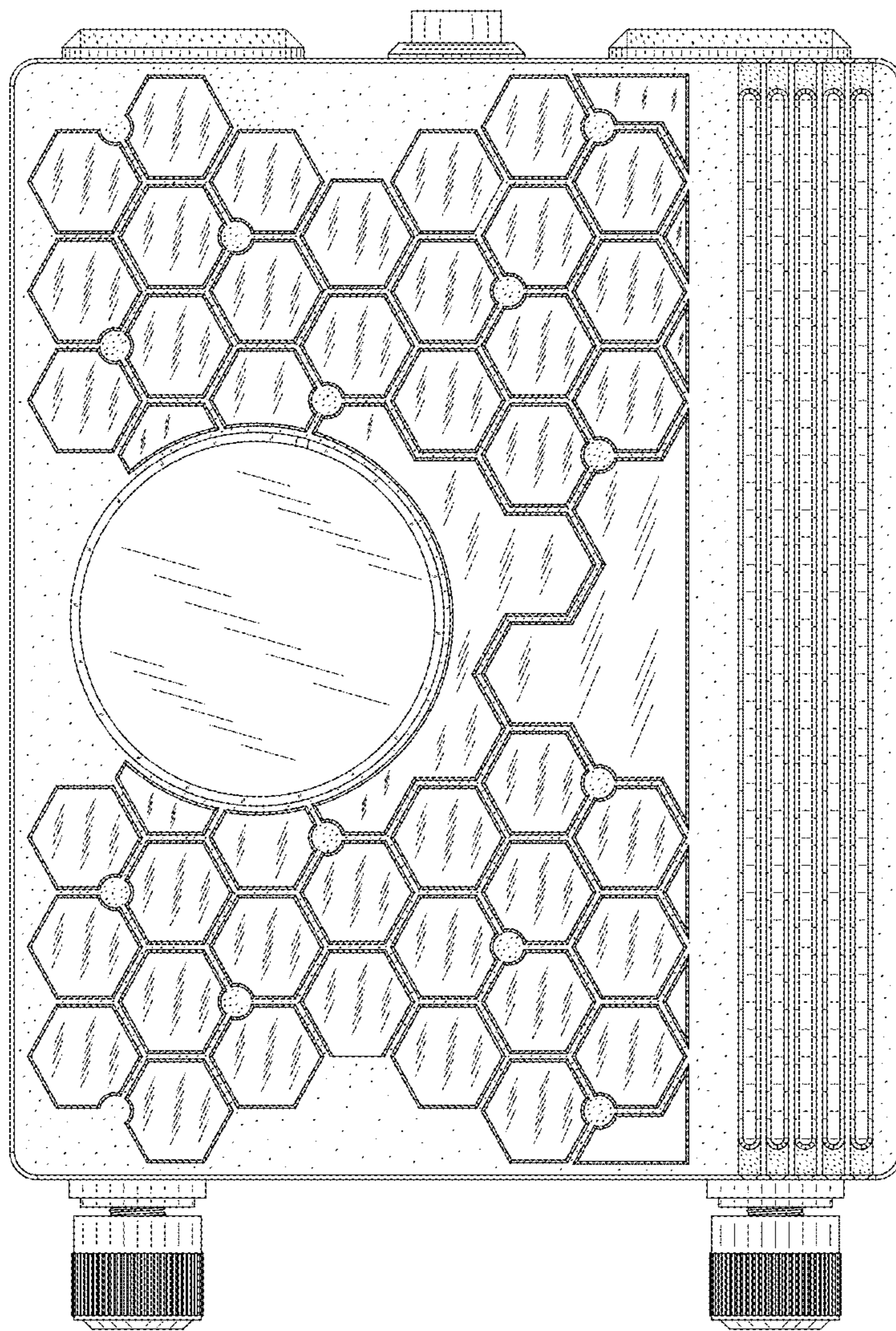

FIG .3

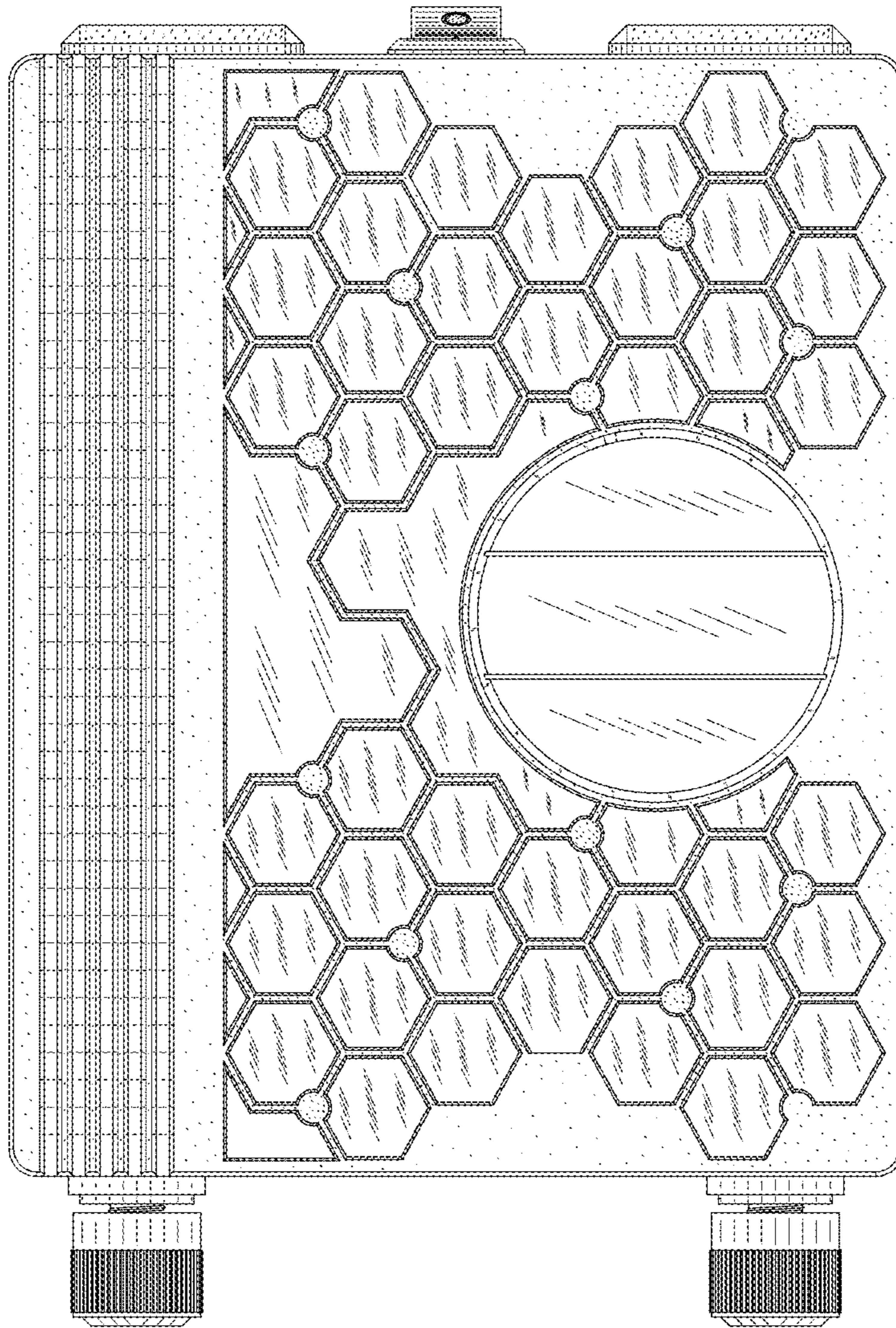

FIG .4

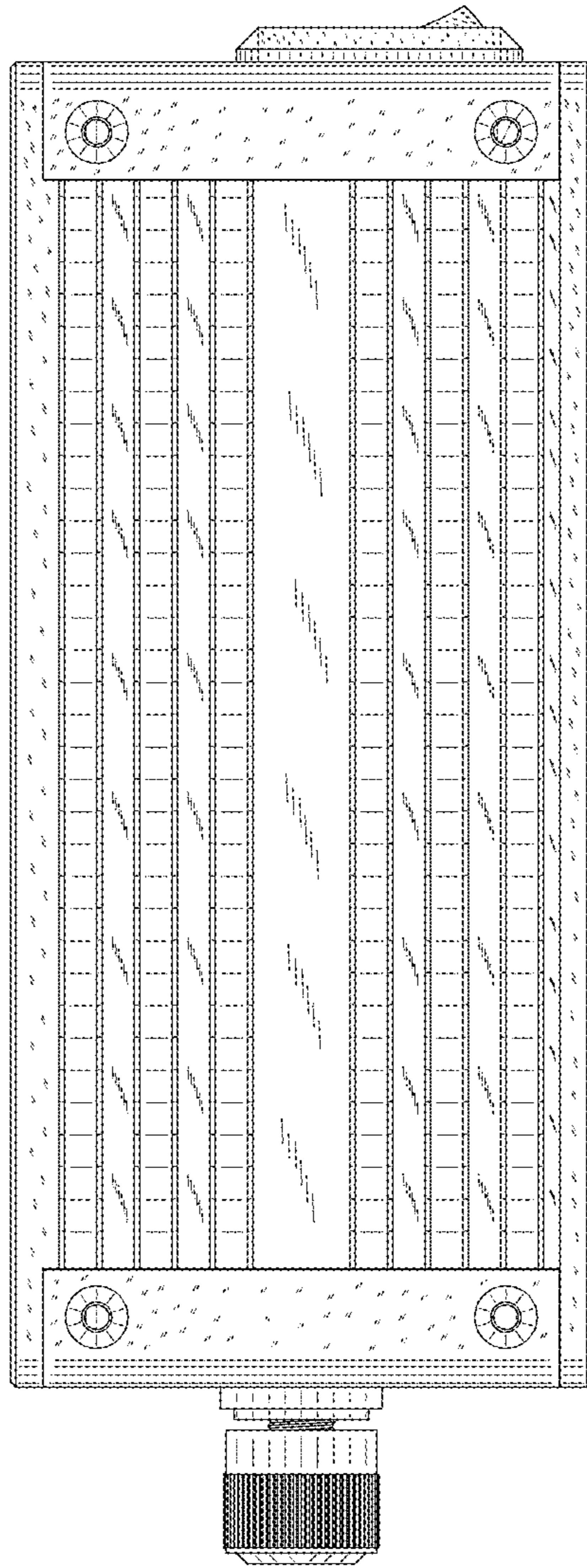

FIG .5

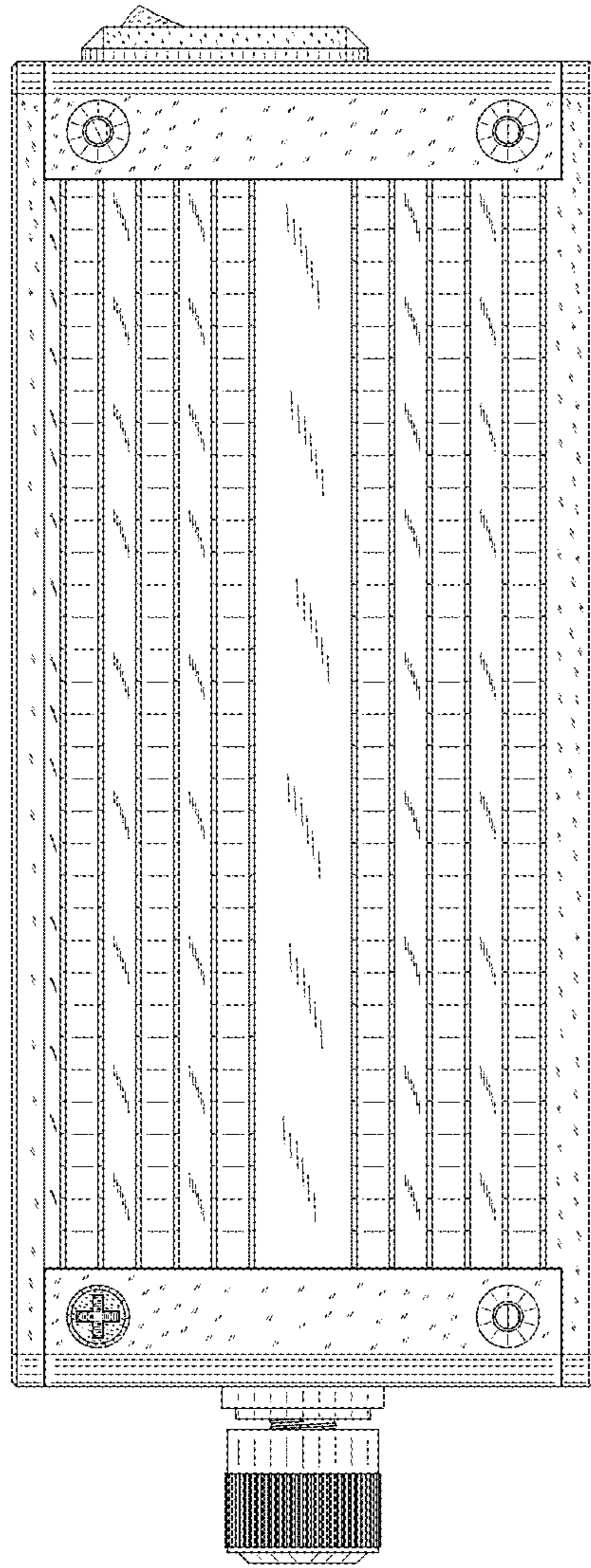

FIG .6

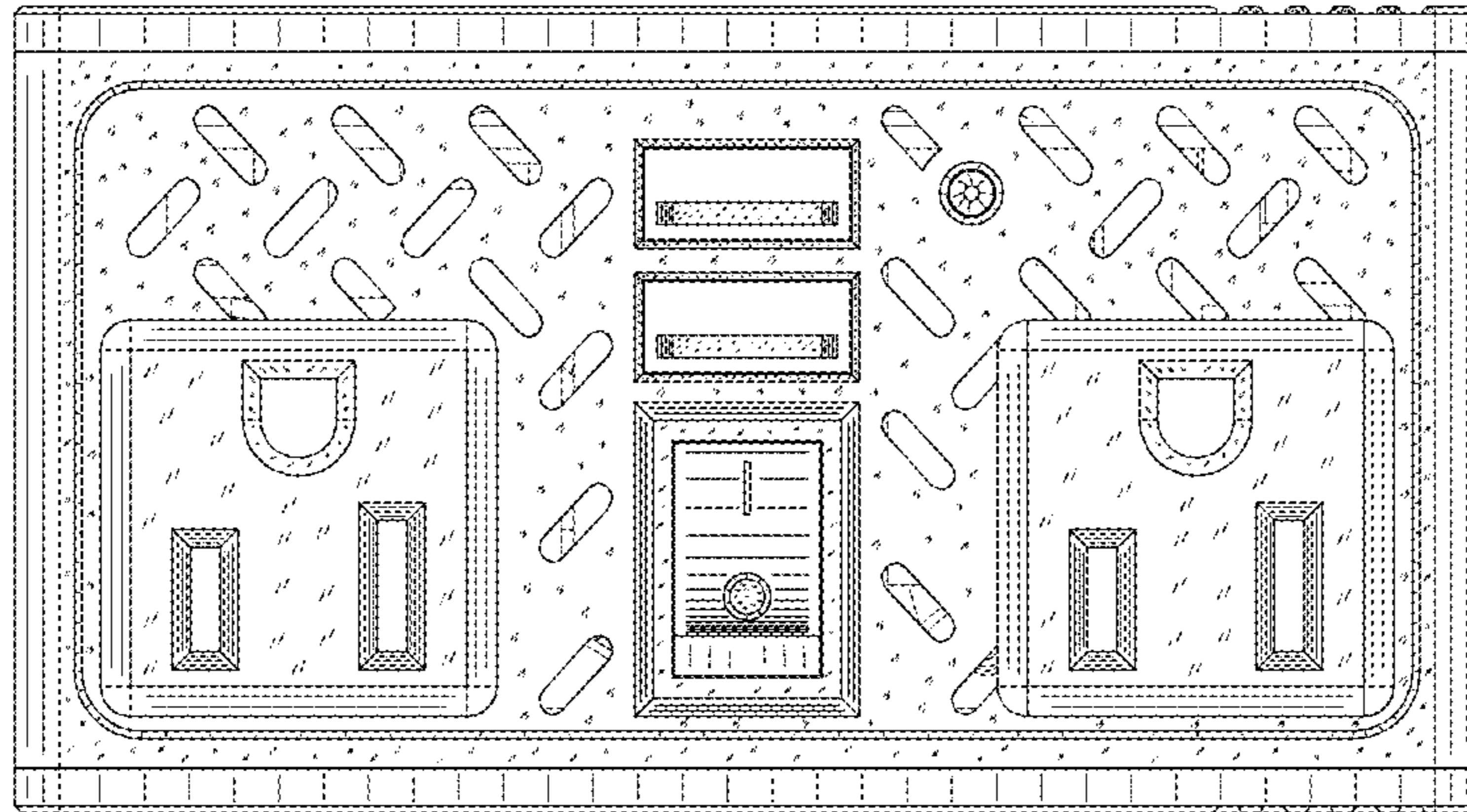

FIG .7



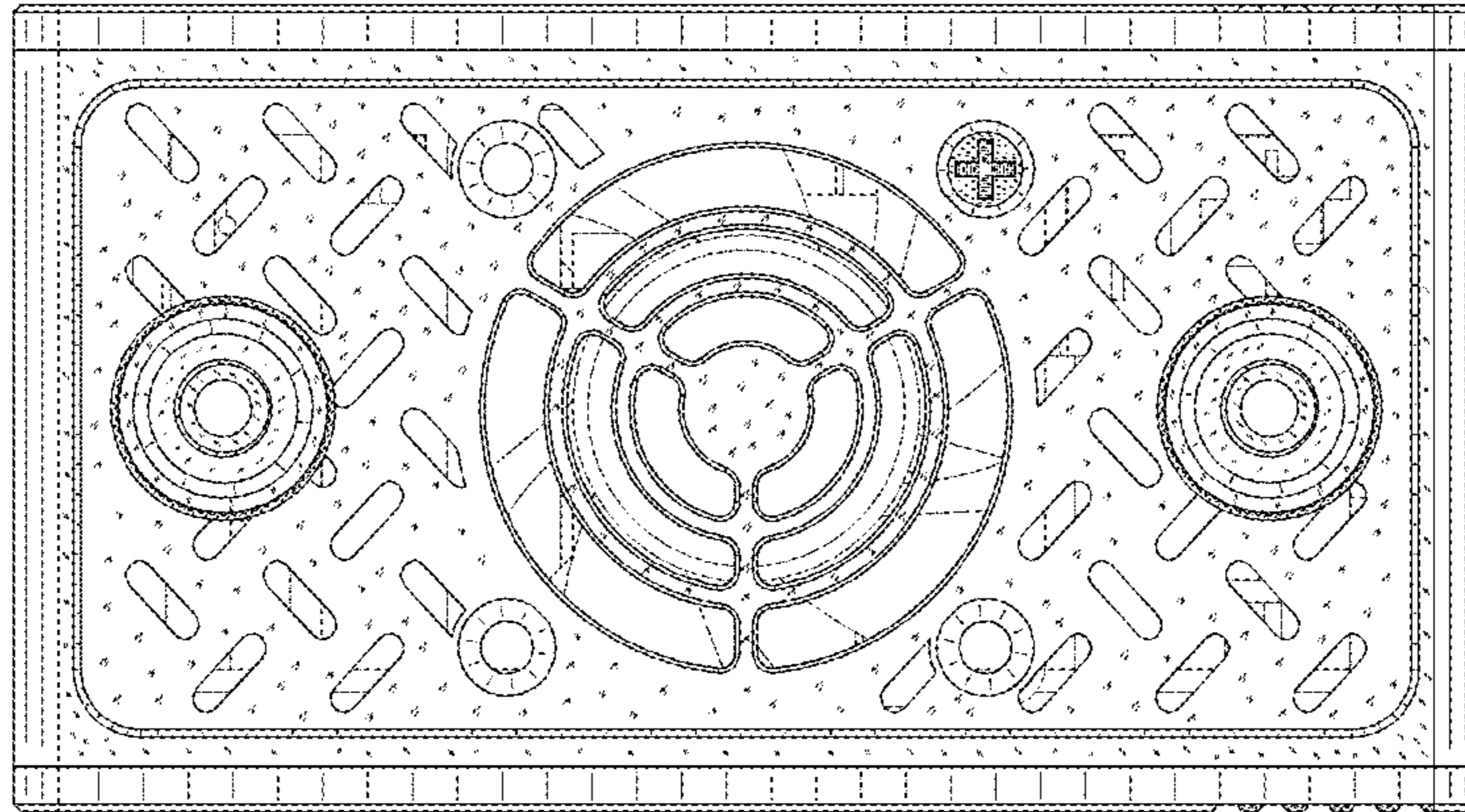

FIG .8