



US00D828182S

(12) **United States Design Patent** (10) **Patent No.:** **US D828,182 S**
Julier et al. (45) **Date of Patent:** **** Sep. 11, 2018**

(54) **BLISTER PACKAGE**

73/0078; B65D 2543/00805; B65D
73/0042; B65D

(Continued)

(75) Inventors: **Henry Vaillant Julier**, Brooklyn, NY
(US); **Tyson Thorne**, Lodi, NJ (US);
Jeffrey S. Silva, Jersey City, NJ (US)

(56) **References Cited**

U.S. PATENT DOCUMENTS

(73) Assignee: **Johnson & Johnson Consumer Inc.**,
Skillman, NJ (US)

D190,396 S * 5/1961 Robinson D9/419
3,207,299 A * 9/1965 Sparks 206/532

(Continued)

Primary Examiner — Lauren R Calve

(**) Term: **14 Years**

(21) Appl. No.: **29/412,647**

(22) Filed: **Feb. 6, 2012**

(57) **CLAIM**

We claim the ornamental design for a blister package, as shown and described.

(51) **LOC (11) Cl.** **09-03**

DESCRIPTION

(52) **U.S. Cl.**
USPC **D9/732**

(58) **Field of Classification Search**
USPC D9/415, 416, 418, 419, 424, 425, 427,
D9/428, 437, 501, 644, 653, 658,
D9/736-762, 902; 206/365, 461-471,
206/484, 485, 486, 493, 528, 531, 532,
206/534, 538, 539, 775-783; D24/121,
D24/227, 229, 224; D7/538, 541, 546,
D7/549, 553.6, 553.3, 557, 586, 628;
D3/203.2, 203.3, 310, 309, 311, 312, 313;
D26/9, 11, 22, 23, 39, 101

CPC B65D 75/327; B65D 2585/56; B65D
75/367; B65D 75/32; B65D 2575/3227;
B65D 83/0445; B65D 2575/367; B65D
2575/3245; B65D 83/04; B65D 75/22;
B65D 75/5855; B65D 75/323; B65D
2543/00296; B65D 5/4204; B65D 25/04;
B65D 75/52; B65D 75/585; B65D
73/0035; B65D 73/0085; B65D 75/58;
B65D 2543/00194; B65D 1/36; B65D

FIG. 1 is a right, front, top perspective view of the first embodiment of a blister package;
FIG. 2 is a front plan view of the blister package of FIG. 1;
FIG. 3 is a back elevational view of the blister package of FIG. 1;
FIG. 4 is a left side view of the blister package of FIG. 1;
FIG. 5 is a right side view of the blister package of FIG. 1;
FIG. 6 is a top side view of the blister package of FIG. 1;
FIG. 7 is a bottom side view of the blister package of FIG. 1;
FIG. 8 is a right, front, top perspective view of the second embodiment of a blister package;
FIG. 9 is a front plan view of the blister package of FIG. 8;
FIG. 10 is a back elevational view of the blister package of FIG. 8;
FIG. 11 is a left side view of the blister package of FIG. 8;
FIG. 12 is a right side view of the blister package of FIG. 8;
FIG. 13 is a top side view of the blister package of FIG. 8;
and,
FIG. 14 is a bottom side view of the blister package of FIG. 8.

(Continued)

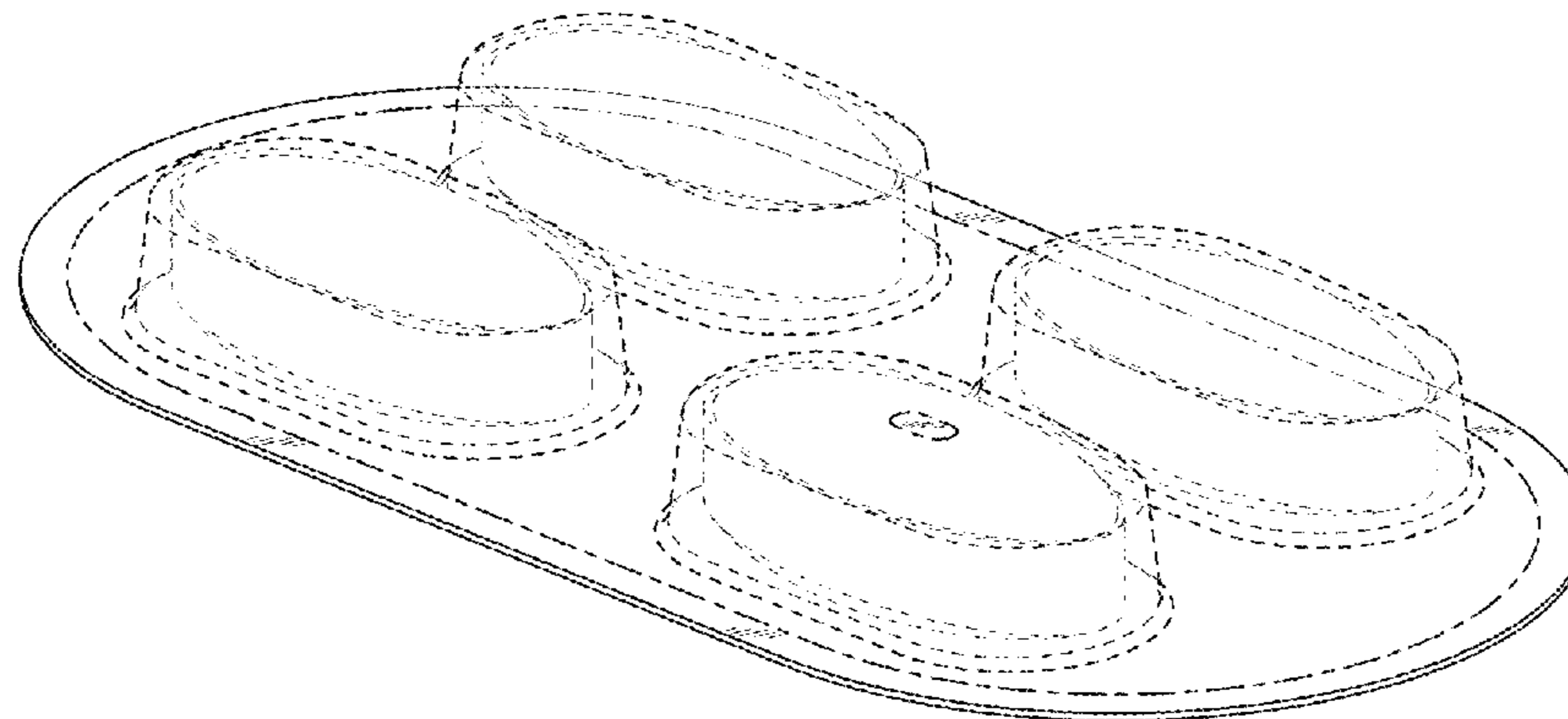

The broken lines are included for the purpose of illustrating portions of the blister package that form no part of the claimed design and represent unclaimed subject matter.

1 Claim, 10 Drawing Sheets

(58) **Field of Classification Search**

CPC 75/225; B65D 77/30; B65D 2543/00092;
B65D 75/522; B65D 1/0223

See application file for complete search history.

(56) **References Cited**

U.S. PATENT DOCUMENTS

3,809,221 A * 5/1974 Compere 206/531
3,912,082 A * 10/1975 Gerner et al. 206/531

4,011,949 A * 3/1977 Braber et al. 206/532
5,560,490 A * 10/1996 Chawla 206/539
6,209,749 B1 * 4/2001 Guess 220/724
6,352,158 B1 * 3/2002 Cole-Bennett et al. 206/532
6,523,691 B2 * 2/2003 Raj et al. 206/538
D517,410 S * 3/2006 Grant D9/457
D588,471 S * 3/2009 Fluegel et al. D9/732
D594,753 S * 6/2009 Eadicicco et al. D9/732
7,673,752 B2 * 3/2010 Levy 206/528
D631,757 S * 2/2011 Kerr et al. D9/732
D665,250 S * 8/2012 Kirk et al. D9/416
2007/0289893 A1 * 12/2007 Williams, Jr. 206/531
2008/0053863 A1 * 3/2008 Glydon et al. 206/531
2009/0134051 A1 * 5/2009 Rapp et al. 206/461
2010/0264153 A1 * 10/2010 Bellamah et al. 220/737
2011/0049003 A1 * 3/2011 Bellamah et al. 206/531
2012/0152796 A1 * 6/2012 Leon Alonso et al. 206/531

* cited by examiner

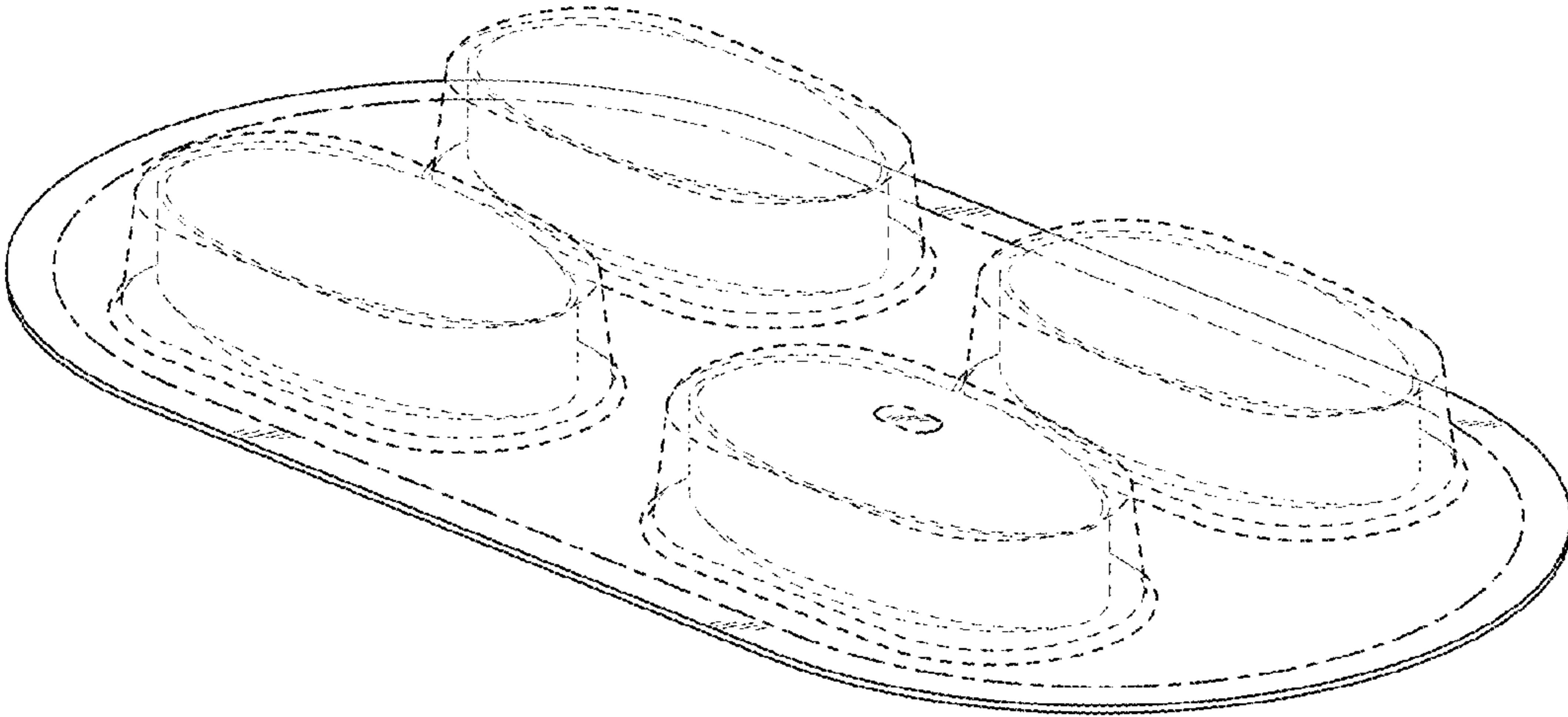

FIG. 1

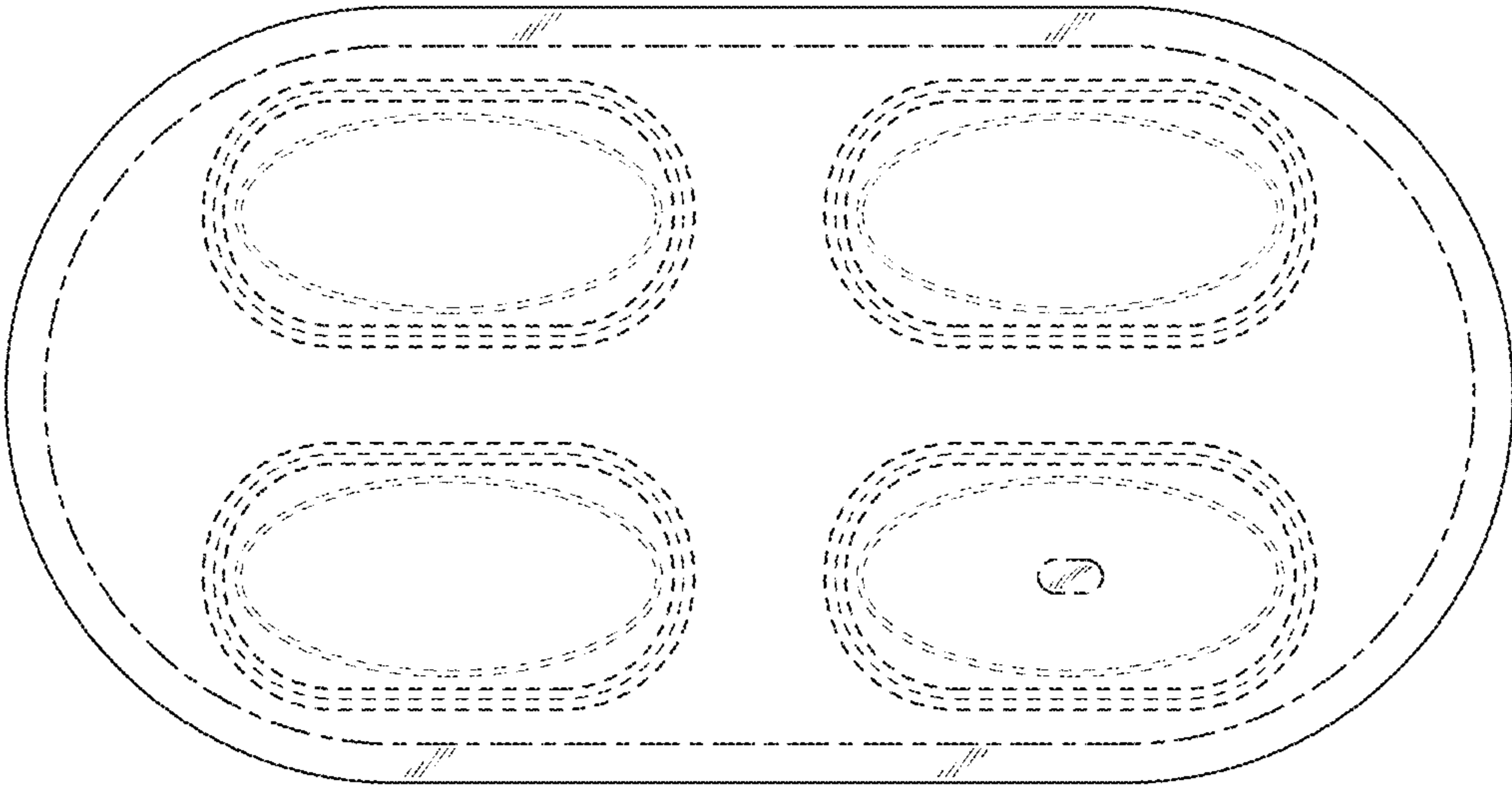

FIG. 2

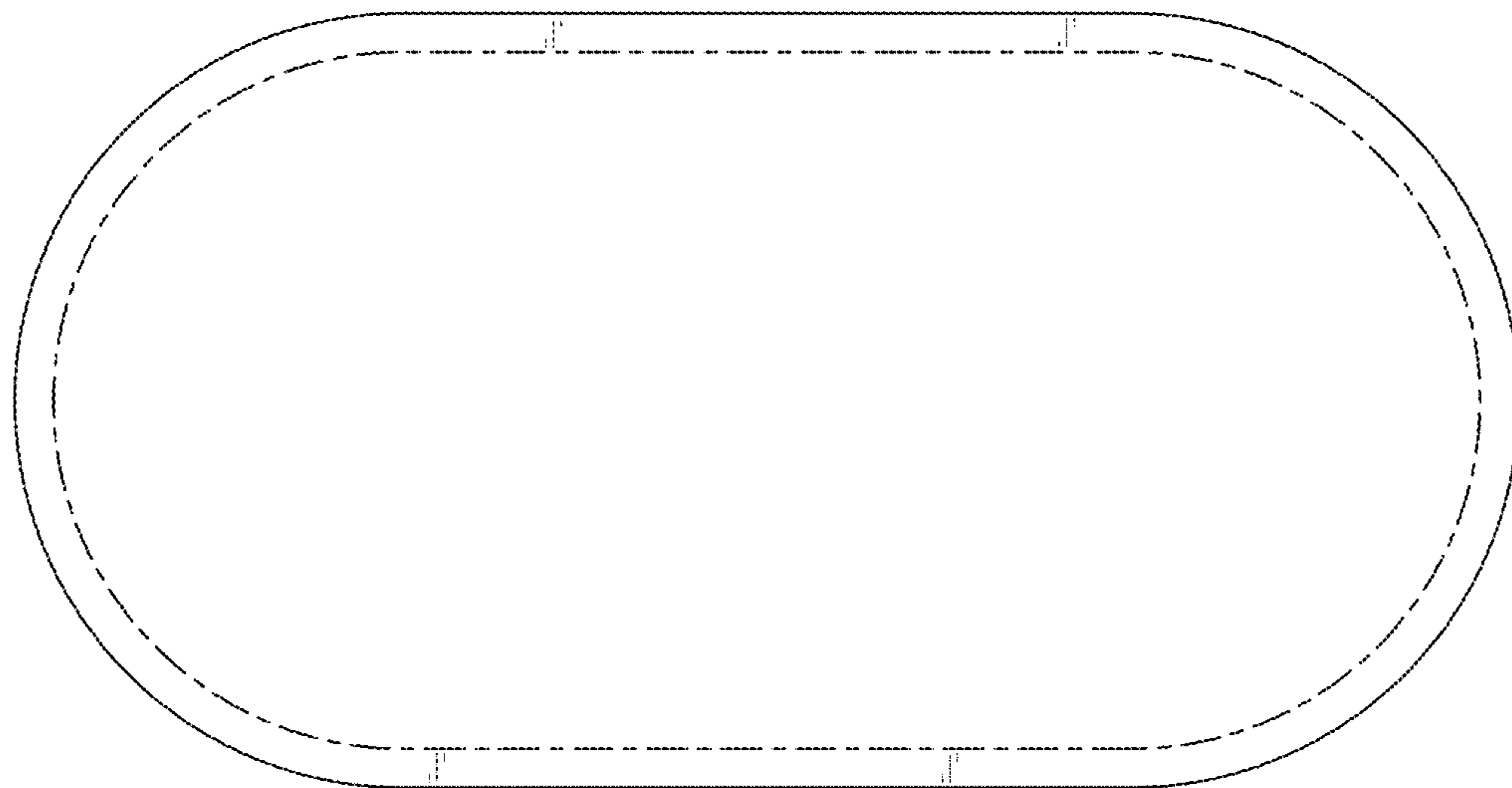

FIG. 3

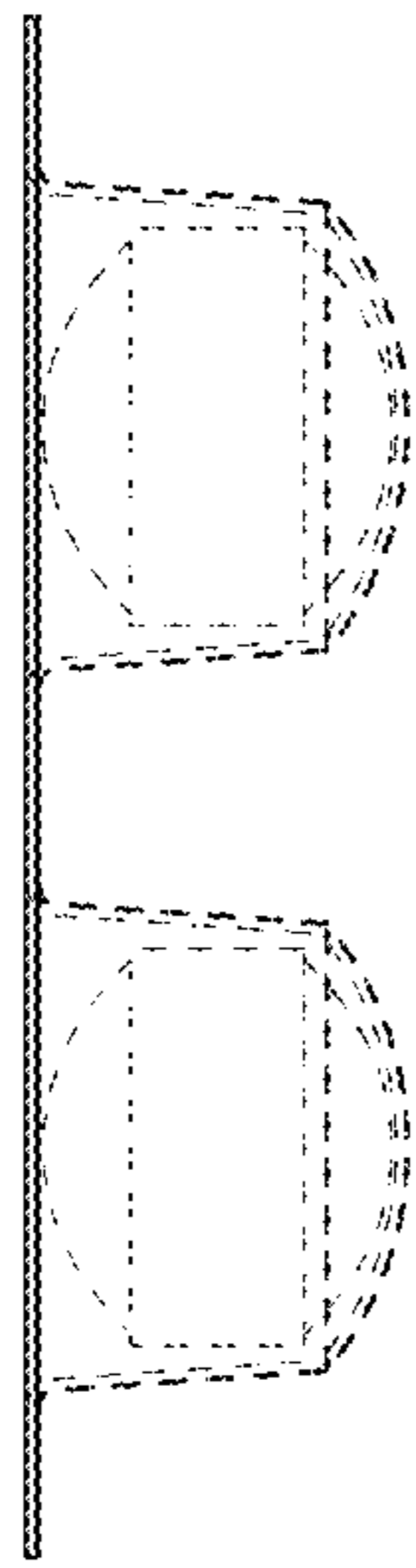

FIG. 4

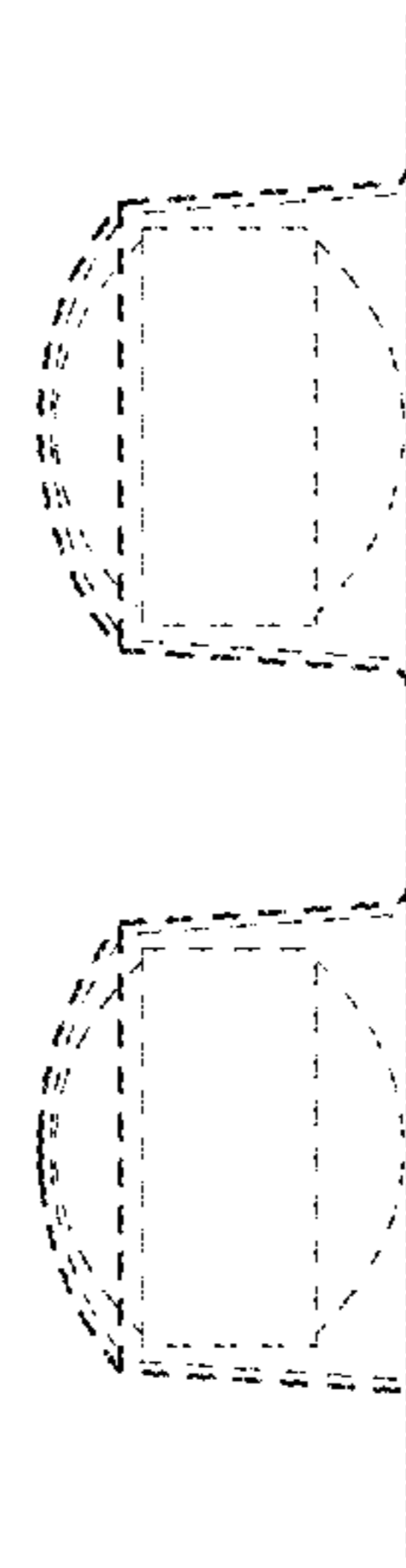

FIG. 5

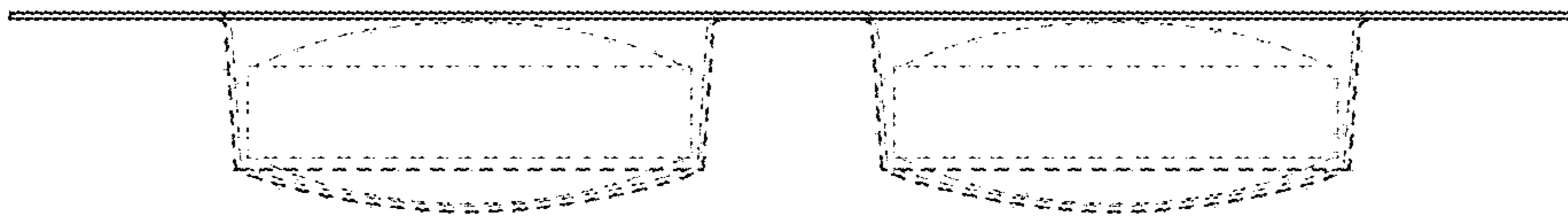

FIG. 6

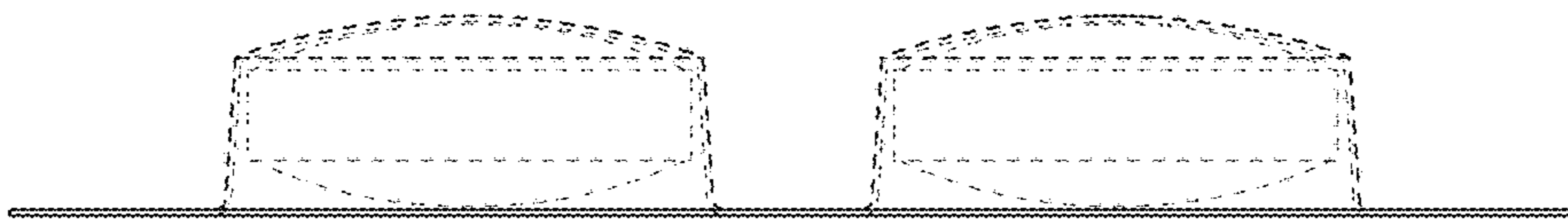

FIG. 7

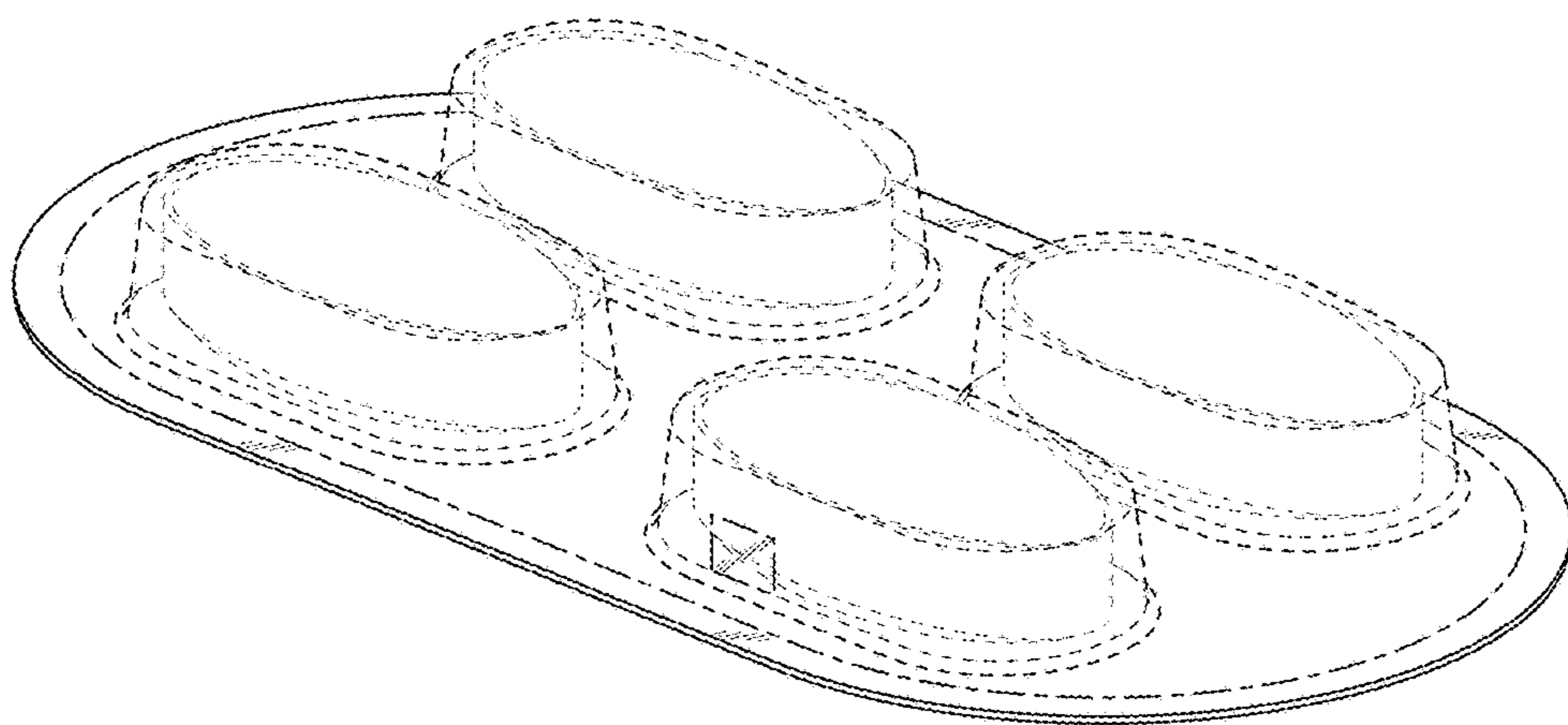

FIG. 8

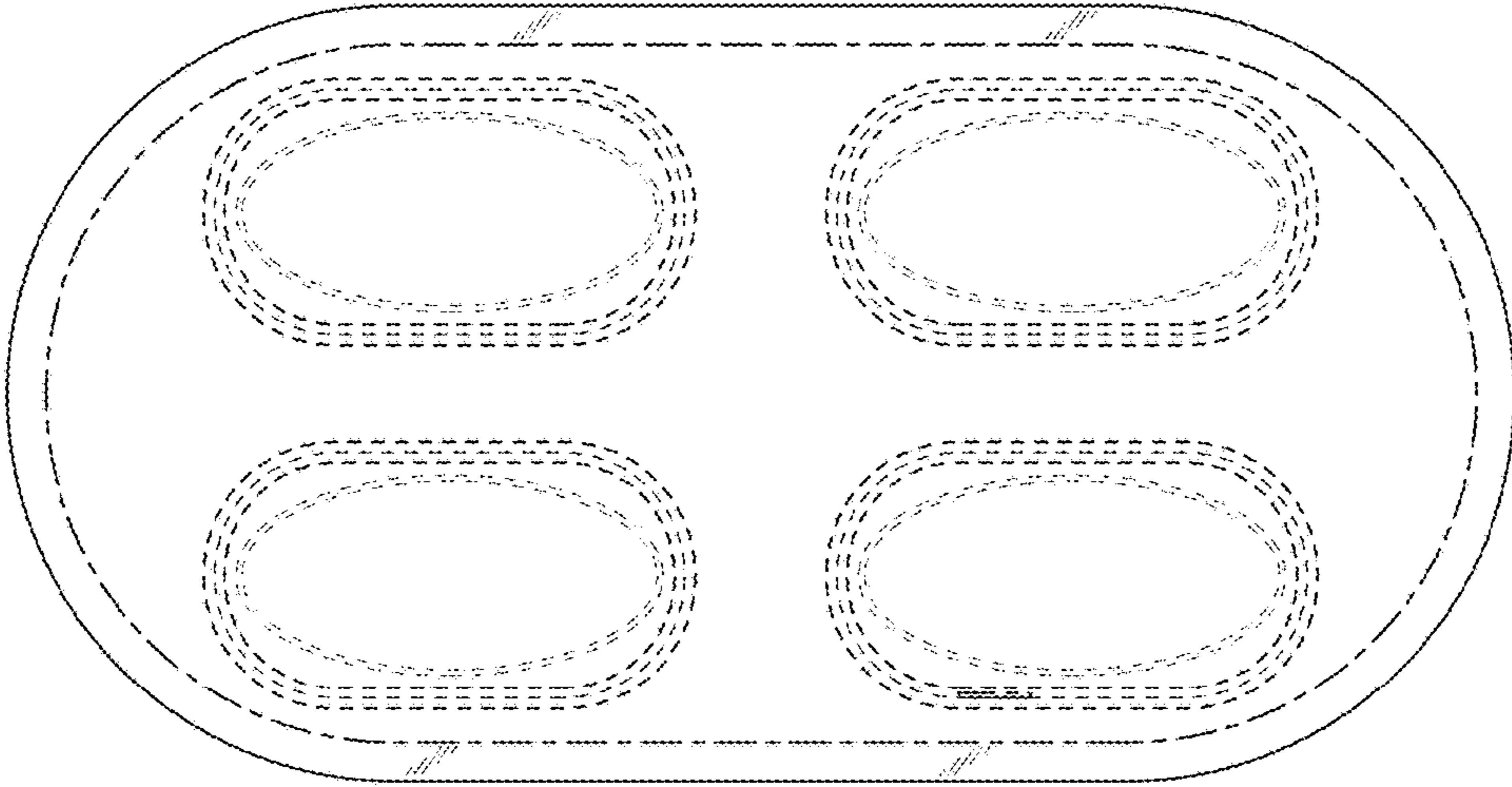

FIG. 9

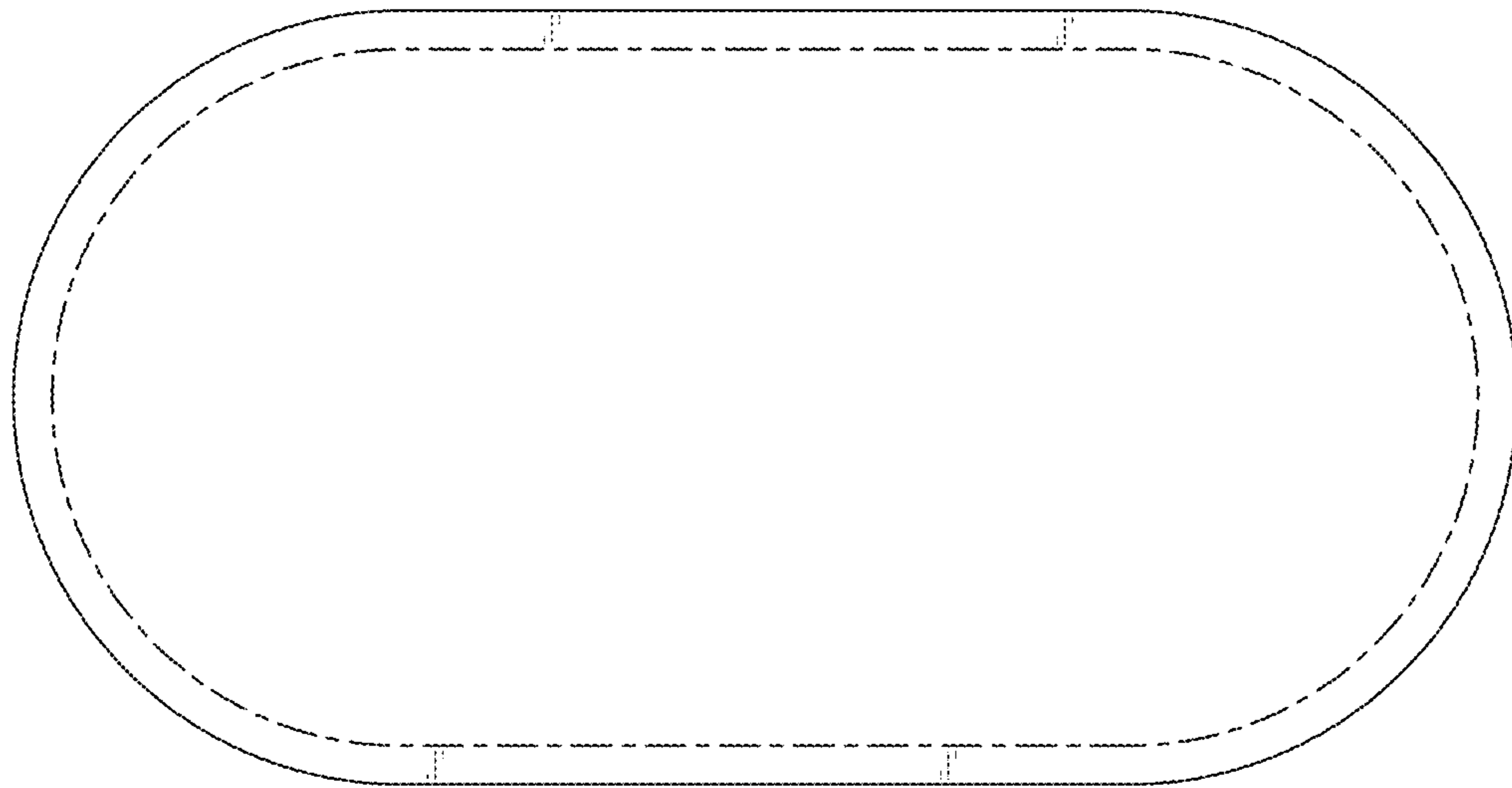

FIG. 10

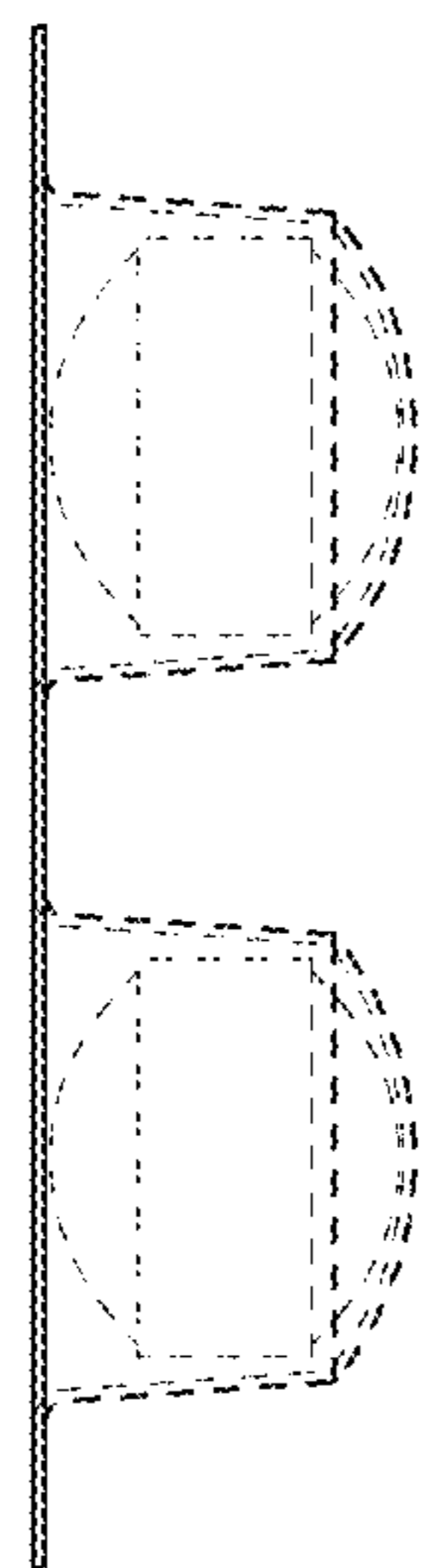

FIG. 11

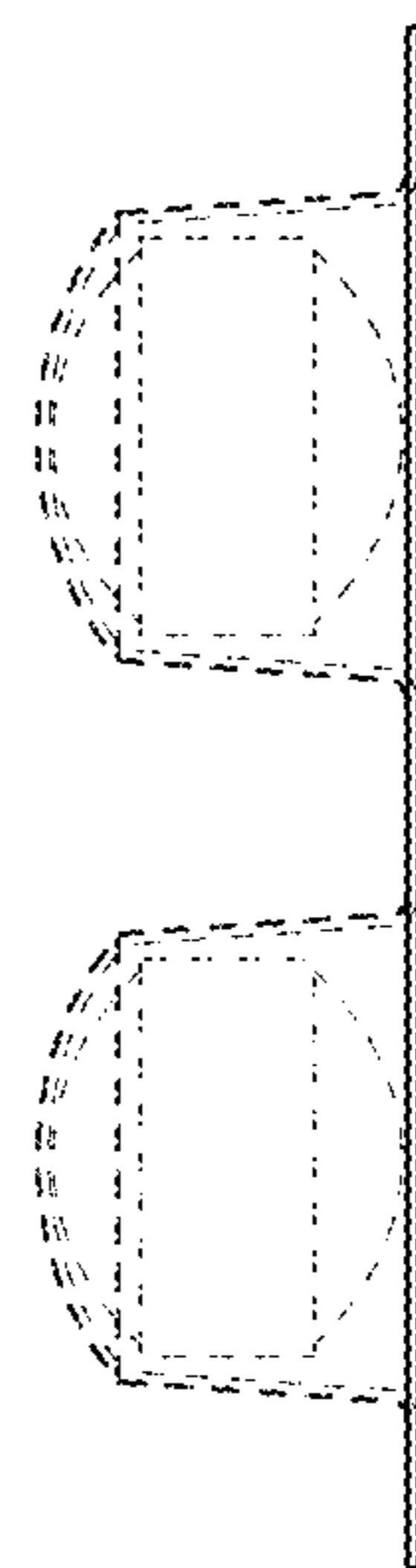

FIG. 12

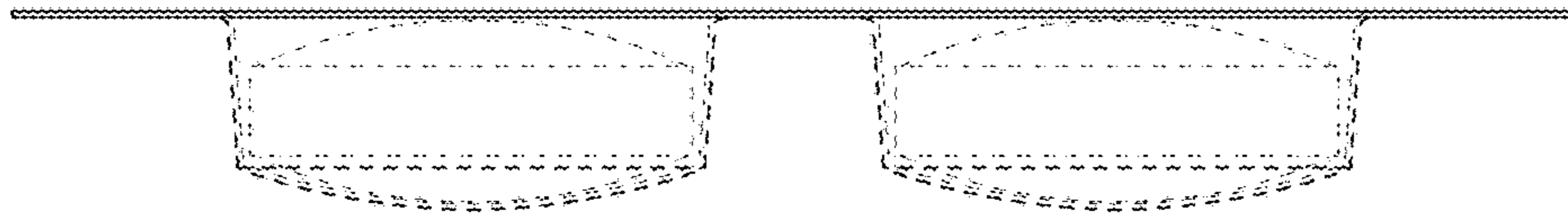

FIG. 13

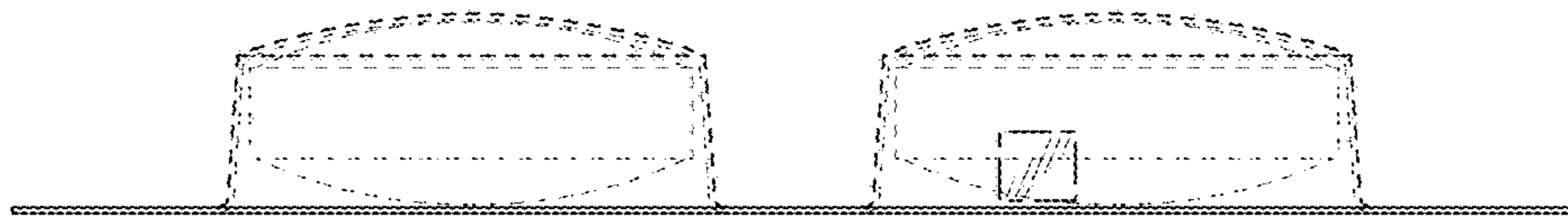

FIG. 14