



US00D828139S

(12) **United States Design Patent** (10) **Patent No.:** **US D828,139 S**
Rizzi et al. (45) **Date of Patent:** **** Sep. 11, 2018**

(54) **HANDLE**

(71) Applicant: **Electrolux Home Products, Inc.**,
Charlotte, NC (US)
(72) Inventors: **Saba Rizzi**, Charlotte, NC (US);
Matthew Ortner, Charlotte, NC (US)
(73) Assignee: **Electrolux Home Products, Inc.**,
Charlotte, NC (US)

(**) Term: **15 Years**

(21) Appl. No.: **29/593,030**

(22) Filed: **Feb. 6, 2017**

(51) **LOC (11) Cl.** **08-06**

(52) **U.S. Cl.**
USPC **D8/316**

(58) **Field of Classification Search**
USPC D8/315-320; D15/85
CPC ... E05Y 2900/531; B25F 5/026; B62D 43/10;
B25G 1/04; E05B 1/0015; E05B 85/10

See application file for complete search history.

(56) **References Cited**

U.S. PATENT DOCUMENTS

D424,873	S	*	5/2000	Holbrook	D7/402
D511,955	S	*	11/2005	Baldwin	D8/301
D542,090	S		5/2007	Kim		
D546,623	S		7/2007	Kim		
D552,959	S	*	10/2007	Gilboe	D8/317
D577,567	S	*	9/2008	Crookshanks	D8/316
D600,529	S	*	9/2009	Nicholson	D8/315
D610,595	S	*	2/2010	Baker	D15/89

(Continued)

OTHER PUBLICATIONS

Electrolux 241930101 Refrigerator Door Handle, posted at amazon.com, posting date Jan. 27, 2015, [online], [site visited Apr. 12, 2018]. Available from Internet, URL: <https://www.amazon.com/Electrolux-241930101-Refrigerator-Door-Handle/dp/B00J7C112G/> (Year: 2015).*

(Continued)

Primary Examiner — Geroge D. Kirschbaum
Assistant Examiner — Maria J Edwards

(74) *Attorney, Agent, or Firm* — Banner & Witcoff, Ltd.

(57) **CLAIM**

The ornamental design for a handle, as shown and described.

DESCRIPTION

FIG. 1 is a front perspective view of a handle showing our new design;
FIG. 2 is a front view thereof;
FIG. 3 is a rear view thereof;
FIG. 4 is a top view thereof;
FIG. 5 is a bottom view thereof;
FIG. 6 is a right side view thereof;
FIG. 7 is a left side view thereof;
FIG. 8 is a front perspective view of the handle of FIGS. 1-7 and including a symbolic break between its end portions.
FIG. 9 is a front view thereof;
FIG. 10 is a rear view thereof;
FIG. 11 is a top view thereof;
FIG. 12 is bottom view thereof;
FIG. 13 is a right side view thereof; and,
FIG. 14 is a left side view thereof.

The broken lines immediately adjacent to the shaded area define the bounds of the claimed design and form no part thereof.

The bracket in FIGS. 8-14 symbolically represents a disclaimed break between its claimed end portions and the appearance of any portions between the break lines forms no part of the claimed design.

The small circular broken lines in FIGS. 3 and 10 illustrate portions of the article and form no part of the claimed design.

1 Claim, 8 Drawing Sheets

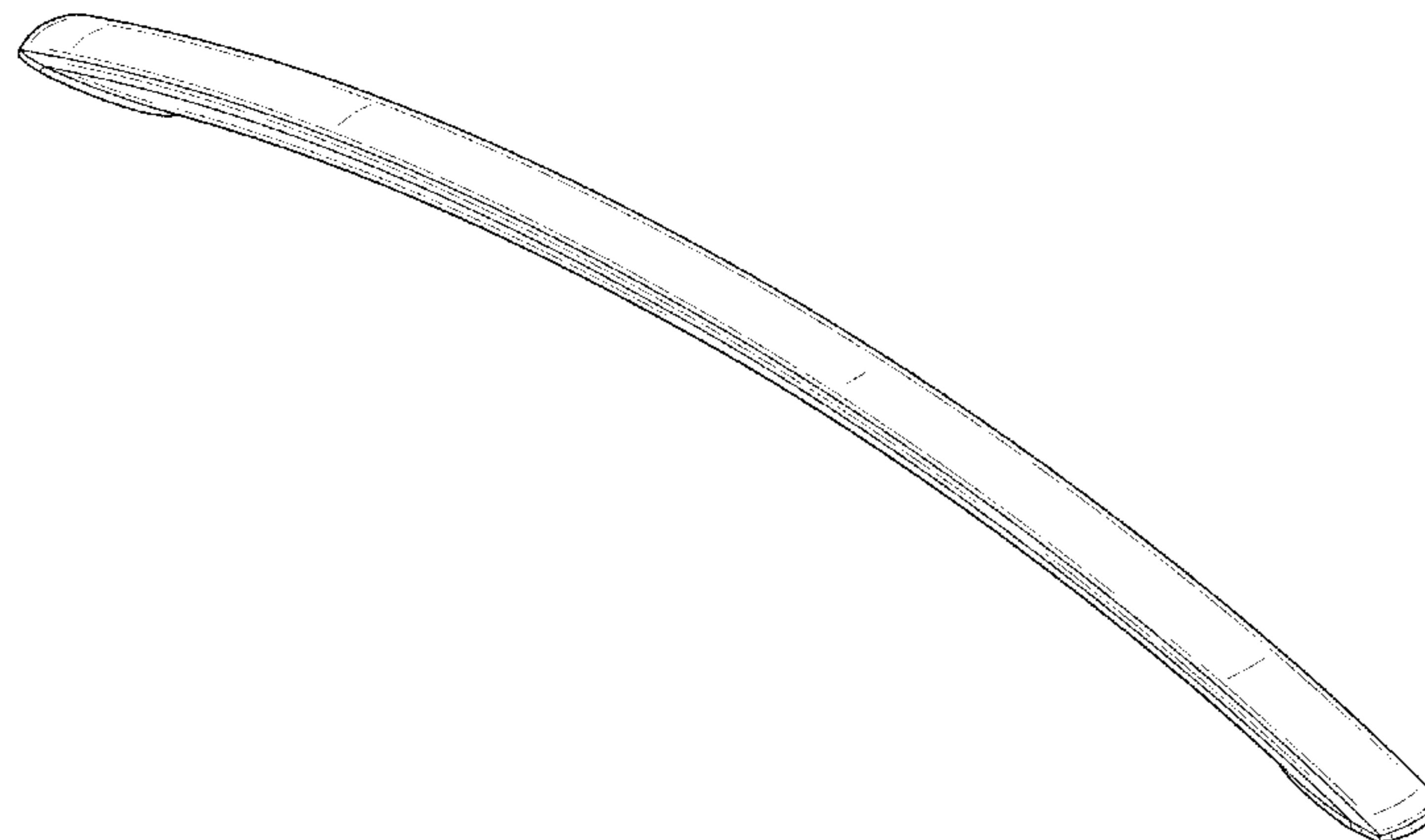

(56)

References Cited

U.S. PATENT DOCUMENTS

D612,681	S	*	3/2010	Baker	D7/405
D614,012	S	*	4/2010	Saubert	D15/89
D614,013	S	*	4/2010	Saubert	D15/89
D646,141	S	*	10/2011	Jeon	D8/316
D680,809	S	*	4/2013	Kim	D7/402
D714,366	S	*	9/2014	Jeon	D15/89
D722,090	S	*	2/2015	Jeon	D15/89
D722,623	S	*	2/2015	Cho	D15/89
D722,624	S	*	2/2015	Cho	D15/89
D722,625	S	*	2/2015	Cho	D15/89
D748,166	S	*	1/2016	Jeon	D15/89
D773,920	S	*	12/2016	Funnell, II	D8/315
D787,571	S	*	5/2017	Seo	D15/91
D788,512	S	*	6/2017	Kim	D7/323
D788,513	S	*	6/2017	Chung	D7/323
D788,828	S	*	6/2017	Seo	D15/86
D805,832	S	*	12/2017	Kim	D7/340
2012/0074826	A1	*	3/2012	Klaus	A47B 95/02 312/405
2012/0227218	A1	*	9/2012	Johnson	A47B 95/02 16/422

OTHER PUBLICATIONS

Electrolux 316270201 Door Handle, posted at amazon.com, posting date Aug. 2, 2008, [online], [site visited Apr. 12, 2018]. Available

from Internet, URL: <https://www.amazon.com/Electrolux-316270201-Door-Handle/dp/B00L5G69Z8> (Year: 2008).*

Electrolux 316554008 Handle, posted at amazon.com, posting date Jan. 27, 2015, [online], [site visited Apr. 12, 2018]. Available from Internet, URL: <https://www.amazon.com/Electrolux-316554008-HANDLE/dp/B00J7DD5FS/> (Year: 2015).*

Electrolux Door Handle 242198301, posted at amazon.com, posting date Jul. 17, 2013, [online], [site visited Apr. 12, 2018]. Available from Internet, URL: <https://www.amazon.com/Electrolux-ELECTROLUX-Handle-Door-242198301/dp/B00DZZSLEO> (Year: 2013).*

Frigidaire FFHB2750TS refrigerator, posted at jcpenny.com, posting date at least by Jun. 21, 2017, [online], [site visited Apr. 12, 2018]. Available from Internet, URL: <https://www.jcpenny.com/p/frigidaire-energy-star-268-cu-ft-french-door-refrigerator/ppr5007334942?pTplType=silver> (Year: 2017).*

Samsung DA97-12715C Handle, posted at amazon.com, posting date Apr. 15, 2013, [online], [site visited Apr. 12, 2018]. Available from Internet, URL: <https://www.amazon.com/Samsung-DA97-12715C-Assy-Handle-Bar-Ref/dp/B00CD6KZNG/> (Year: 2013).*

Universal Oven Door Handle, posted at cookerspareparts.com, posting date not given, [online], [site visited Apr. 12, 2018]. Available from Internet, URL: <https://www.cookerspareparts.com/news/post/universal-oven-door-handle> (Year: 2018).*

* cited by examiner

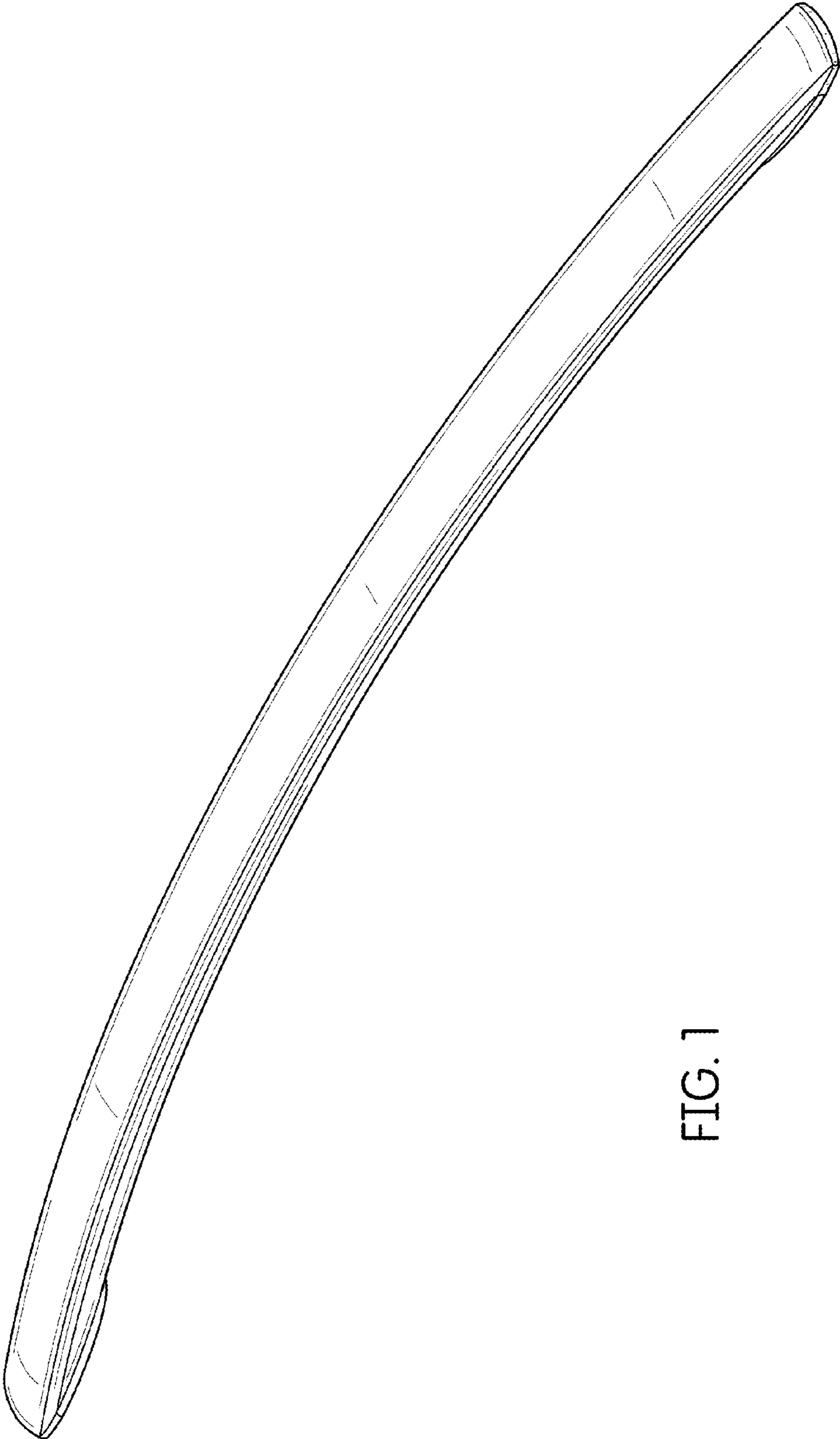

FIG. 1

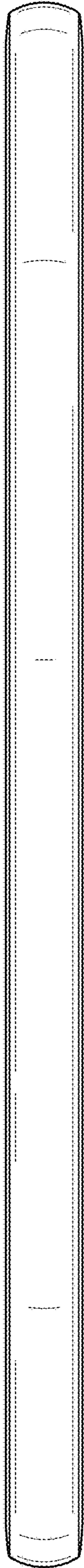

FIG. 2

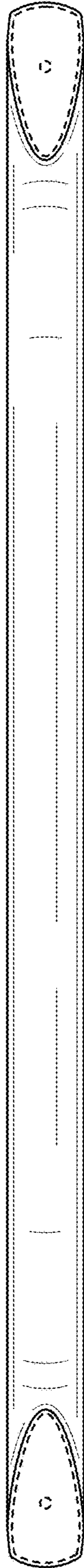

FIG. 3

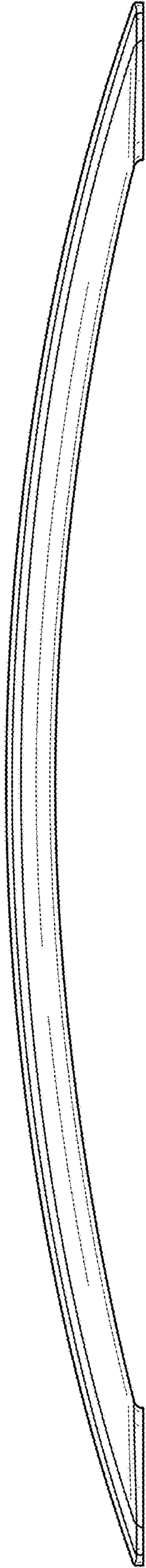

FIG. 4

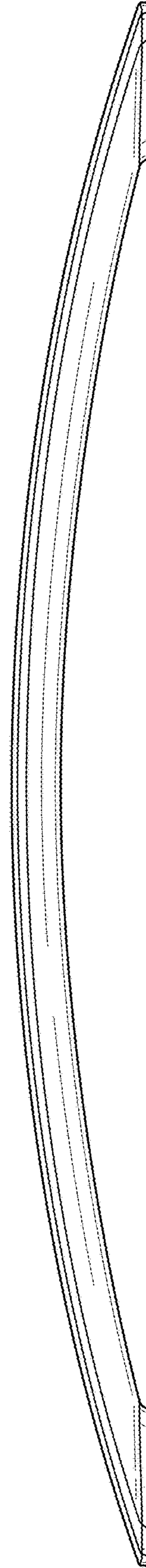

FIG. 5

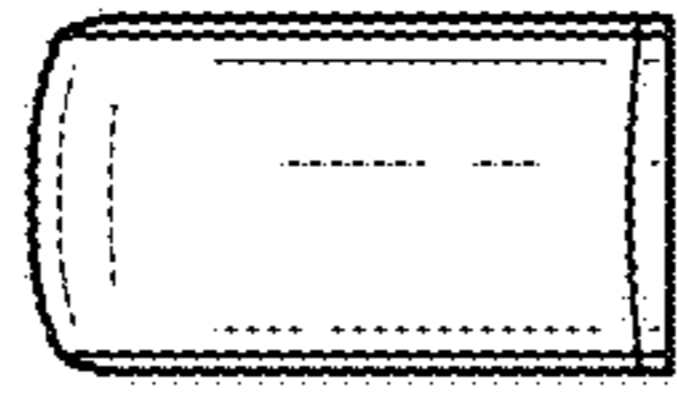

FIG. 6

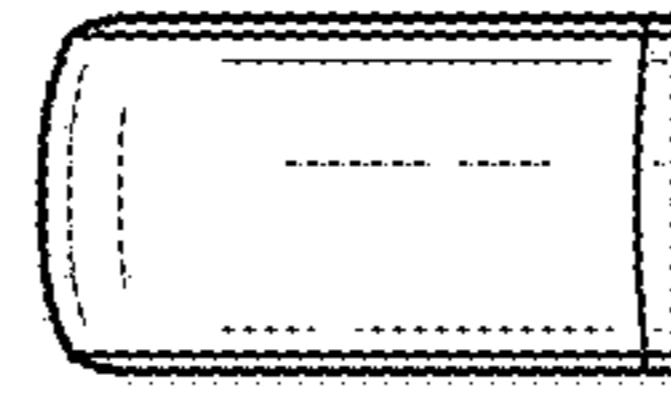

FIG. 7

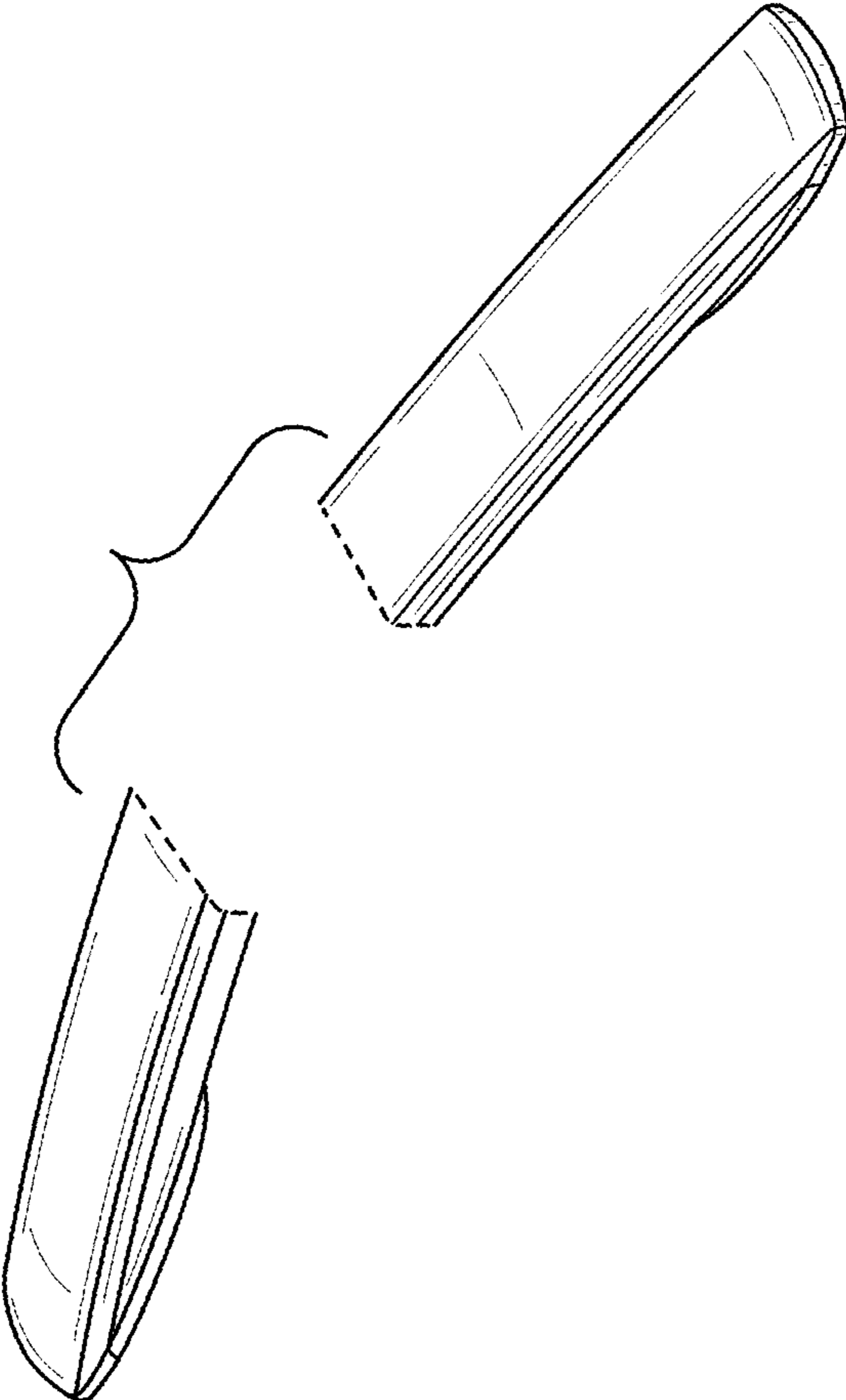

FIG. 8

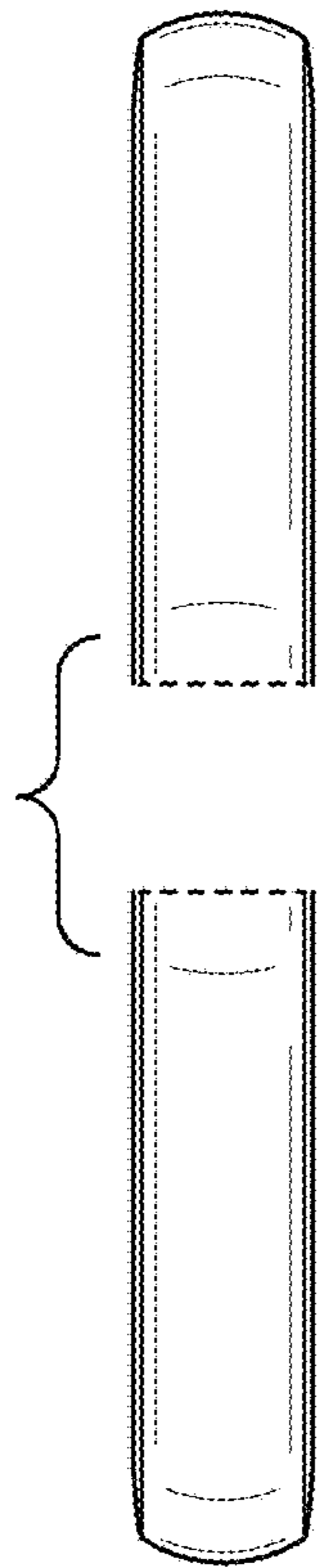

FIG. 9

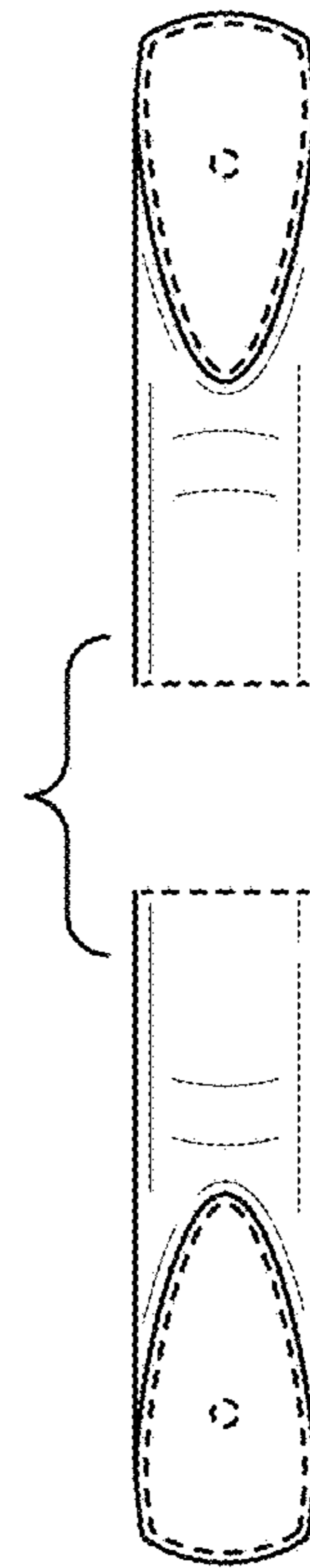

FIG. 10

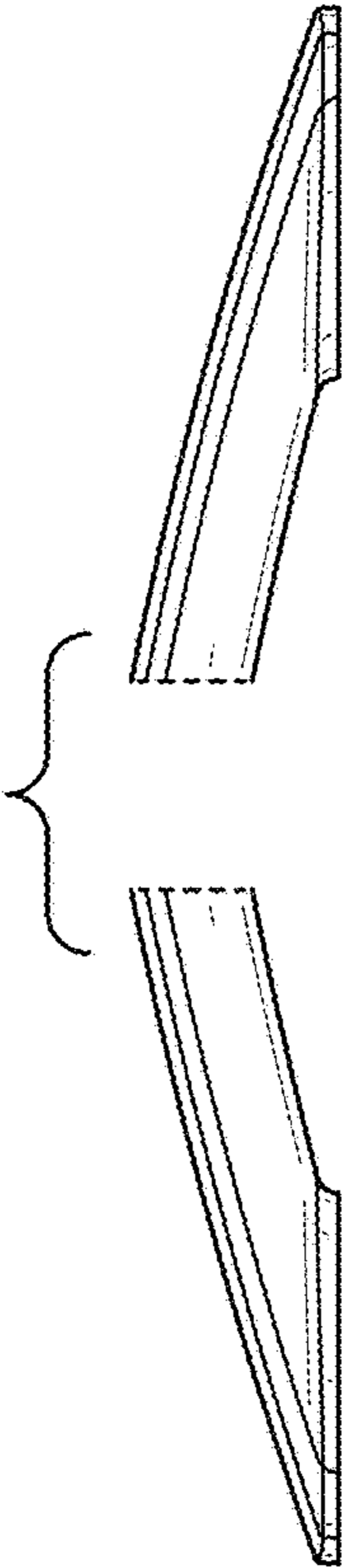

FIG. 11

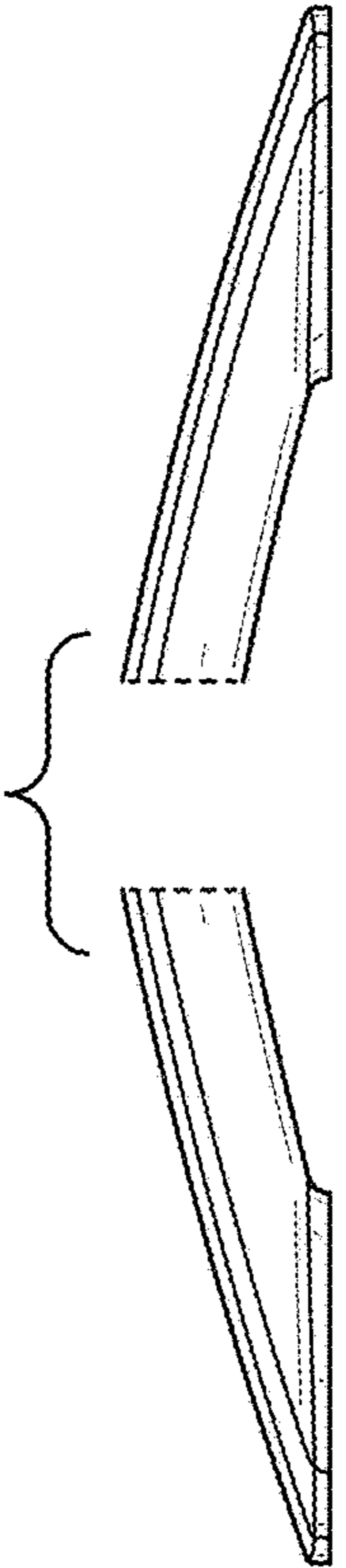

FIG. 12

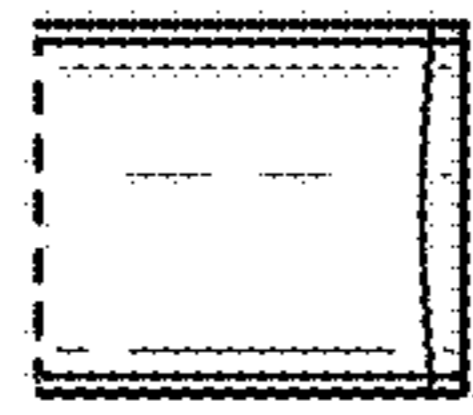

FIG. 13



FIG. 14