



US00D828055S

(12) **United States Design Patent**  
**Chen**

(10) **Patent No.:** **US D828,055 S**

(45) **Date of Patent:** **\*\* Sep. 11, 2018**

(54) **PILLOW HAVING A TRANSPARENT  
POCKET**

(71) Applicant: **Henry Chen**, Westbury, NY (US)

(72) Inventor: **Henry Chen**, Westbury, NY (US)

(\*\*) Term: **15 Years**

(21) Appl. No.: **29/650,370**

(22) Filed: **Jun. 6, 2018**

(51) **LOC (11) Cl.** ..... **06-09**

(52) **U.S. Cl.**  
USPC ..... **D6/601**

(58) **Field of Classification Search**

USPC ..... D6/333, 349, 355, 375, 388, 512, 563,  
D6/564, 595, 596, 601, 604, 611, 707,  
D6/715, 716, 716.1, 603; D24/183-185,  
D24/234; D21/803, 804, 805, 809;  
5/401, 420, 600, 630, 631, 632, 633, 635,  
5/636, 638, 639, 646, 652, 652.1, 655,  
5/703, 730; 297/1, 2, 4, 93, 180.11,  
297/195.1, 195.11, 195.13, 393, 397,  
297/452.12, 452.14, 452.15, 452.21,  
297/452.24, 452.26, 452.48, 452.62, 482  
CPC ..... A47G 9/10; A47G 9/1009; A47G 9/1027;  
A47G 9/1045; A47G 9/1063; A47G  
9/1072; A47G 9/1081

See application file for complete search history.

(56) **References Cited**

**U.S. PATENT DOCUMENTS**

1,470,598 A \* 10/1923 Dessau ..... B63C 9/30  
5/636  
D258,035 S 1/1981 Fenwick  
D343,544 S \* 1/1994 Alexander ..... 5/653  
5,367,731 A \* 11/1994 O'Sullivan ..... A47G 9/0253  
5/645

(Continued)

*Primary Examiner* — Michelle E. Wilson

*Assistant Examiner* — Sanjeev Paul

(74) *Attorney, Agent, or Firm* — Mitchell Law PLLC;  
Mitchell W. Mitchell

(57) **CLAIM**

The ornamental design for a pillow having a transparent pocket, as shown and described.

**DESCRIPTION**

FIG. 1 is a front isometric view of a first embodiment of the pillow having a transparent pocket of the present invention; FIG. 2 is a front view thereof; FIG. 3 is a rear view thereof; FIG. 4 is a left-side view thereof; FIG. 5 is a right-side view thereof; FIG. 6 is a top view thereof; FIG. 7 is a bottom view thereof; FIG. 8 is a front isometric of a second embodiment of the pillow having a transparent pocket showing a rectangular-shaped pocket; FIG. 9 is a front view thereof; FIG. 10 is a front isometric of a third embodiment of the pillow having a transparent pocket showing a circular-shaped pocket; FIG. 11 is a front view thereof; FIG. 12 is a front isometric of a fourth embodiment of the pillow having a transparent pocket showing a diamond-shaped pocket; FIG. 13 is a front view thereof; FIG. 14 is a front isometric of a fifth embodiment of the pillow having a transparent pocket showing an oval-shaped pocket; and, FIG. 15 is a front view thereof.

The broken lines around the transparent pocket represents stitching and are part of the design. The broken lines showing various patches within the transparent pockets are include for the purpose of illustrating environmental subject matter and form no part of the claimed design.

**1 Claim, 15 Drawing Sheets**

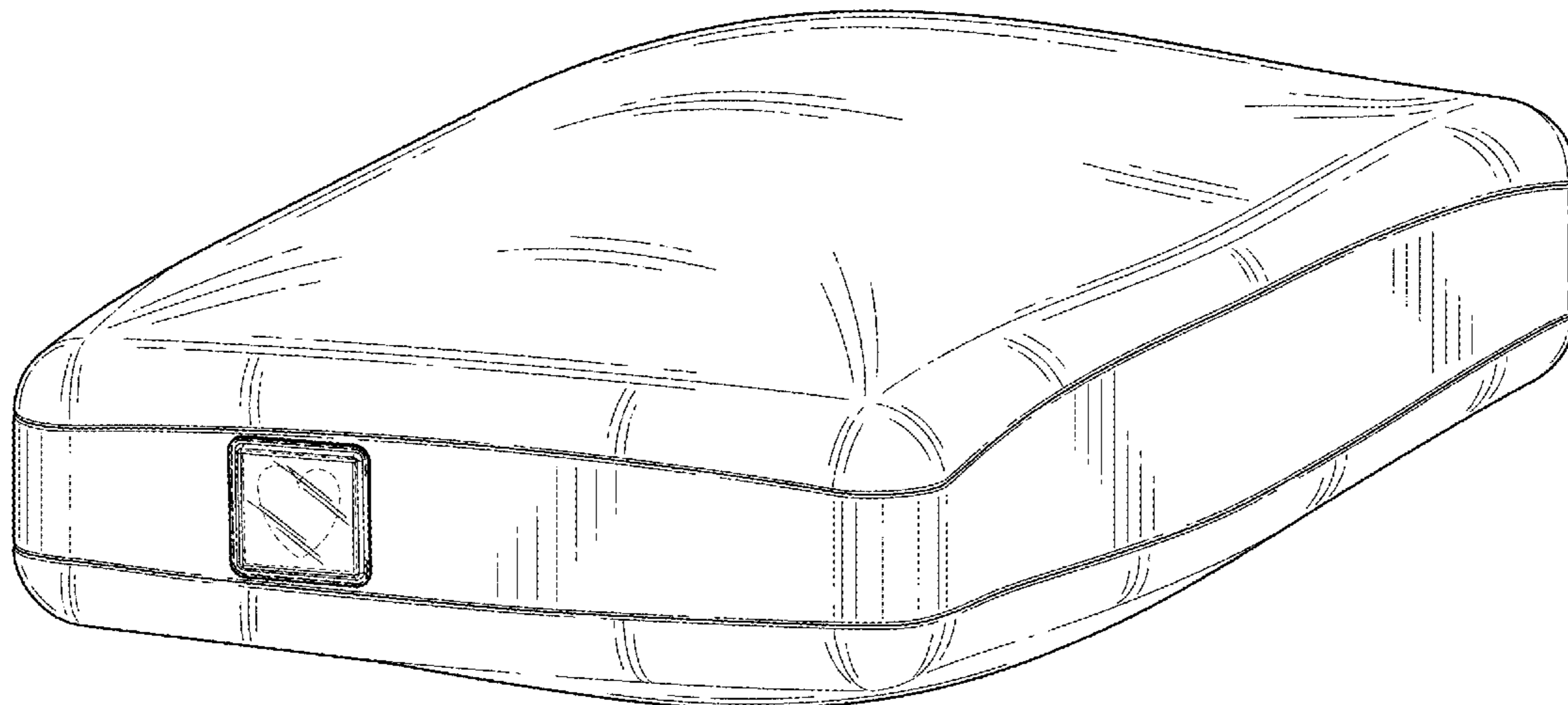



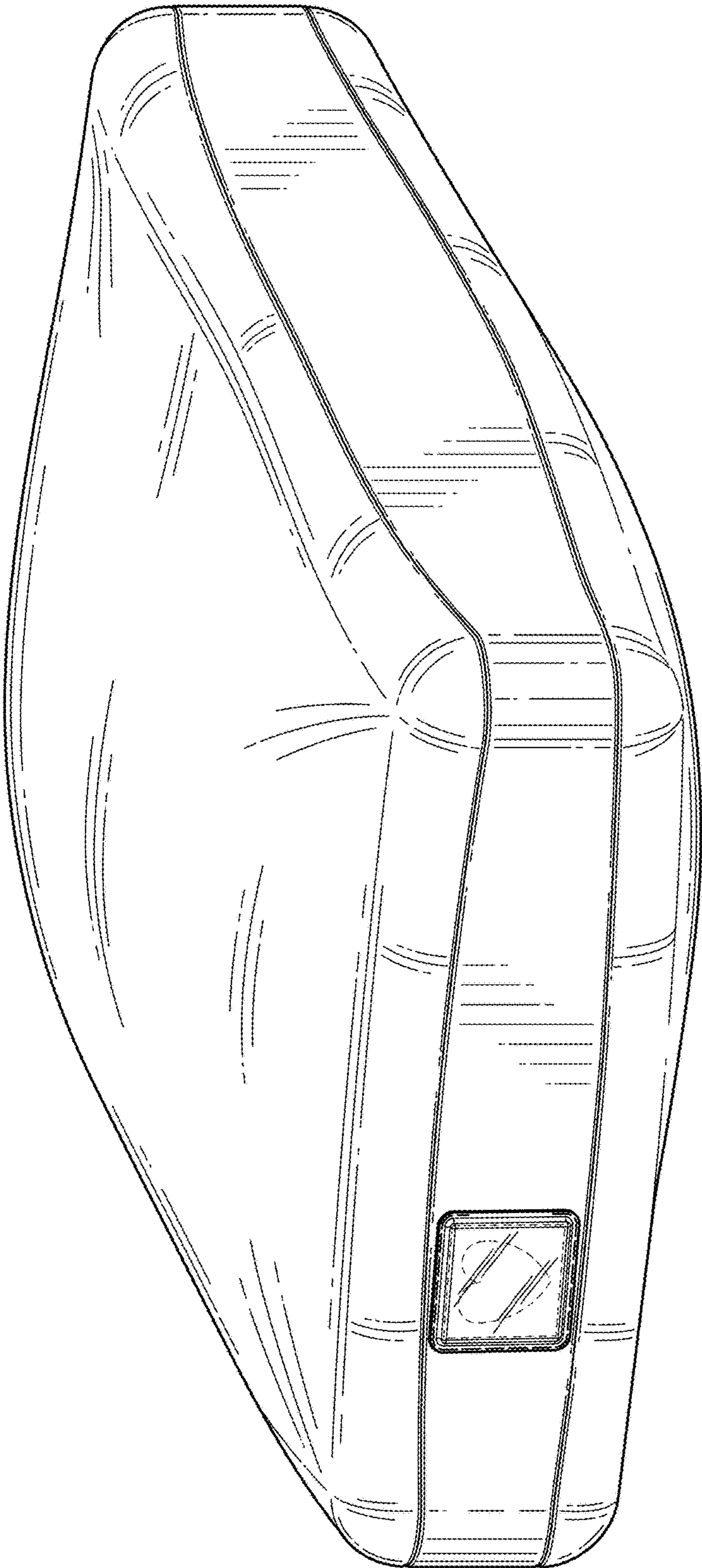

FIG. 1

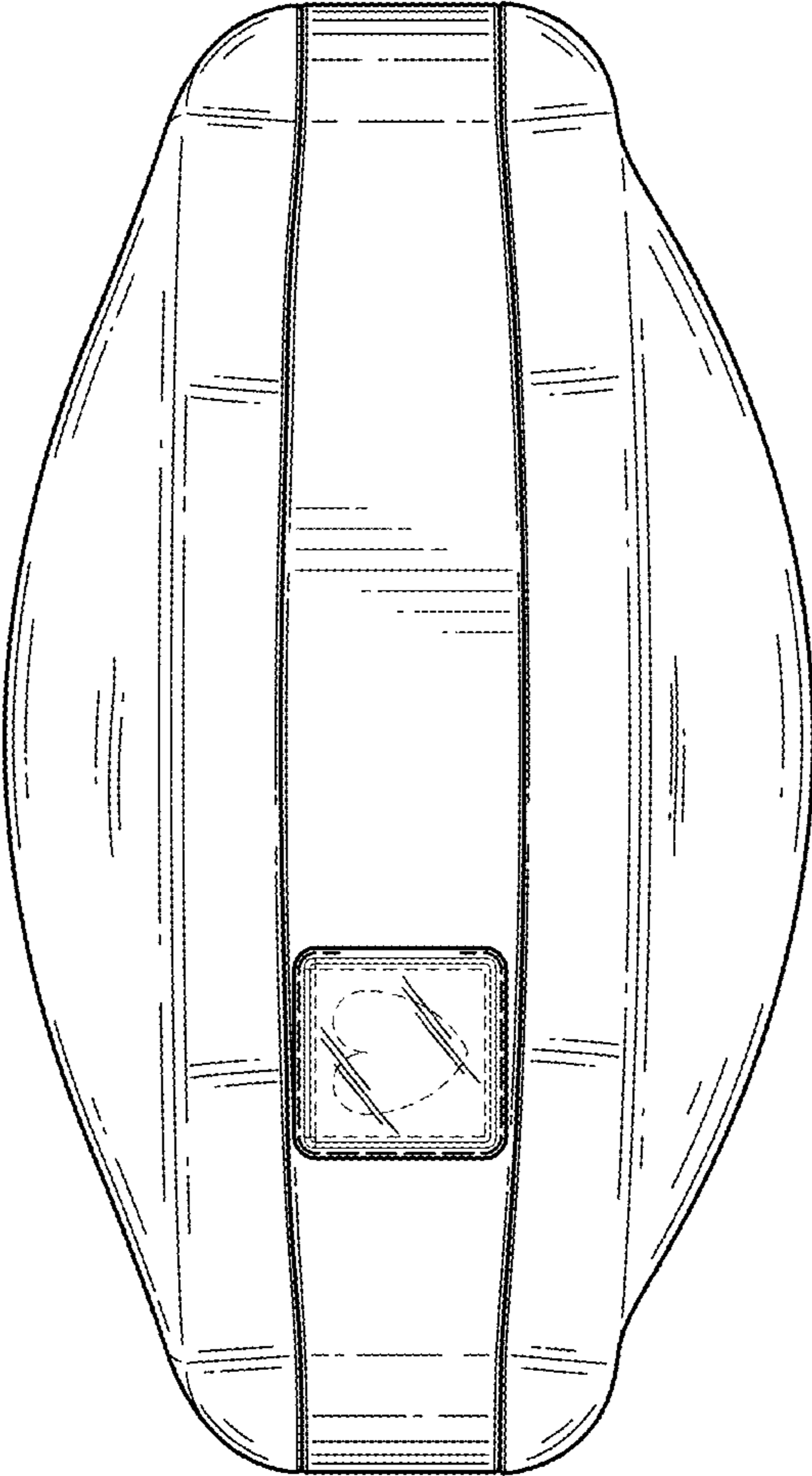

FIG. 2



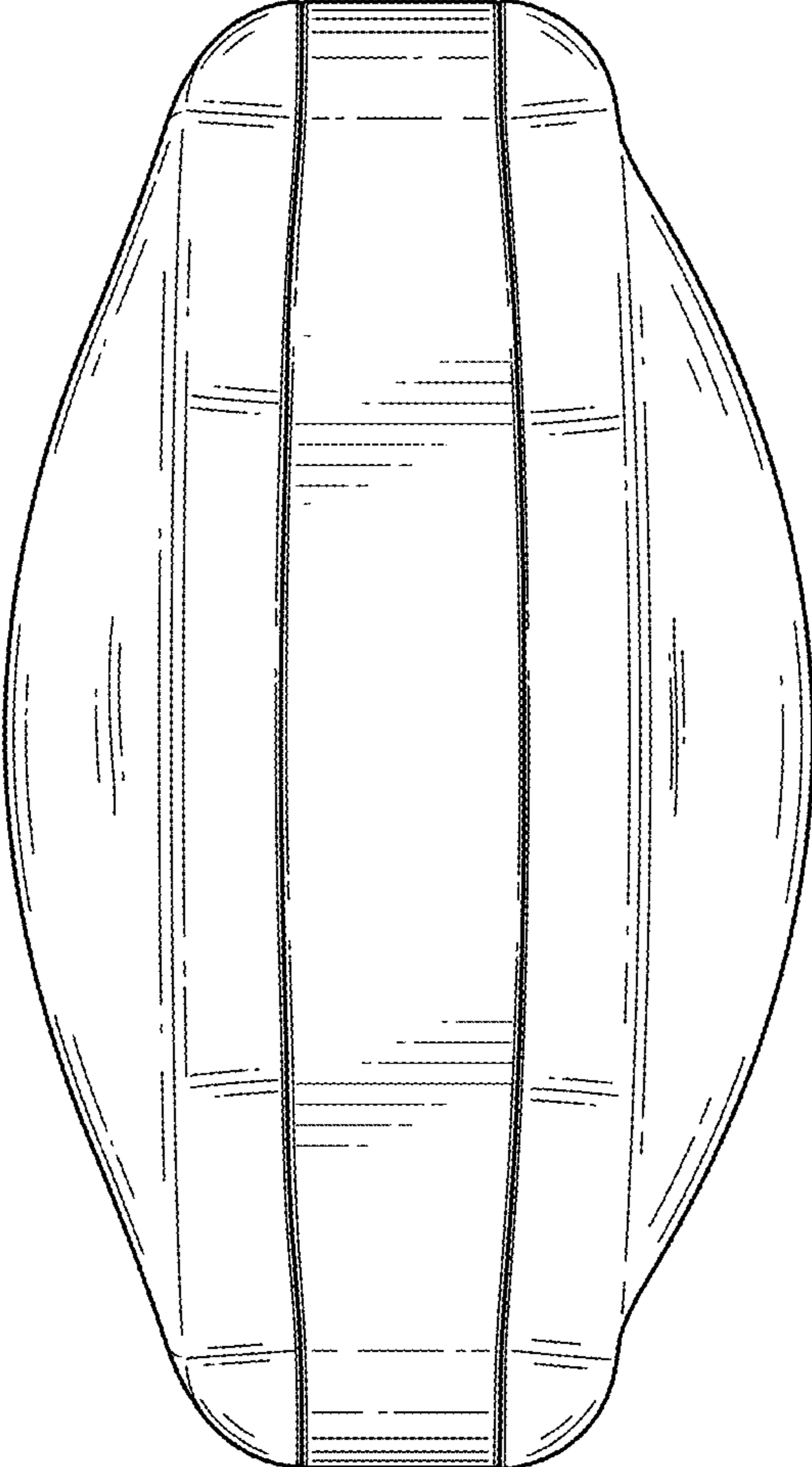

FIG. 3

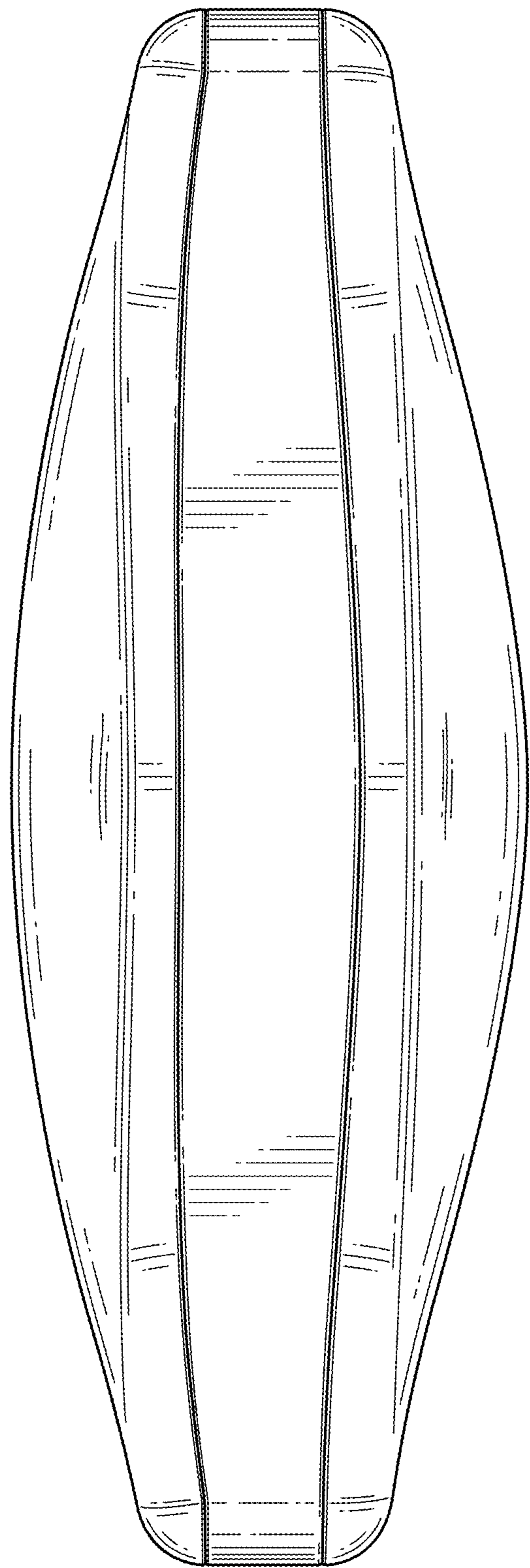

FIG. 4

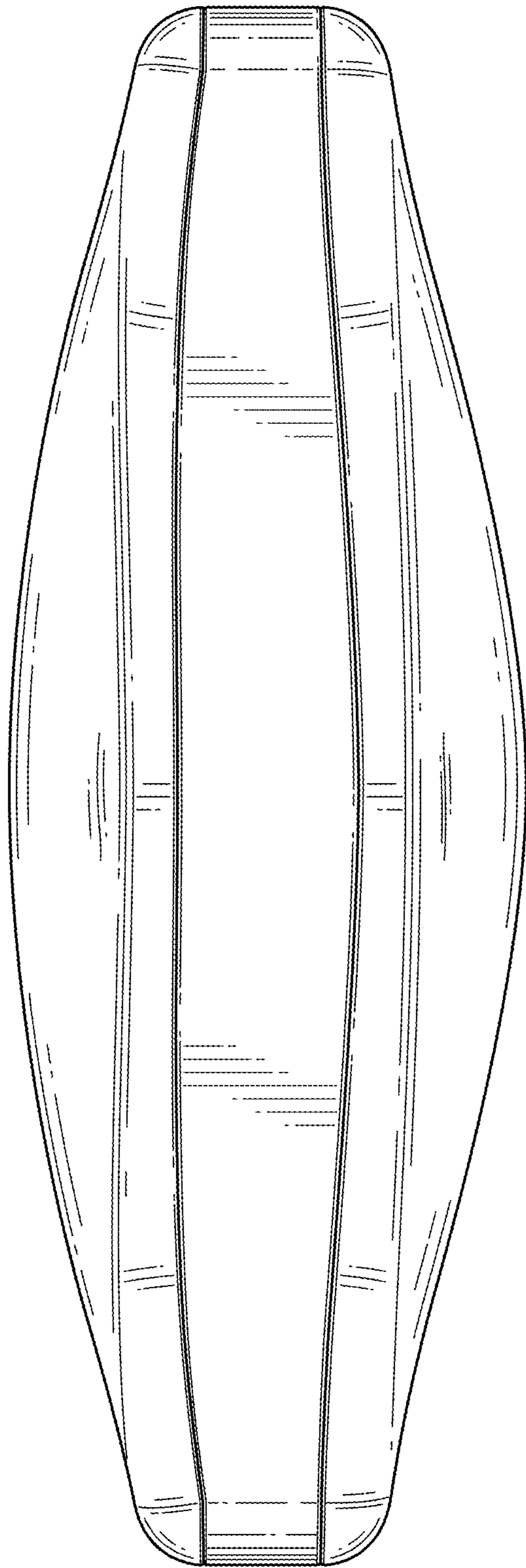

FIG. 5

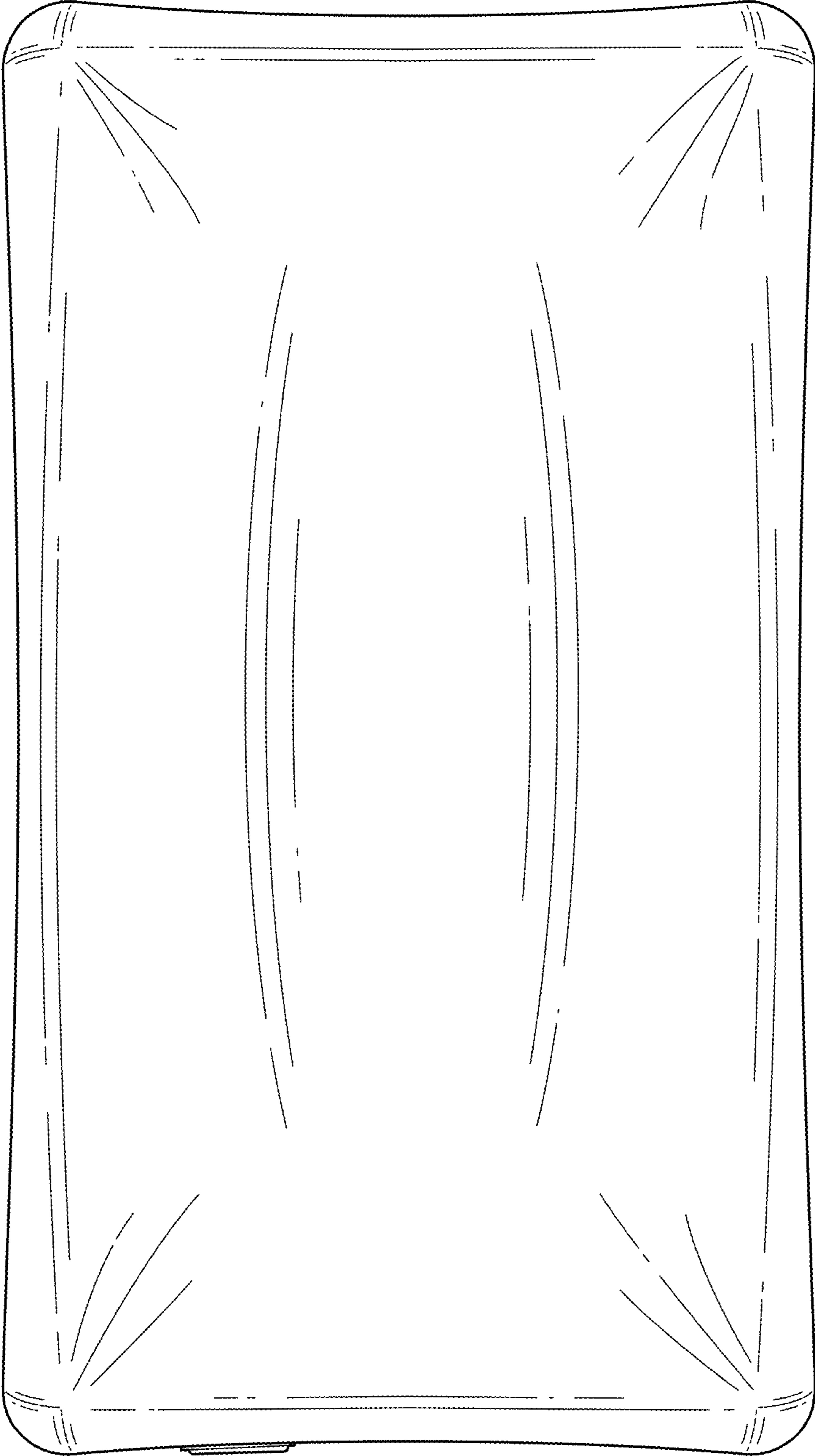

FIG. 6



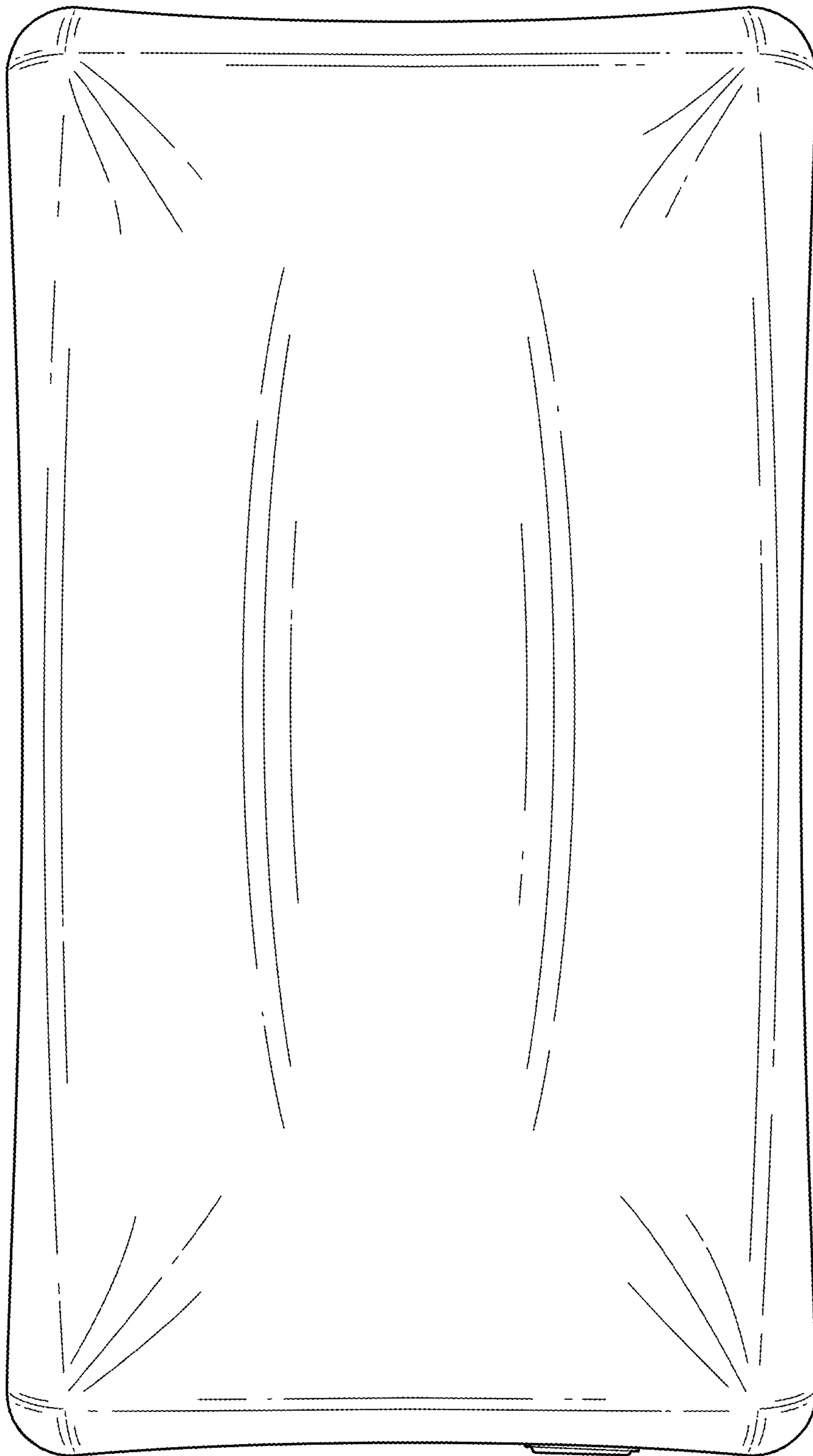

FIG. 7

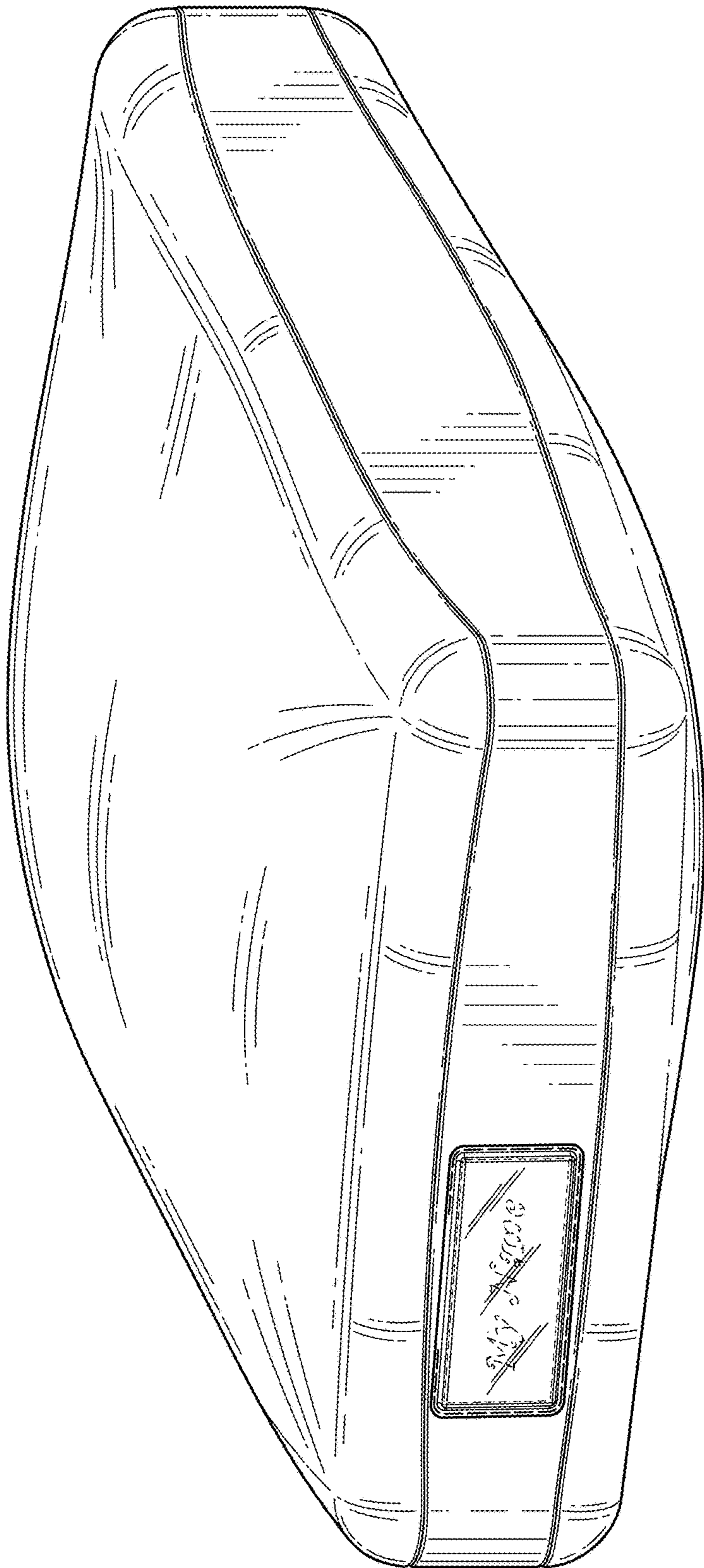

FIG. 8

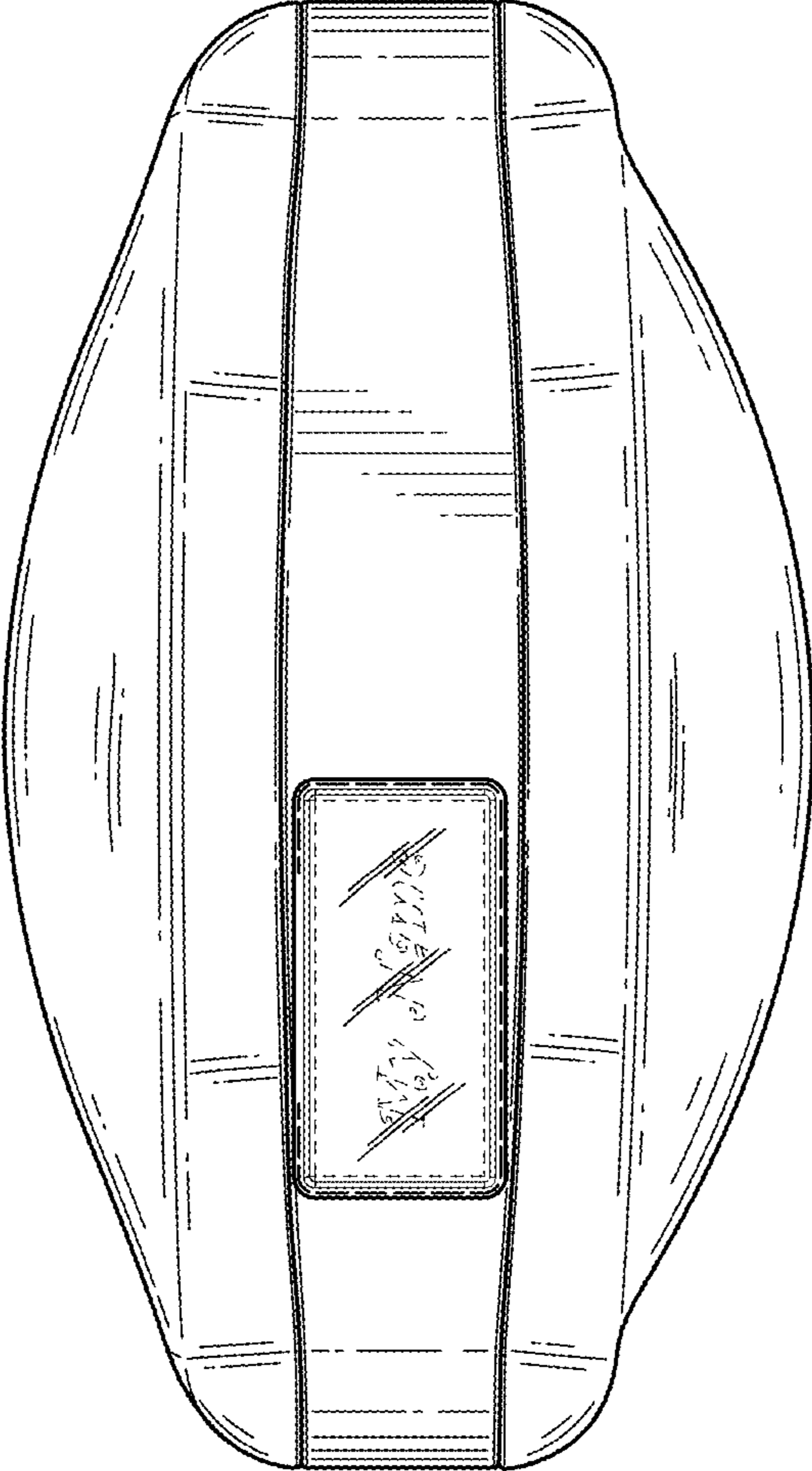

FIG. 9

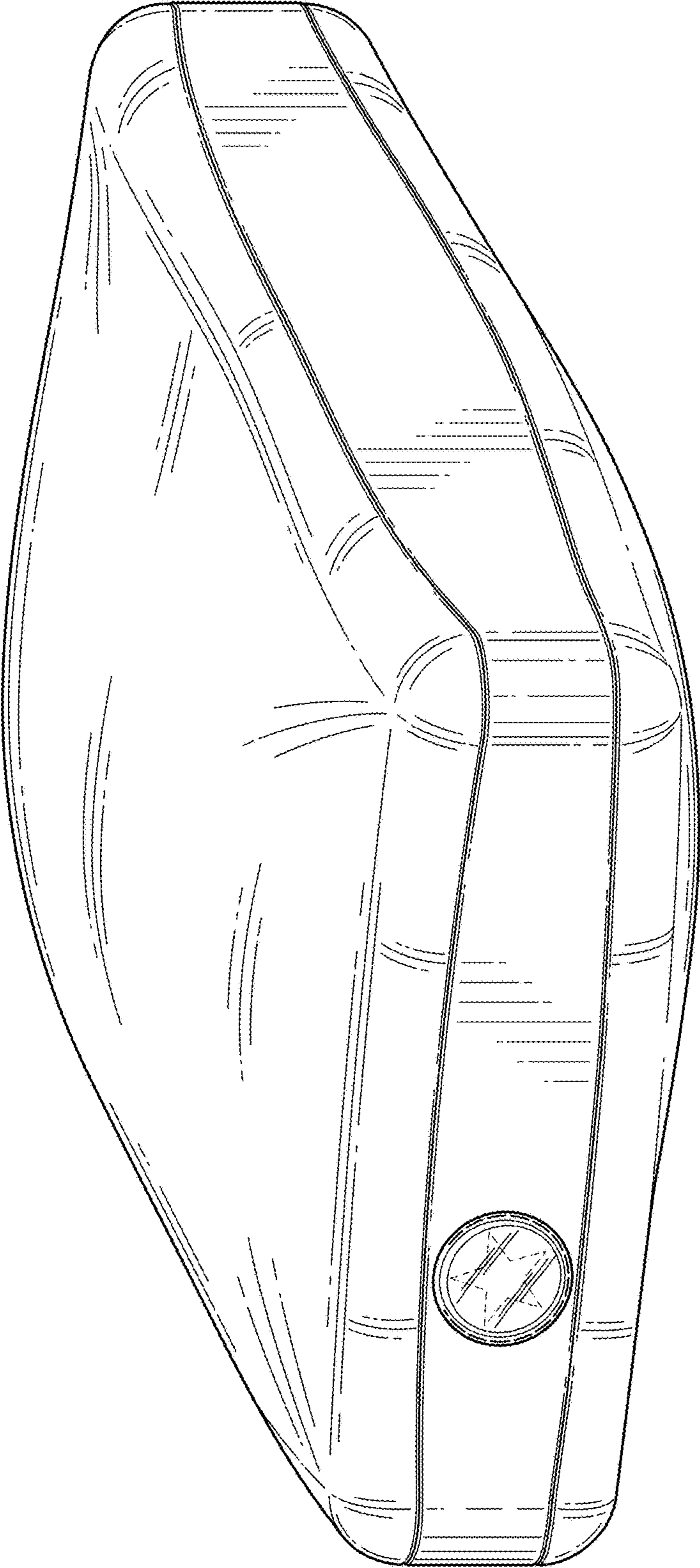

FIG. 10

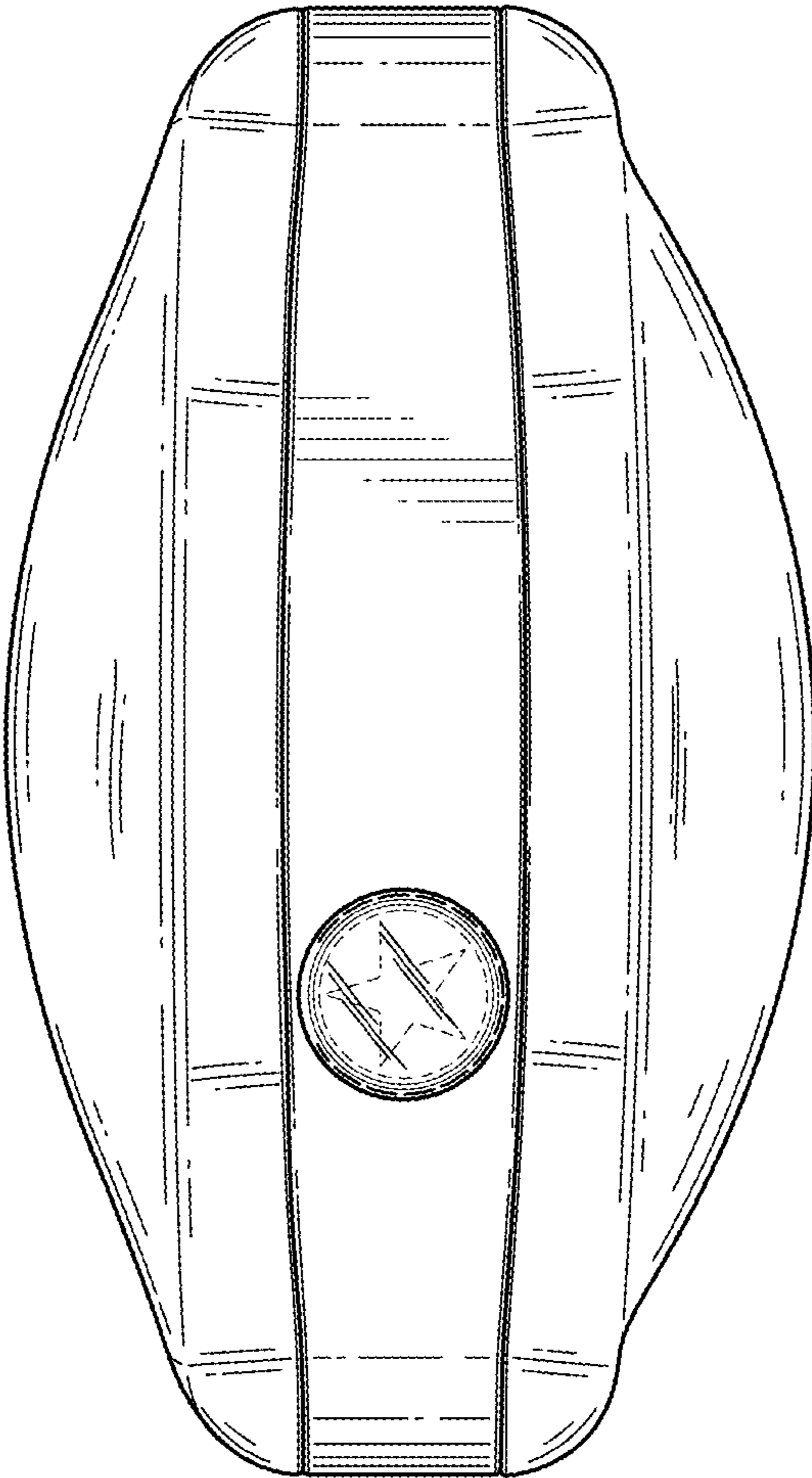

FIG. 11



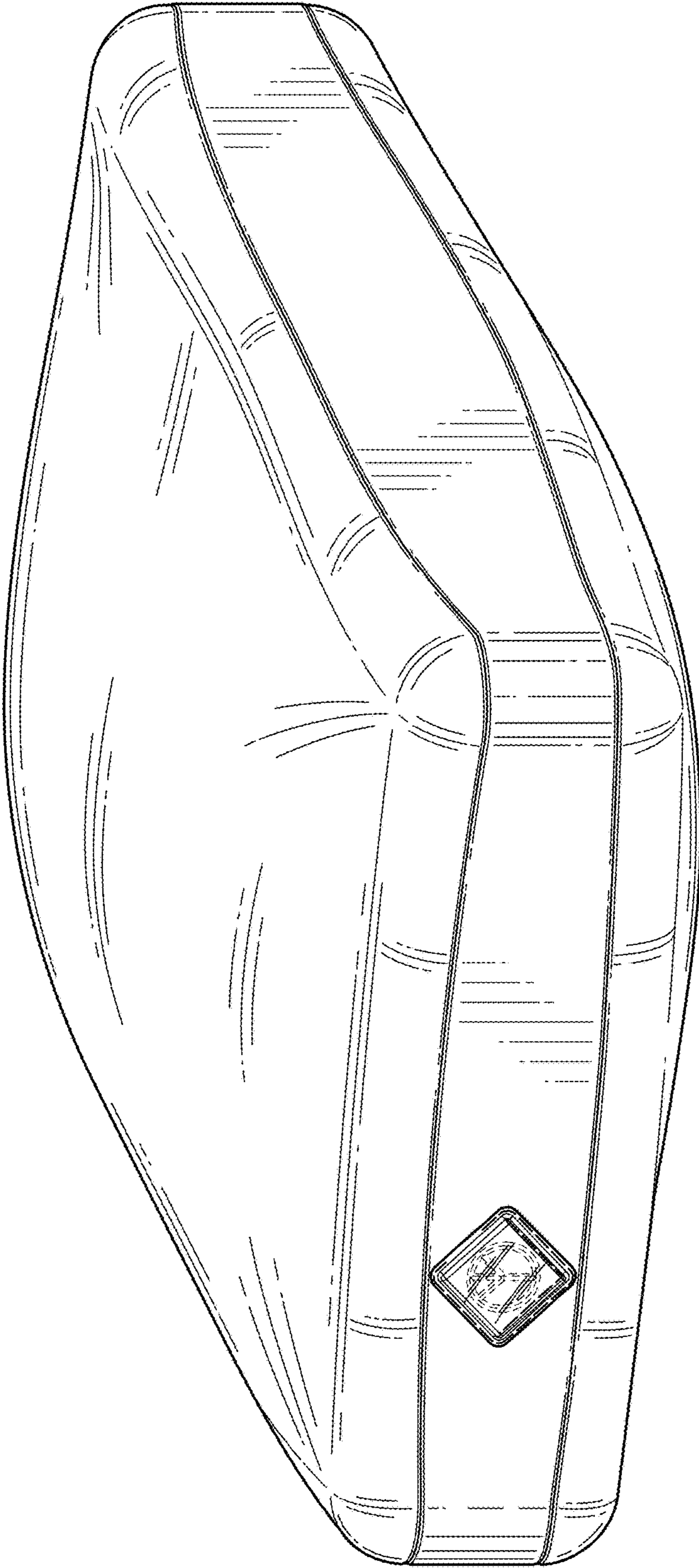

FIG. 12

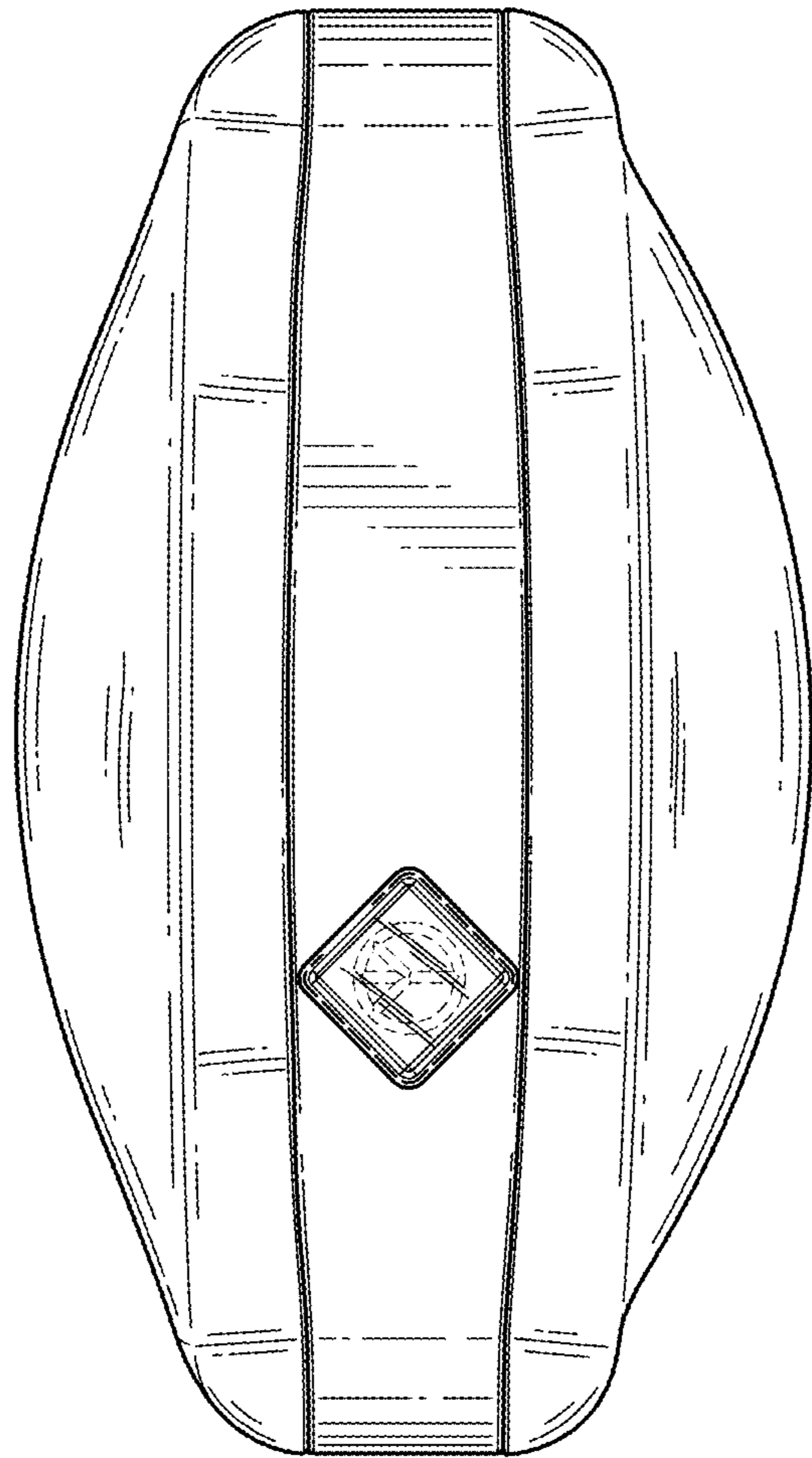

FIG. 13

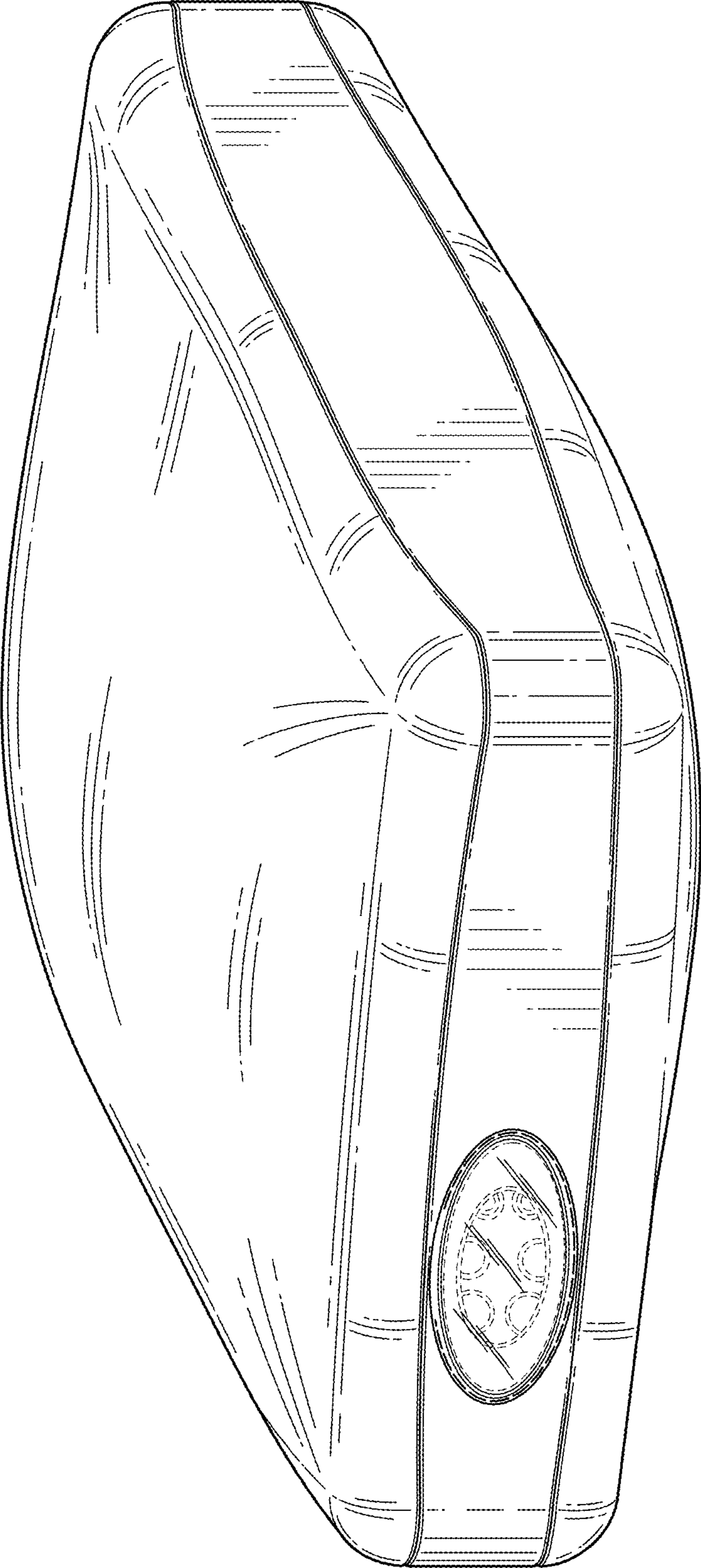

FIG. 14

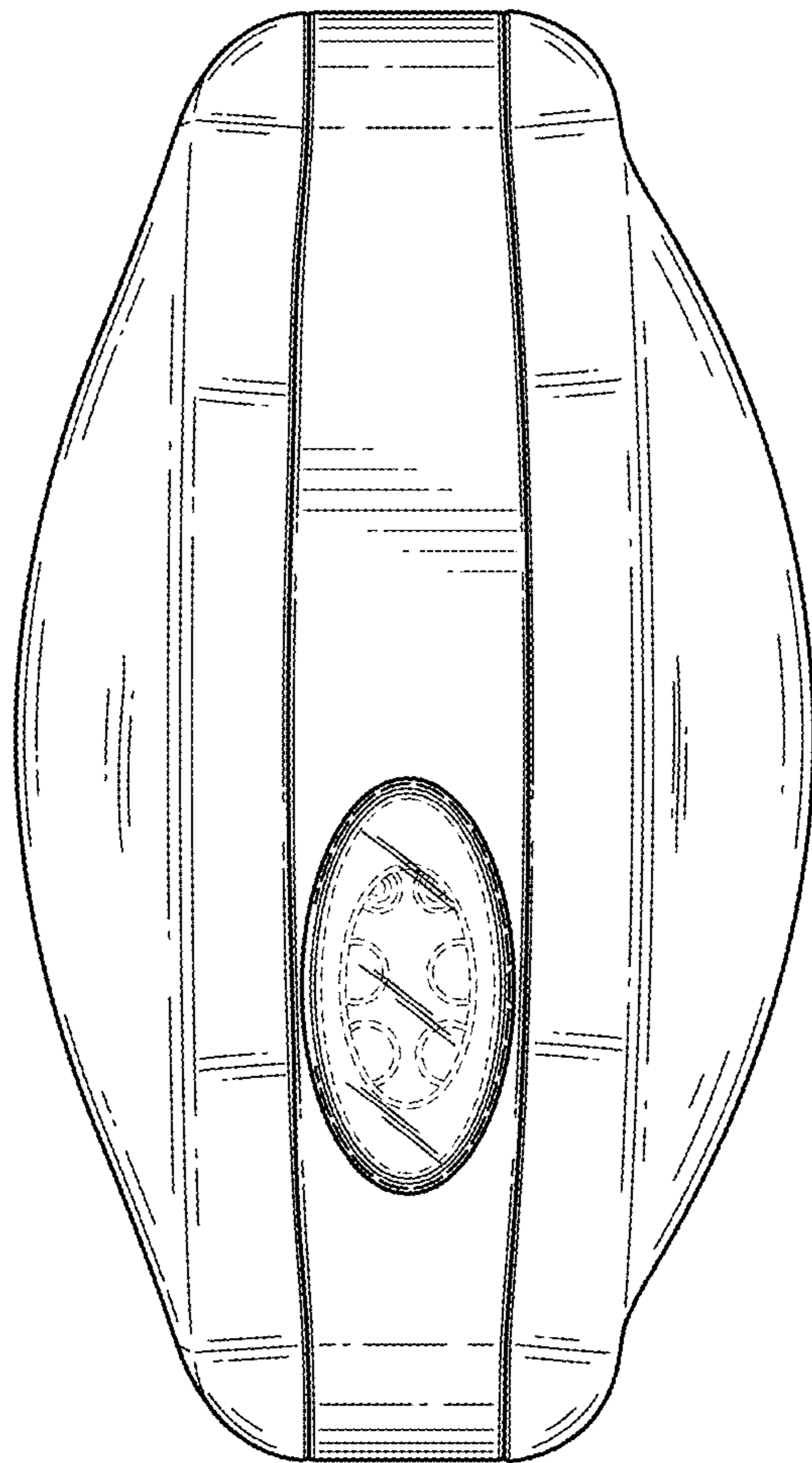

FIG. 15