



US00D828047S

(12) **United States Design Patent** (10) **Patent No.:** **US D828,047 S**  
**Edwards** (45) **Date of Patent:** **\*\* Sep. 11, 2018**

(54) **TOILET FOOTREST FOR CHILDREN**

D695,032 S \* 12/2013 Buitendag ..... D6/349  
D744,174 S \* 11/2015 Jones ..... D30/121  
D784,724 S \* 4/2017 Bunch ..... D6/534  
D800,462 S \* 10/2017 Edwards ..... D6/351

(71) Applicant: **Judy M. Edwards**, St. George, UT  
(US)

(72) Inventor: **Judy M. Edwards**, St. George, UT  
(US)

(\*\*) Term: **15 Years**

(21) Appl. No.: **29/618,019**

(22) Filed: **Sep. 18, 2017**

**Related U.S. Application Data**

(63) Continuation of application No. 29/557,146, filed on  
Mar. 7, 2016, now Pat. No. Des. 800,462.

(51) **LOC (11) Cl.** ..... **06-01**

(52) **U.S. Cl.**  
USPC ..... **D6/351**

(58) **Field of Classification Search**  
USPC ..... D6/334, 336–342, 349–353, 355, 358,  
D6/360, 364–365, 406.2, 574, 596–597,  
D6/601, 604, 688.24–688.27, 691–691.9,  
D6/692–692.6, 716–716.1  
CPC ..... A47C 16/02–16/04; A47C 13/00; A47K  
17/02; A47K 17/028  
See application file for complete search history.

(56) **References Cited**

**U.S. PATENT DOCUMENTS**

D268,148 S \* 3/1983 Appel ..... D6/335  
D362,727 S \* 9/1995 Wilcox ..... D25/65  
D362,728 S \* 9/1995 Wilcox ..... D25/65  
5,547,412 A \* 8/1996 Wilcox ..... A63H 3/003  
108/50.02  
D501,683 S \* 2/2005 Hernandez ..... D25/65  
D507,662 S \* 7/2005 St-Hilaire ..... D25/63  
D608,101 S \* 1/2010 Coute ..... D6/338  
D623,808 S \* 9/2010 Weber ..... D30/199  
D630,864 S \* 1/2011 Perelman ..... D6/351

**OTHER PUBLICATIONS**

Fisher Price—Precious Planet Hop On Hippo Step Stool. [online]  
Retrieved Jun. 12, 2017 from URL: <<https://www.walmart.com/ip/FisherPricePreciousPlanetHopOnHippoStepStool/10727395>>.\*

(Continued)

*Primary Examiner* — Vy N Koenig  
(74) *Attorney, Agent, or Firm* — Gurr & Brande, PLLC;  
Robert A. Gurr

(57) **CLAIM**

The ornamental design for a toilet footrest for children, as  
shown and described.

**DESCRIPTION**

FIG. 1 is a front perspective view of the toilet footrest for  
children;  
FIG. 2 is a front elevation view of the toilet footrest for  
children;  
FIG. 3 is a left side elevation view of the toilet footrest for  
children;  
FIG. 4 is a right side elevation view of the toilet footrest for  
children  
FIG. 5 is a back elevation view of the toilet footrest for  
children;  
FIG. 6 is a top plan view of the toilet footrest for children;  
and,  
FIG. 7 is a bottom plan view of the toilet footrest for  
children.  
The broken lines shown in the drawings are for the purpose  
of illustrating portions of the article that form no part of the  
claimed design.

**1 Claim, 5 Drawing Sheets**

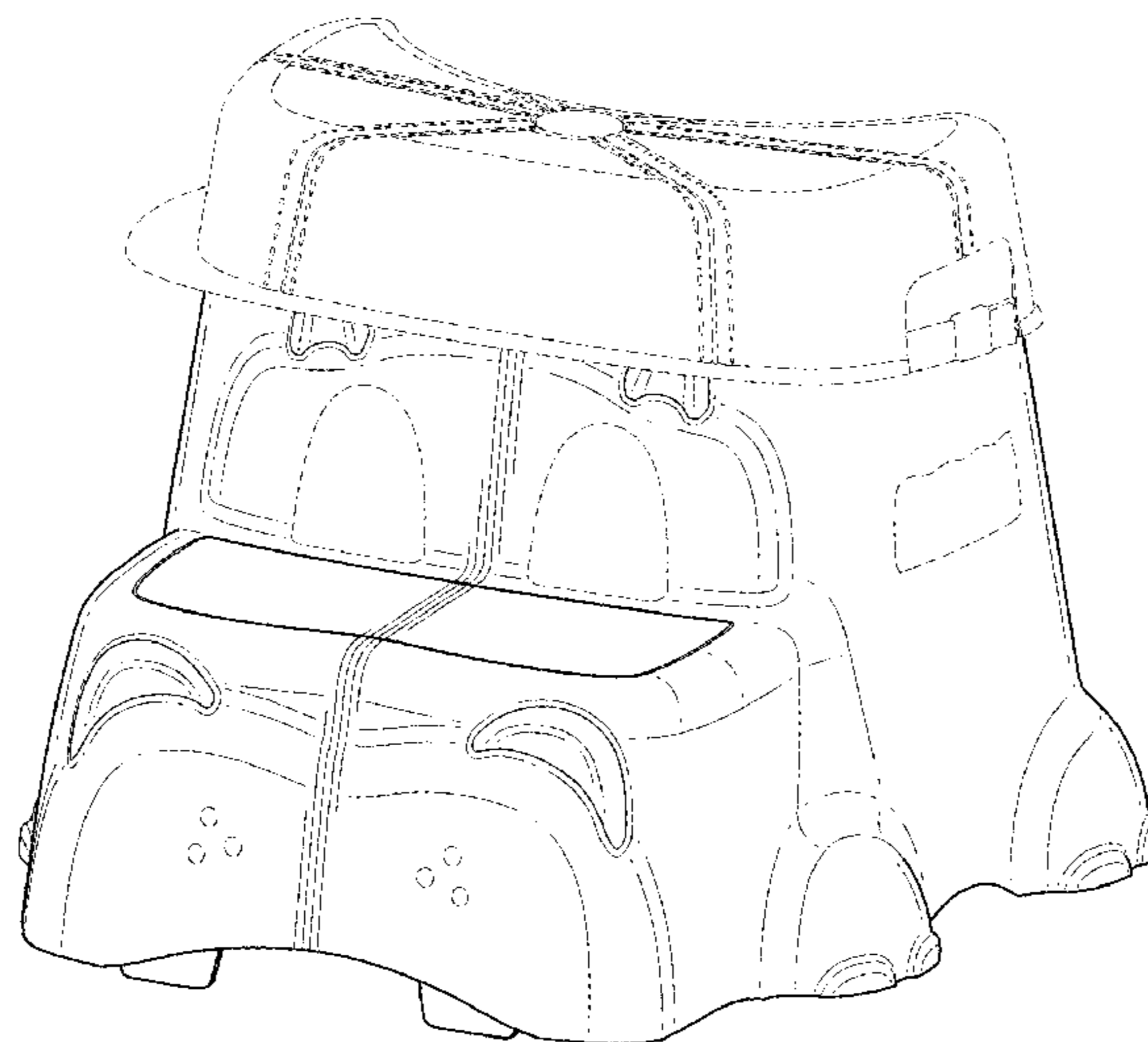

(56)

**References Cited**

<<https://www.amazon.co.uk/PiecePurpleBathtubToiletDiaper/dp/B00VVGPMN2>>.\*

OTHER PUBLICATIONS

SquattyPottymus. [online] Retrieved Jun. 6, 2018 from URL: <<https://www.squattypotty.com/shop/poop-better/squatty-pottymus/>>.\*

8 Piece Baby Bath Set Hippo Purple Bathtub XXL 100 cm + Bathtub Stand + Bath Seat + Potty + Toilet Seat + Stool, Two Step + Diaper Pail + Wash Mitt. [online] Retrieved from URL:

\* cited by examiner

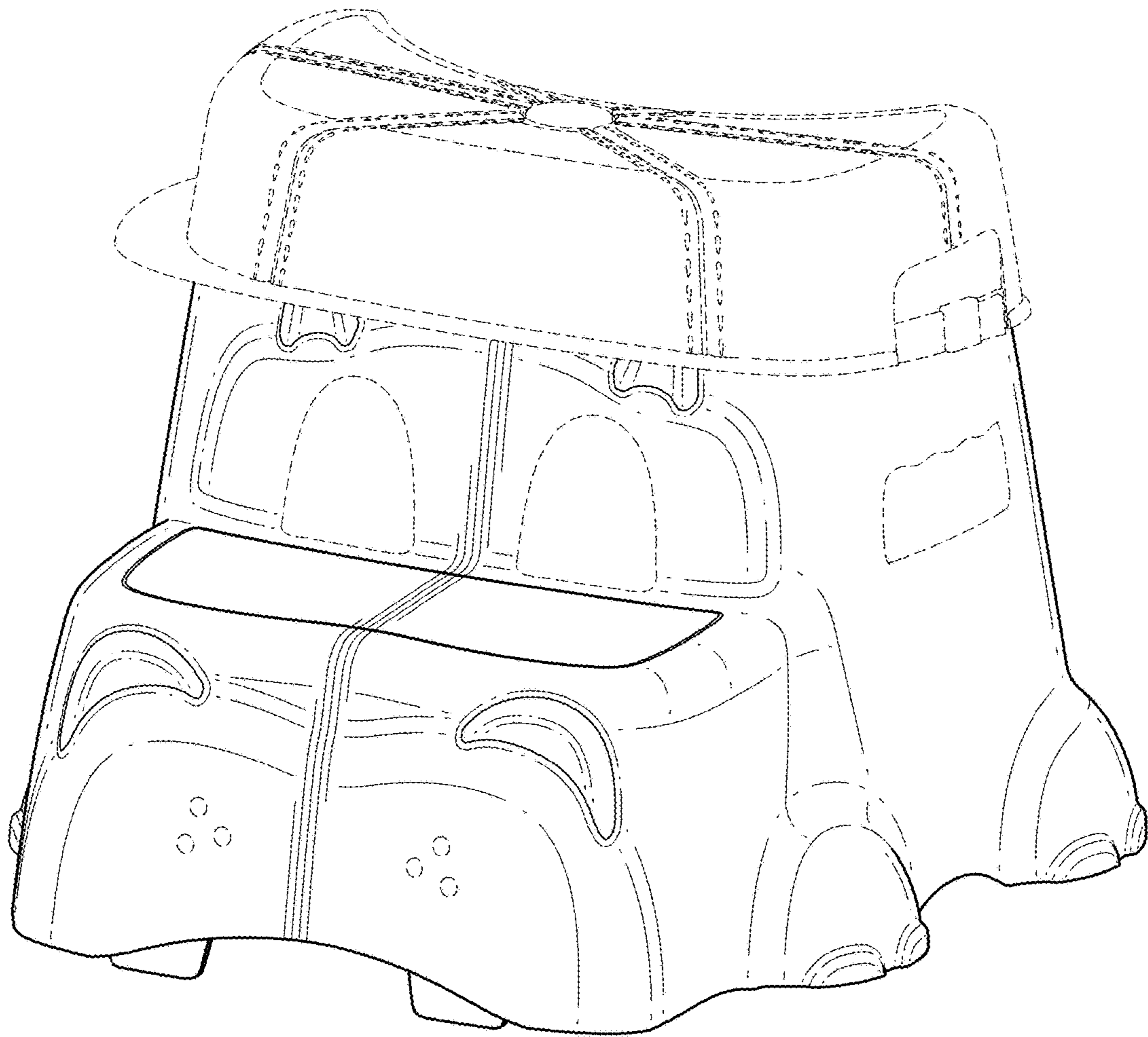

**FIG. 1**

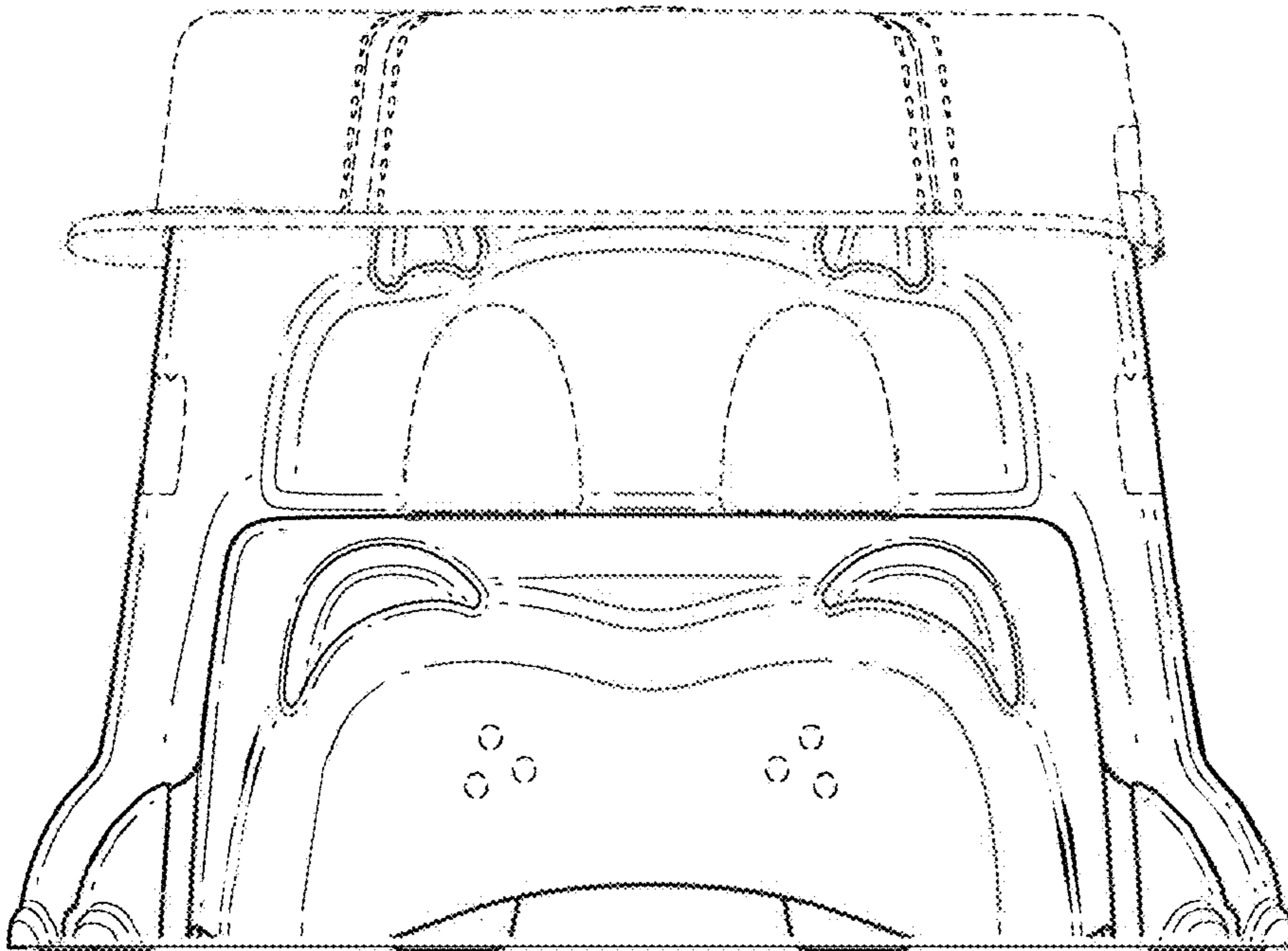

**FIG. 2**

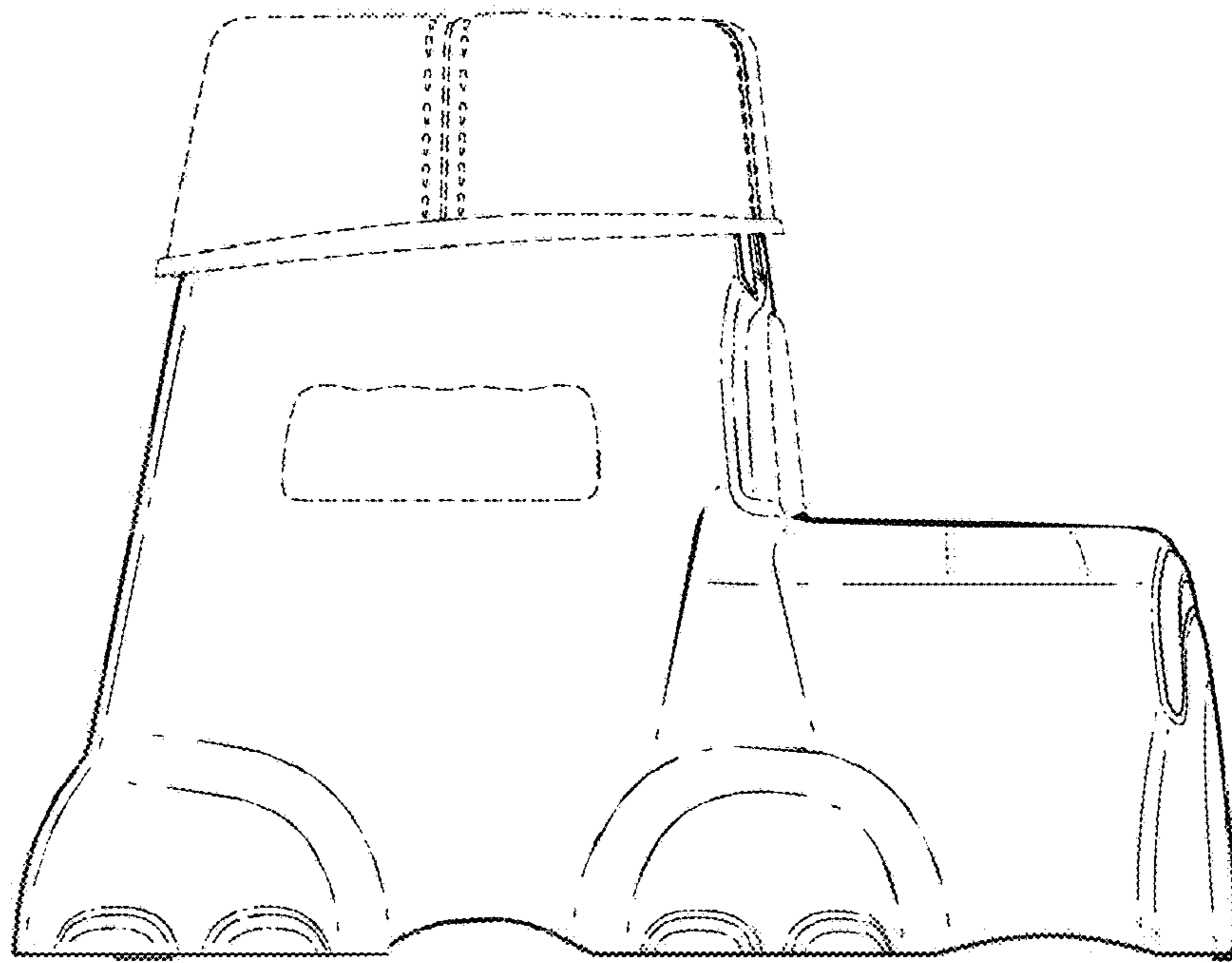

**FIG. 3**

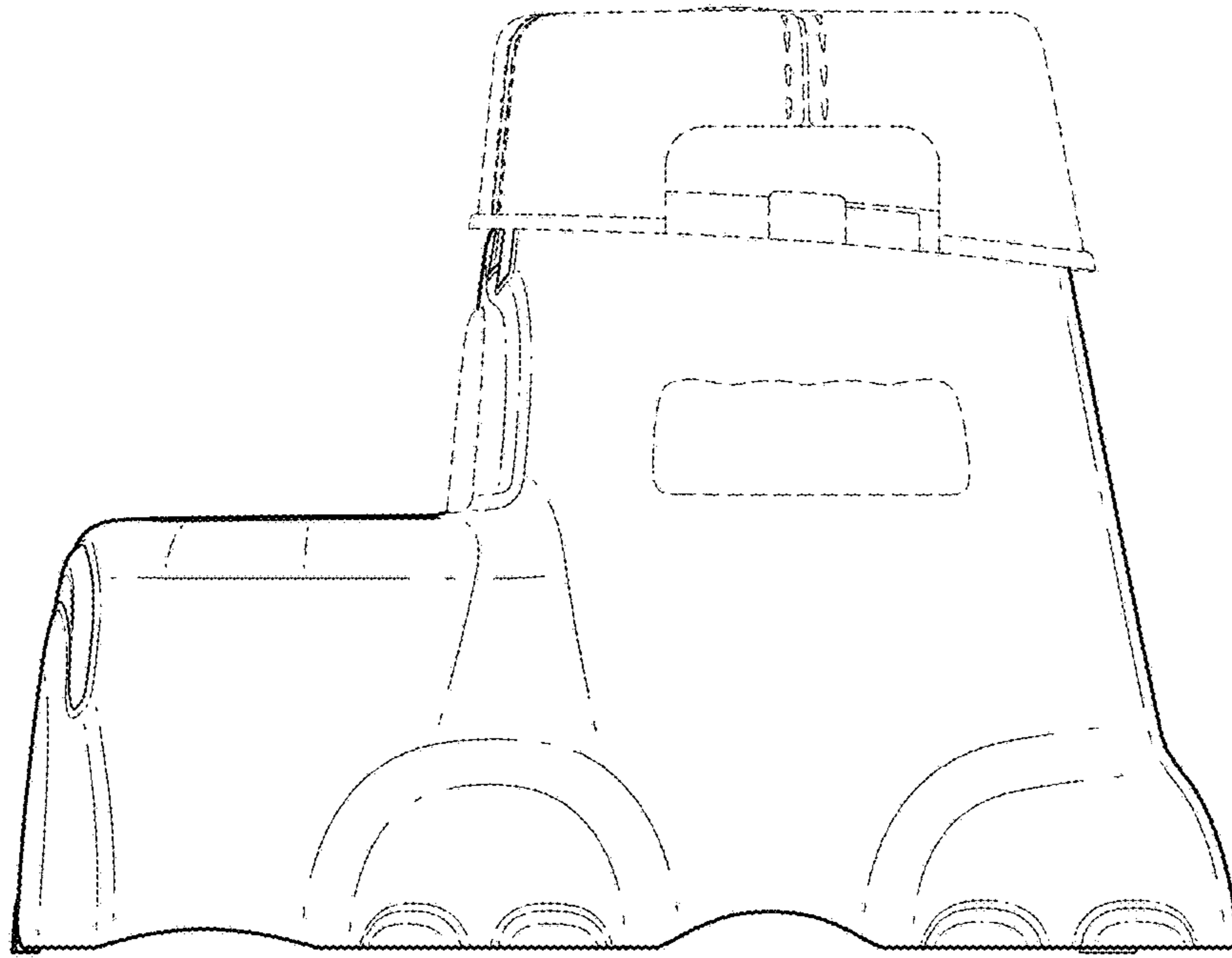

**FIG. 4**

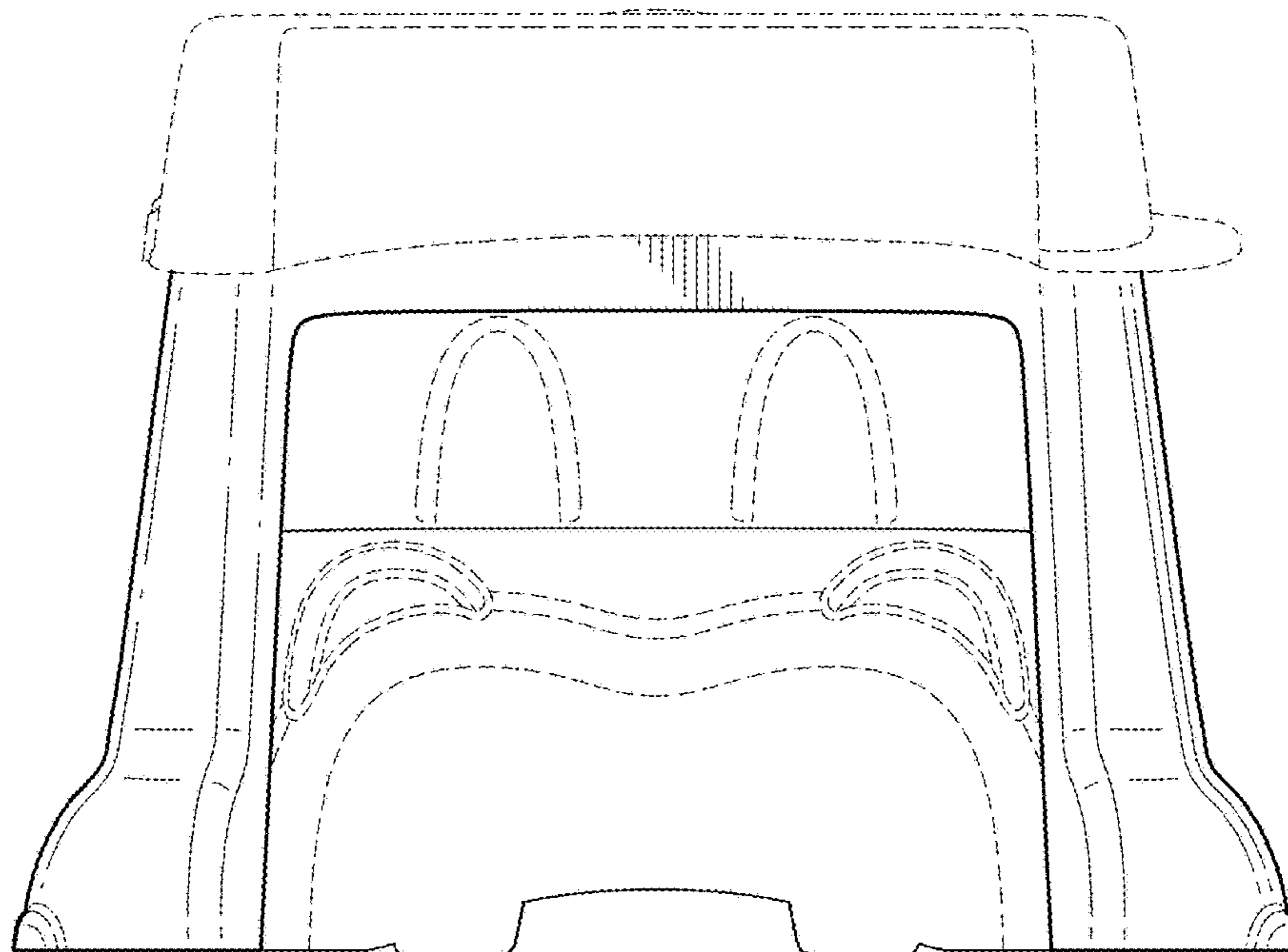

**FIG. 5**

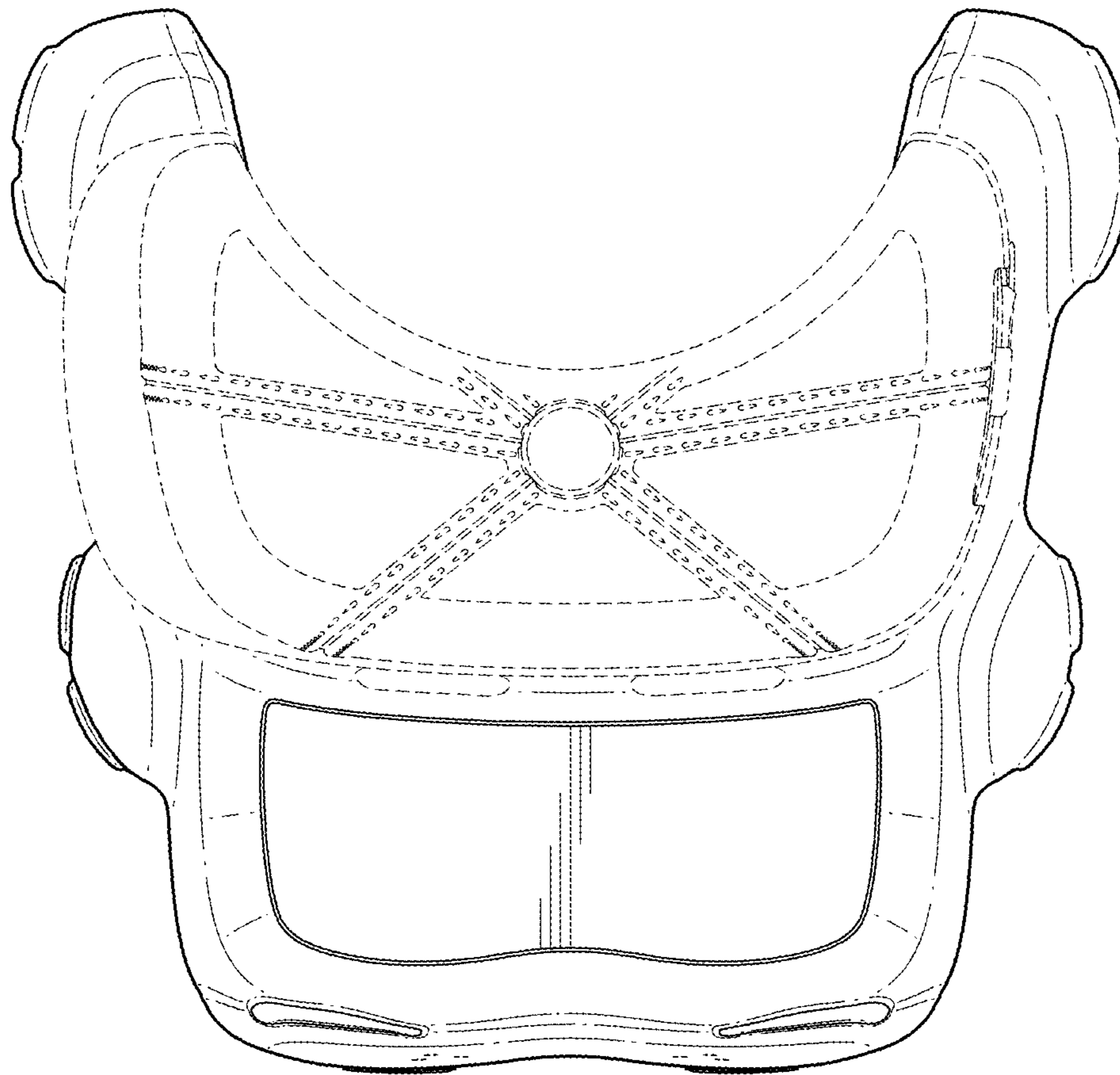

**FIG. 6**

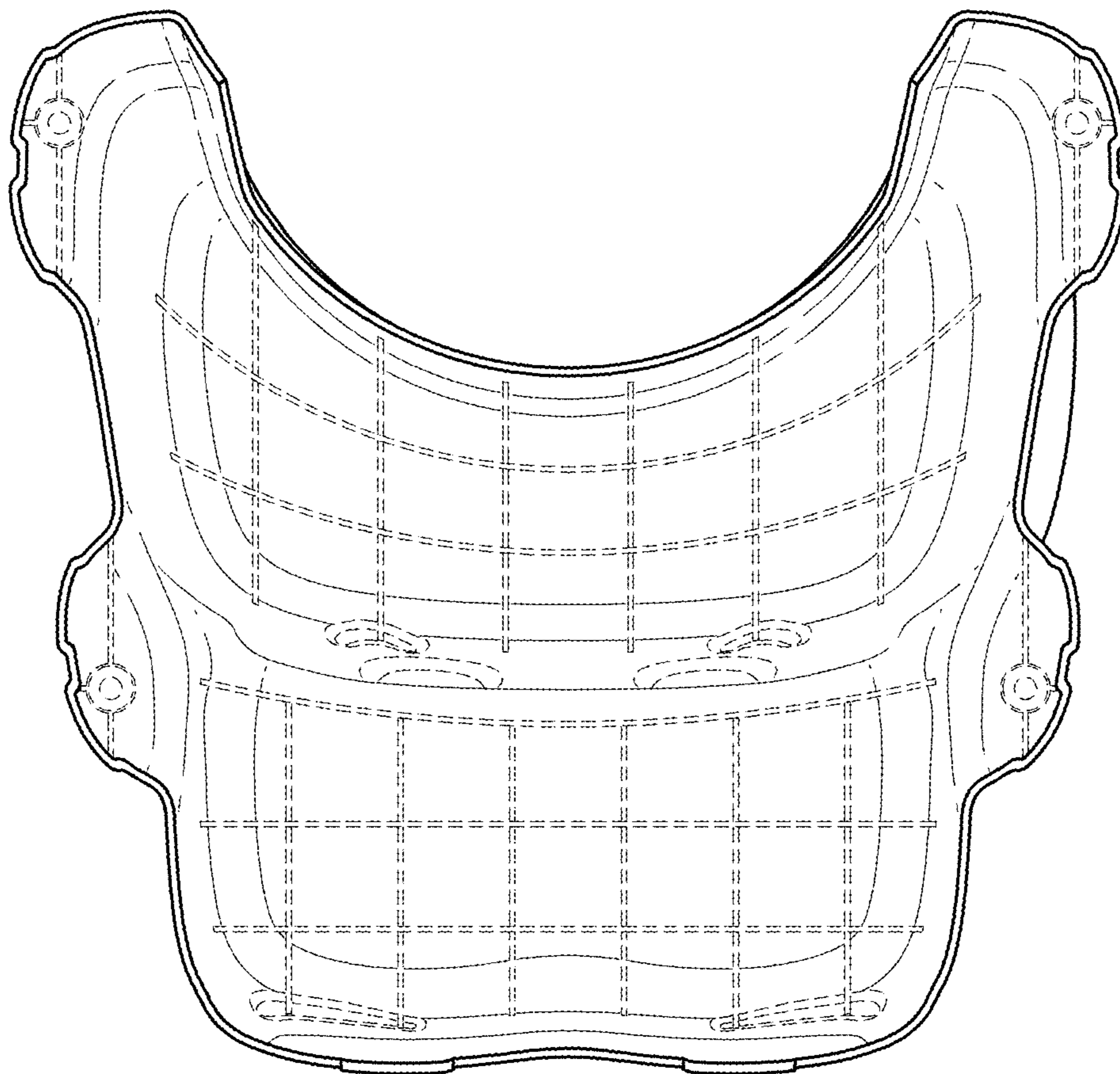

**FIG. 7**