



US00D827996S

(12) **United States Design Patent**  
**Wang et al.**

(10) **Patent No.:** **US D827,996 S**  
(45) **Date of Patent:** **\*\* Sep. 11, 2018**

(54) **SHOE WITH STRAPS AND STUDS**

(71) Applicant: **Alexander Wang Incorporated**, New York, NY (US)

(72) Inventors: **Alexander Wang**, New York, NY (US);  
**Nicolas Jean Berny**, Porto Vecchio (FR)

(73) Assignee: **ALEXANDER WANG INCORPORATED**, New York, NY (US)

(\*\*) Term: **15 Years**

(21) Appl. No.: **29/588,843**

(22) Filed: **Dec. 23, 2016**

(51) **LOC (11) Cl.** ..... **02-04**

(52) **U.S. Cl.**  
USPC ..... **D2/939**

(58) **Field of Classification Search**

USPC ..... D2/896, 900, 916-18, 925-942, 971  
CPC ..... A43B 21/00; A43B 21/02; A43B 21/06;  
A43B 9/14; A43B 1/0045; A43B 13/10;  
A43B 13/12; A43B 23/06; A43B 23/07;  
A43B 1/0036; A43B 5/12; A43B 3/248;  
A43B 9/02; A43B 13/122; A43B 13/14;  
A43B 3/108

See application file for complete search history.

(56) **References Cited**

**U.S. PATENT DOCUMENTS**

D87,274 S *	6/1932	Meyer et al.	.....	D2/930
D90,369 S *	7/1933	Kaminski	.....	D2/935
D91,534 S *	2/1934	Morali	.....	D2/930
D93,485 S *	10/1934	Perugia	.....	D2/931
D94,513 S *	2/1935	Perugia	.....	D2/930
D95,204 S *	4/1935	Haffin	.....	D2/931
D97,677 S *	12/1935	Goldberg	.....	D2/933
D406,444 S *	3/1999	Van Dyke	.....	D2/916

D418,280 S *	1/2000	Kieler	.....	D2/916
D765,954 S *	9/2016	Sassi	.....	D2/929
D766,557 S *	9/2016	Sassi	.....	D2/929

(Continued)

*Primary Examiner* — Dominic V Simone

(74) *Attorney, Agent, or Firm* — Arent Fox LLP

(57) **CLAIM**

What is claimed is a shoe with straps and studs, as shown and described.

**DESCRIPTION**

FIG. 1 is a perspective view of a shoe with straps and studs; FIG. 2 is a front view thereof; FIG. 3 is a rear view thereof; FIG. 4 is a left side view thereof; FIG. 5 is a right side view thereof; FIG. 6 is a top view thereof; FIG. 7 is a bottom view thereof; FIG. 8 is a perspective view of another shoe with straps and studs; FIG. 9 is a front view of the shoe shown in FIG. 8; FIG. 10 is a rear view of the shoe shown in FIG. 8; FIG. 11 is a right side view of the shoe shown in FIG. 8; FIG. 12 is a left side view of the shoe shown in FIG. 8; FIG. 13 is a top view of the shoe shown in FIG. 8; FIG. 14 is a bottom view of the shoe shown in FIG. 8; FIG. 15 is a perspective view of another shoe with straps and studs; FIG. 16 is a front view of the shoe shown in FIG. 15; FIG. 17 is a rear view of the shoe shown in FIG. 15; FIG. 18 is a left side view of the shoe shown in FIG. 15; FIG. 19 is a right side view of the shoe shown in FIG. 15; FIG. 20 is a top view of the shoe shown in FIG. 15; and, FIG. 21 is a bottom view of the shoe shown in FIG. 15. The broken lines in FIGS. 15-21 are included for the purpose of illustrating environment and form no part of the claimed design.

**1 Claim, 17 Drawing Sheets**

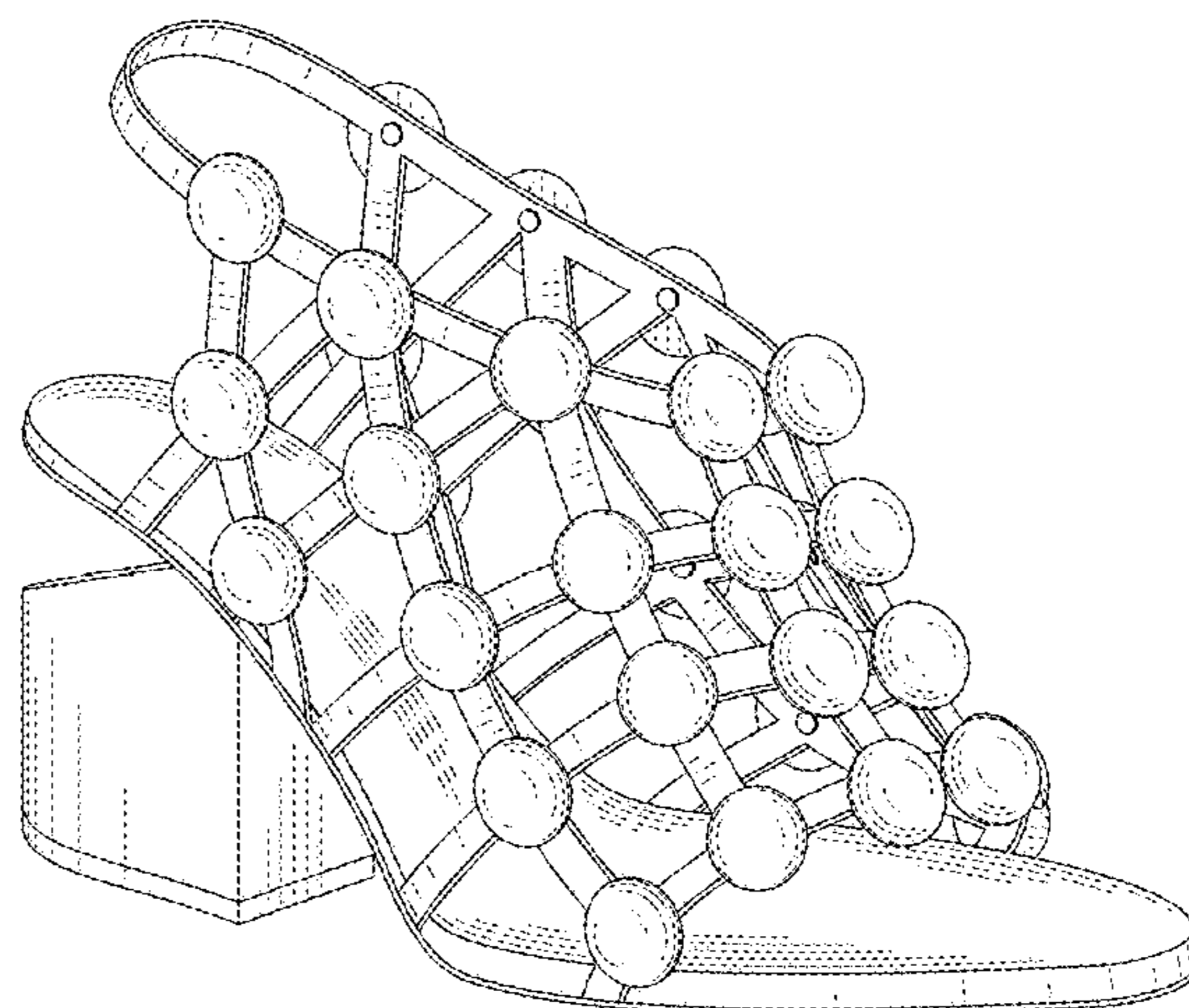
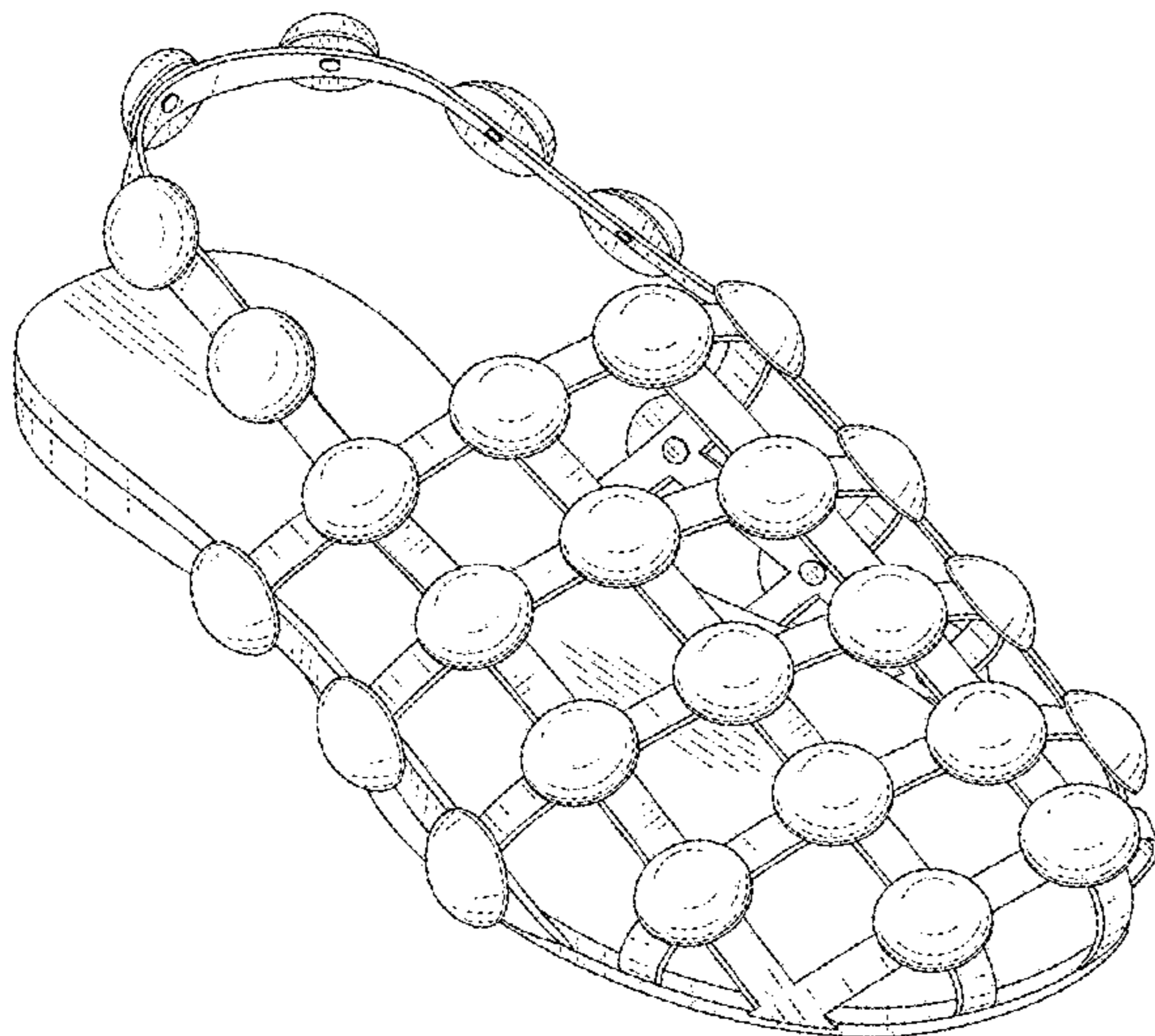

(56)

**References Cited**

U.S. PATENT DOCUMENTS

D774,737 S	*	12/2016	Sassi .....	D2/929
D775,797 S	*	1/2017	Sassi .....	D2/929
D798,033 S	*	9/2017	Osorio .....	D2/929
D798,549 S	*	10/2017	De Biase .....	D2/935
D801,647 S	*	11/2017	Mitchell .....	D2/916
D812,354 S	*	3/2018	Sassi .....	D2/939
D814,152 S	*	4/2018	De Nubbio .....	D2/930
D814,163 S	*	4/2018	Issler .....	D2/971
D814,166 S	*	4/2018	Beckett .....	D2/971
D815,401 S	*	4/2018	Sassi .....	D2/925

\* cited by examiner

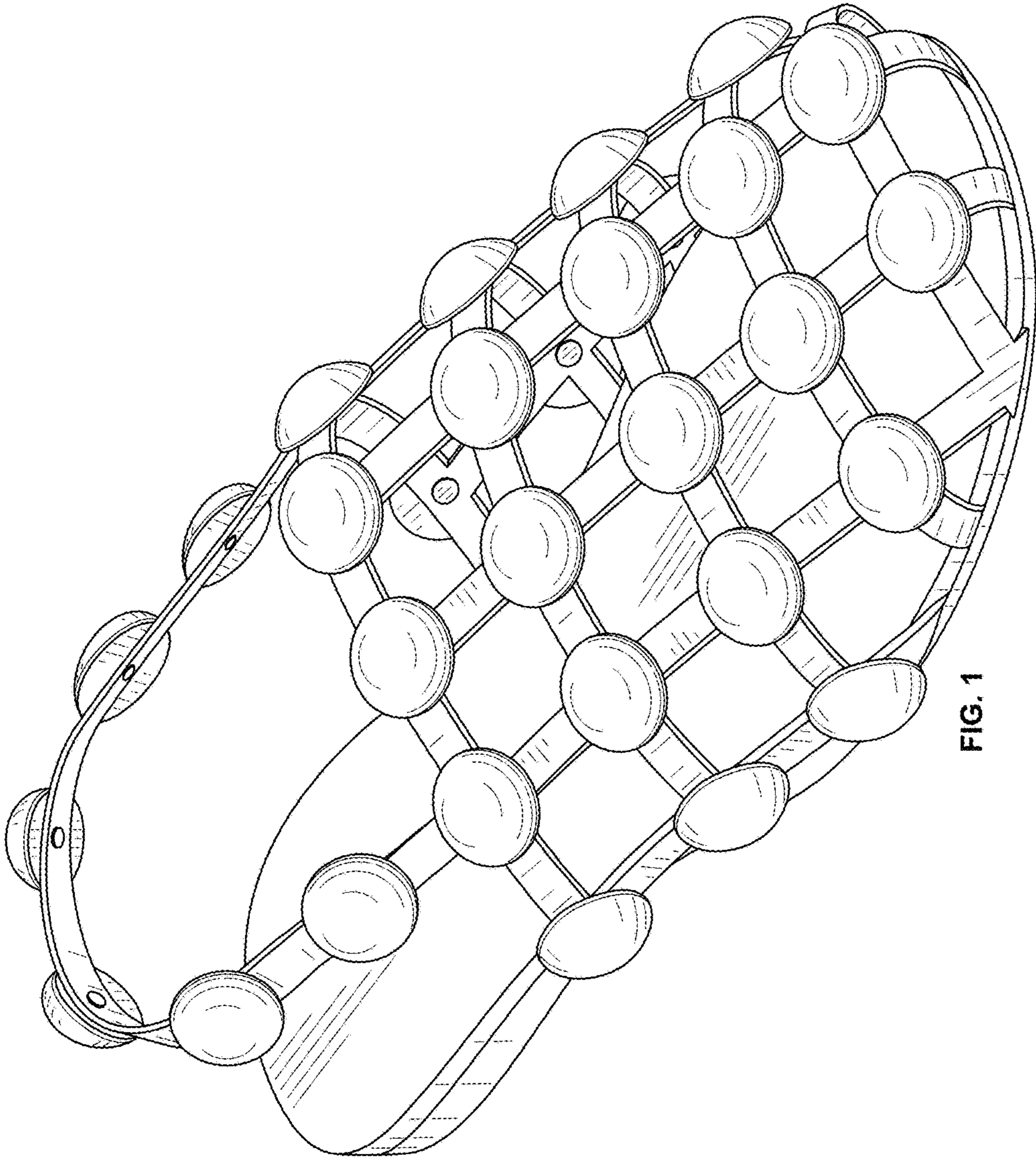

FIG. 1

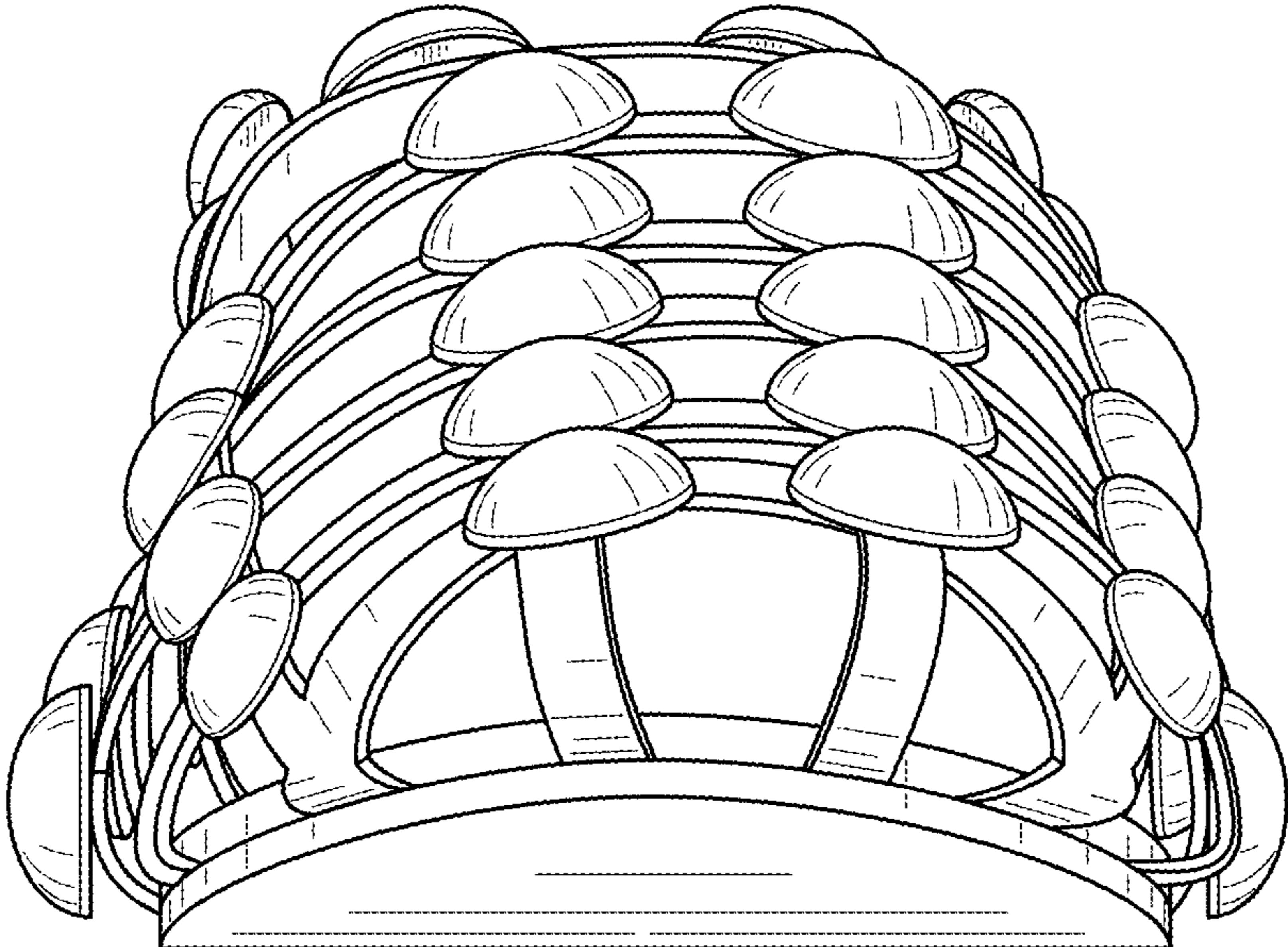

FIG. 2

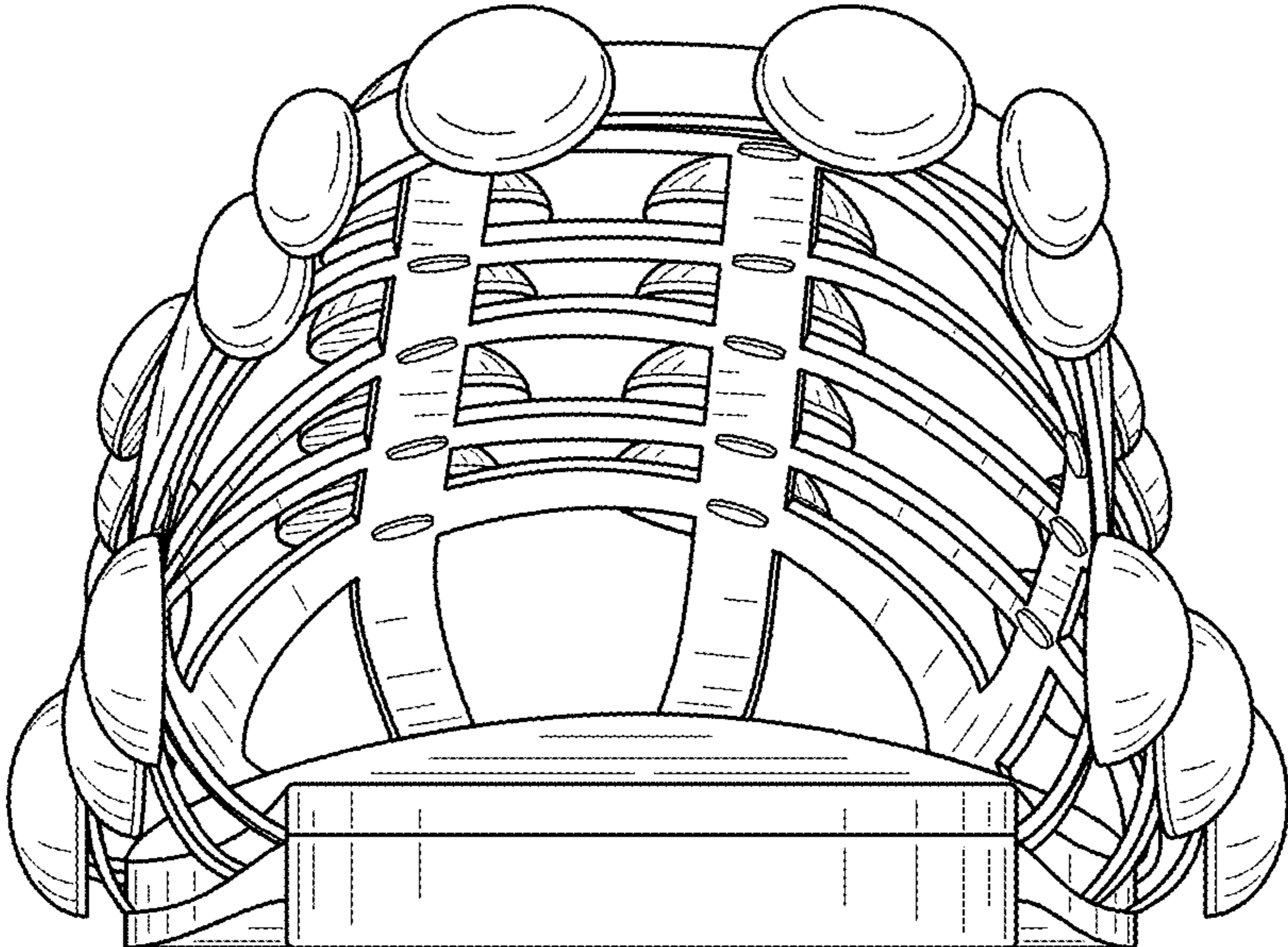

FIG. 3

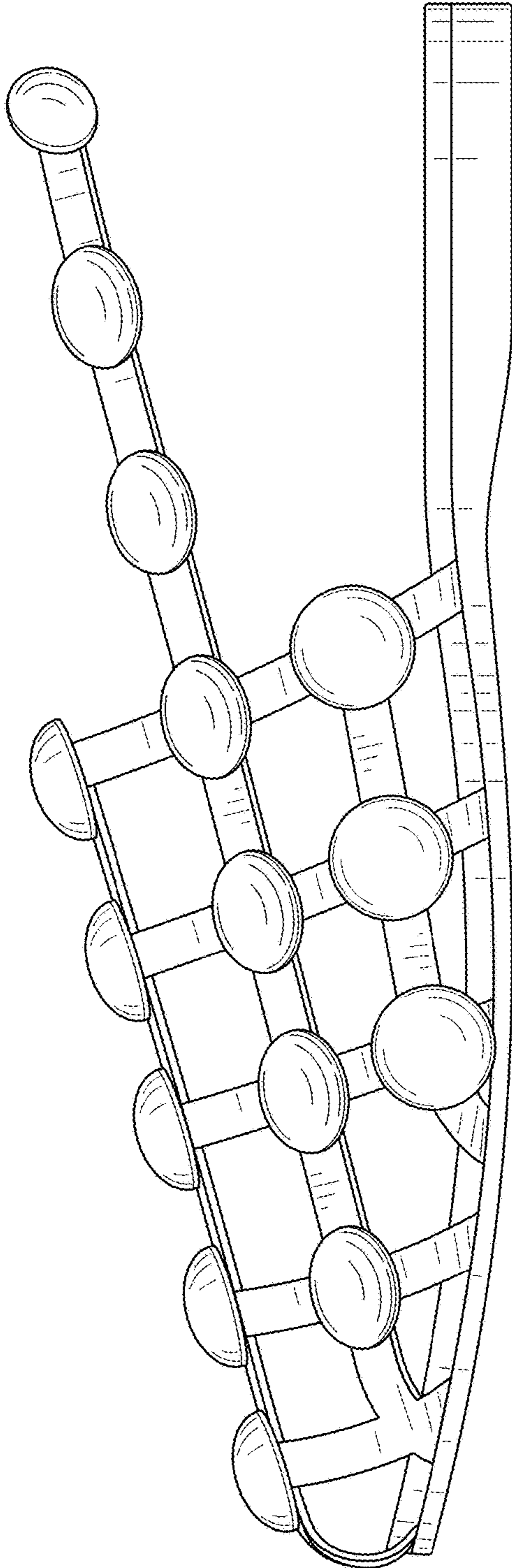

FIG. 4

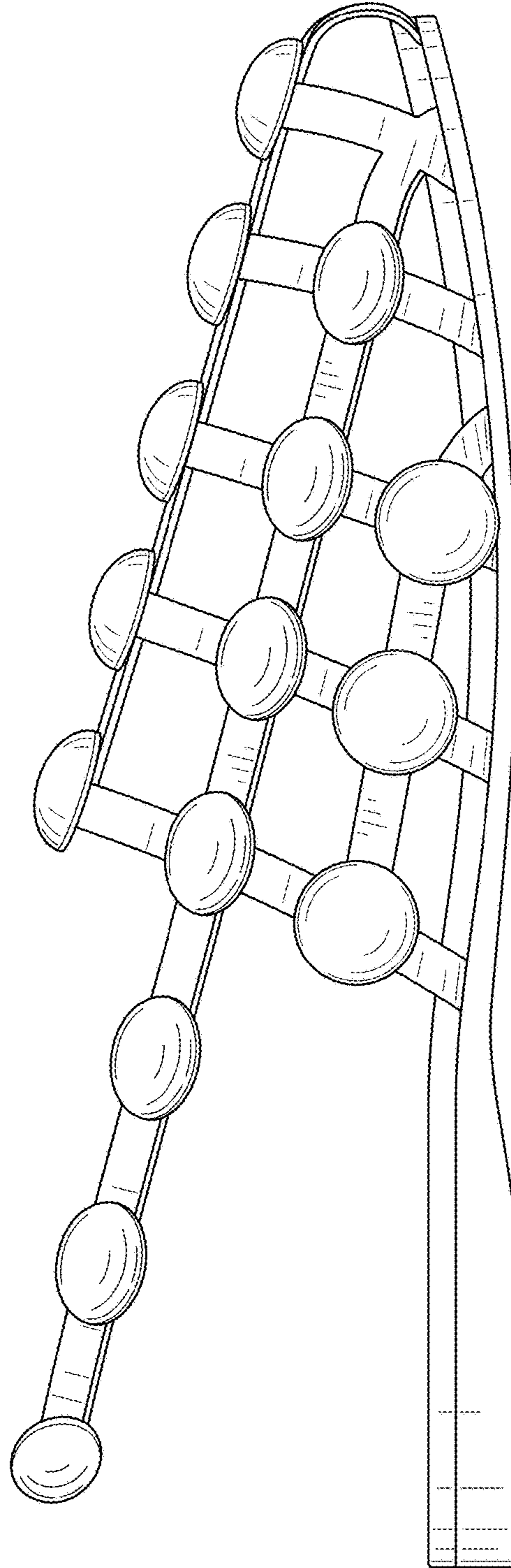

FIG. 5

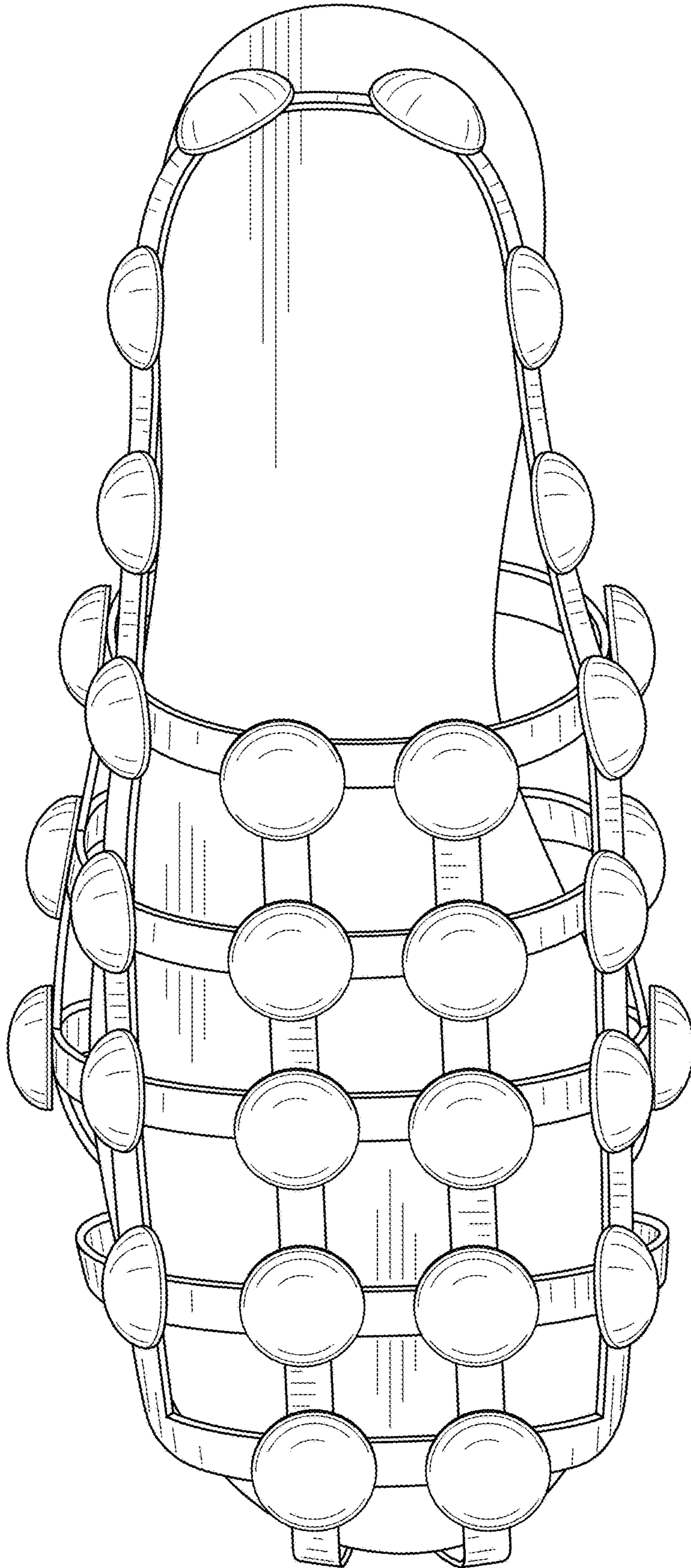

FIG. 6

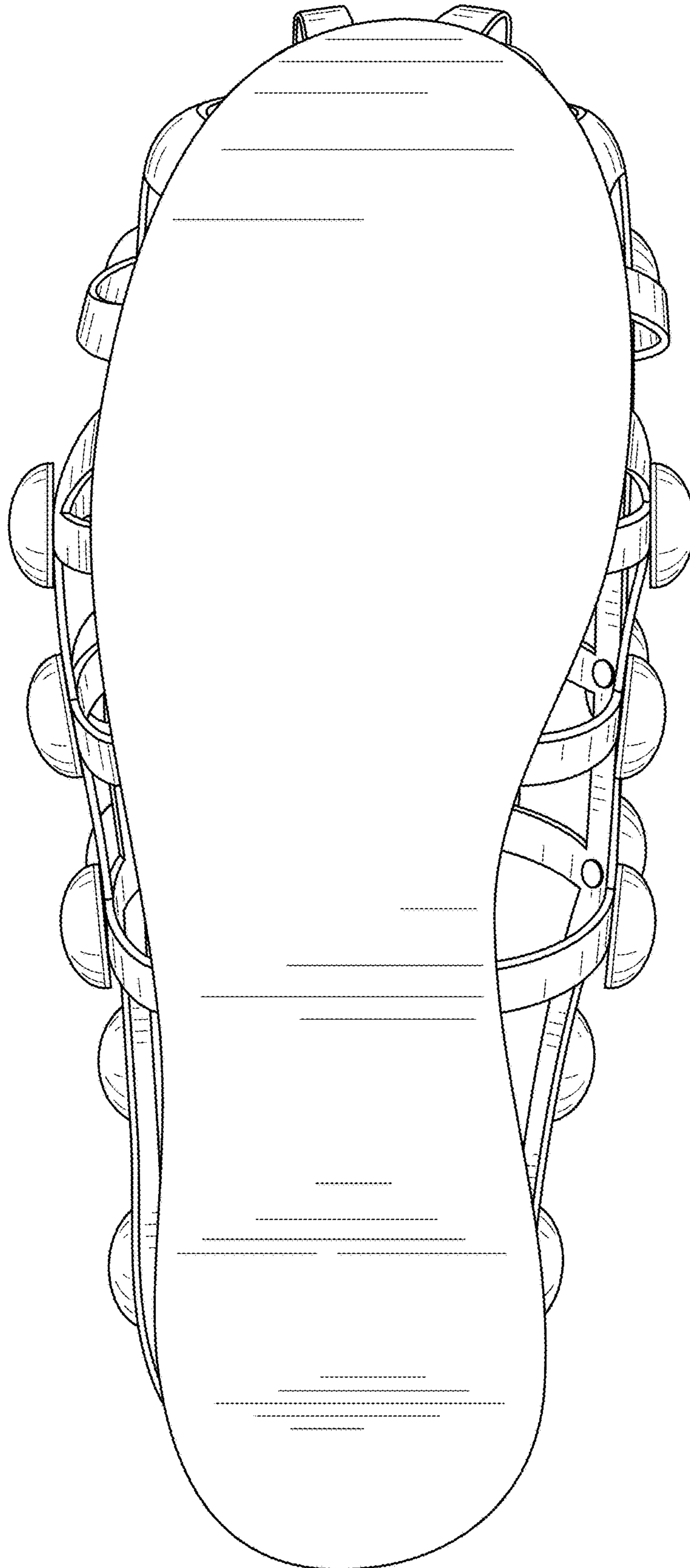

FIG. 7

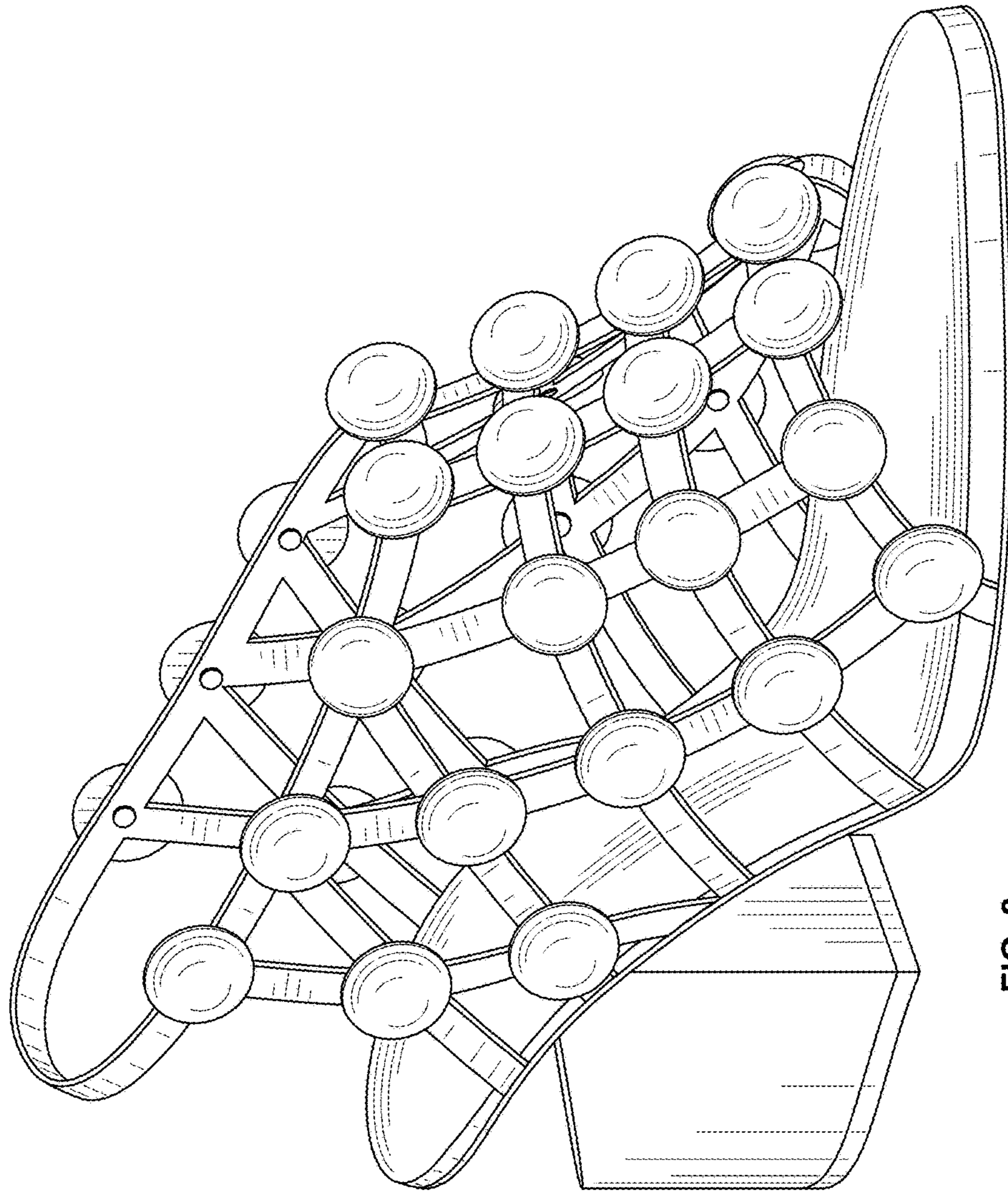

FIG. 8



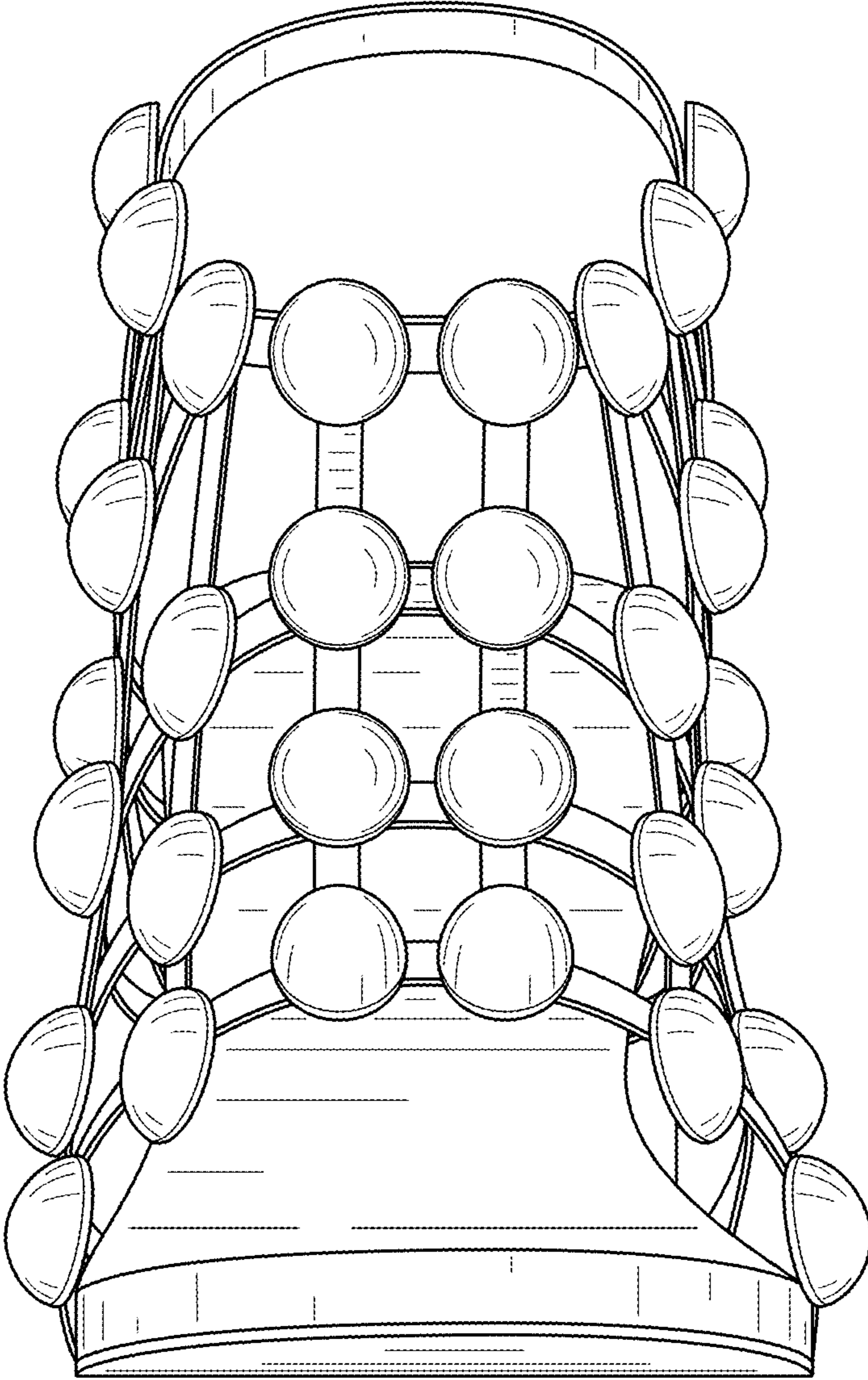

FIG. 9

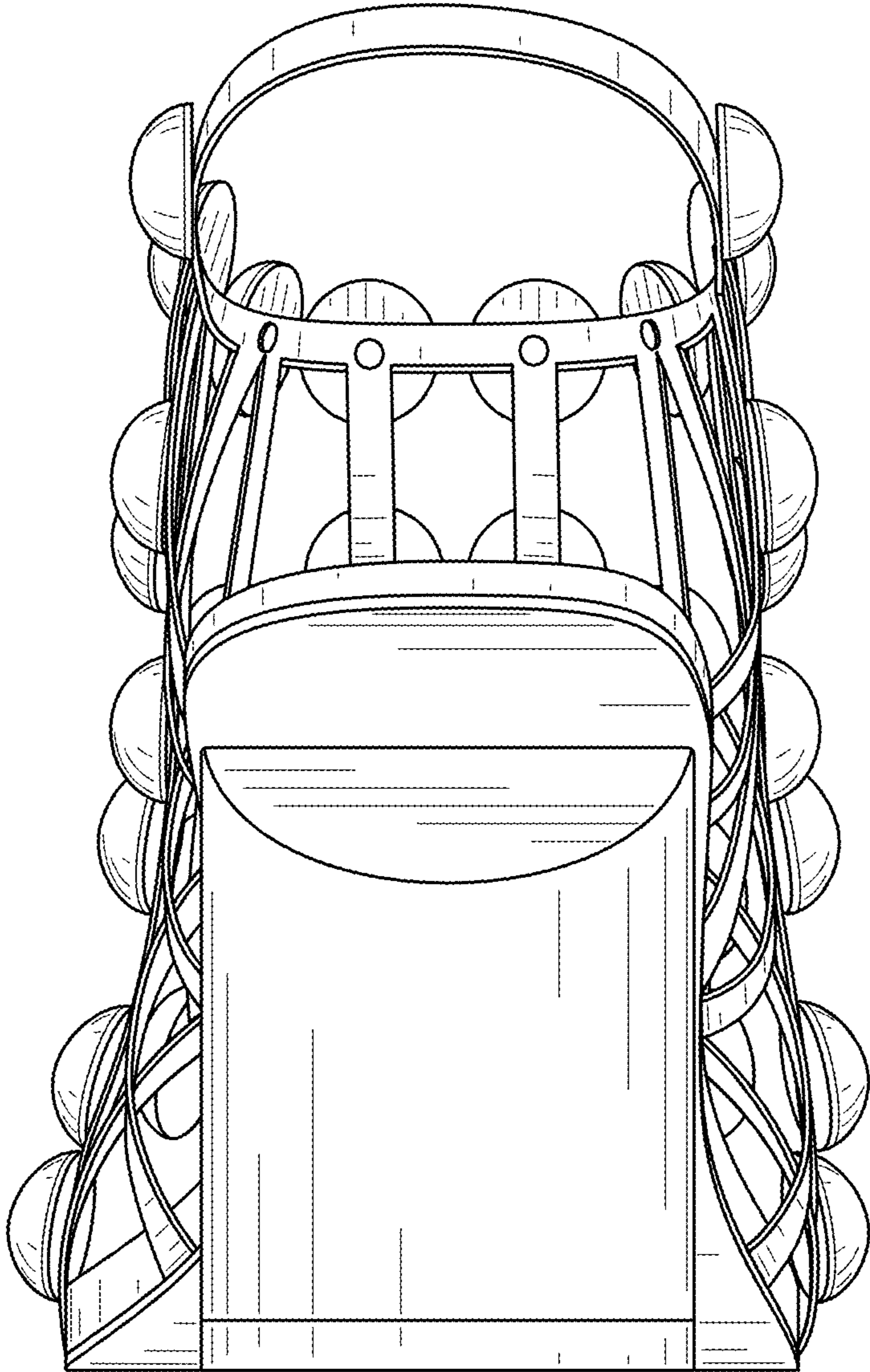

FIG. 10

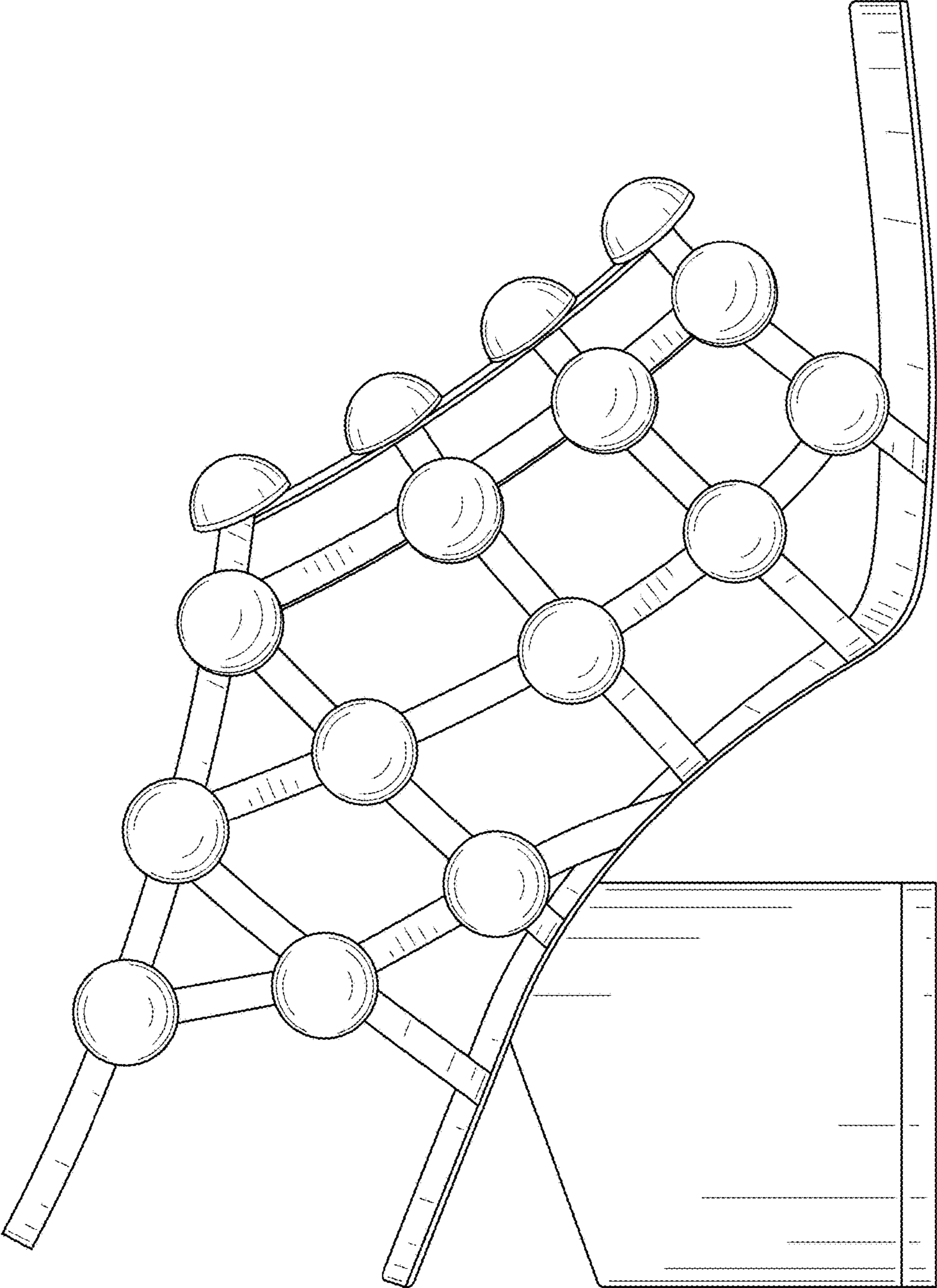

FIG. 11

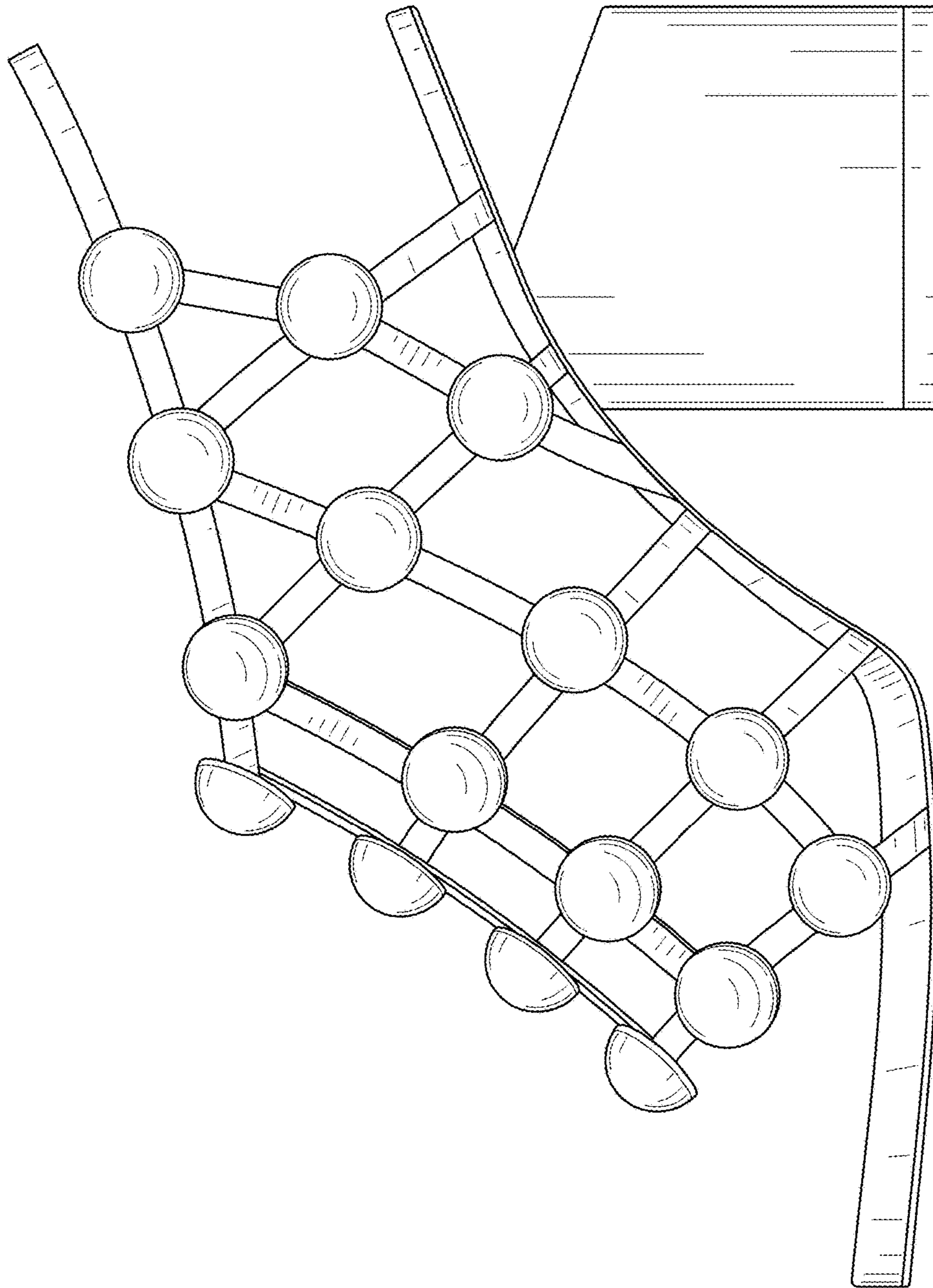

FIG. 12

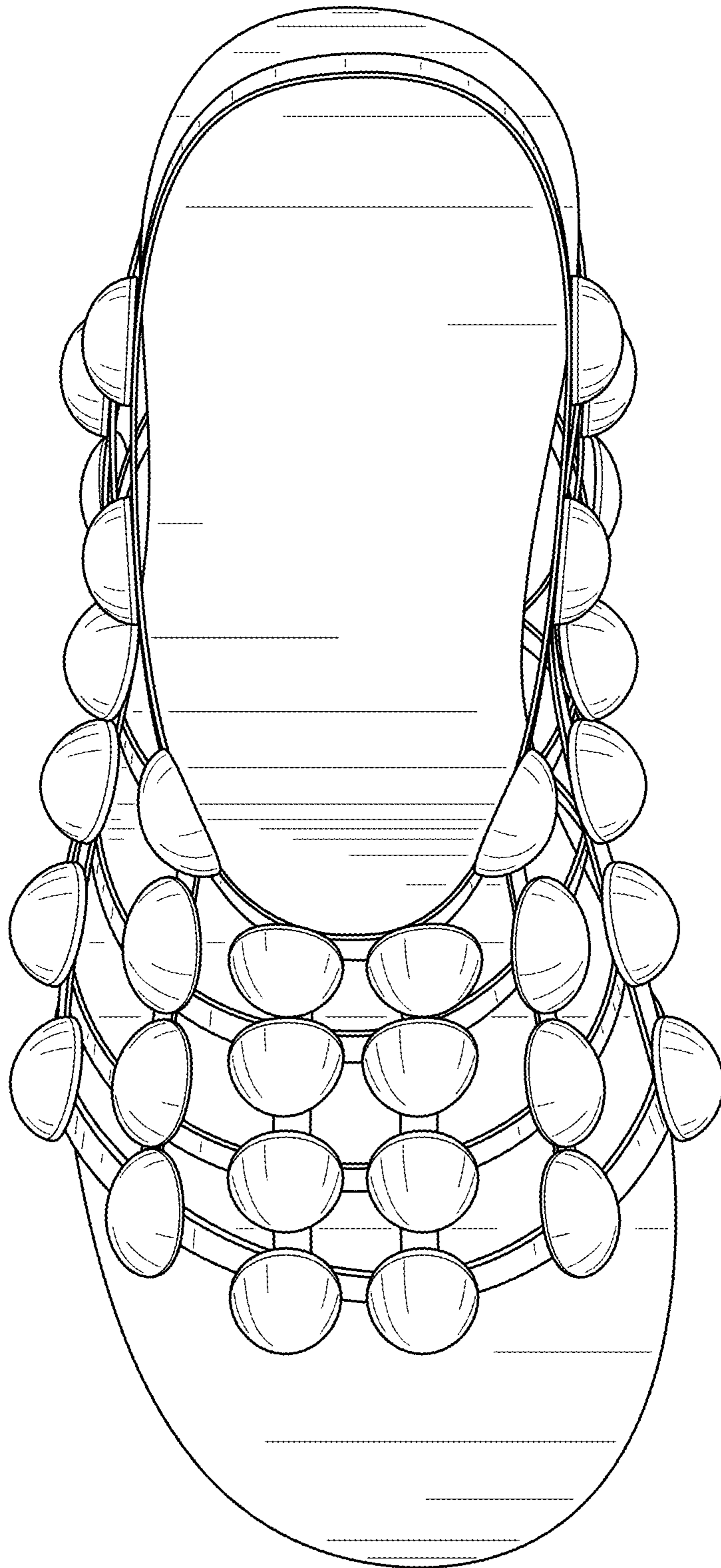

FIG. 13

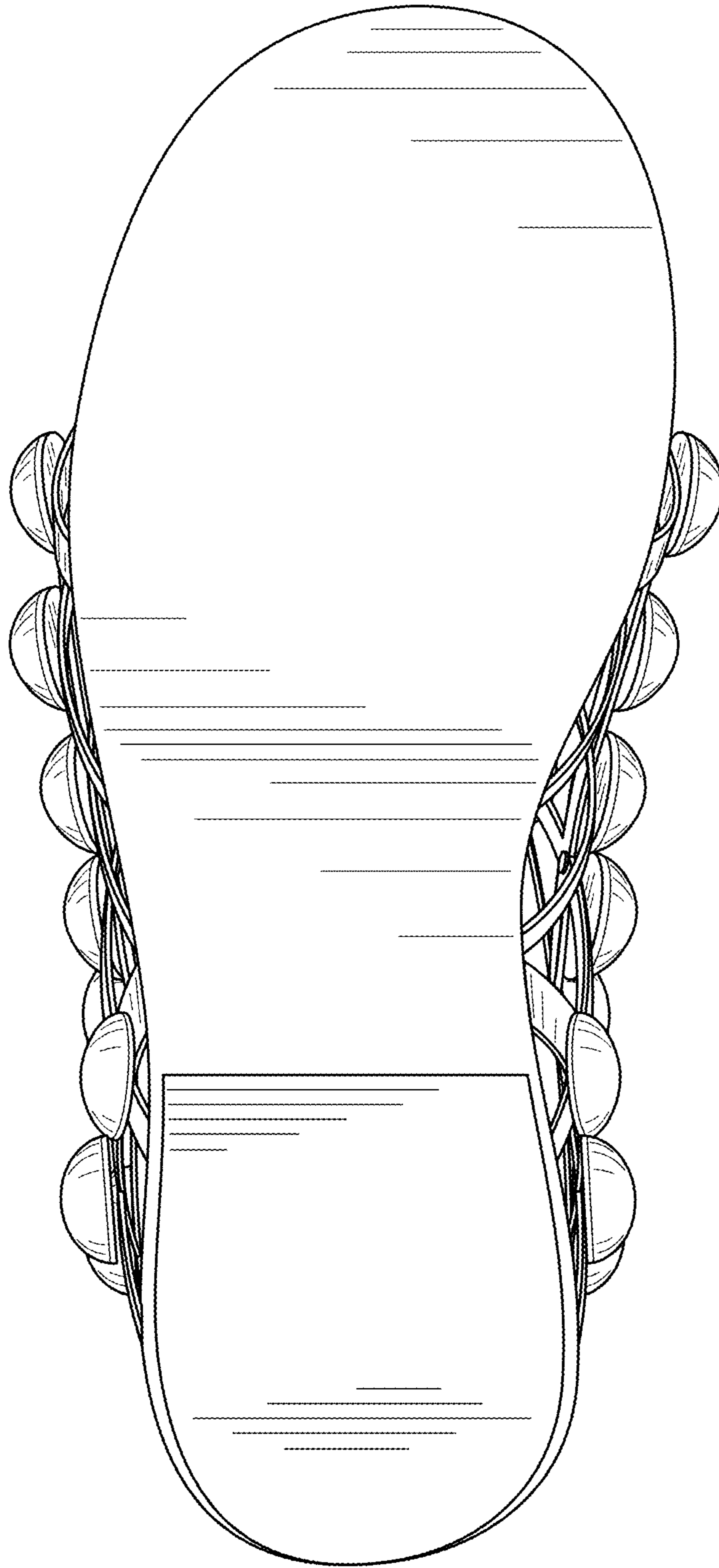

FIG. 14

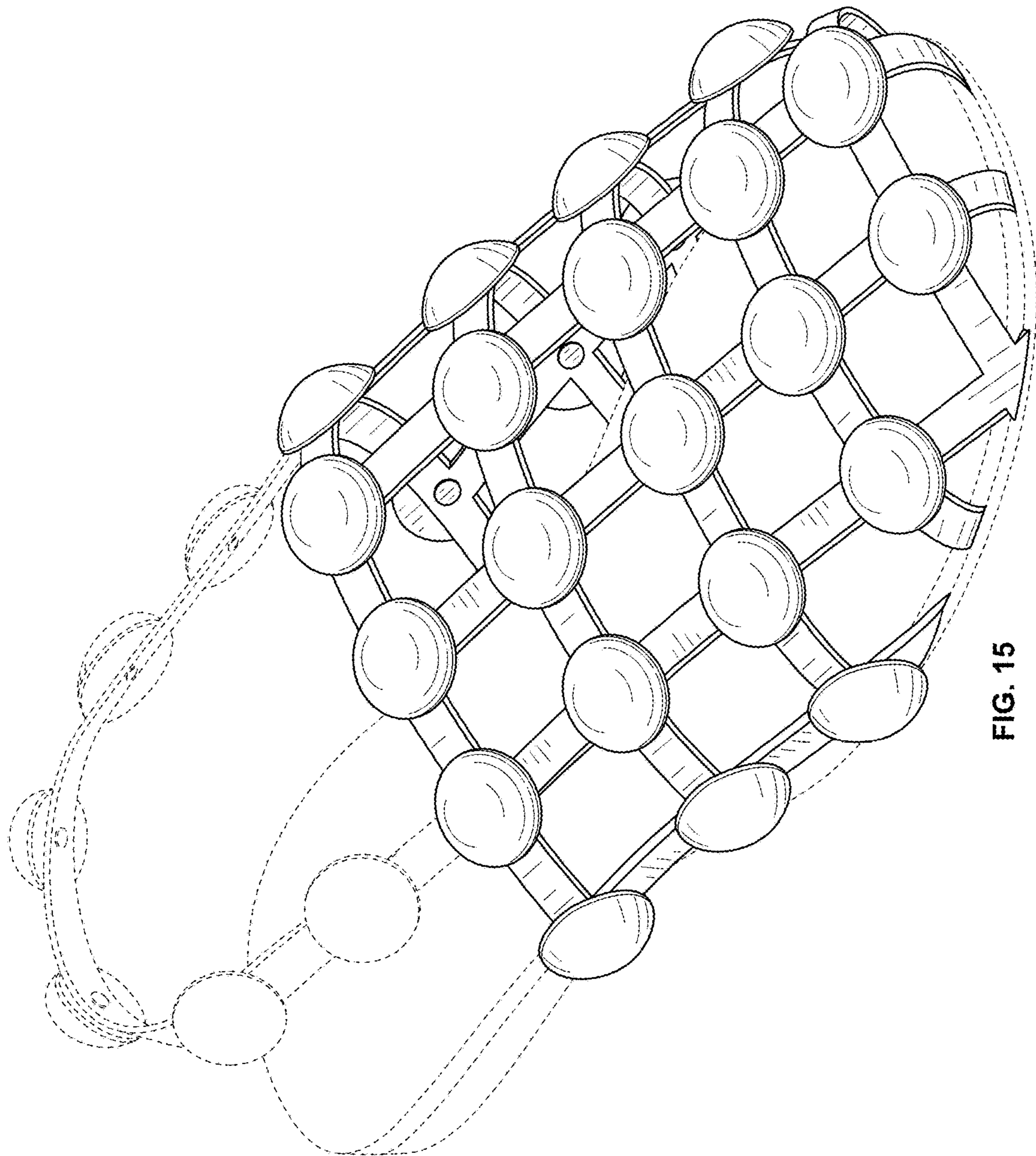

FIG. 15

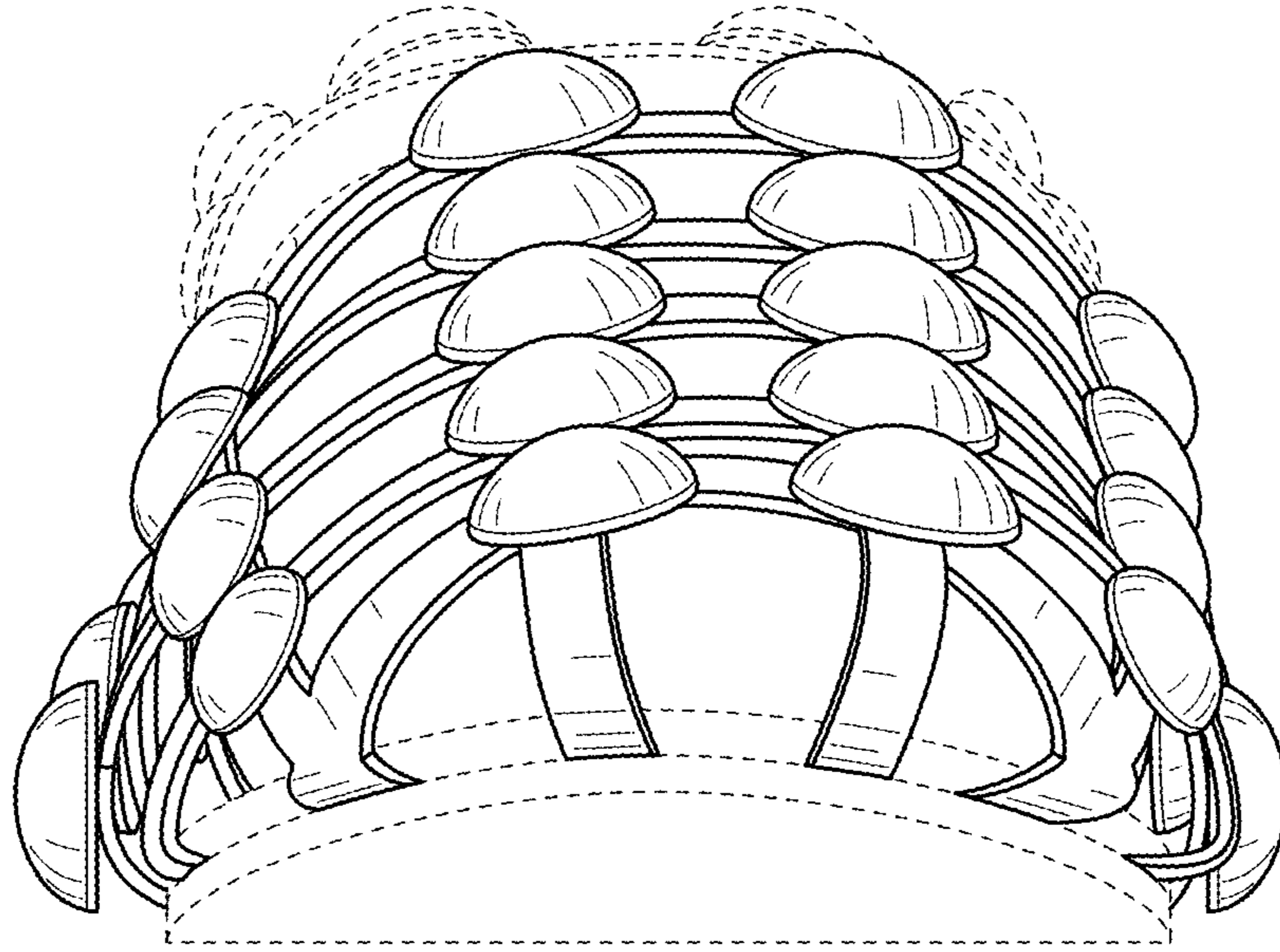

FIG. 16

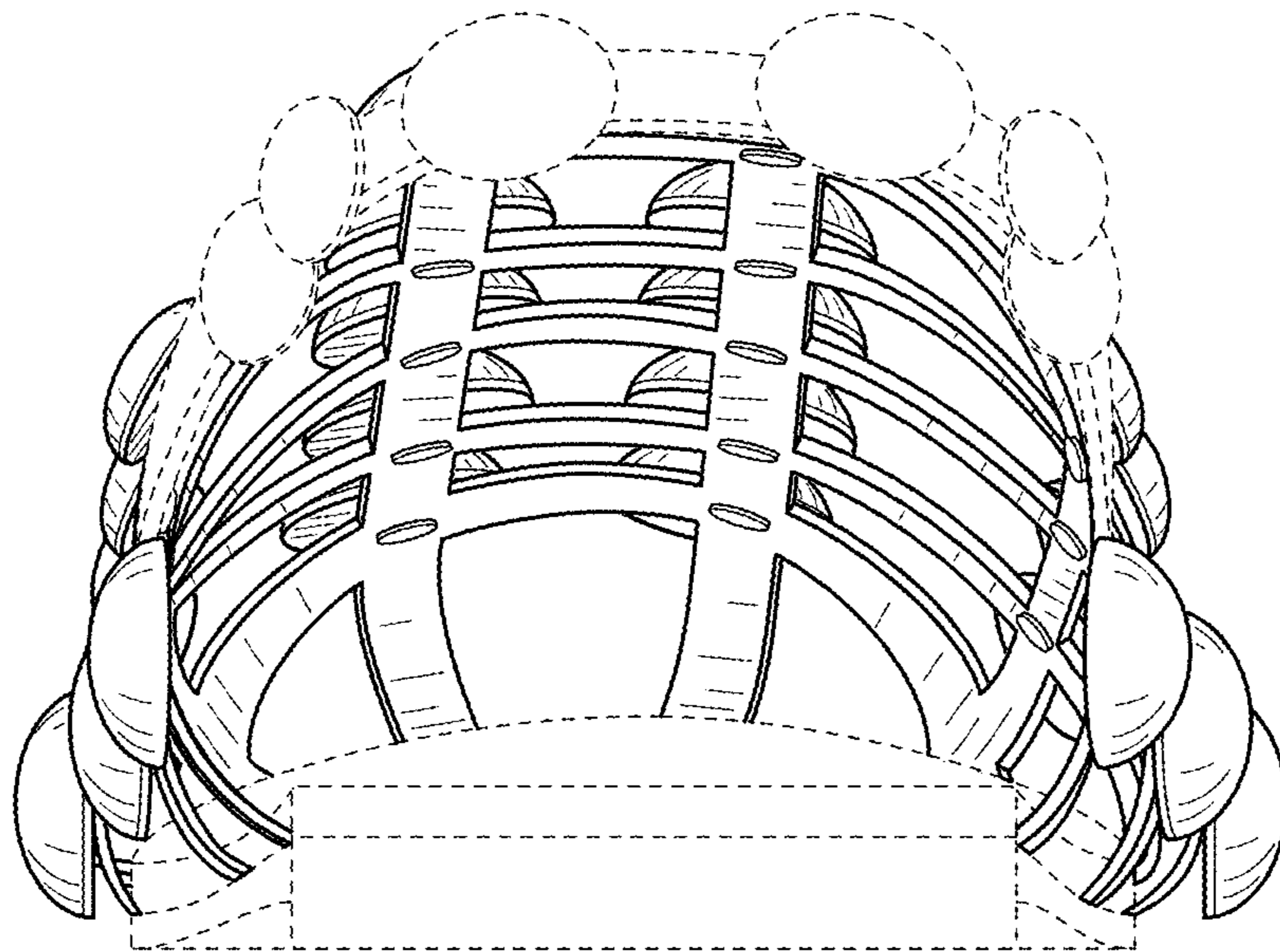

FIG. 17



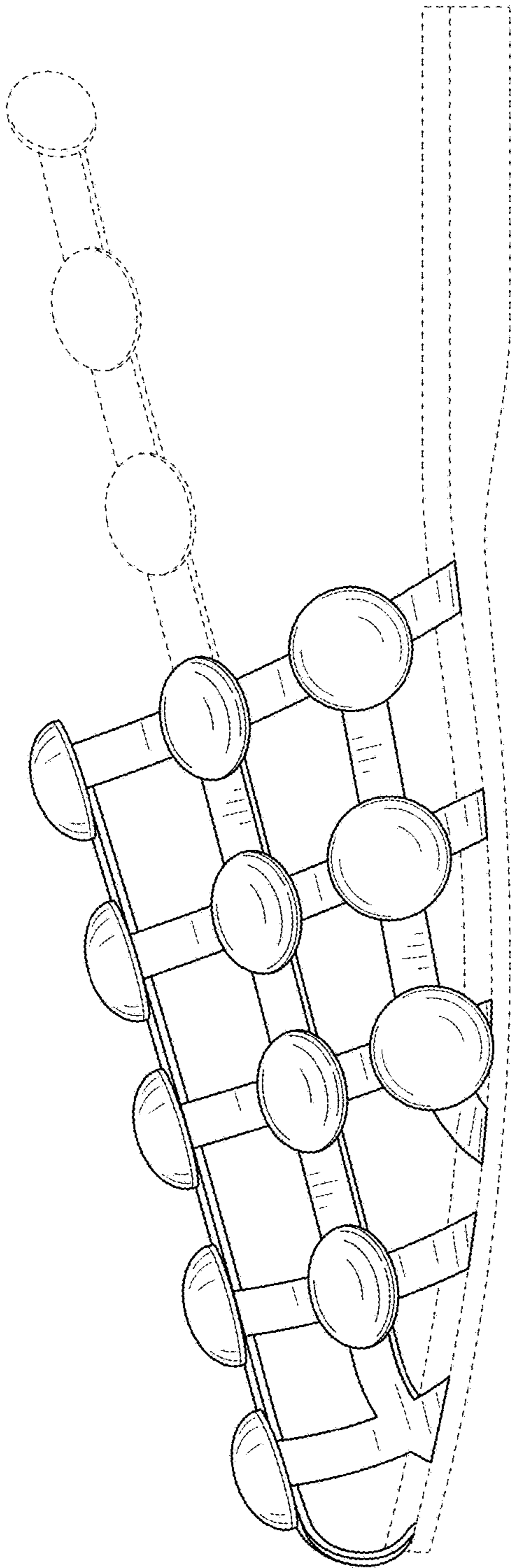

FIG. 18

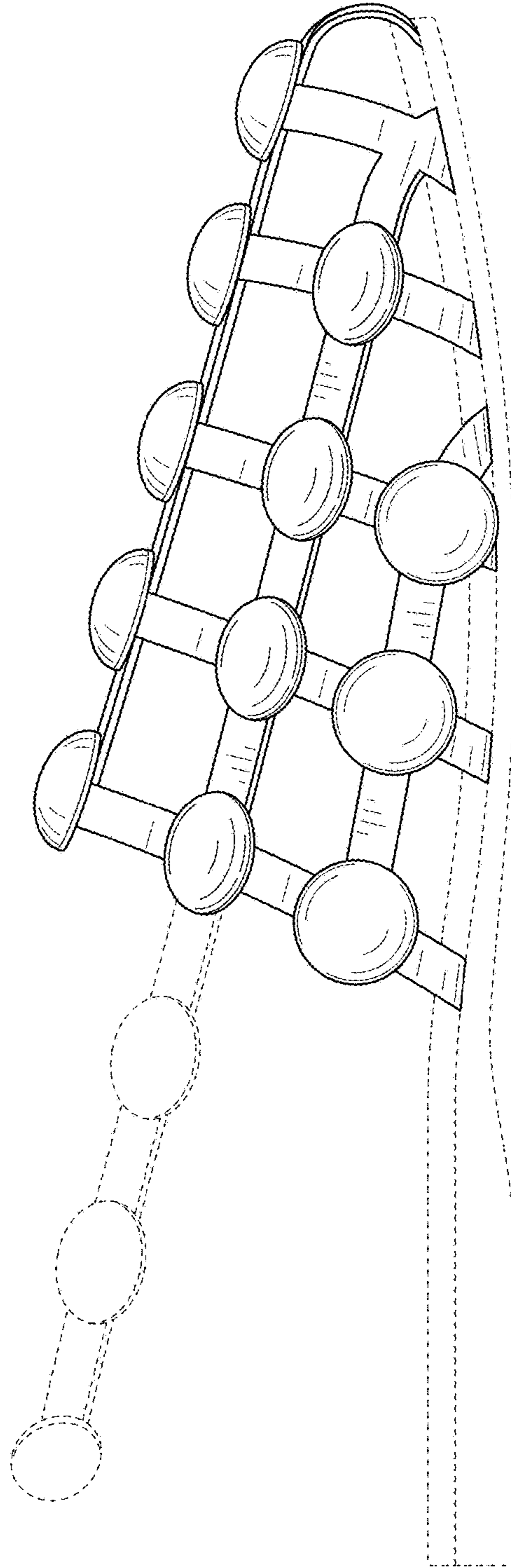

FIG. 19

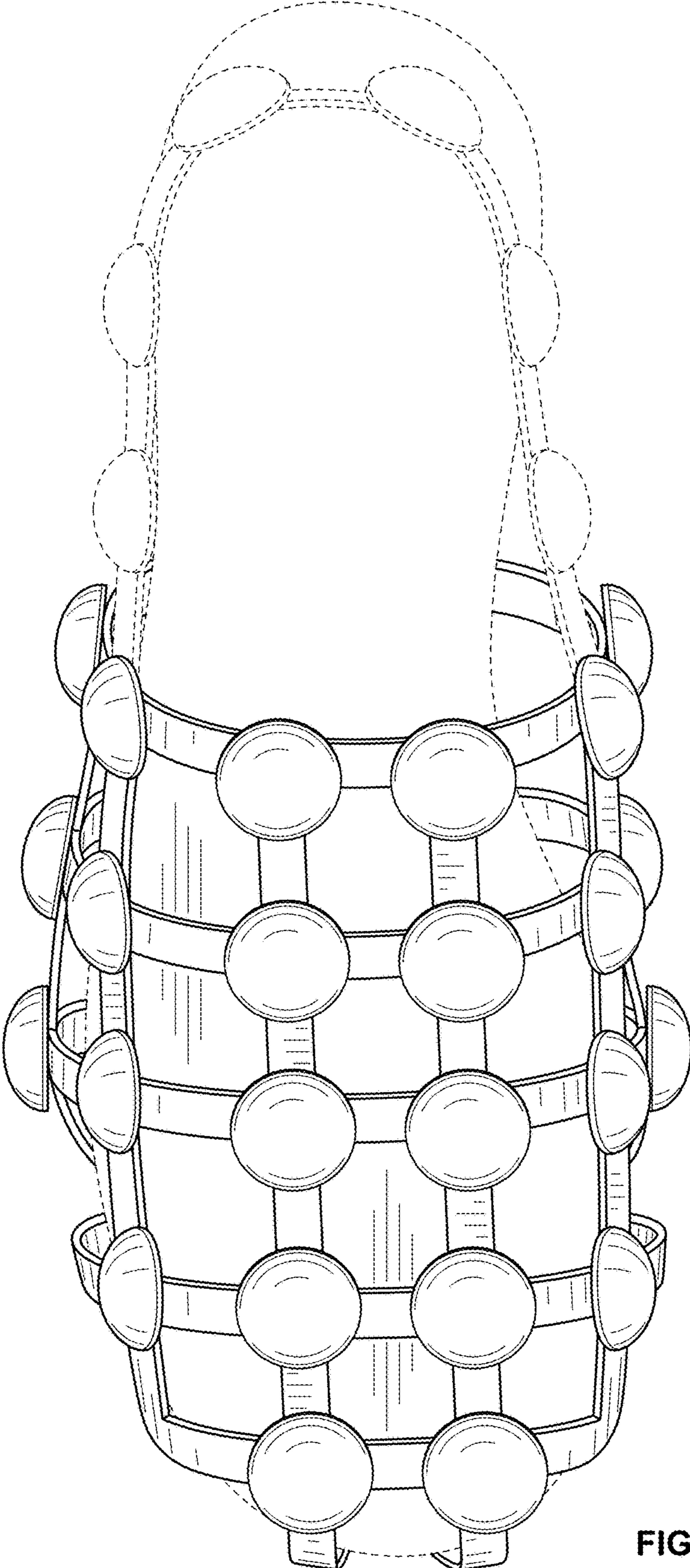

FIG. 20

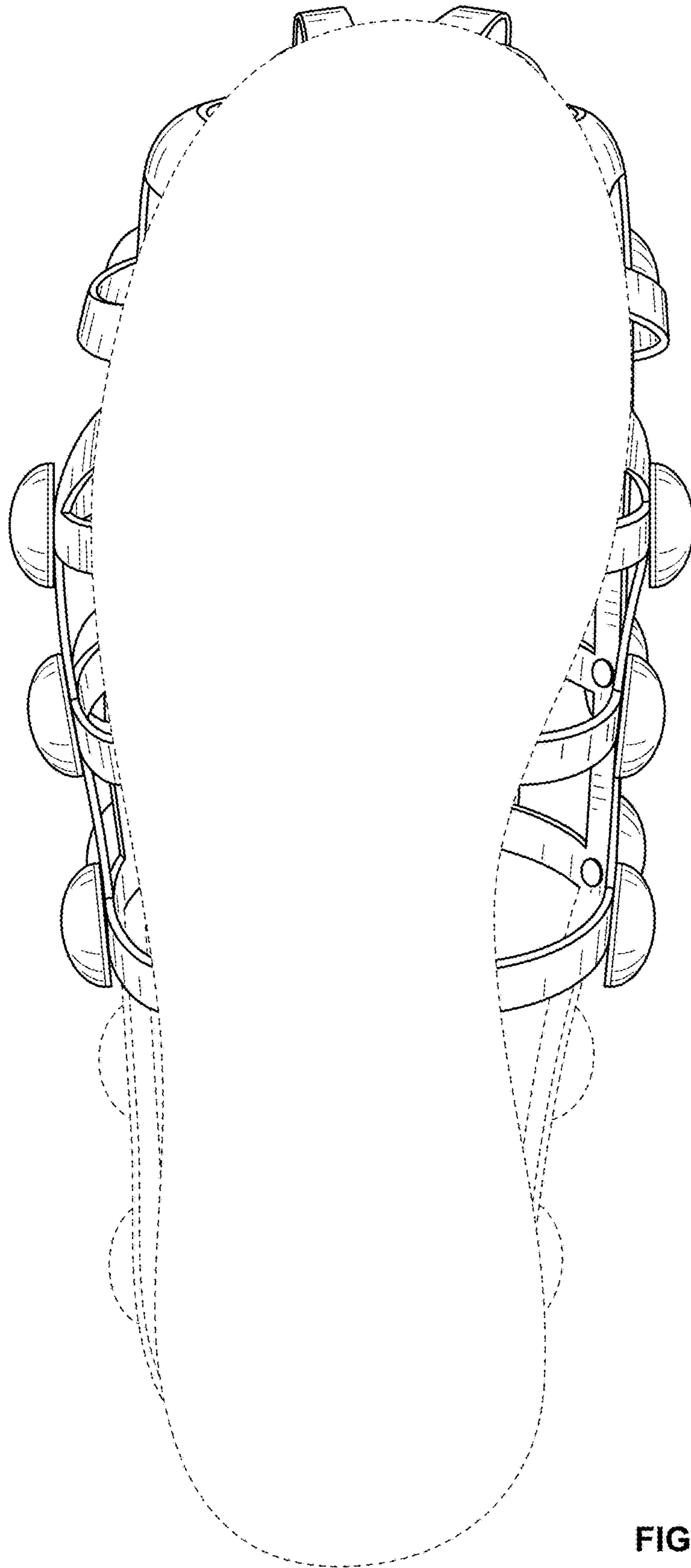

FIG. 21