



US00D827994S

(12) **United States Design Patent** (10) **Patent No.:** **US D827,994 S**  
**Sassi** (45) **Date of Patent:** **\*\* Sep. 11, 2018**

- (54) **SHOE**
- (71) Applicant: **VALENTINO S.p.A.**, Milan (IT)
- (72) Inventor: **Stefano Sassi**, Milan (IT)
- (73) Assignee: **VALENTINO S.p.A.**, Milan (IT)
- (\*\*) Term: **15 Years**
- (21) Appl. No.: **29/610,150**
- (22) Filed: **Jul. 10, 2017**
- (30) **Foreign Application Priority Data**

Jan. 11, 2017 (IT) ..... 402017000002399

- (51) **LOC (11) Cl.** ..... **02-04**
- (52) **U.S. Cl.**  
USPC ..... **D2/929**
- (58) **Field of Classification Search**  
USPC ..... D2/896, 900, 916-918, 925-942, 971  
CPC ..... A43B 21/00; A43B 21/02; A43B 21/06;  
A43B 9/14; A43B 1/0045; A43B 13/10;  
A43B 13/12; A43B 23/06; A43B 23/07;  
A43B 1/0036; A43B 5/12; A43B 3/248;  
A43B 9/02; A43B 13/122; A43B 13/14;  
A43B 3/108  
See application file for complete search history.

(56) **References Cited**  
U.S. PATENT DOCUMENTS

D71,136 S *	9/1926	Davis	.....	D2/929
D72,731 S *	5/1927	Siegel	.....	D2/929
D75,276 S *	5/1928	Miller	.....	D2/929
D91,532 S *	2/1934	Morali	.....	D2/939
D91,534 S *	2/1934	Morali	.....	D2/930
D93,040 S *	8/1934	Pape	.....	D2/938
D93,485 S *	10/1934	Levin	.....	D2/931
D93,515 S *	10/1934	Phifer	.....	D2/941

D93,808 S *	11/1934	Batterman	.....	D2/935
D94,513 S *	2/1935	Perugia	.....	D2/930
D94,962 S *	3/1935	Goldman	.....	D2/938
D95,527 S *	5/1935	Levin	.....	D2/939
D95,991 S *	6/1935	Siegel	.....	D2/938
D96,661 S *	8/1935	Goldman	.....	D2/938
D97,518 S *	11/1935	Abowitz	.....	D2/931
D98,907 S *	3/1936	Audino	.....	D2/931
D500,403 S *	1/2005	Belley	.....	D2/969
D502,798 S *	3/2005	Belley	.....	D2/969
D513,836 S *	1/2006	Magro	.....	D2/896
D660,565 S *	5/2012	Della Valle	.....	D2/925
D662,309 S *	6/2012	Ard	.....	D2/971
D735,981 S *	8/2015	Louboutin	.....	D2/939
D765,954 S *	9/2016	Sassi	.....	D2/929
D766,557 S *	9/2016	Sassi	.....	D2/929
D774,737 S *	12/2016	Sassi	.....	D2/929
D775,797 S *	1/2017	Sassi	.....	D2/929

(Continued)

*Primary Examiner* — Dominic V Simone  
(74) *Attorney, Agent, or Firm* — Thomas I Horstemeyer, LLP

(57) **CLAIM**  
The ornamental design for a shoe, as shown and described.

**DESCRIPTION**

FIG. 1 is a perspective view of a shoe showing my new design;  
FIG. 2 is a front elevational view thereof;  
FIG. 3 is a rear elevational view thereof, opposite that of FIG. 2;  
FIG. 4 is a side elevational view thereof;  
FIG. 5 is a side elevational view thereof, from a side opposite that of FIG. 4;  
FIG. 6 is a top view thereof; and,  
FIG. 7 is a bottom view thereof, opposite that of FIG. 6.  
The broken lines in FIGS. 1-7 denote stitching on portions of the shoe and form part of the claimed design.

**1 Claim, 7 Drawing Sheets**

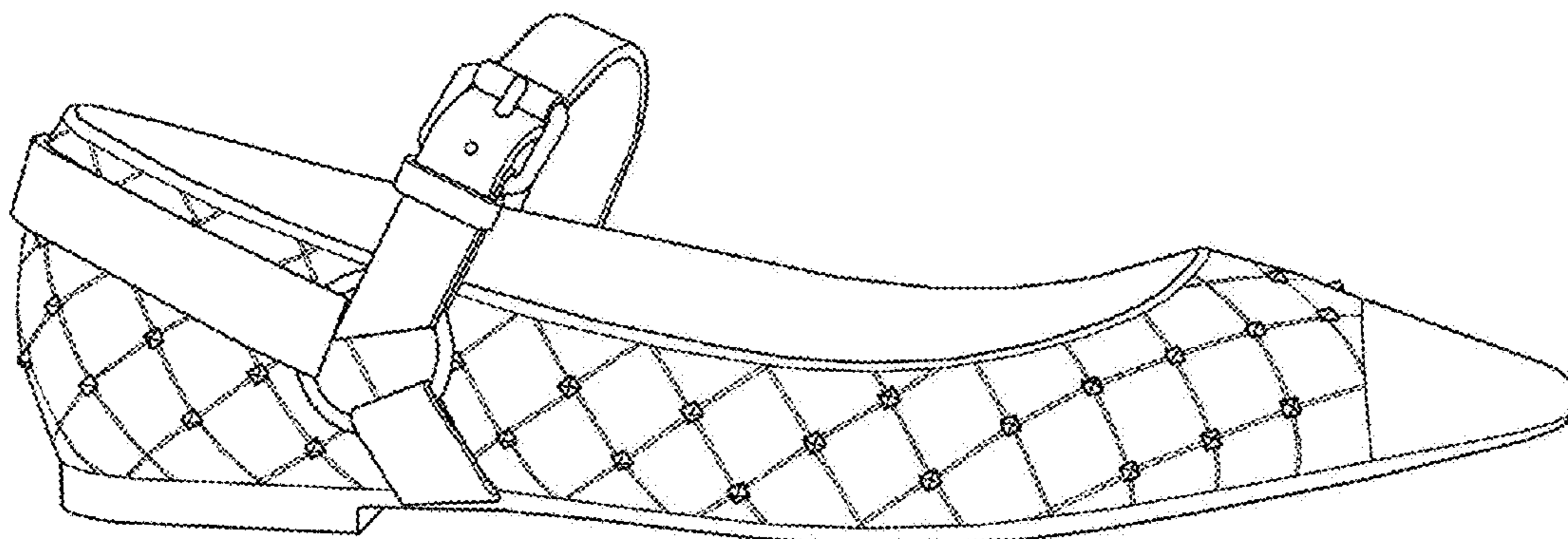

(56)

**References Cited**

U.S. PATENT DOCUMENTS

D812,354 S \* 3/2018 Sassi ..... D2/939  
D815,401 S \* 4/2018 Sassi ..... D2/925

\* cited by examiner

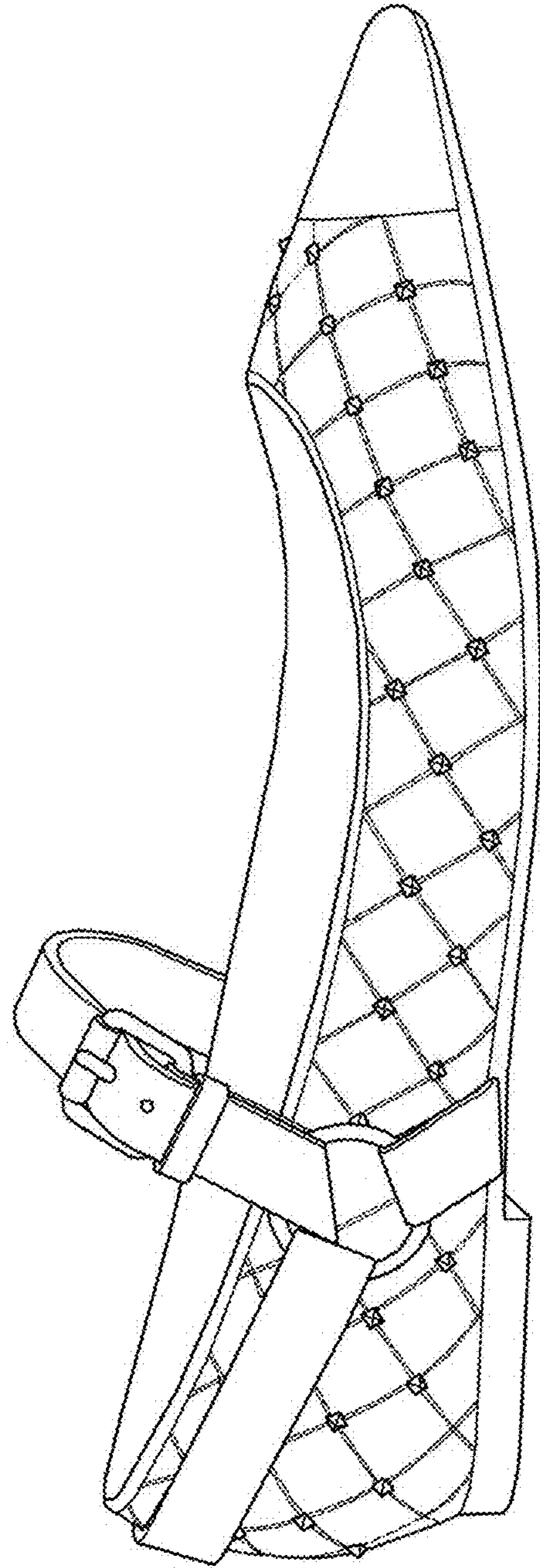

FIG. 1

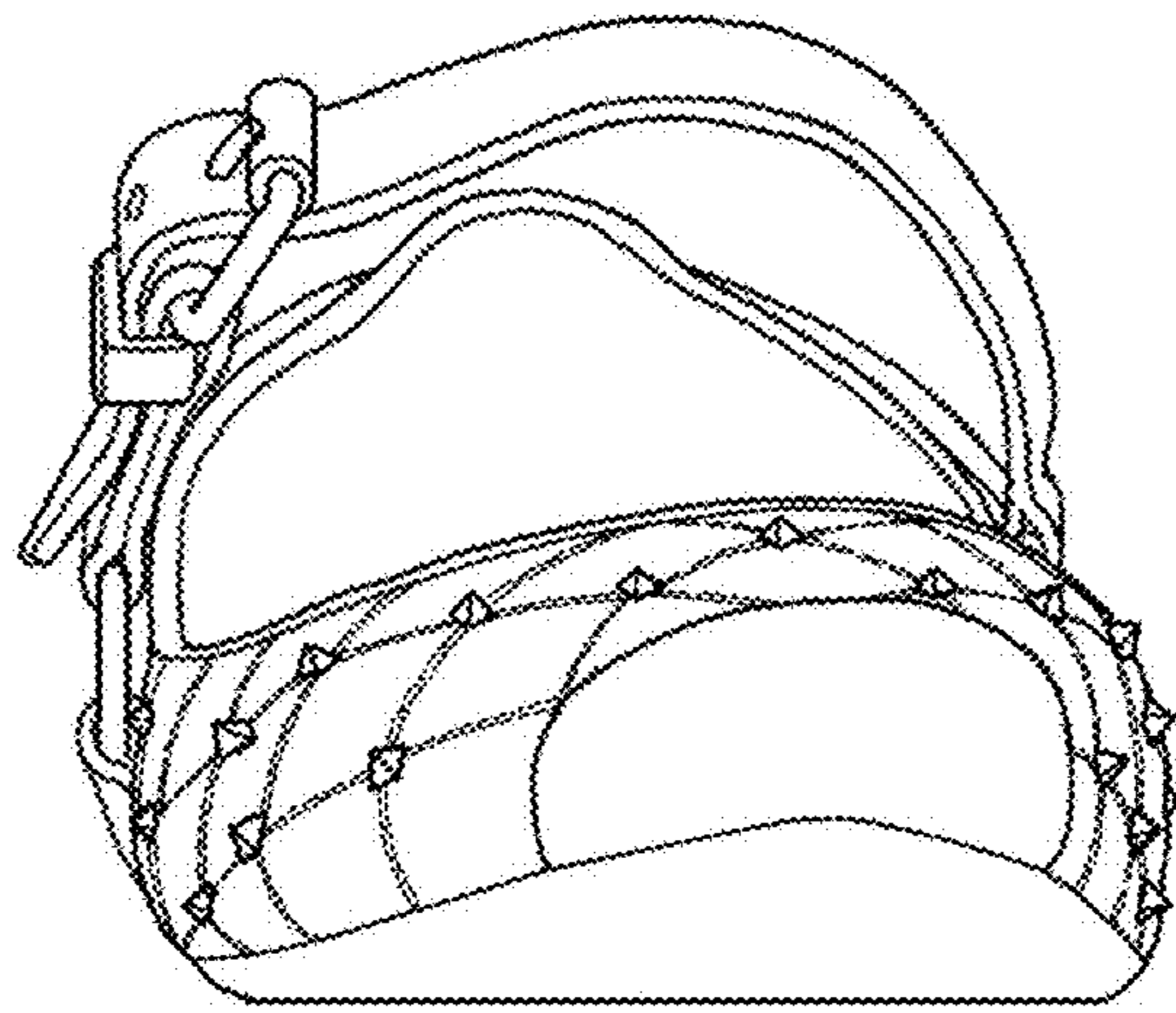

FIG. 2

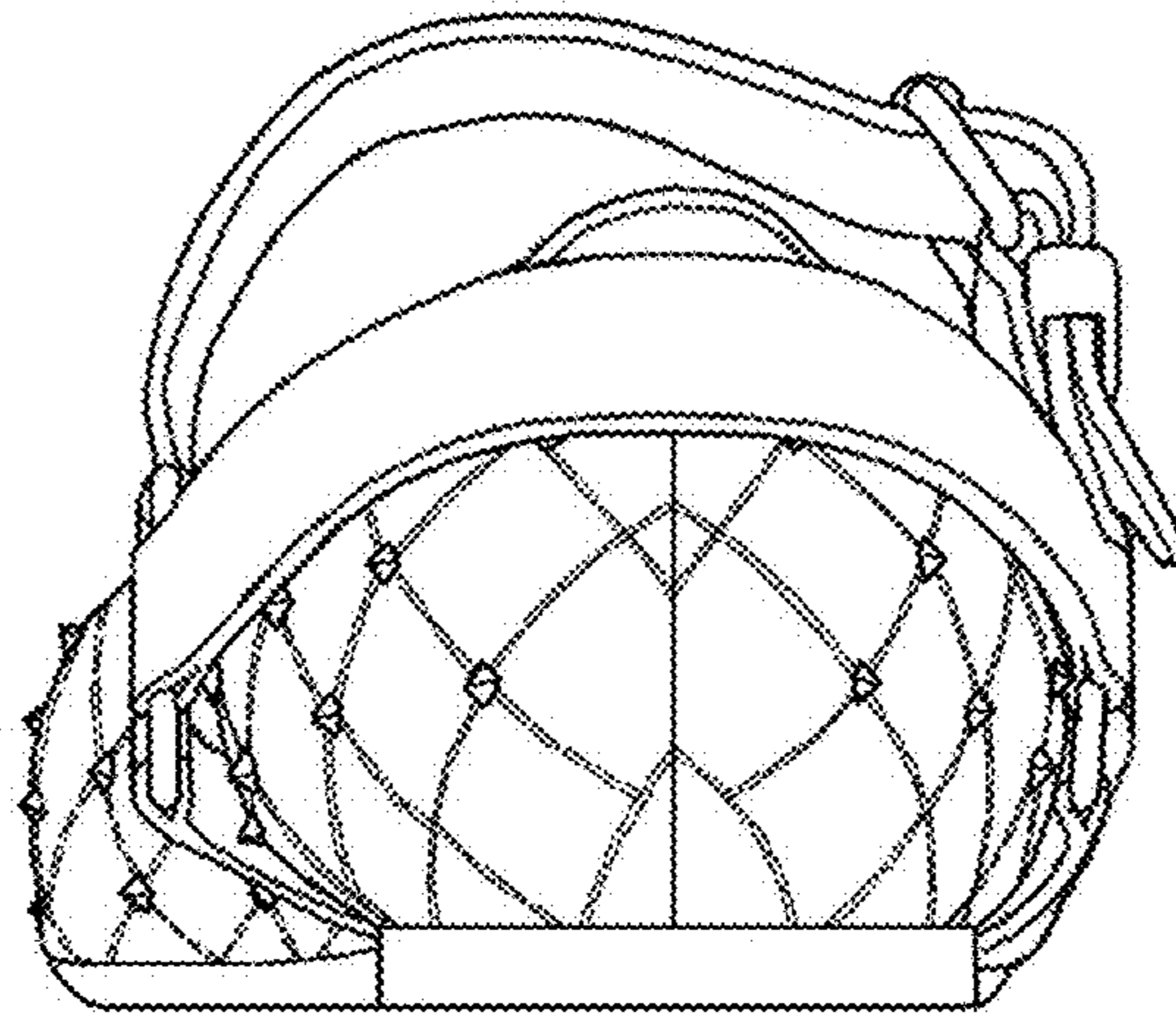

FIG. 3



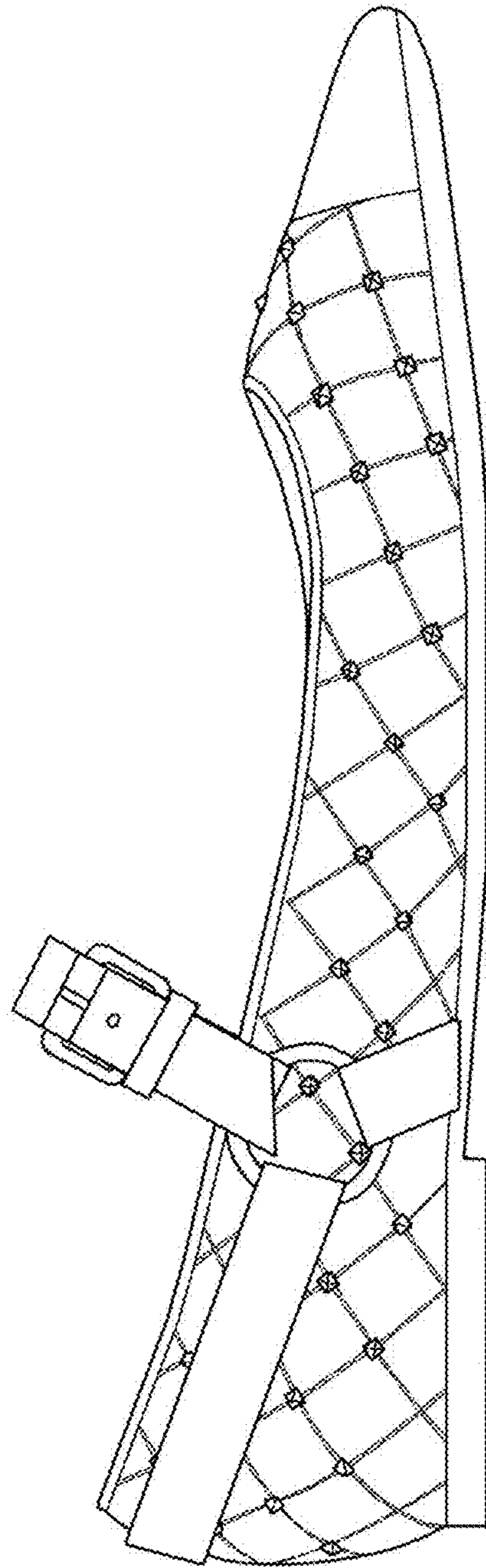

FIG. 4

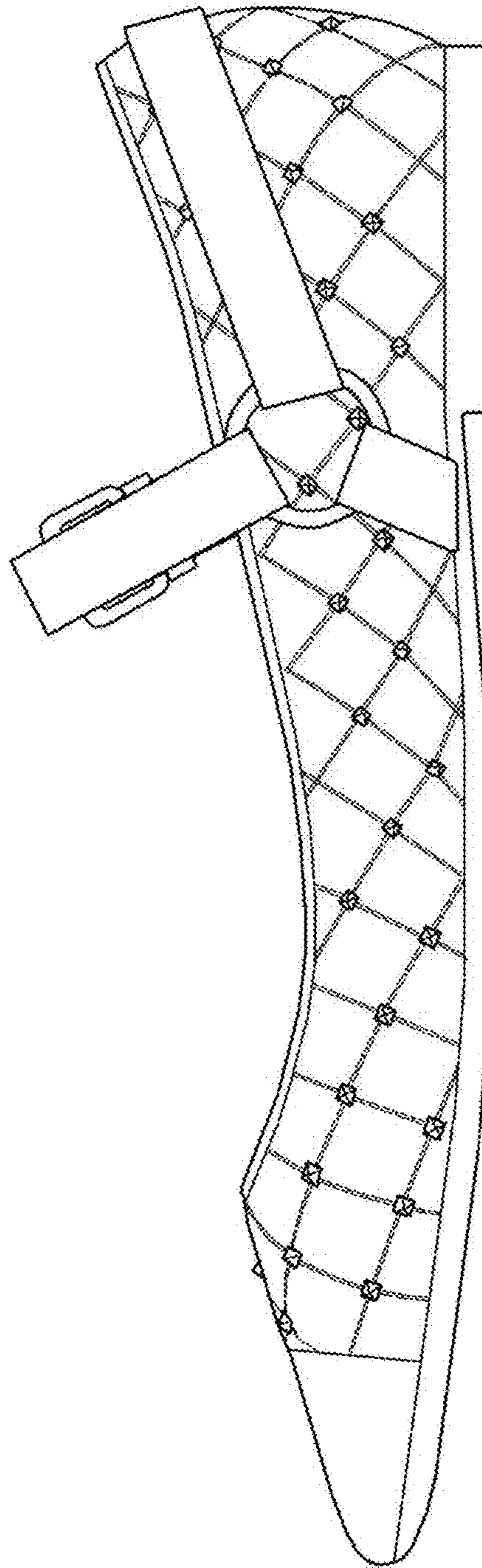

FIG. 5

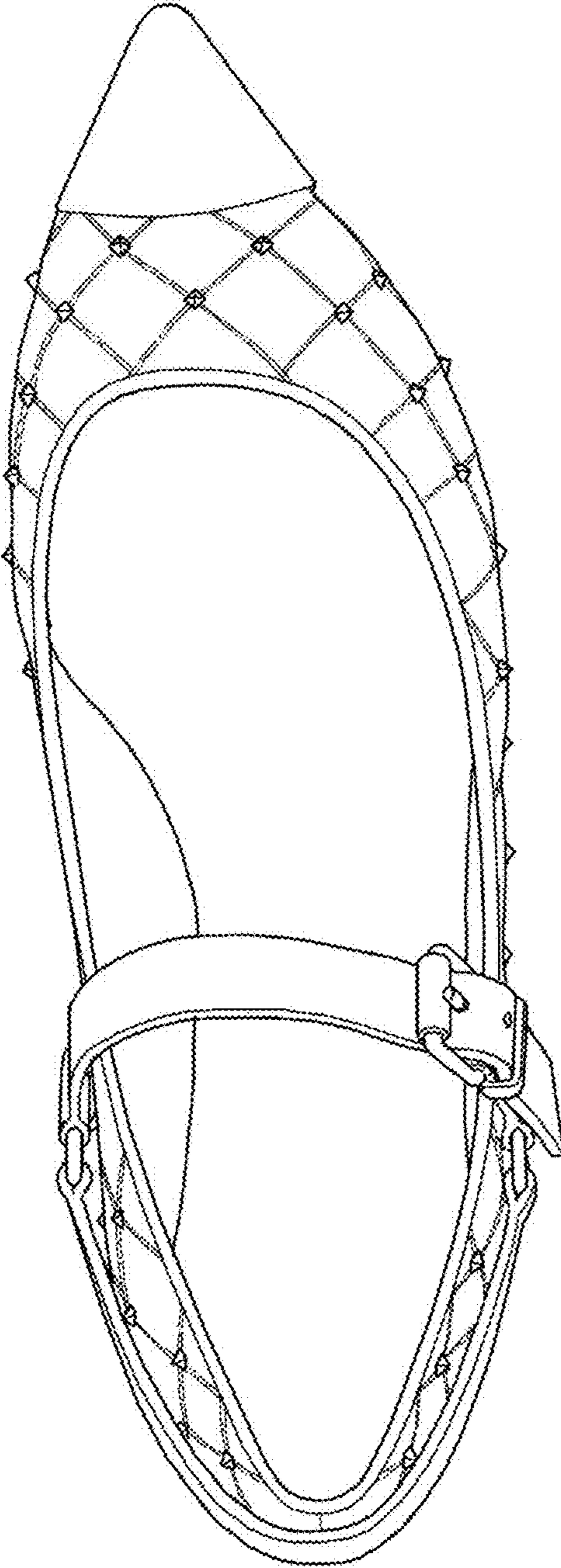

FIG. 6



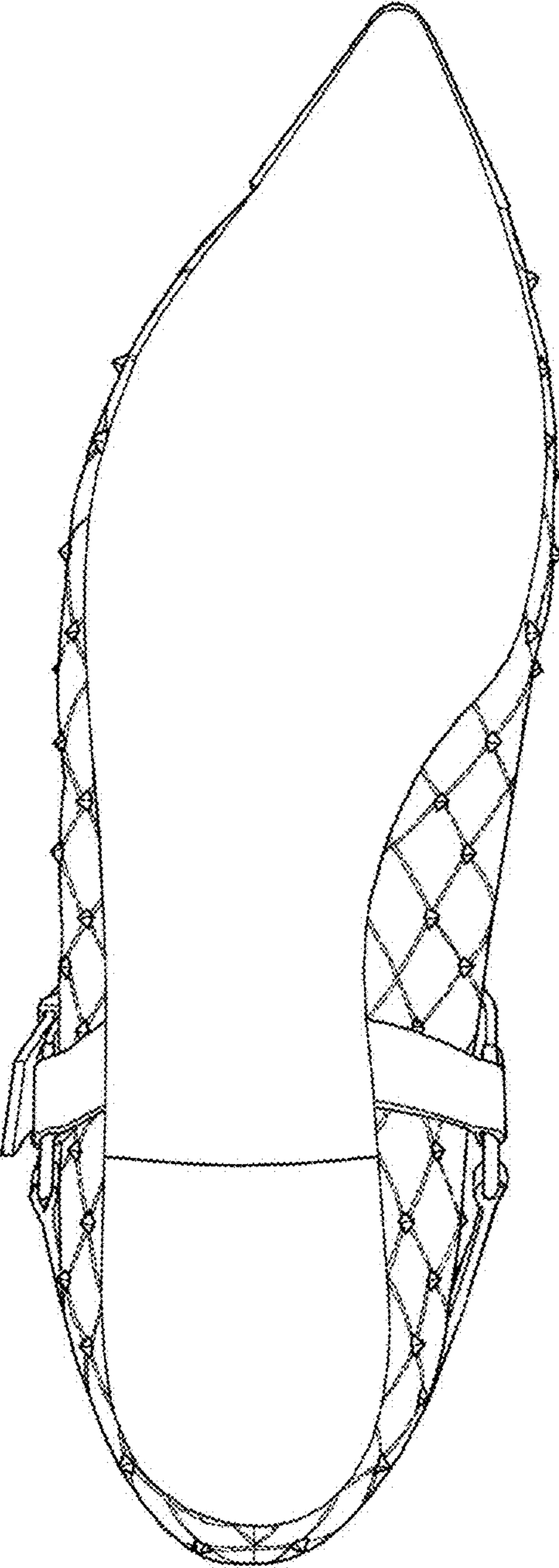

FIG. 7